

047C3014

047C3014

Instructions

Circuit breakers type CTI 15 and auxiliary contact type CBI

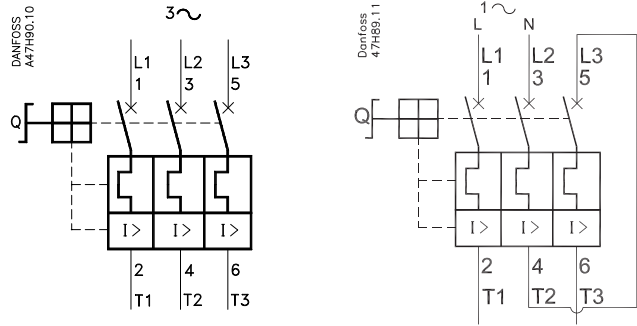
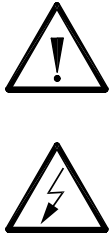

For single-phase applications set to 105% of motor current.

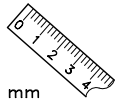

mm

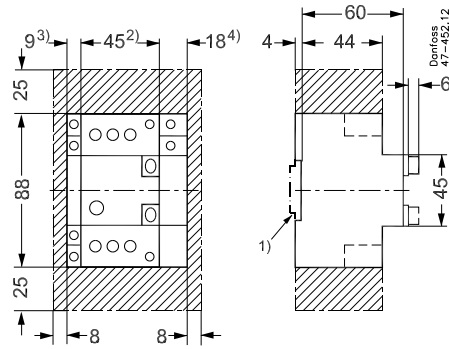

- 1) EN 50022
- 2) CTI 15
- 3) CBI - 11
- 4) CBI - UA / AA



Install accessories before mounting on DIN-rail

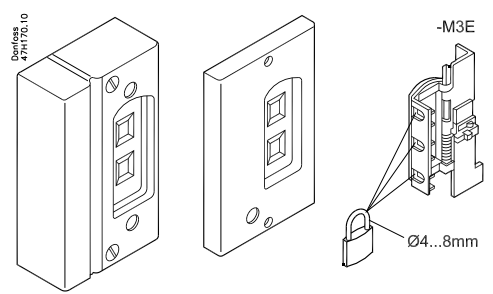
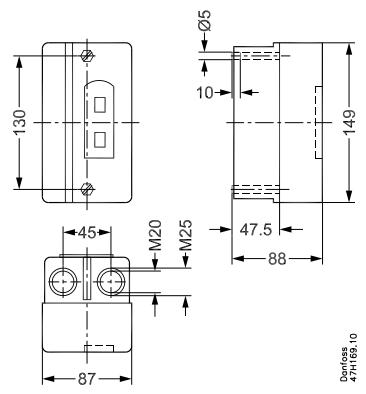
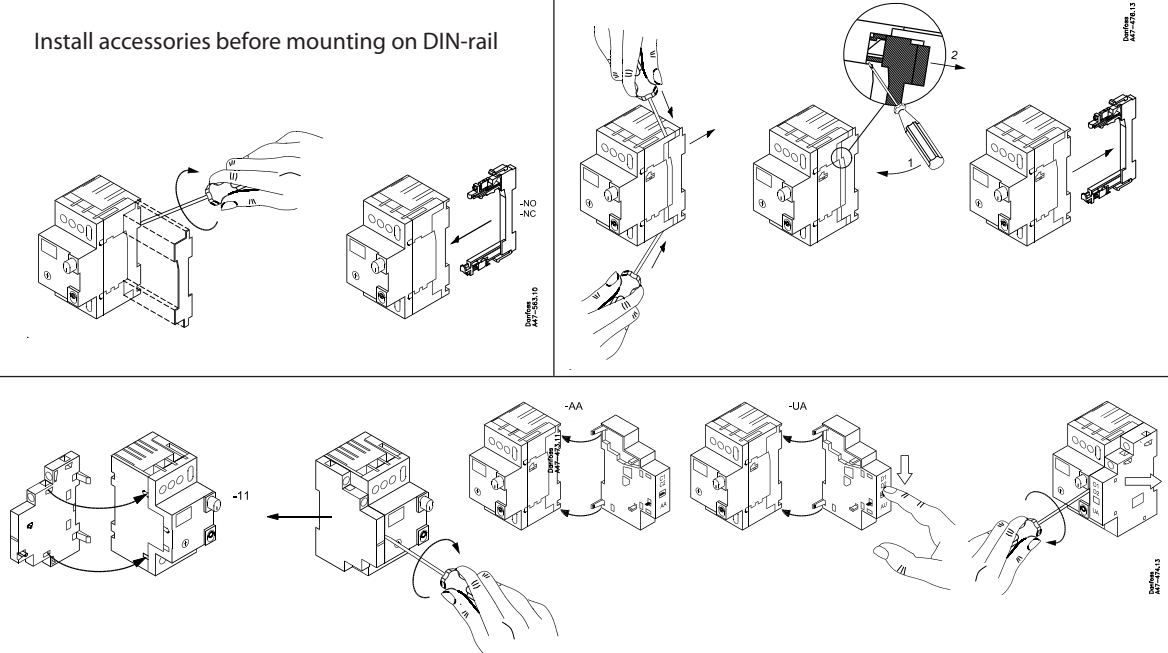

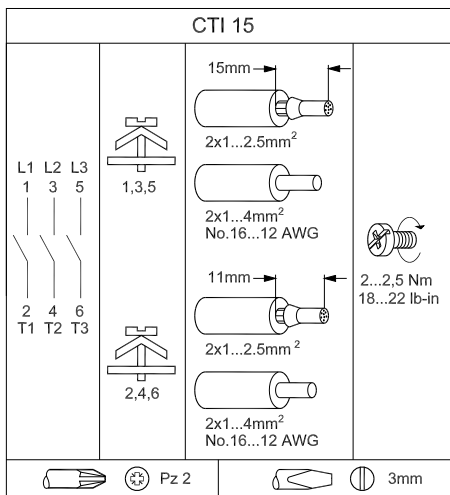

Danfoss
47H164.14

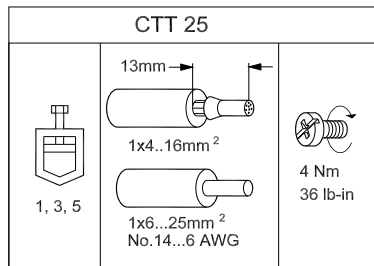

Danfoss
47H165.11

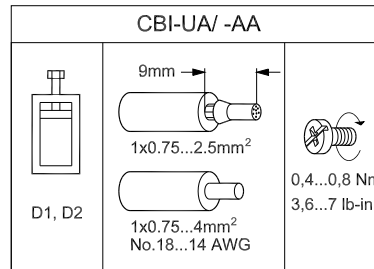

Danfoss
47H166.12

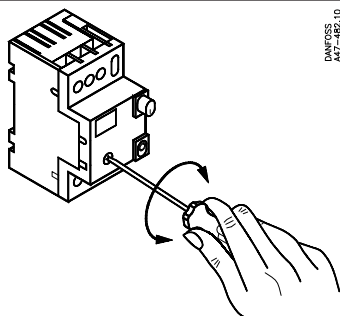
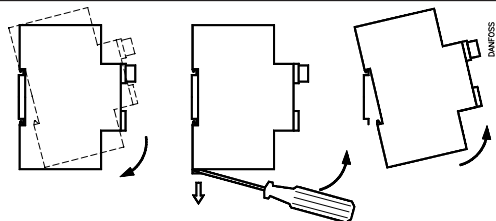
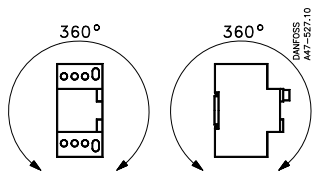

Do not set outside the scale.

CTI 15		230-240 V	400 /415 V	500 V	690 V
		gG, aM	gG, aM	gG, aM	gG, aM
0.16	0.1 - 0.16 A				
0.25	0.16 - 0.25 A				
0.4	0.25 - 0.4 A				
0.63	0.4 - 0.63 A				
1.0	0.63 - 1.0 A				
1.6	1.0 - 1.6 A				
2.5	1.6 - 2.5 A				25 A
4.0	2.5 - 4.0 A				35 A
6.3	4.0 - 6.3 A			63 A	—
10	6.3 - 10 A		63 A	50 A	—
16	10 - 16 A	50 A	50 A	50 A	—

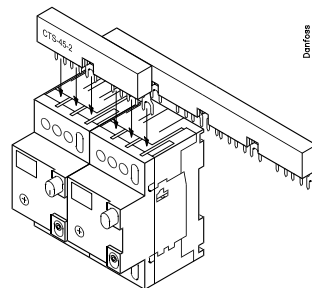
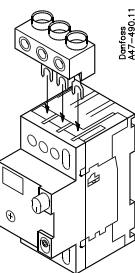

Warning
Opening of branch circuit protective device may indicate that a fault current has been interrupted. To reduce the risk of fire or electric shock current carrying parts or other components of the controller should be examined and replaced if damaged. If burnout of the current elements occurs the complete overload relay must be replaced.

Suitable for use on circuits capable of delivering not more than

CTI 15	RMS sym. amperes at 600 V	RMS sym. amperes at 480 V
To 1.6	42 kA	42 kA
To 2.5	10 kA	42 kA
To 6.3	5 kA	18 kA
To 10	5 kA	10 kA
To 16	5 kA	5 kA

Group installation 175 A max.

CI - contactors are suitable for group installation at 600 V or less when used with CTI 15.