

Type TUH / TCHE

068R9798

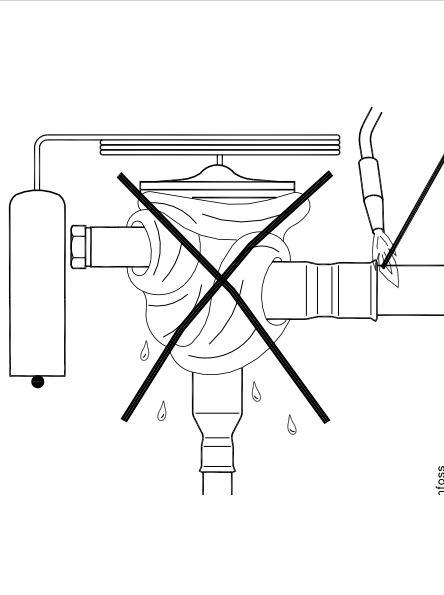

Danfoss
A6B003.10

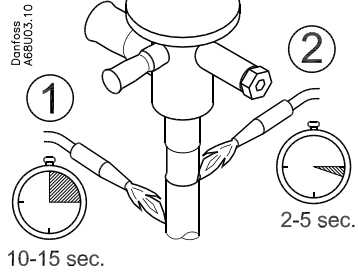

Danfoss
68U04.11.11

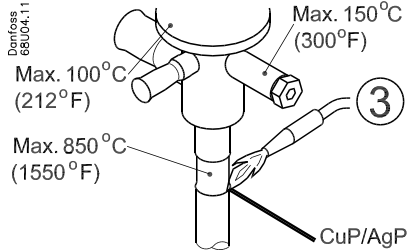

$P_{test} = \text{max. } 37.5 \text{ bar (540 psig)}$

Danfoss
R64-11003.14

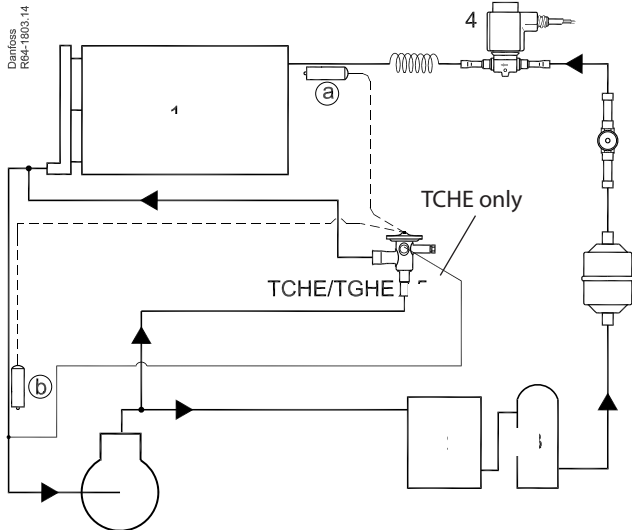

068R9798

Setting of TUH / TCHE

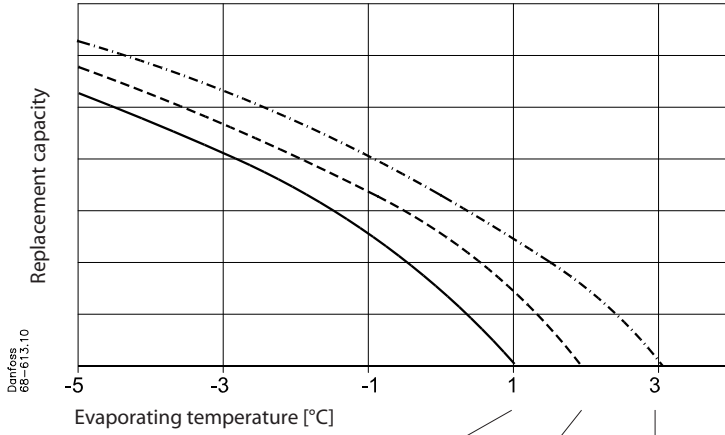

Lower setting

Factory setting

Higher setting

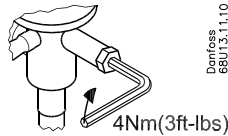
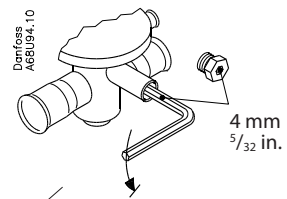
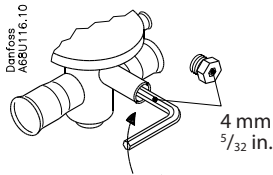

Valve type	°C / turn				
	R134a	R404A/R507	R407C	R410A	R22
TUH	1.8	1	1.2	0.7	1.1
TCHE	1.4	0.8	1	1.4	1