

# Instructions

## VFU 2, VFU 21

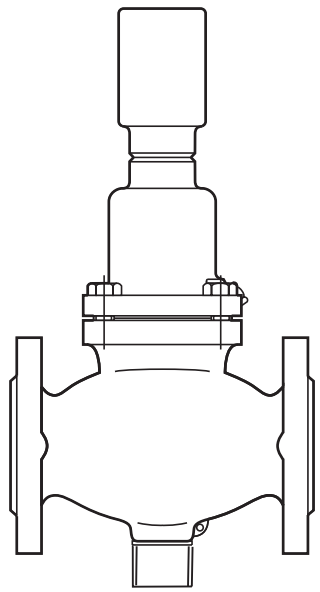

**VFU 2**  
**VFU 21**

+

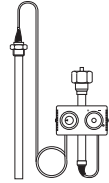

**AFT 06, AFT 17**

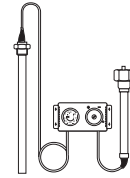

**AFT 26, AFT 27**

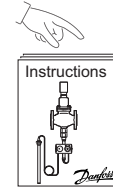

**AFT 06, 26, 17, 27**

+

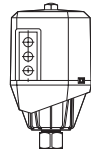

**AMV(E) 410**

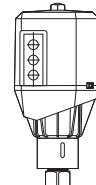

**AMV(E) 413**

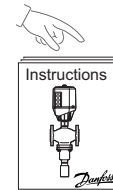

**AMV(E) 410, 413**

+

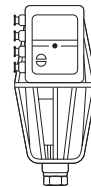

**AMV(E) 610, 613, 633**

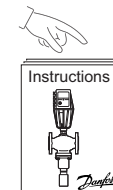

**AMV(E) 6..**

+

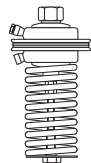

**SAF**

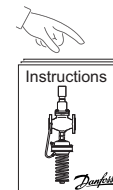

**VFU 21 / SAF**

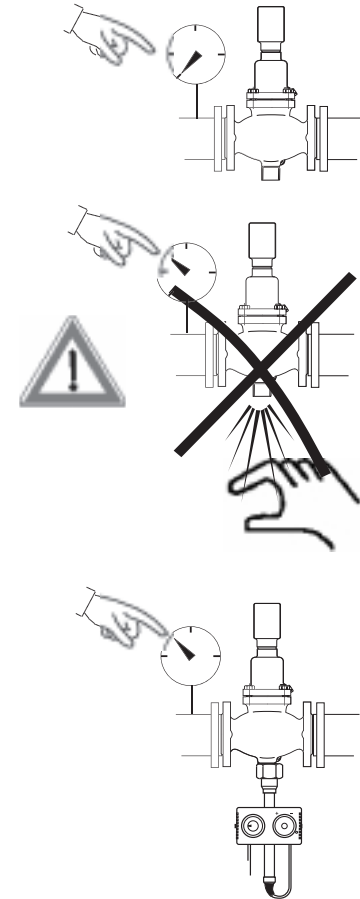

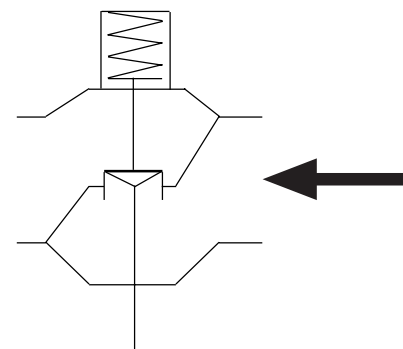
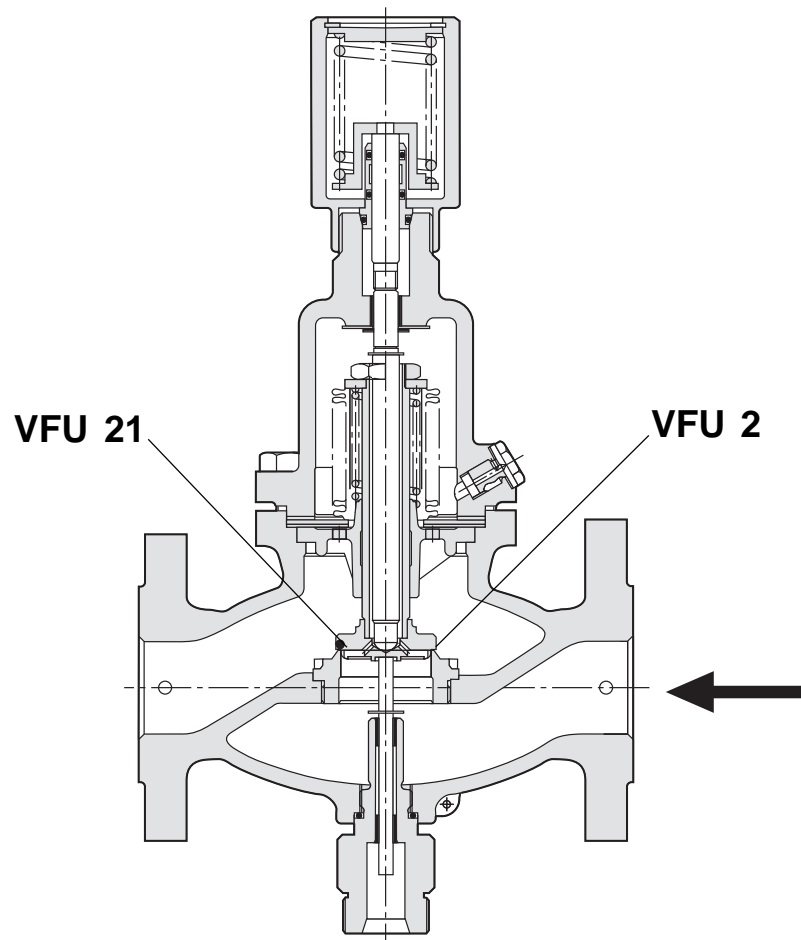

**NC**

