



Instructions AK-PC 560

REFRIGERATION AND
AIR CONDITIONING



084R8036



RI8PM102

Identification

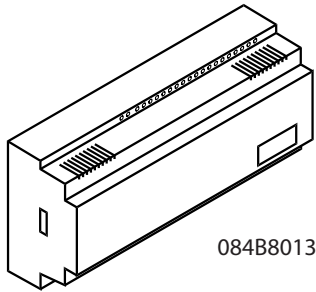

084B8013

Dimensions

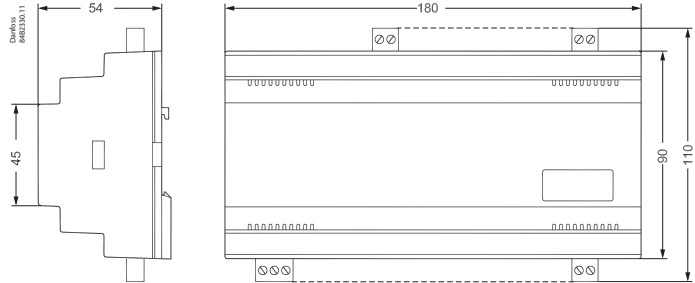

Principle

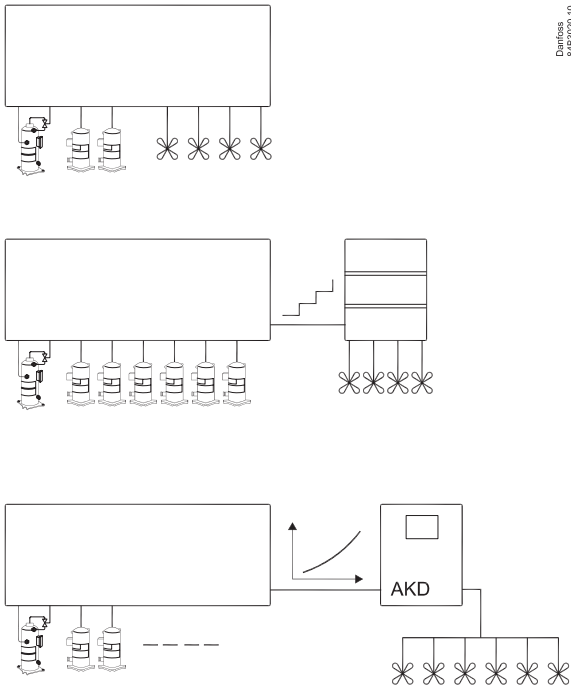

Danfoss
84B3020.10

Danfoss
84B3019.10

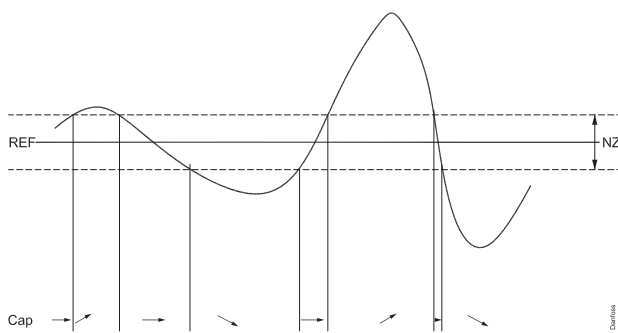
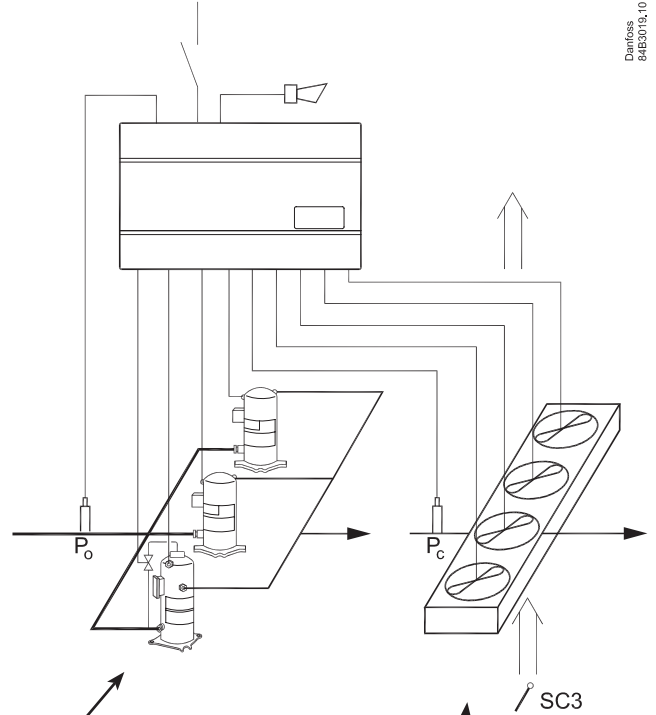

NZ control

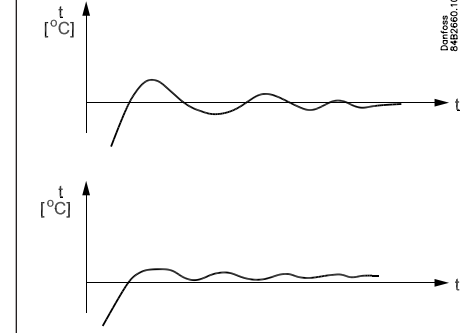

PI or P control

Danfoss
84B2860.10

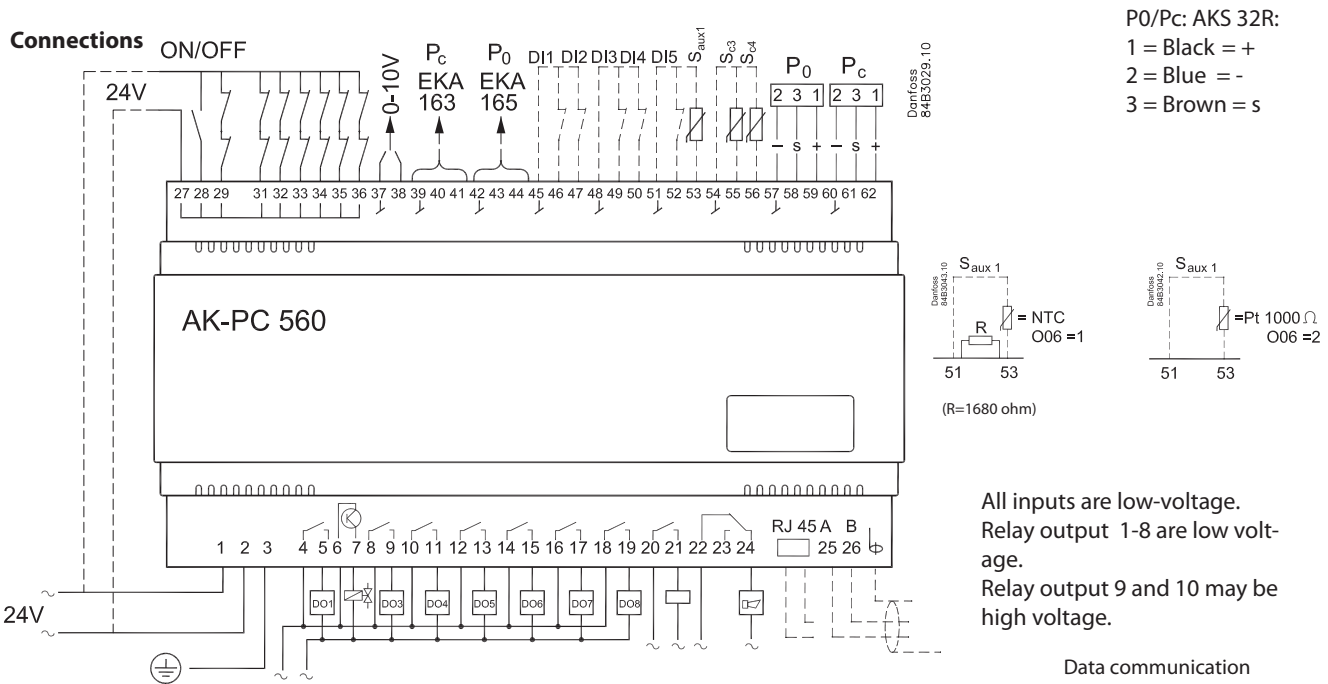

Necessary connections

Terminals:

- 1-2 Supply voltage 24 V a.c.
 - 4-5 Relay outputs for digital scroll compressor
 - 6-7 Solid state relay for digital scroll compressor's unloader
 - 8- 19 Relay outputs for either compressors or fan motors
 - 22-24 Alarm relay *
- There is connection between 22 and 24 in alarm situations and when the controller is dead

- 27-28 4 V signal to start / stop of regulation
- 27-29 24 V signal from the safety circuit Digital scroll
- 30 No function
- 27-31 24 V signal from the safety circuit DO 3
- 27-32 24 V signal from the safety circuit DO 4
- 27-33 24 V signal from the safety circuit DO 5
- 27-34 24 V signal from the safety circuit DO 6
- 27-35 24 V signal from the safety circuit DO 7
- 27-36 24 V signal from the safety circuit DO 8
- 57-59 Suction pressure. Voltage signal from AKS 32R **
- 60-62 Condenser pressure. Voltage signal from AKS 32R **

Application dependent connections

- 20-21 AKD start/stop *
The relay cutin when the frequency converter have to start.
- 37-38 Voltage signal to external condenser control (see settings page 12)
- 39-41 Possibility of connecting an external display type EKA 163 or display of Pc
- 42-44 Possibility of connecting an external display type EKA 163 for display of P0, or EKA 165 for operation and display of P0
- 45-46 DI1 - Contact function for alarm signal
- 45-47 DI2 - Contact function for alarm signal
- 48-49 DI3 - Contact function for alarm signal
- 48-50 DI4 - Contact function for displacement of the suction pressure reference or for alarm signal.
- 51-52 DI5 - Contact function for displacement of the condenser pressure reference or for alarm signal.
- 51-53 Separate sensor Saux. Discharge gas temperature. Sensor signal from Pt 1000 (AKS 21) or Copeland-NTC and with supplied resistor mounted.
- 54-55 Outdoor ambient temperature (Sc3). Sensor signal from Pt 1000, AKS 11 or AKS 21 (mounted if r33 = 2 or 4).
- 54-56 Air temperature at condenser outlet. Sensor signal from a Pt 1000, AKS 11 or AKS 21.

Data communication

- 25-26 Mount only, if a data communication module has been fitted.
For ethernet communication the plug connection RJ45 must be used. (LON FTT10 can also be connected in this way.
It is important that the installation of the data communication cable be done correctly. Cf. separate literature No. RC8AC.

*) Relays DO9 and DO10 may in special cases be reconfigured so that they can be used as fan relays.

**) If the controller has to control only the compressor or the fans, respectively Pc and P0 sensor can be dispensed

Compressor configuration when o61 = 1 or 2 (This is where you can choose between the options shown.)

Setting "c16" will define the configuration.

Setting "c08" will define coupling mode.

Compressor connections								Coupling mode	
Relay no.								Set "c16" to	Set "c08" to
1	2	3	4	5	6	7	8		
1								1	-
1		2						2	-
1		2	3					3	1 / 2
1		2	3	4				4	1 / 2
1		2	3	4	5			5	1 / 2
1		2	3	4	5	6		6	1 / 2
1		2	3	4	5	6	7	7	1 / 2

Danfoss
84B3031-10

Capacity step

All capacity steps are presumed to be identical.

Coupling mode

Coupling mode 1 = *sequential* operation.

Compressor 1 will be the first to start. Then compressor 2 and so on.

Coupling mode 2 = *cyclic* operation.

Compressor 1 will always be in operation when cooling is required. After this the compressor with the lowest number of operating hours will be started.

The capacity from the digital scroll compressor

The capacity is divided into period times as "PWM per". 100% capacity is delivered when cooling takes place for the whole period. An off time is required by the by-pass valve within the period and an on time is also permitted. There is "no cooling" when the valve is on.

The controller itself calculates the capacity needed and will then vary it according to the cut-in time of the by-pass valve.

A limit is introduced if low capacity is needed so that the cooling does not go below 10%. This is because the compressor can cool itself. This value can be increased if necessary.

The capacity can similarly be limited so that the compressor cannot deliver 100% capacity. It is not normally necessary to limit this max. capacity.

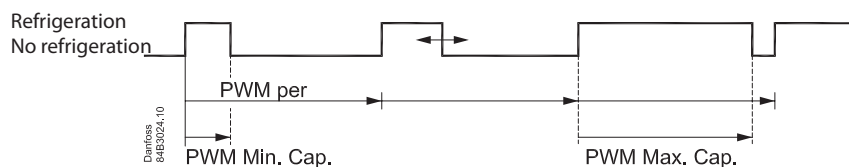

Condenser couplings

When the compressor relays have been established the turn comes to the fan relays.

The first vacant relay (DO3-DO8) will become the first fan relay. It will be followed by the subsequent relays. If more relays are required than the vacant DO relays, a relay module can be connected to the analog output. The function is, as follows:
If there are up to four external fans on an EKC 331:

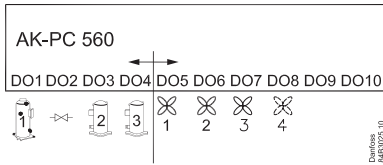

If there are more than four external fans on two EKC 331 units:

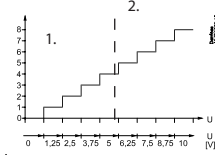

Output signal from AK-PC 560

In the first EKC 331, set 0-5 V ("o10" = 6).

In the second EKC 331, set 5-10 V ("o10" = 7).

In **both** EKC's the number of steps must be set to **4** ("o19" = 4) (also when fewer fans are connected to the second EKC).

Connection

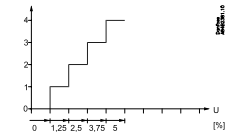
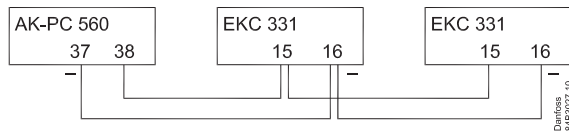

Output signal from AK-PC 560

In EKC 331 the voltage range must be set to 0-5 V ("o10" = 6).

In EKC 331 the number of steps must be set to **4** ("o19" = 4) (also when fewer fans are connected).

Connection

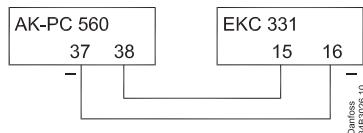

Alternating start-up of fans (only if c29 is 11 to 18)

The fans can be defined to start alternately when they have all been stopped.

The first time regulation is started, fan 1 will be started first – the regulation determines whether additional fans will be started.

After the next time all fans are stopped, fan 2 will be the first to be started, and so on.

Fan 1 will again be the first fan to be started when the rotation has been through the total number of fans.

If there is more than one fan on an EKC 331, it will not be possible to start the other fans first. Here, the fan with the lowest voltage step will always be the one which is started first.

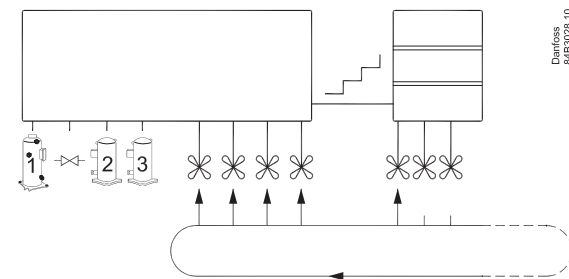

If the entire condenser capacity is to be controlled by a frequency converter, AK-PC 560 must send an analog signal about the required capacity ("c29" = 9).

The signal varies from 0 to 10 V. Signal and capacity have the following context.

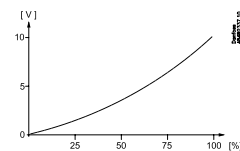

Operation

Data communication

If the controller is extended with data communication, the operation can be performed from a system unit.

The importance of the alarms that are sent can be defined with the setting: 1 (High), 2 (Medium), 3 (Low) or 0 (No alarm).

Operation via external display

The values will be shown with three digits, and with a setting you can determine whether the pressures are to be shown in SI units (°C / bar) or US units (°F / psig.).

There are three options for the display.

EKA 165

EKA 163

EKA 164

EKA 165

To operate the controller and view the evaporation pressure. If the lowermost key is pressed, the condensation pressure will be shown briefly in the display. (If regulation is based only on the condensation pressure, the display will always show Pc).

During normal operation the light-emitting diodes in the display will indicate where regulation is taking place.

Second highest	:	Over neutral zone
"None"	:	Neutral zone
Second lowest	:	Under neutral zone

The other LEDs on the display will show the functions that are active:

- Relays for compressors
- The capacity can be read from the digital scroll compressor
- Relays for fans
- Input signals for the digital inputs
 - The optimization LED will light up when the reference is 2 K or more over the set point.

EKA 163

If the condensation pressure is to be shown constantly, a display without operating keys can be connected.

EKA 164

To operate the controller and view the evaporation pressure. If the lowermost key is pressed, the condensation pressure will be shown briefly in the display. Like the EKA 165, the LEDs in the display will show where the regulation is located.

The buttons on the display

When you want to change a setting, the upper and the lower buttons will give you a higher or lower value depending on the button you are pushing. But before you change the value, you must have access to the menu. You obtain this by pushing the upper button for a couple of seconds - you will then enter the column with parameter codes. Find the parameter code you want to change and push the middle button. When you have changed the value, save the new value by once more pushing the middle button.

Or short:

1. Push the upper button (long push) until a parameter is shown
2. Push one of the buttons and find the parameter you want to change
3. Push the middle button until the setting value is shown
4. Push one of the buttons and select the new value
5. Push the middle button again to conclude the setting

(A brief pushing will show the active alarm codes.)

Menu survey

Sequence

1. o61 **must** be set as the first parameter. This parameter determines which of the four operating interfaces (application mode) are activated. This **must** be set via the display keys. It cannot be set via data communication. (Active functions are shown below in shaded fields.)
2. Quick- start
To get the system up and running quickly so that cooling can be commenced, start it by setting the following parameters (these parameters can only be set when the regulation is stopped, r12=0): r23, r28, c08, c16, c29, o06, o30, o75, o76 **and finally r12=1**.
3. Once the regulation is under way, you can go through the other parameters and adjust them in situ.

SW: 1.0x

Function	Para- meter	o61 =		Min.	Max.	Factory setting
		1	2			
Normal display						
Shows P0 in EKA 165 (display with buttons)	-	°C	P		°C / bar	
Shows Pc in EKA 163	-	°C	P		°C / bar	
P0 reference						
Neutral zone	r01			0.1°C / 0.1 bar	20°C / 5.0 bar	4.0°C / 0.4 bar
Correction of signal from P0 sensor	r04			-50°C / -5.0 bar	50°C / 5.0 bar	0.0
Select view; SI or US. 0=SI (bar / °C), 1=US (Psig / °F)	r05			0	1	0
Start/Stop of regulation	r12			OFF	ON	OFF
Reference offset for P0 (see also r27)	r13			-50°C / -5.0 bar	50°C / 5.0 bar	0.0
Set regulation set point for P0	r23			-99°C / -1 bar	30°C / 60.0 bar	0.0°C / 3.5 bar
Shows total P0 reference (r23 + various displacements)	r24				°C / bar	
Limitation: P0 reference max. value (also applies to regulation with reference displacement)	r25			-99°C / -1.0 bar	30°C / 60.0 bar	30.0°C / 40.0 bar
Limitation: P0 reference min. value (also applies to regulation with reference displacement)	r26			-99°C / -1.0 bar	30°C / 40.0 bar	-99.9°C / -1.0 bar
Displacement of P0 (ON=active "r13")	r27			OFF	ON	OFF
Pc reference						
Set regulation set point for Pc	r28			-25°C / 0.0 bar	75°C / 110.0 bar	35°C / 15.0 bar
Shows total Pc reference	r29				°C / bar	
Limitation: Pc reference max. value	r30			-99.9°C / -0.0 bar	99.9°C / 130.0bar	55.0°C / 60.0 bar
Limitation: Pc reference min. value	r31			-99.9°C / 0.0 bar	99.9°C / 60.0 bar	-99.9°C / 0.0 bar
Correction of signal from Pc sensor	r32			-50°C / -5.0 bar	50°C / 5.0 bar	0.0
Pc reference variation. 1 and 2 are PI-regulation 1: Fixed reference. "r28" is used 2: Variable reference. Outdoor temperature (Sc3) included in the refer- ence 3: As 1, but with P-regulation (Xp-band) 4: As 2, but with P-regulation (Xp-band)	r33			1	4	1
Reference offset for Pc	r34			-50°C / -5.0 bar	50°C / 5.0 bar	0.0
The mean temperature difference across the condenser at maximum load (dim tm K)	r35			3.0	50.0	10.0
The mean temperature difference across the condenser at the lowest relevant compressor capacity (min tm K)	r56			3.0	50.0	8.0
Capacity						
Min. ON time for relays	c01			0 min	30 min.	0
Min. time period between cutins of same relay	c07			2 min.	60 min	2
Definition of regulation mode 1: Sequential (step mode / FILO) 2: Cyclic (step mode / FIFO)	c08			1	2	1
Definition of compressor connections. See options on page 3.	c16			1	7	1
Definition of condenser: 1-8: Total number of fan relays or voltage step on the voltage output 9: Only via analog output and start of frequency converter 10: Not used 11- 18: Total number of fan relays which are to be connected with alter- nating start-up.	c29			0/OFF	18	0
Cut in compressor capacity with manual control. See also "c32"	c31			0%	100%	0
Manual control of compressor capacity (when ON, the value in "c31" will be used)	c32			OFF (0)	ON (1)	OFF (0)

To be continued

Pump down limit. Limit value where the last compressor is cut out.	c33			-99.9°C / -1.0 bar	100°C / 60 bar	100°C / 60 bar
Time delay for incorrect cut-out, compressor 1	c77			0 s	240 s	60 s
Time delay for incorrect cut-out, compressor x; x=2, 3 and so on.	c78			0 s	240 s	60 s
Pulse width period for the digital scroll modulation	c79			10 s	30 s	20 s
Max. capacity in the pulse width period	c80			50 %	100 %	100 %
Min. capacity in the pulse width period	c81			10 %	50 %	10 %
Kp factor for PI regulation of the digital scroll	c82			2	20	5
Tn factor for PI regulation of the digital scroll	c83			40 s	300 s	50 s
The digital scroll's capacity compared to one of the other compressors	c84			100%	200%	100%
Proportional band Xp for (P= 100/Xp) condenser regulation	n04			0.2 K / 0.2 bar	40.0 K / 10.0 bar	10.0 K / 3.0 bar
l: Integration time Tn for condenser regulation	n05			30 s	600 s	150
Cutin condenser capacity with manual control. See also "n53"	n52			0%	100%	0
Manual control of condenser capacity (when ON, the value in "n52" will be used)	n53			OFF (0)	ON (1)	OFF (0)
Start speed The voltage for the speed regulation is kept at 0V until the regulation requires a higher value than the value set here.	n54			0%	75%	20%
Min. speed. The voltage for the speed regulation switches to 0V when the regulation requires a lower value than the value set here.	n55			0%	50%	10%
Alarm						
Delay time for a A32 alarm	A03			0 min.	90 min.	0 min.
Low alarm and safety limit for P0	A11			-99°C / -1.0 bar	30°C / 40 bar	-40°C / 0.5 bar
Delay time for a DI1 alarm	A27			0 min. (-1=OFF)	480 min.	OFF
Delay time for a DI2 alarm	A28			0 min. (-1=OFF)	480 min.	OFF
Delay time for a DI3 alarm	A29			0 min. (-1=OFF)	480 min.	OFF
Upper alarm and safety limit for Pc	A30			-10 °C / 0.0 bar	200°C/200 bar	60.0°C / 60.0 bar
Upper alarm limit for sensor "Saux1" If a higher value is measured then the digital scroll stops.	A32			1°C (0=OFF)	150°C	130°C
Delay time for a P0 alarm	A44			0 min. (-1=OFF)	480 min.	0 min.
Delay time for a Pc alarm	A45			0 min. (-1=OFF)	480 min.	0 min.
Miscellaneous						
Controllers address	o03*			1	240	
On/off switch (service-pin message)	o04*			-	-	
Access code	o05			1 (0=OFF)	100	OFF
Used sensor type for Saux 1=Internal Copeland NTC. (A fixed resistor must also be fitted.) 2=Pt 1000	o06			1	2	1
Set supply voltage frequency	o12			50 Hz (0)	60 H (1)	50Hz (0)
Manual control of outputs: 0: No override 1-10: 1 will cut in relay 1, 2 relay 2, etc. 11-18: Gives voltage signal on the analog output. (11 gives 1.25 V, and so on in steps of 1.25 V	o18			0	18	0
P0 pressure transmitter's working range - min. value	o20			-1 bar	5 bar	-1.0
P0 pressure transmitter's working range - max. value	o21			6 bar	199 bar	12.0
Use of DI4-input 0=not used. 1=P0 displacement. 2=alarm function. Alarm="A31"	o22			0	2	0
Operating hours of relay 1 (value time 1000)	o23			0.0 h	99.9 h	0.0
Operating hours of relay 3 (value time 1000)	o25			0.0 h	99.9 h	0.0
Operating hours of relay 4 (value time 1000)	o26			0.0 h	99.9 h	0.0
Setting of refrigerant 1=R12. 2=R22. 3=R134a. 4=R502. 5=R717. 6=R13. 7=R13b1. 8=R23. 9=R500. 10=R503. 11=R114. 12=R142b. 13=User defined 14=R32. 15=R227. 16=R401A. 17=R507. 18=R402A. 19=R404A. 20=R407C. 21=R407A. 22=R407B. 23=R410A. 24=R170. 25=R290. 26=R600. 27=R600a. 28=R744. 29=R1270. 30=R417A. 31=R422A. 32=R413A. 33=R422D. 34=R427A. 35=R438A. 36=XP10. 37=R407F	o30			0	37	0
Use of DI5-input 0=not used. 1=Pc displacement. 2=alarm function. Alarm="A32"	o37			0	2	0
Pc pressure transmitter's working range - min. value	o47			-1 bar	5 bar	-1.0
Pc pressure transmitter's working range - max. value	o48			6 bar	199 bar	34.0
Operating hours of relay 5 (value time 1000)	o50			0.0 h	99.9 h	0.0
Operating hours of relay 6 (value time 1000)	o51			0.0 h	99.9 h	0.0
Operating hours of relay 7 (value time 1000)	o52			0.0 h	99.9 h	0.0

* this setting is only possible if data communication module is mounted in the controller

Operating hours of relay 8 (value time 1000)	o53			0.0 h	99.9 h	0.0
Selection of application 1. Show temperature and "c16" mode 2. Show pressure and "c16" mode	o61	1	2	1	2	1
Function for relay output DO9: 0. Start / stop of speed regulation 1. Inject on signal for evaporator control 2. Boost ready (at least one compressor is on) 3. Start /stop of condenser fan	o75			0	3	0
Function for relay output DO10: 0. Alarm relay 1. Start / stop of condenser fan	o76			0	1	0
Definition of alarm message at DI1 signal: 0. Not used 1. Fan failure (A34) 2. DI1 alarm (A28)	o78			0	2	0
Display connection Off: EKA 164 On: EKA 165 (extended display with light-emitting diodes)	o82			Off	On	Off
Service						
Temperature at Saux (discharge gas temperature)	u03					
Status on DI1 input	u10					
Status on DI2 input	u37					
Read temperature at sensor "Sc3"	u44					°C
Read temperature at sensor "Sc4"	u45					°C
Status on DI3 input	u87					
Status on DI4 input	u88					
Status on DI5 input	u89					
Read regulation capacity in % of the digital scroll	U28					

The controller can give the following messages			
E1	Error message	Fault in controller	
E2		Regulation is outside the range, or the control signal is defective	
A2	Alarm message	Low P0	
A11		Refrigerant not selected	
A17		High Pc	
A19		Compressor 1 error (29)	The actual compressors safety circuit is interrupted. That is to say the signal is missing on one of the terminals 29-36
A20		Compressor 2 error (31)	
A21		Compressor 3 error (32)	
A22		Compressor 4 error (33)	
A23		Compressor 5 error (34)	
A24		Compressor 6 error (35)	
A25		Compressor 7 error (36)	
A27		Saux discharge gas temperature to high . Digital scroll is stopped	
A28		DI 1 alarm. Terminal 46 interrupted	
A29		DI 2 alarm. Terminal 47 interrupted	
A30		DI 3 alarm. Terminal 49 interrupted	
A31		DI 4 alarm. Terminal 50 interrupted	
A32	DI 5 alarm. Terminal 52 interrupted		
A34	Fan alarm. There is no signal on DI1 input		
A45	Regulation stopped		
S0	Status message	Regulation	
S2		Wait for "c01"	
S5		Wait for "c07"	
S10		Refrigeration stopped by the internal or external start/stop function	
S25		Manual control of outputs	
S34		Safety cutout. Setting A30 is exceeded or all safety inputs (29-36) are open	
PS	Info	Access code is required before you have access to the settings	

Messages can be brought up on the display by briefly pressing the uppermost key. If there is more than one alarm, they can be scrolled through

Factory setting

If you need to return to the factory-set values, it can be done in this way:

- Cut out the supply voltage to the controller
- Keep the middle button pressed at the same time as you reconnect the supply voltage

