

Data sheet

Circuit Breakers, Type CTI 25M, CTI 45MB, CTI 100



Circuit breakers for short circuit and overload protection of motor applications cover together with the circuit breaker CTI 100 the current range 0.1 - 90 A (AC-3 rating). The product range is split in three product sizes. The smallest size is CTI 25M. It consists of 14 code numbers and covers the current range 0.1 - 32 A. The bigger size is called CTI 45MB. It consists of one code number and covers the current range from 32 - 45 A. The biggest size is CTI 100 consists of two code numbers and covers the current range from 40 - 90 A.

The program is very flexible and includes add-on accessories such as auxiliary contacts, alarm contacts, voltage and under voltage trips, connection terminals and bus bars.

Features

- Overload protection and short circuit protection of motor installations
- Test function for thermal trip
- Manual reset function
- Indication for thermal trip
- Indication for magnetic trip (short circuiting)
- Single phase protection (Differential trip)
- Temperature compensated (-20°C - +60°C)
- Tripping class 10

Circuit Breakers CTI 25M, CTI 45 MB, CTI 100

Approvals

Product type	Approval institute				UK	Germany	France
	EN 60947	Canada	USA	Lloyds Register of Shipping	Germanischer Lloyd	Bureau Veritas	
CTI 25M	●	●	●	□	□	□	
CTI 45MB	●	●	●	□	□	□	
CBA-	●	●	●	□	□	□	
CBA S-	●	●	●	□	□	□	
CBT-	●	●	●	□	□	□	
CBT S-	●	●	●	□	□	□	
VTU-	●	●	●	□	□	□	
VTU 2EM-	●	●	●	□	□	□	
VT-	●	●	●	□	□	□	
BLK	●	●	●	□	□	□	
RLK	●	●	●	□	□	□	
BDH	●	●	●	□	□	□	
RDH	●	●	●	□	□	□	
BMP	●	●	●	□	□	□	
RMP	●	●	●	□	□	□	
BBT-	●	●	●	□	□	□	
BBC-	●	●	●	□	□	□	
CTI 100	●	●	●	●	●	●	
CBI 100-	●	●	●	●	●	●	
CBI 100 UI-	●	●	●	●	●	●	
CBI 100 UA-	●	●	●	●	●	●	
CBI 100 AA-	●	●	●	●	●	●	
CTC	●	●	●	□	□	□	

- Approved
- Approvals applied for

Ordering

Circuit Breakers / Manual Motor Starters CTI 25M, CTI 45MB, CTI 100

Type	AC-3 Load 380 - 415 V [kW]	Range Motor Starter [A]	Electromagnetic Trip current [A]	Code number
CTI 25M	0.02	0.1 - 0.16	2.1	047B3140
	0.06	0.16 - 0.25	3.3	047B3141
	0.09	0.25 - 0.40	5.2	047B3142
	0.18	0.4 - 0.63	8.2	047B3143
	0.25	0.63 - 1.0	13	047B3144
	0.55	1.0 - 1.6	21	047B3145
	0.75	1.6 - 2.5	33	047B3146
	1.5	2.5 - 4.0	52	047B3147
	2.2	4.0 - 6.3	82	047B3148
	4.0	6.3-10	130	047B3149
	7.5	10 - 16	208	047B3150
	10	14.5 - 20	260	047B3151
	11	18 - 25	325	047B3152
13	24 - 29	406	047B3103	
15	27 - 32	448	047B3102	
CTI 45 MB	22	32 - 45	585	047B3165
CTI 100	31.5	40 - 63	882	047B3014
	45	63 - 90	1260	047B3015

Note!

For motors with full load currents higher or equal with 19 A, CTI 25M 047B3152 (18 - 25 A) must be selected.

Circuit Breakers CTI 25M, CTI 45 MB, CTI 100

Ordering

CBA -



CBA S-
CBT S-



VTU



Anti tamper
shield



BLK



BDH
RDH



Door handle
extension



BBT 25



BBT 45

BBC 25



Auxiliary contacts and Alarm contacts to circuit breakers CTI 25M, CTI 45MB

Type	Description		Mounting	Code no.
CBA-10	Auxiliary contact	1 NC (11-12)	Front ¹⁾	047B3198
CBA-11	Auxiliary contact	1 NO+1 NC (13-14, 21-22)	Front ¹⁾	047B3200
CBA-20	Auxiliary contact	2 NO (13-14, 23-24)	Front ¹⁾	047B3201
CBA S-11	Auxiliary contact	1 NO+1 NC (33-34, 41-42)	Side ^{1) 3)}	047B3203
CBT S-TM2	Trip alarm + Magnetic alarm contact	Trip alarm: Make, 55-56, Magnetic alarm: Break, 65-66	Side ^{2) 4)}	047B3211

¹⁾ Max. one per Circuit breaker

²⁾ Can also be mounted together with CBA-S

³⁾ Can also be mounted onto an alarm contact CBT S-

⁴⁾ Always direct onto the circuit breaker

Under voltage and voltage trips to circuit breakers CTI 25M, CTI 45MB

Type	Remarks	Code no.
VTU	Under voltage trip, 24 V/50 Hz-28 V/60 Hz, D1-D2	047B3214
VTU	Under voltage trip, 220-230 V/50 Hz, D1-D2	047B3217
VTU	Under voltage trip, 380-400 V/50 Hz, 440-460 V/60 Hz, D1-D2	047B3220

Accessories for circuit breakers CTI 25M, CTI 45MB

Type	Remarks	Code no.
BLK	Black lockable rotary handle	047B3243
BDH	Black door handle for mounting in panel doors IP66	047B3249
RDH	Red/yellow door handle for mounting in panel doors IP66	047B3250
	Door handle extension rod for CBI 100-BDH	047B3136

Connection terminal blocks and bus bars for circuit breakers CTI 25M, CTI 45MB

Type	Remarks	Spacing	Number of connections	Code No.
BBT 52	Connection terminal block for CTI 25M			047B3259
BBC 25 45-2	Bus bar for CTI 25M	45 mm	2	047B3261
BBC 25 45-3	Bus bar for CTI 25M	45 mm	3	047B3262
BBC 25 45-5	Bus bar for CTI 25M	45 mm	4	047B3263
BBC 25 54-2	Bus bar for CTI 25M	54 mm	2	047B3265
BBC 25 54-3	Bus bar for CTI 25M	54 mm	3	047B3266
BBC 25 54-4	Bus bar for CTI 25M	54 mm	4	047B3267
BBC 25 54-5	Bus bar for CTI 25M	54 mm	5	047B3268

Circuit Breakers CTI 25M, CTI 45 MB, CTI 100

Ordering

CBI 100-
CBI 100 UI-



CBI 100 UA-



CBI 100- LK



Accessories for circuit breaker CTI 100

Type	Remarks	Code no.
CBI 100-20	Auxiliary contact, 2 NO (13-14, 23-24), for front mounting	047B3110
CBI 100-11	Auxiliary contact, 1 NO+1 NC (13-14, 21-22), for front mounting	047B3112
	Door handle extension rod for CBI 100-BDH	047B3136

Circuit Breakers CTI 25M, CTI 45 MB, CTI 100



Enclosures for the circuit breaker CTI 25M is made of deform-resistant grey ABS thermoplast.

The enclosures are available with black rotary handle on a grey background or with red rotary handle on a yellow background.

Circuit breaker type CTI 25M for overload protection of electric motors from 0.1 - 25 A full load current can be mounted into the enclosure.

Features

- Status indication ON-OFF-TRIP
- For maintenance purposes locking facility up to 3 padlocks
- Sealed cover
- High protection degree IP65
- Cable entries top and bottom M20/25
- Mounted with DIN-rail
- Mounted with earth terminal
- Possible installation of auxiliary and trip contacts
- Space for under voltage and voltage trips

Used as:

- Manual motor starter
- Mains isolator
- Maintenance switch
- Emergency switch together with under voltage trip

Used on:

- Small workshops for drilling machines
- Concrete mixer
- Air handling units
- Water booster systems
- Fan systems
- Transport belt

Ordering

Enclosures for CTI 25M

Type	Application	Rotary handle	Cable entries	Code no.
BMG	Motor starter / Main switch	Black/grey	4 M20/25	047B3284
BMY	Motor starter / Emergency switch	Red/grey	4 M20/25	047B3285

Circuit Breakers CTI 25M, CTI 45 MB, CTI 100

Contact symbols for CTI and accessories

Circuit breakers

CTI 25M, CTI 45MB

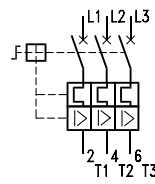

Auxiliary contacts for front mounting

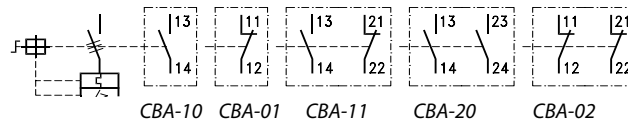

Auxiliary contacts for side mounting

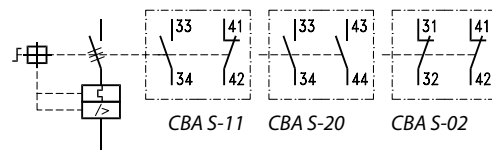

Alarm contacts for side mounting

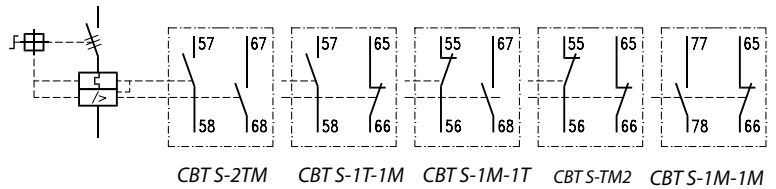

Under voltage trip

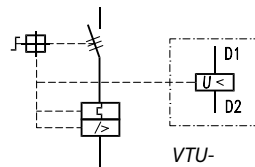

Voltage trip

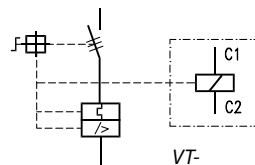

Circuit Breakers CTI 25M, CTI 45 MB, CTI 100

Contact symbols for CTI 100 and accessories

Circuit breaker

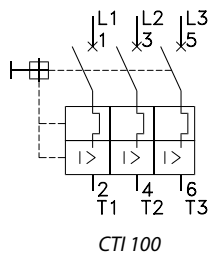

Auxiliary contacts

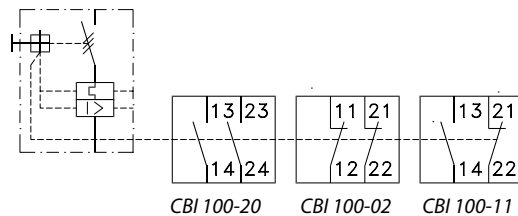

Alarm contacts

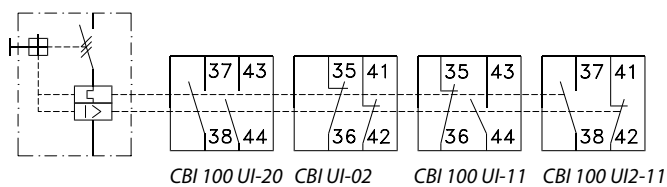

Under voltage trip

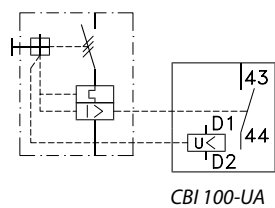

Voltage trip

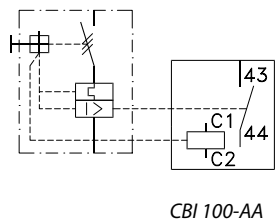

Circuit Breakers CTI 25M, CTI 45 MB, CTI 100

General specifications

Parameters	CTI 25M, CTI 45MB	CTI 100
Isolation voltage IEC, SEV, VDE 0660 UL, CSA	690 V 600 V	
Impulse voltage U _{imp} /pollution degree	6 kV/3	8 kV/3
Rated frequency range	50-60 Hz	40-60 Hz
Ambient temperature: Storage Operation Temperature compensation	-40°C - +80°C -25°C - +60°C -20°C - +60°C	
Utilization category	As circuit breaker IEC 947-2 As motor starter IEC 947-4-1	
Overload protection	Motors	Motors
Trip class	10	10
Magnetic trip	13 × (max. value of setting range)	14 × (max. value of setting range)
Phase failure protection	Yes	Yes
Mechanical operations	100000	30000
Electrical operations	30000	10000 5000 (63-90)
Switching frequency	Max 25 operations/hour	Max 20 operations/hour
Resistance to climate change	according to IEC 68-2	
Site altitude	2000 m N.N	
Protection class	IP20	
Resistance to vibration	IEC 68-2	
Resistance to shock	30g, 11 ms	30 g, 11 ms
Life span	0.1 - 25 A	40 - 90 A
Total power loss	6 - 8 W	33 W

Mounting direction

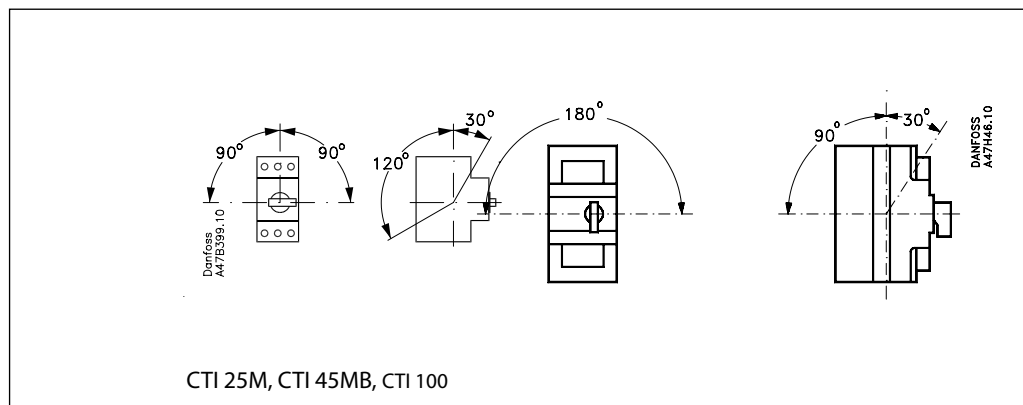

Circuit Breakers CTI 25M, CTI 45 MB, CTI 100

Max. motor load

Circuit breaker for overload and short circuit protection of motor applications CTI 25M, CTI 45MB, CTI 100

Type	Setting [A]	Motor operating voltage – Rated output in [kW]							
		220 - 240 V		380 - 415 V		500 V		690 V	
		AC-2	AC-3	AC-2	AC-3	AC-2	AC-3	AC-2	AC-3
CTI 25M	0.1 - 0.16	-	-	-	0.02	-	-	-	-
	0.16 - 0.25	-	-	-	0.06	-	-	-	-
	0.25 - 0.4	-	-	-	0.09	-	-	-	-
	0.40 - 0.63	0.06	0.09	0.12	0.18	-	0.18	-	0.25
	0.63 - 1.0	-	0.12	-	0.25	0.25	0.37	0.37	0.55
	1.0 - 1.6	0.18	0.25	0.37	0.55	0.55	0.75	0.75	1.1
	1.6 - 2.5	-	0.37	-	0.75	-	1.1	-	1.8
	2.5 - 4.0	0.55	0.75	1.1	1.5	1.5	2.2	2.2	3
	4.0 - 6.3	1.1	1.5	-	2.2	2.5	3	-	4
	6.3 - 10	-	2.2	3	4	4	6.3	5.5	7.5
	10 - 16	3	4	5.5	7.5	7.5	10	11	13
	14.5 - 20	4	5.5	7.5	10	-	11	15	17
	18 - 25	-	5.5	-	11	-	15	18.5	22
	24 - 29	-	7.5	-	13	-	18.5	-	25
27 - 32	-	7.5	-	15	-	20	-	25	
CTI 45MB	32 - 45	11	13	18.5	22	22	30	30	40
CTI 100	40 - 63	12.5	20	25	31.5	30	40	37	55
	63 - 90	22	25	37	45	45	55	63	75

Accessories for circuit breakers CTI 25M

Auxiliary and trip contacts CBA-, CBA S-, CBT S-

Type	Description	lth		AC-15					DC-13			
		40 °C	60 °C	24 V	120 V	220 - 240 V	380 - 415 V	690 V	24 V	120 V	240 V	415 V
		[A]	[A]	[A]	[A]	[A]	[A]	[A]	[A]	[A]	[A]	[A]
CBA-	Auxiliary contacts for front mounting	5	4	4	3	1.5	-	-	2	0.5	0.25	-
CBA S-	Auxiliary contacts for side mounting	10	6	6	5	3	2	0.7	2	0.5	0.25	0.15
CBT S-	Trip contacts for side mounting	10	6	6	5	3	2	0.7	2	0.5	0.25	0.15

Bus bar terminal and Bus bar connection

Type	Description	Max. load lth at 60 °C [A]
BBT 25	Bus bar terminal for CTI 25M	63
BBC 25	Bus bar connection for CTI 25M	63
BBT 45	Bus bar terminal for CTI 45MB	120
BBC 45	Bus bar connection for CTI 45MB	120

Voltage and under voltage trip VT-, VTU-

Type	Description	Operating voltage range	Coil consumption
VT-	Voltage trip 21 V/50 Hz-415 V/50 Hz 24 V/60 Hz-480 V/60 Hz (max 300V UL) Endurance 100%	Pull-in 0.85-1.1xU _S Drop-out 0.7-0.35x U _S	Pull-in: 8.5 VA, 6 W Hold: 3 VA, 1.2 W
VTU-	Under voltage trip 21 V/50 Hz-415 V/50 Hz 24 V/60 Hz-480 V/60 Hz (max 300V UL) Endurance 100%	Pull-in 0.85-1.1xU _S Drop-out 0.7-0.35x U _S	Pull-in: 8.5 VA, 6 W Hold: 3 VA, 1.2 W

Circuit Breakers CTI 25M, CTI 45 MB, CTI 100

Accessories for circuit breaker CTI 100

Auxiliary contacts and alarm contacts CBI 100-, CBI 100 UI-

Type	Description	I _{th}		AC-15				DC-13			
		40 °C [A]	60 °C [A]	220 - 240 V [A]	380 - 415 V [A]	500 V [A]	690 V [A]	24 V [A]	48 V [A]	110 V [A]	220 V [A]
CBI 100-	Auxiliary contact	10	6	3	2.5	1.5	0.75	2	0.6	0.2	0.1
CBI 100 UI-	Alarm contact	10	6	3	2.5	1.5	0.75	2	0.6	0.2	0.1

Alarm contact in undervoltage- and voltage trip

Type	Description	I _{th}		AC-14				DC-13			
		60 °C [A]	24 V [A]	110 V [A]	220 - 240 V [A]	380 - 415 V [A]	500 V [A]	24 V [A]	48 V [A]	60 V [A]	110 V [A]
CBI 100- AA	Voltage trip	2	1.5	1.5	1	1	0.75	1.5	0.5	0.4	0.2
CBI 100- UA	Under voltage trip	2	1.5	1.5	1	1	0.75	1.5	0.5	0.4	0.2

Voltage- and under voltage trip CBI 100-AA and CBI 100-UA

Type	Remarks	Voltage range	Coil consumption
CBI 100-AA	Voltage trip 21 V/50 Hz-415 V/50 Hz Switch-in voltage 24 V/60 Hz-480 V/60 Hz (max 300V UL) Endurance 100%	Switch-in power: 0.85-1.1xU _s Drop-out voltage 0.7-0.35x U _s 3VA, 1.2W	8.5 VA, 6 W Holding power
CBI 100-UA	Under voltage trip 21 V/50 Hz-415 V/50 Hz Switch-in voltage 24 V/60 Hz-480 V/60 Hz (max 300V UL) Endurance 100%	Switch-in power: 0.85-1.1xU _s Drop-out voltage 0.7-0.35x U _s 3VA, 1.2W	8.5 VA, 6 W Holding power

Terminals

Type	Comments	Recommended screwdriver size	Solid wire [mm ²]	Stranded wire [mm ²]	Stranded wire with sleeve [mm ²]	Tightening torque [Nm]
CTI 25M	1 conductor or 2 conductors	Pozi 2/ blade 3	1.5-6	1-6	1-4	1-2.5
CBA-	1 conductor or 2 conductors	Pozi 2/ blade 3	0.75-2.5	0.75-2.5	0.5-2.5	1.5
CBA S-	1 conductor or 2 conductors	Pozi 2/ blade 3	0.75-2.5	0.75-2.5	0.5-2.5	1.5
CBT S-	1 conductor or 2 conductors	Pozi 2/ blade 3	0.75-2.5	0.75-2.5	0.5-2.5	1.5
VT-	1 conductor or 2 conductors	Pozi 2/ blade 3	0.75-2.5	0.75-2.5	0.5-2.5	1.5
VTU-	1 conductor or 2 conductors	Pozi 2/ blade 3	0.75-2.5	0.75-2.5	0.5-2.5	1.5
CBA-	1 conductor or 2 conductors	Pozi 2/ blade 3	0.75-2.5	0.75-2.5	0.5-2.5	1.5
BBT 25	1 conductor	Pozi 2/ blade 3	6-25	6-25	4-16	3
BBT 25	2 conductors	Pozi 2/ blade 3	6-16	6-16	4-10	3
BBT 45	1 conductor	Pozi 2/ blade 4	10-50	10-50	6-35	3
BBT 45	2 conductors	Pozi 2/ blade 4	10-25	10-25	6-16	3
CTI 100	1 conductor	Allen key 5	-	4-50	2.5-35	6-10
CBI 100-	2 conductors	Pozi 2/ blade 3	-	0.75-2.5	0.75-2.5	1-1.5
CBI 100 UI-	2 conductors	Pozi 2/ blade 3	-	0.75-2.5	0.75-2.5	1-1.5
CBI 100 UA-	2 conductors	Pozi 2/ blade 3	-	0.75-2.5	0.75-2.5	1-1.5
CBI 100 AA-	2 conductors	Pozi 2/ blade 3	-	0.75-2.5	0.75-2.5	1-1.5

Circuit Breakers CTI 25M, CTI 45 MB, CTI 100

Short circuit protection

Short circuit coordination is the connection between the specifications of the protection devices, such as fuses, circuit breakers, MCCB and its ability to resist short circuit.

Short circuit coordination type 1

Test demand

O-t-CO

O = Breaking a short circuiting

CO = Making and breaking a short circuiting

t = Defined pause (3 min)

No damage to equipment or personal injury may occur in the event of short circuit. However, contactors and thermal overload relays are not required to remain functional after short circuit. It is typically the maximum short circuit breaking capacity I_{cu} in use when a plant is dimensioned according to coordination type 1.

Short circuit coordination type 2

Test demand

O-t-CO-t-CO

O = Breaking a short circuiting

CO = Making and breaking a short circuiting

t = Defined pause (3 min)

No damage to equipment or personal injury may occur in the event of short circuit. However, light contact welding is permissible, provided that contacts can be separated without deformation, using a screwdriver for example. Contactors and thermal overload relays must remain completely functional after short circuit.

It is typical the short circuit breaking capacity during operation I_{cs} in use when a plant is dimensioned according to coordination type 2.

Terms	Remarks
Prospective short circuit current (I_{cc})	The prospective short circuit current is the current that flows during a bolt short circuiting without any short circuit protection device mounted
Rated ultimate short circuit breaking capacity (I_{cu})	The ultimate short circuit breaking capacity is the maximum short circuit current specified by the manufacturer that a circuit breaker can handle under circumstances specified in IEC 947-2 and in EN 60947-2
Rated service short circuit breaking capacity (I_{cs})	The rated service short circuit breaking capacity is the maximum short circuit current specified by the manufacturer that a circuit breaker can handle under circumstances specified in IEC 947-2 and in EN 60947-2
I_r -current	The I_r -current is a short circuit test current. The size of the I_r -current is determined by the nominal current of the product. (See below)
I_q current	I_q -current is the maximum prospective short circuiting current stated by the manufacturer and often at the value 50 kA.
gL fuse	Indicates full short circuit protection at voltages 250V, 400V, 500V and 690V
gL fuse	Indicates full short circuit protection of wires.
gG fuse	Indicates full short circuit protection at general applications. (Will replace gL- and gL-fuses)
T fuse	Description of an English standard fuse.
BS 88	British Standard for smeltesikringer

Contactor size	Prospective short circuit test current
Rated current at AC-3 load	I_r in [kA]
$0 < I_e < 16$	1
$16 < I_e < 63$	3
$63 < I_e < 125$	5
$125 < I_e < 315$	10
$315 < I_e < 630$	18
$630 < I_e < 1000$	30

Circuit Breakers CTI 25M, CTI 45 MB, CTI 100

Back-up fuses type gG, gL
and $I_{cc} > I_{cu}$

Type	Setting [A]	220-240 V [A]	380-415 V [A]	440-460 V [A]	500 V [A]	690 V [A]
CTI 25M	0.1 - 0.16	-	-	-	-	-
	0.16 - 0.25	-	-	-	-	-
	0.25 - 0.4	-	-	-	-	-
	0.4 - 0.63	-	-	-	-	-
	0.63 - 1.0	-	-	-	-	-
	1.0 - 1.6	-	-	-	-	16
	1.6 - 2.5	-	-	-	-	20
	2.5 - 4.0	-	-	-	-	35
	4.0 - 6.3	-	-	-	-	50
	6.3 - 10	-	-	63	80	50
	10 - 16	-	80	63	80	63
	14.5 - 20	100	100	80	80	63
	18 - 25	100	100	80	80	63
24 - 29	125	125	100	100	80	
27 - 32	125	125	100	100	80	
CTI 45MB	32 - 45	-	125	125	125	100
CTI 100	40 - 63	-	160	160	160	160
	63 - 90	-	160	160	160	160

- = No fuse required

Circuit breaker for motor
applications

Type	Thermal setting range [A]	Magnetic Trip current [A]	Breaking capacity in kA									
			220-240 V		380-415 V		440-460 V		500 V		690 V	
			I_{cu}	I_{cs}	I_{cu}	I_{cs}	I_{cu}	I_{cs}	I_{cu}	I_{cs}	I_{cu}	I_{cs}
CTI 25M	0.1 - 0.16	2.1	100	100	100	100	100	100	100	100	100	100
	0.16 - 0.25	3.3	100	100	100	100	100	100	100	100	100	100
	0.25 - 0.40	5.2	100	100	100	100	100	100	100	100	100	100
	0.40 - 0.63	8.2	100	100	100	100	100	100	100	100	100	100
	0.63 - 1.0	13	100	100	100	100	100	100	100	100	100	100
	1.0 - 1.6	21	100	100	100	100	100	100	100	100	8	8
	1.6 - 2.5	33	100	100	100	100	100	100	100	100	8	8
	2.5 - 4.0	52	100	100	100	100	100	100	100	100	8	8
	4.0 - 6.3	82	100	100	100	100	100	100	100	100	4	4
	6.3 - 10	130	100	100	100	100	50	50	50	50	4	4
	10 - 16	208	100	100	65	50	10	6	10	6	3	3
	14.5 - 20	260	65	50	50	15	6	6	6	6	3	3
	18 - 25	325	65	50	15	15	6	6	6	6	3	3
24 - 29	406	50	25	15	15	6	6	6	6	3	3	
27 - 32	448	50	25	15	15	6	6	6	6	3	3	
CTI 45MB	32 - 45	585	100	100	65	50	50	50	50	50	10	6
CTI 100	40 - 63	882	50	50	20	8	10	6	10	6	4	4
	63 - 90	1260	50	50	20	8	10	6	10	6	4	4

Circuit Breakers CTI 25M, CTI 45 MB, CTI 100

UL/CSA specifications

Auxiliary contacts and alarm contacts CBA-, CBA S-, CBT-, CBT S-, CBI 100-, CBI 100 UI-

Type	Description	AC	DC	Max back up fuse type gG, gL
CBA-	Auxiliary contacts for front mounting	B300	Q300	0A
CBA S-	Auxiliary contacts for side mounting	B600	Q600	
CBT S-	Alarm contacts for side mounting	B600	Q600	
CBI 100-	Auxiliary contacts for front mounting	B600	R300	
CBI 100 UI-	Alarm contacts for front mounting	B600	R300	

Terminals

Type	Comments	Recommended screwdriver size	Solid wire AWG	Stranded wire AWG	Stranded wire with sleeve AWG	Tightening torque lb-in
CTI 25M	1 conductor or 2 conductors	Pozi 2/ blade 3	No. 16-8	No. 16-8	No. 16-12	8.9-22
CTI 45MB	1 conductor	Pozi 2/ blade 4	No. 14-6	No. 14-6	No. 14-8	13-31
CTI 45MB	2 conductors	Pozi 2/ blade 4	No. 14-4	No. 14-4	No. 14-6	13-31
CBA-	1 conductor or 2 conductors	Pozi 2/ blade 3	No. 14-6	No. 14-6	No. 14-8	13.3
CBA S-	1 conductor or 2 conductors	Pozi 2/ blade 3	No. 18-14	No. 18-14	No. 18-14	13.3
CBT S-	1 conductor or 2 conductors	Pozi 2/ blade 3	No. 18-14	No. 18-14	No. 18-14	13.3
VT-	1 conductor or 2 conductors	Pozi 2/ blade 3	No. 18-14	No. 18-14	No. 18-14	13.3
VTU-	1 conductor or 2 conductors	Pozi 2/ blade 3	No. 18-14	No. 18-14	No. 18-14	13.3
CBA-	1 conductor or 2 conductors	Pozi 2/ blade 3	No. 18-14	No. 18-14	No. 18-14	13.3
BBT 25	1 conductor	Pozi 2/ blade 3	No. 18-14	No. 18-14	No. 18-14	27
BBT 25	2 conductors	Pozi 2/ blade 3	No. 14-6	No. 14-6	No. 14-8	27
BBT 45	1 conductor	Pozi 2/ blade 4	No. 14-4	No. 14-4	No. 14-6	27
BBT 45	2 conductors	Pozi 2/ blade 4	No. 14-6	No. 14-6	No. 14-8	27
CTI 100	1 conductor	Allen key 5	-	No. 12-2	-	53-120
CBI 100-	2 conductors	Pozi 2/ blade 3	-	No. 18-14	-	8.8-10.3
CBI 100 UI-	2 conductors	Pozi 2/ blade 3	-	No. 18-14	-	8.8-10.3
CBI 100 UA-	2 conductors	Pozi 2/ blade 3	-	No. 18-14	-	8.8-10.3
CBI 100 AA-	2 conductors	Pozi 2/ blade 3	-	No. 18-14	-	8.8-10.3

UL/CSA specifications

Circuit breaker for overload- and short circuit protection of motor applications

Type	Range [A]	Motor rating in hp					Prospective short circuit current [kA]	
		1-phase run		3-phase run			480 V	600 V
		115 V	230 V	230 V	460 V	575 V		
CTI 25M	0.1 - 0.16	-	-	-	-	-	65	47
	0.16 - 0.25	-	-	-	-	-	65	47
	0.25 - 0.4	-	-	-	-	-	65	47
	0.4 - 0.63	-	-	-	-	-	65	47
	0.63 - 1.0	-	-	-	-	1/2	65	47
	1.0 - 1.6	-	1/10	-	3/4	3/4	65	47
	1.6 - 2.5	-	1/6	1/2	1	1½	65	30
	2.5 - 4.0	1/8	1/3	3/4	2	3	65	25
	4.0 - 6.3	1/4	1/2	1½	3	5	65	30
	6.3 - 10	1/2	1	3	5	7½	65	30
	10 - 16	3/4	2	5	10	10	30	30
	14.5 - 20	1	3	5	-	15	10	10
18 - 25	1½	-	7½	15	20	10	5	
24 - 29	-	-	10	20	25	10	-	
27 - 32	-	-	10	25	30	10	-	
CTI 45MB	32 - 45	3	7½	15	30	40	65	18
CTI 100	40 - 63	5	12	22	45	60	65	42
	63 - 90	7.2	20	30	70	85	65	30

Circuit Breakers CTI 25M, CTI 45 MB, CTI 100

Let-through curves for circuit breakers CTI 25M

Max let-through current for circuit breakers CTI 25M

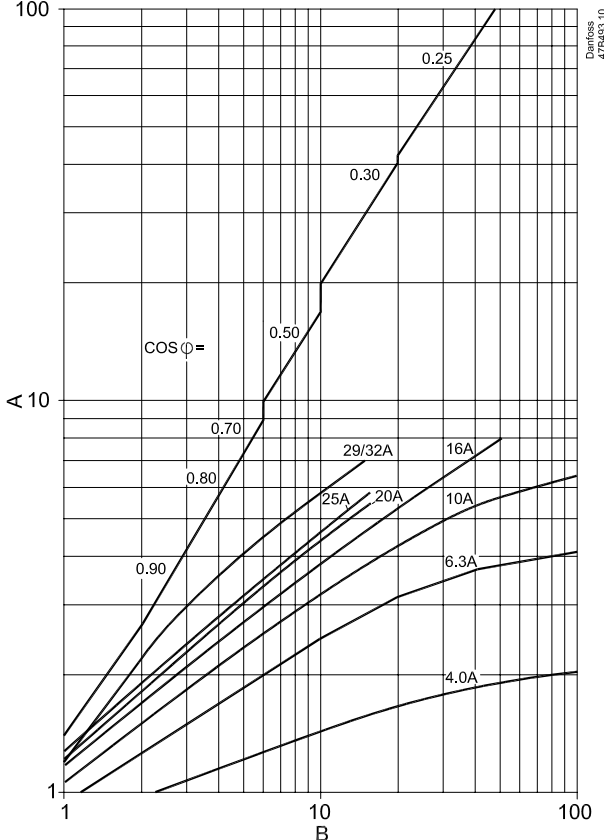

A: Max let-through current I_D [kA]
 B: The prospective short circuit current at 415 V I_{CC} [kA]

Max let-through energy for circuit breakers CTI 25M

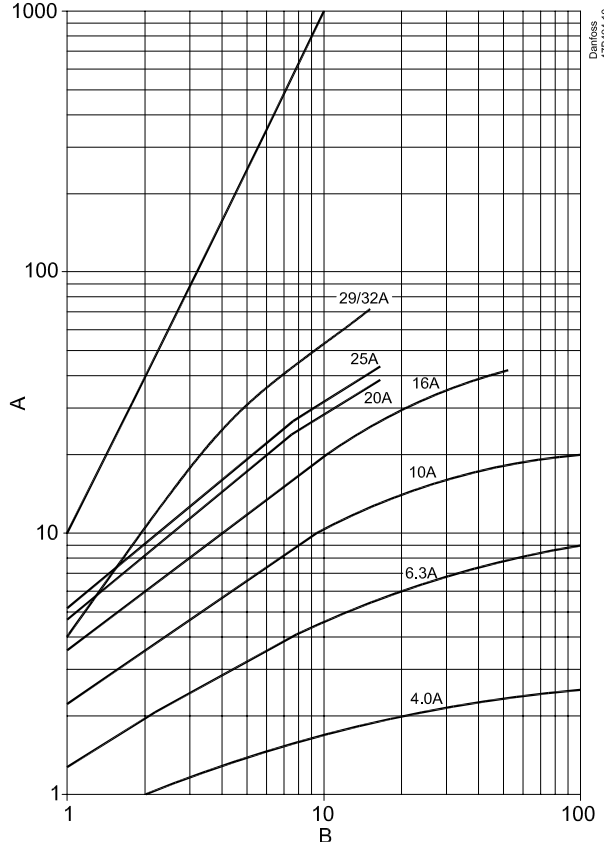

A: Max let-through energy I^2t [$kA^2 \cdot s$]
 B: The prospective short circuit current at 415 V I_{CC} [kA]

Circuit Breakers CTI 25M, CTI 45 MB, CTI 100

Let-through curves for circuit breakers CTI 45MB

Max let-through current for circuit breakers CTI 45MB

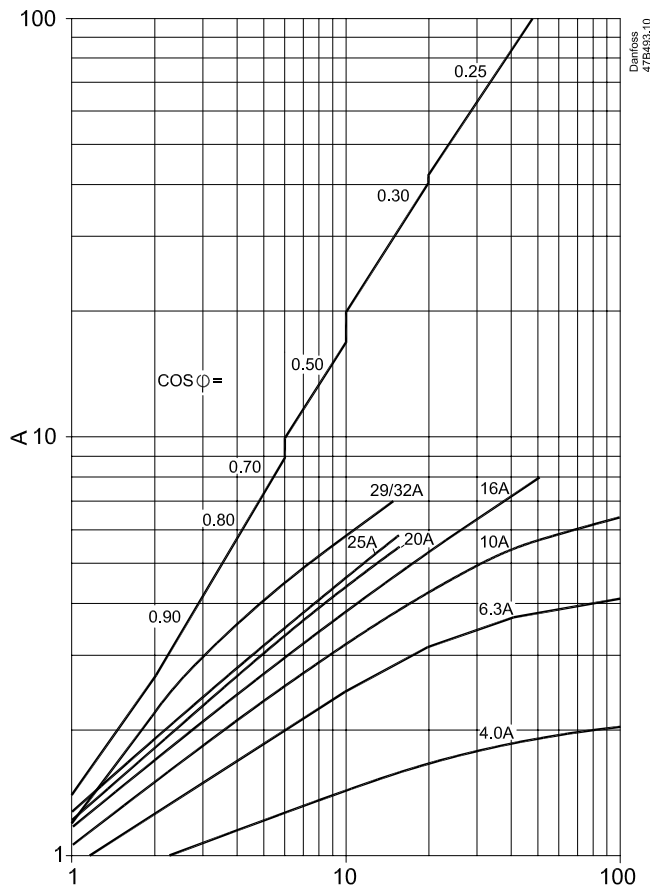

A: Max let-through current I_D [kA]
 B: The prospective short circuit current at 415 V I_{CC} [kA]

Max let-through energy for circuit breakers CTI 45MB

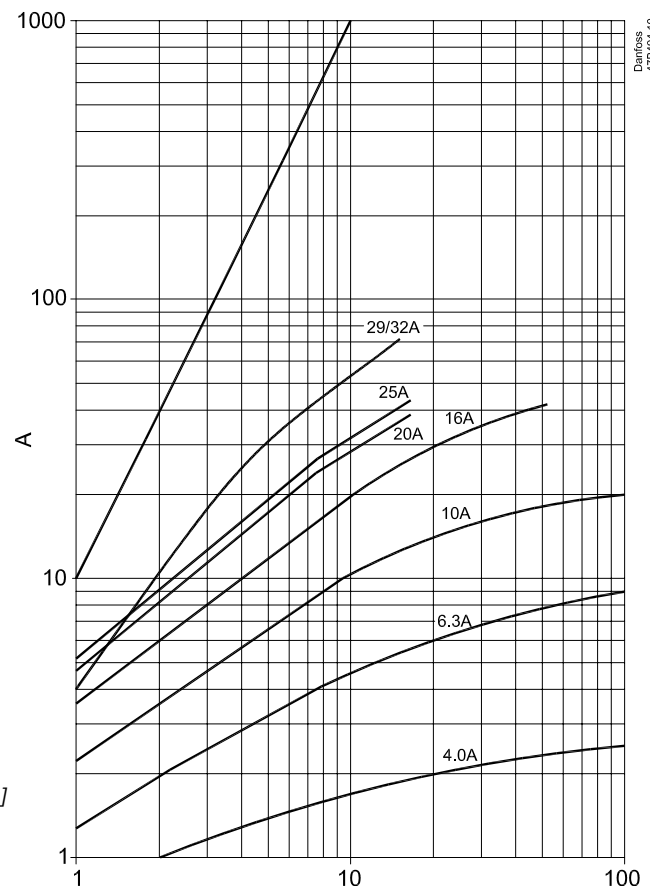

A: Max let-through energy I^2t [kA²s]
 B: The prospective short circuit current at 415 V I_{CC} [kA]

Circuit Breakers CTI 25M, CTI 45 MB, CTI 100

Let-through curves for circuit breakers CTI 100

Max let-through current for circuit breaker CTI 100

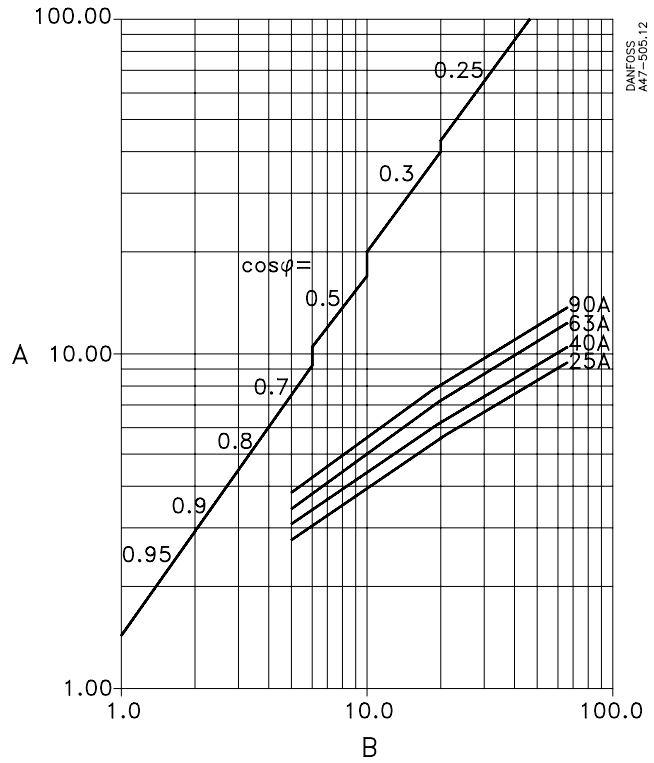

A: Max let-through current I_D [kA]
B: The prospective short circuit current at 415 V I_{CC} [kA]

Max let-through energy for circuit breaker CTI 100

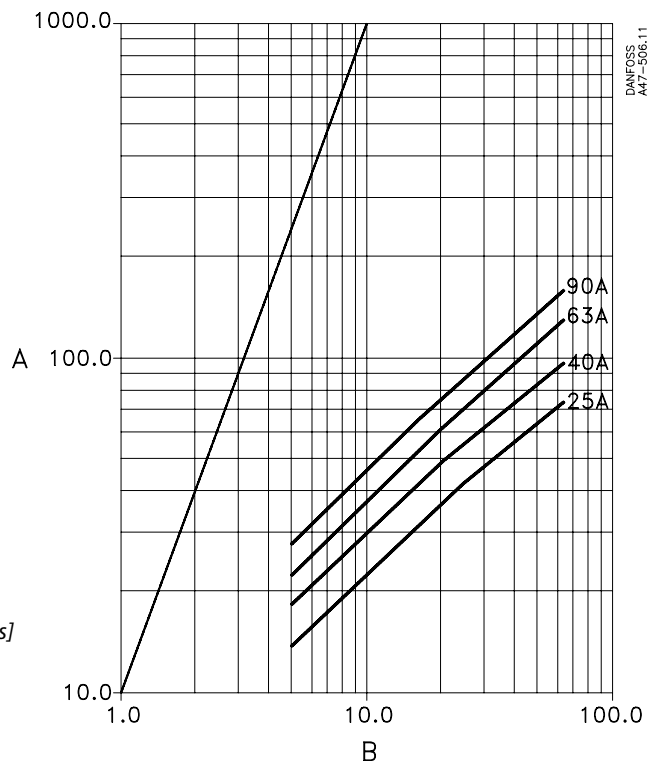

A: Max let-through current I^2t [kA²s]
B: The prospective short circuit current at 415 V I_{CC} [kA]

Circuit Breakers CTI 25M, CTI 45 MB, CTI 100

Overload protection of motors

Tripping characteristic for CTI 25M

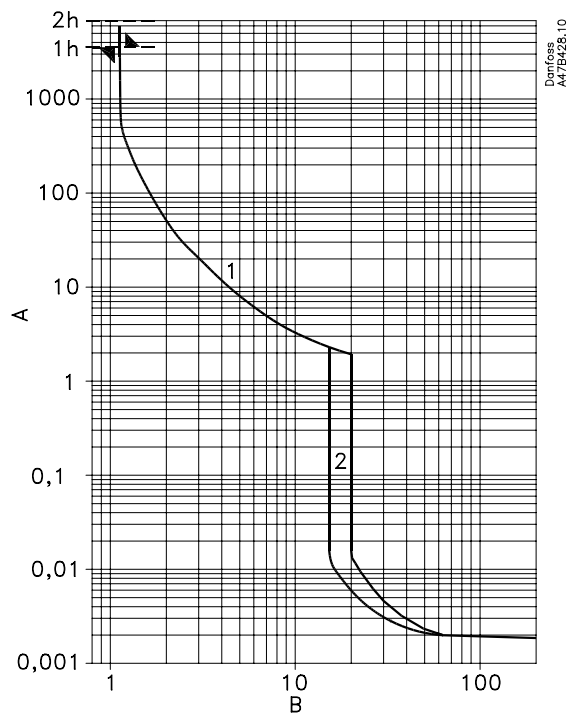

A: Trip time in sec.
B: Times the adjustable current I_{ef}

1) Thermal trip

The adjustable bimetals ensure a reliable overload protection of motors. The curve is mean value curve at 20°C ambient temperature from cold state. It also ensures protection of motors by phase failure (differential trip).

All three bimetals must be connected in series by overload protection of 1-phase motors.

2) Magnetic trip

The electromagnetic trips react at a fixed response current. The size of the fixed response current correspond typically to 13 times of the maximum range of the circuit breakers CTI 25M, CTI 45MB.

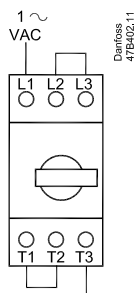

Circuit Breakers CTI 25M, CTI 45 MB, CTI 100

Overload protection of motors

Tripping characteristic for CTI 100

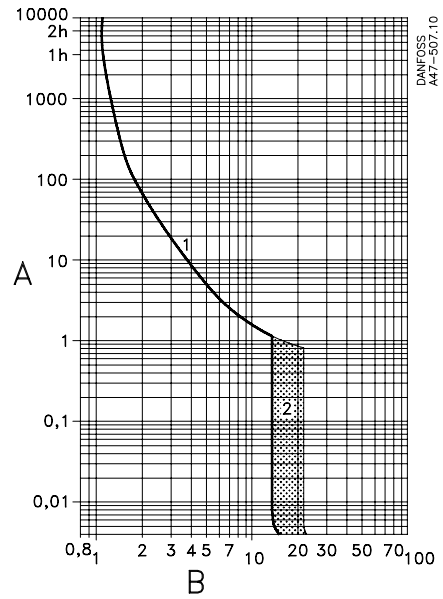

A: Trip times in sec.
B: Times the adjustable current I_a

1) Thermal trip

The adjustable bimetals ensure a reliable overload protection of motors. The curve is mean value curve at 20°C ambient temperature from cold state. It also ensures protection of motors by phase failure (differential trip).

All three bimetals must be connected in series by overload protection of 1-phase motors.

2) Magnetic trip

The electromagnetic trips react at a fixed response current. The size of the fixed response current correspond typically to 13 times of the maximum range of the circuit breakers CTI 25M, CTI 25MB, CTI 45MB.

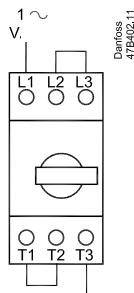

Circuit Breakers CTI 25M, CTI 45 MB, CTI 100

Coordination without fuse

Circuit breakers and contactors

Max. prospective short circuit-current $I_q = 50 \text{ kA}$
 Voltage 380-415 V/50 Hz
 Overload protection CTI 25M-MB, CTI 45MB, CTI 100
 Short-circuit protection CTI 25M-MB, CTI 45MB, CTI 100
 Short-circuit coordination T1 and T2

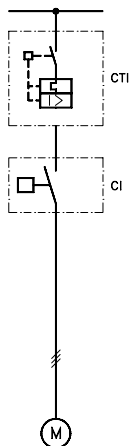

Contactor	Coordination type 1		Coordination type 2	
	$I_r^{1)}$ and $I_q = 50 \text{ kA}$			
	CTI 25M	CTI 45MB CTI 100	CTI 25 M	CTI 45MB CTI 100
	Max. CTI range (A)			
CI 5-2, CI 5, CI 5-9, CI 5-12	25	45	2.5	2.5
CI 6, CI 9	25	45	2.5	2.5
CI 12, CI 15	25	45	4.0	4.0
CI 16	25	45	6.3	20
CI 20, CI 25	25	45	6.3	25
CI 30	25	45	10	25
CI 32	-	45	-	32
CI 37, CI 45, CI 50	-	90	-	45
CI 61, CI 73, CI 86	-	-	-	90

¹⁾ Short-circuit current according to EN 60947-4 (see page 16)

Circuit breakers, contactors and thermal overload relays

Max. prospective short-circuit current $I_q = 50 \text{ kA}$
 Voltage 380-415 V/50 Hz
 Overload protection Thermal overload relay type T1 9C, T1 16C, T1 25C, T1 30C, T1 80
 Short-circuit protection CTI 25M-MB, CTI 45MB, CTI 100
 Short-circuit coordination T1

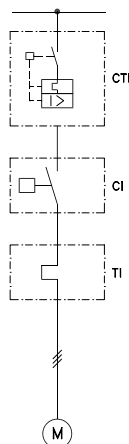

Contactor	Thermal overload relay range [A]	Coordination type T1 Test current $I_r^{1)}$ and $I_q = 50 \text{ kA}$ Max. CTI range [A]
CI 5-9, CI 6, CI 9	0.13 - 0.20	45 A
CI 5-9, CI 6, CI 9	0.19 - 0.29	
CI 5-9, CI 6, CI 9	0.27 - 0.42	
CI 5-9, CI 6, CI 9	0.4 - 0.62	
CI 5-9, CI 6, CI 9	0.6 - 0.92	
CI 5-9, CI 6, CI 9	0.85 - 1.3	
CI 5-9, CI 6, CI 9	1.2 - 1.9	63 A
CI 5-9, CI 6, CI 9	1.8 - 2.8	
CI 5-9, CI 6, CI 9	2.7 - 4.2	
CI 5-9, CI 6, CI 9	4 - 6.2	
CI 9	6 - 9.2	
CI 12, CI 15	8 - 12	
CI 15, CI 16	11 - 16	90 A
CI 16, CI 20	15 - 20	
CI 25	19 - 25	
CI 30	24 - 32	
CI 32	22 - 32	
CI 37, CI 45	30 - 45	
CI 50, CI 61	42 - 63	
CI 73	60 - 80	
CI 86	74 - 85	

¹⁾ Short-circuit current according to EN 60947-4 (see page 16)

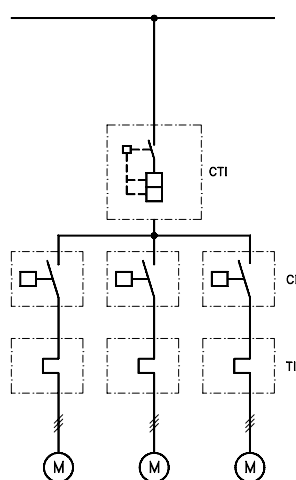

Circuit Breakers CTI 25M, CTI 45 MB, CTI 100

Coordination with fuse

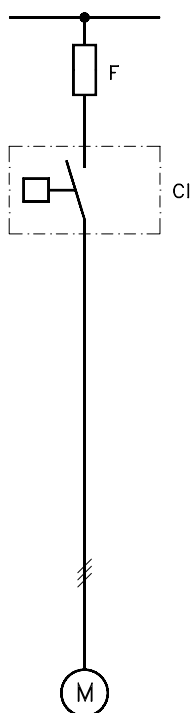

Contactors

Max. prospective short-circuit current
Voltage
Overload/short-circuit protection
Short-circuit coordination

$I_q = 50$ kA
380-415 V/50 Hz
gG and T (BS88)
T1 and T2

Contactor	Short-circuit coordination					
	T1		T2			
	Test current					
	$I_r^{1)}$ and $I_Q = 50$ kA		$I_r^{1)}$ and $I_Q = 10$ kA		$I_r^{1)}$ and $I_Q = 50$ kA	
gG [A]	T [A]	gG [A]	T [A]	gG [A]	T [A]	
CI 5-2, CI 5-9, CI 5-12	25	32	16	20	16	20
CI 6, CI 9, CI 12, CI 15	50	63	25	32	25	32
CI 16	80	80	25	32	25	32
CI 20, CI 25	80	08	25	32	25	32
CI 30	80	80	35	40	25	32
CI 32	125	125	50	63	35	40
CI 37, CI 45, CI 50	125	125	80	80	80	80
CI 61, CI 73, CI 86	250	-	-	-	160	-
CI 110	250	-	-	-	200	-
CI 141	315	-	-	-	250	-
CC 180 EI	355	-	-	-	315	-
CI 210 EI, CI 250 EI	500	-	-	-	400	-

¹⁾ Short-circuit current according to EN 60947-4 (see page 16)

Contactors and thermal overload relays

Max. prospective short-circuit current
Voltage
Overload/short-circuit protection
Short-circuit coordination

$I_q = 50$ kA
380-415 V/50 Hz
gG and T (BS88)
T1 and T2

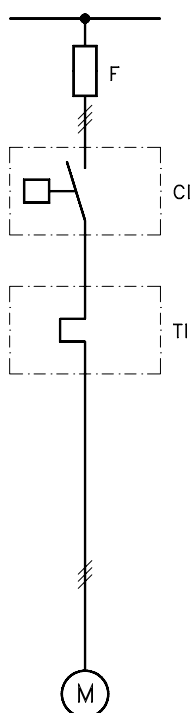

Contactor	Thermal overload relay A	Short-circuit coordination					
		T1		T2			
		Test current					
		$I_r^{1)}$ and $I_Q = 50$ kA		$I_r^{1)}$ and $I_Q = 10$ kA		$I_r^{1)}$ and $I_Q = 50$ kA	
gG [A]	T [A]	gG [A]	T [A]	gG [A]	T [A]		
CI 5-9, CI 6, CI 9	0.13 - 0.20	25	32	2	2	-	-
CI 5-9, CI 6, CI 9	0.19 - 0.29	25	32	2	2	-	2
CI 5-9, CI 6, CI 9	0.27 - 0.42	25	32	2	2	2	2
CI 5-9, CI 6, CI 9	0.4 - 0.62	25	32	4	4	4	4
CI 5-9, CI 6, CI 9	0.6 - 0.92	25	32	4	6	4	6
CI 5-9, CI 6, CI 9	0.85 - 1.3	25	32	4	6	4	6
CI 5-9, CI 6, CI 9	1.2 - 1.9	25	32	6	10	6	10
CI 5-9, CI 6, CI 9	1.8 - 2.8	25	32	6	10	6	10
CI 5-9, CI 6, CI 9	2.7 - 4.2	25	32	16	20	16	20
CI 5-9, CI 6, CI 9	4 - 6.2	35	40	20	25	20	25
CI 5-9, CI 6, CI 9	6 - 9.2	50	50	20	25	20	25
CI 12	8 - 12	63	63	25	32	25	32
CI 15, CI 16	11 - 16	80	80	25	32	25	32
CI 20, CI 25	15 - 20	80	80	35	40	35	40
CI 25	19 - 25	80	80	35	40	35	40
CI 30	24 - 32	80	80	35	40	35	40
CI 32	16 - 23	125	125	50	63	35	40
CI 32	22 - 32	125	125	63	63	35	40
CI 37, CI 45	30 - 45	125	125	80	80	63	63
CI 50	42 - 63	125	125	80	80	63	63
CI 61	42 - 63	160	-	-	-	80	-
CI 73	60 - 80	160	-	-	-	125	-
CI 86	74 - 85	160	-	-	-	160	-
CI 98	20 - 180	250	-	-	-	200	-
CI 141	20 - 180	315	-	-	-	250	-
CI 180 EI	20 - 180	355	-	-	-	315	-
CI 210 EI, CI 250 EI	160 - 630	500	-	-	-	400	-
CI 300 EI, CI 420	160 - 630	630	-	-	-	500	-

¹⁾ Short-circuit current according to EN 60947-4 (see page 16)

Circuit Breakers CTI 25M, CTI 45 MB, CTI 100

Dimensions

Circuit breakers CTI 25M

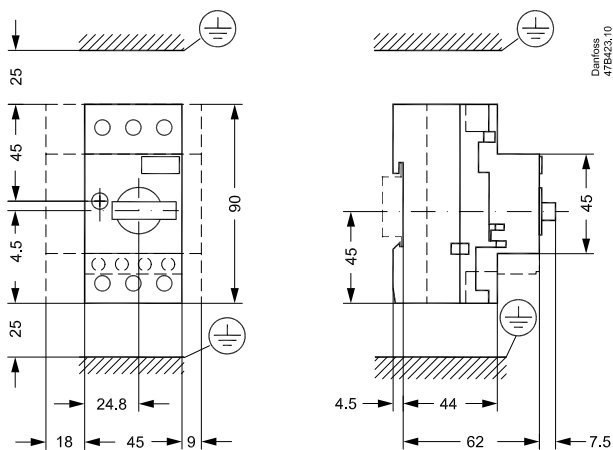

Circuit breakers CTI 45MB

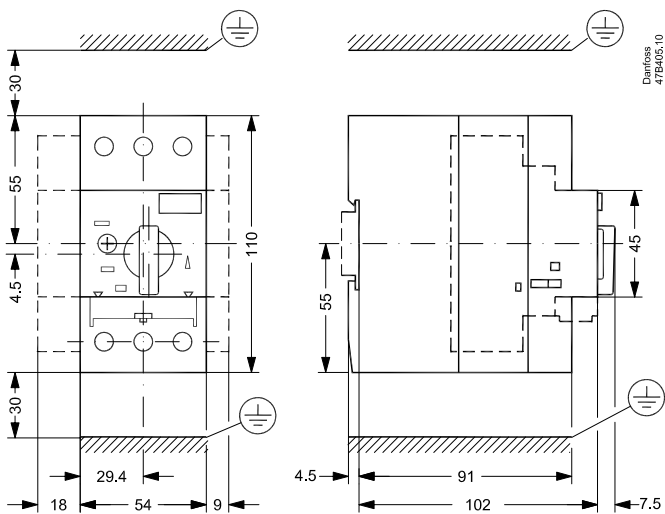

Circuit Breakers CTI 25M, CTI 45 MB, CTI 100

Dimensions

Circuit breakers CTI 100

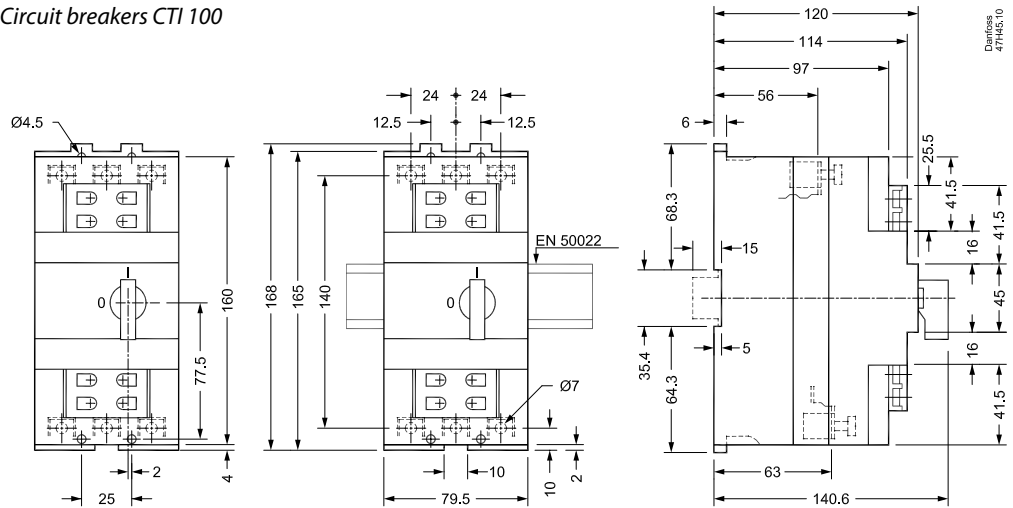

Enclosures BMG and BMY for circuit breakers CTI 25M

