



INSTRUCTIONS



084R8032

REFRIGERATION AND
AIR CONDITIONING

AK-CC 250A



RI8PG302

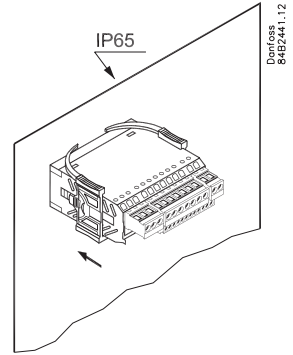
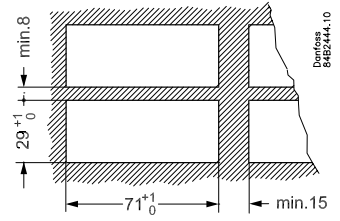
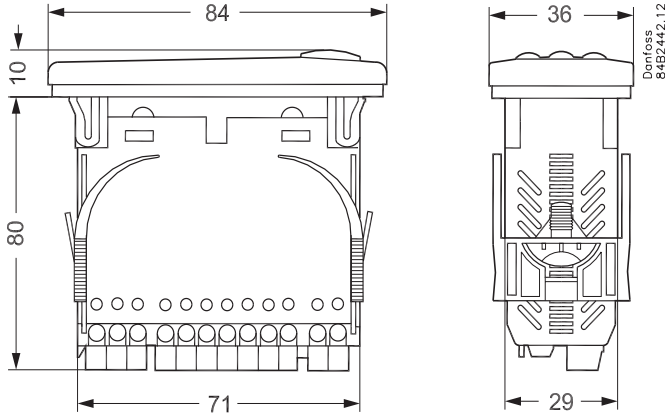

$t_{amb} = 0 - +55^{\circ}\text{C}$

230 V a.c. 50/60 Hz

2.5 VA

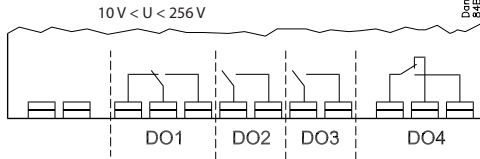

	CE (250 V a.c.)	UL *** (240 V a.c.)
DO1. Refrigeration *	8 (6) A	10 A Resistive 5FLA, 30LRA
DO2. Defrost *	8 (6) A	10 A Resistive 5FLA, 30LRA
DO3. Fan or refrigeration 2 *	6 (3) A	6 A Resistive 3FLA, 18LRA 131 VA Pilot duty
DO4. Alarm, light, rail heat or hotgas defrost *	4 (1) A Min. 100 mA**	4 A Resistive 131 VA Pilot duty

* DO1 and DO2 are 16 A relays. DO3 and DO4 are 8 A relays. Max. load must be kept.
** Gold plating ensures make function with small contact loads
*** UL-approval based on 30000 couplings

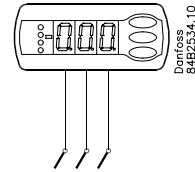

Pt / PTC sensors

See page 6.

Coordinated defrost

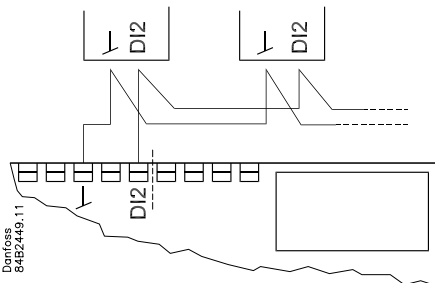

Data communication MOD-BUS:

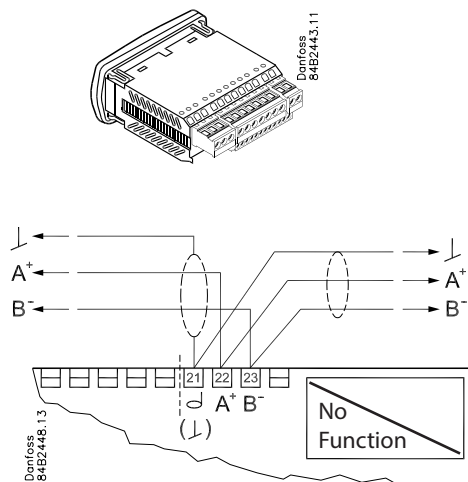

o61 — Electrical connections

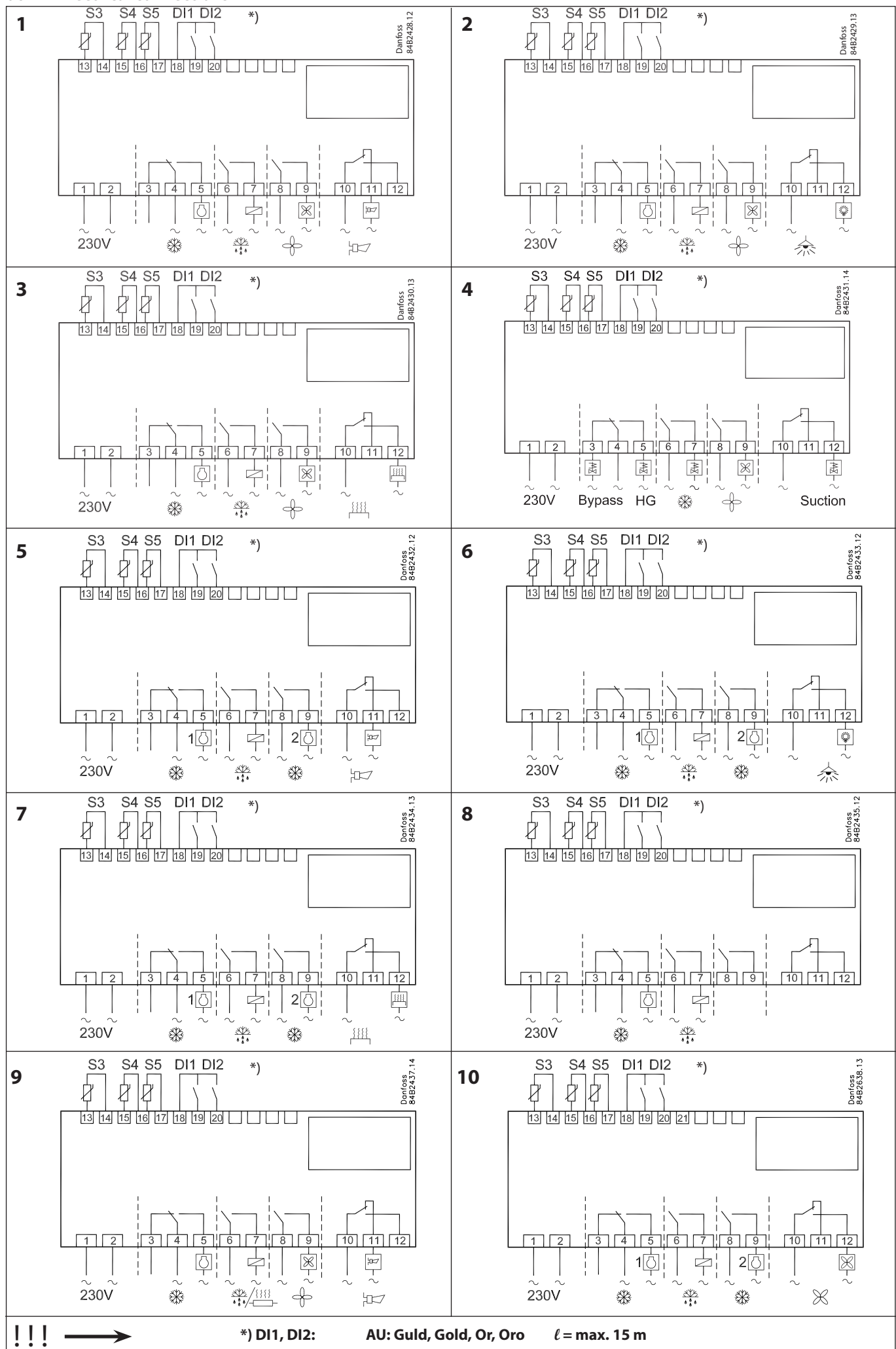

Setting:

- 1 Open parameter r12 and stop the regulation
- 2 Open parameter o06 and set the used sensor type
- 3 Select electric connection based on the drawings on page 2
- 4 Open parameter o61 and set the electric connection number in it
- 5 Now select one of the preset settings from the table on the right-hand side
- 6 Open parameter o62 and set the number for the array of presets
- 7 Open parameter r12 and start the regulation
- 8 Go through the survey of factory settings. Make any necessary changes in the respective parameters.
- 9 For network.
 - a. Set the address in o03
 - b. Start scan function in the system unit.

Auxiliary table for settings (quick-setup)	Case			Room		
	Defrost stop on time	Defrost stop on S5		Defrost stop on time	Defrost stop on S5	
Preset settings (o62)	1	2	3	4	5	6
Temperature (SP)	4°C	2°C	-24°C	6°C	3°C	-22°C
Max. temp. setting (r02)	6°C	4°C	-22°C	8°C	5°C	-20°C
Min. temp. setting (r03)	2°C	0°C	-26°C	4°C	1°C	-24°C
Sensor signal for thermostat. S4% (r15)	100%			0%		
Alarm limit high (A13)	10°C	8°C	-15°C	10°C	8°C	-15°C
Alarm limit low (A14)	-5°C	-5°C	-30°C	0°C	0°C	-30°C
Sensor signal for alarm funct.S4% (A36)	100%			0%		
Interval between defrost (d03)	6 h	6h	12h	8h	8h	12h
Defrost sensor: 0=time, 1=S5, 2=S4 (d10)	0	1	1	0	1	1
DI1 config. (o02)	Case cleaning =10			Door function =3		
Sensor signal for display view S4% (O17)	100%			0%		

Array 1-6: The settings in the grey fields will be changed

Function	Parameters		EL-diagram number (page 2)										Min.-value	Max.-value	Factory setting	Actual setting
	Codes		1	2	3	4	5	6	7	8	9	10				
Normal operation																
Temperature (set point)		---											-50.0°C	50.0°C	2.0°C	
Thermostat																
Differential	***	r01											0.0 K	20.0K	2.0 K	
Max. limitation of stepson setting	***	r02											-49.0°C	50°C	50.0°C	
Min. limitation of set point setting	***	r03											-50.0°C	49.0°C	-50.0°C	
Adjustment of temperature indication		r04											-20.0 K	20.0 K	0.0 K	
Temperature unit (°C/°F)		r05											°C	°F	°C	
Correction of the signal from S4		r09											-10.0 K	+10.0 K	0.0 K	
Correction of the signal from S3		r10											-10.0 K	+10.0 K	0.0 K	
Manual service, stop regulation, start regulation (-1, 0, 1)		r12											-1	1	0	
Displacement of reference during night operation		r13											-10.0 K	10.0 K	0.0 K	
Definition and weighting, if applicable, of thermostat sensors - S4% (100%=S4, 0%=S3)		r15											0%	100%	100%	
The heating function is started a number of degrees below the thermostats cutout temperature		r36											-15.0 K	-3.0 K	-15.0 K	
Activation of reference displacement r40		r39											OFF	ON	OFF	
Value of reference displacement (activate via r39 or DI)		r40											-50.0 K	50.0 K	0.0 K	
Alarm																
Delay for temperature alarm		A03											0 min	240 min	30 min	
Delay for door alarm	***	A04											0 min	240 min	60 min	
Delay for temperature alarm after defrost		A12											0 min	240 min	90 min	
High alarm limit	***	A13											-50.0°C	50.0°C	8.0°C	
Low alarm limit	***	A14											-50.0°C	50.0°C	-30.0°C	
Alarm delay DI1		A27											0 min	240 min	30 min	
Alarm delay DI2		A28											0 min	240 min	30 min	
Signal for alarm thermostat. S4% (100%=S4, 0%=S3)		A36											0%	100%	100%	
Compressor																
Min. ON-time		c01											0 min	30 min	0 min	
Min. OFF-time		c02											0 min	30 min	0 min	
Time delay for cutin of comp.2		c05											0 sec	999 sec	0 sec	
Compressor relay 1 must cutin and out inversely (NC-function)		c30											0	1	0	
													OFF	ON	OFF	
Defrost																
Defrost method (none/EL/GAS/BRINE)		d01											no	bri	EL	
Defrost stop temperature		d02											0.0°C	25.0°C	6.0°C	
Interval between defrost starts		d03											0 hours	48 hours	8 hours	
Max. defrost duration		d04											0 min	180 min	45 min	
Displacement of time on cutin of defrost at start-up		d05											0 min	240 min	0 min	
Drip off time		d06											0 min	60 min	0 min	
Delay for fan start after defrost		d07											0 min	60 min	0 min	
Fan start temperature		d08											-15.0°C	0.0°C	-5.0°C	
Fan cutin during defrost		d09											0	2	1	
0: Stopped 1: Running 2: Running during pump down and defrost																
Defrost sensor (0=time, 1=S5, 2=S4)		d10											0	2	0	
Pump down delay		d16											0 min	60 min	0 min	
Drain delay		d17											0 min	60 min	0 min	
Max. aggregate refrigeration time between two defrosts		d18											0 hours	48 hours	0 hours	
Defrost on demand - S5 temperature's permitted variation during frost build-up. On central plant choose 20 K (=off)		d19											0.0 K	20.0 k	20.0 K	
Delay of hot gas injection		d23											0 min	60 min	0 min	

			1	2	3	4	5	6	7	8	9	10			
Fan															
Fan stop at cutout compressor	F01												no	yes	no
Delay of fan stop	F02												0 min	30 min	0 min
Fan stop temperature (S5)	F04												-50.0°C	50.0°C	50.0°C
HACCP															
Actual temperature measurement for the HACCP function	h01														
Last registered peak temperature	h10														
Selection of function and sensor for the HACCP function. 0 = no HACCP function. 1 = S4 used (maybe also S3). 2 = S5 used	h11												0	2	0
Alarm limit for the HACCP function	h12												-50.0°C	50.0°C	8.0°C
Time delay for the HACCP alarm	h13												0 min.	240 min.	30 min.
Select signal for the HACCP function. S4% (100% = S4, 0% = S3)	h14												0%	100%	100%
Real time clock															
Six start times for defrost. Setting of hours. 0=OFF	t01-t06												0 hours	23 hours	0 hours
Six start times for defrost. Setting of minutes. 0=OFF	t11-t16												0 min	59 min	0 min
Clock - Setting of hours	*** t07												0 hours	23 hours	0 hours
Clock - Setting of minute	*** t08												0 min	59 min	0 min
Clock - Setting of date	*** t45												1	31	1
Clock - Setting of month	*** t46												1	12	1
Clock - Setting of year	*** t47												0	99	0
Miscellaneous															
Delay of output signals after start-up	o01												0 s	600 s	5 s
Input signal on DI1. Function: 0=not used. 1=status on DI1. 2=door function with alarm when open. 3=door alarm when open. 4=defrost start (pulse-pressure). 5=ext.main switch. 6=night operation 7=change reference (activate r40). 8=alarm function when closed. 9=alarm function when open. 10=case cleaning (pulse pressure). 11=forced cooling at hot gas defrost.	o02												1	11	0
Network address (0=off)	o03												0	240	0
Access code 1 (all settings)	o05												0	100	0
Used sensor type. See page 6. Pt: Pt 1000 Ω @ 0°C P01: PTC 1000 Ω (nominal 990 Ω) = EKS 111 P02: PTC 1000 Ω @ 25°C (nominal 1000 Ω)	o06												Pt	P02	Pt
Display step = 0.5 (normal 0.1 at Pt sensor)	o15												no	yes	no
Max hold time after coordinated defrost	o16												0 min	60 min	20
Select signal for display view. S4% (100%=S4, 0%=S3)	o17												0%	100%	100%
Input signal on DI2. Function: (0=not used. 1=status on DI2. 2=door function with alarm when open. 3=door alarm when open. 4=defrost start (pulse-pressure). 5=ext. main switch 6=night operation 7=change reference (activate r40). 8=alarm function when closed. 9=alarm function when open. 10=case cleaning (pulse pressure). 11=forced cooling at hot gas defrost.). 12=coordinated defrost)	o37												0	12	0
Configuration of light function (relay 4) 1=ON during day operation. 2=ON / OFF via data communication. 3=ON follows the DI-function, when DI is selected to door function or to door alarm	o38												1	3	1
Activation of light relay (only if o38=2)	o39												OFF	ON	OFF
Rail heat On time during day operations	o41												0%	100%	0
Rail heat On time during night operations	o42												0%	100%	0
Rail heat period time (On time + Off time)	o43												6 min	60 min	10 min
Case cleaning. 0=no case cleaning. 1=Fans only. 2=All output Off.	*** o46												0	2	0
Selection of EL diagram. See overview page 2	* o61*												1	10	1
Download a set of predetermined settings. See overview previous page.	* o62*												0	6	0
Access code 2 (partly access)	*** o64												0	100	0
Save the controllers present settings to the programming key. Select your own number.	o65												0	25	0
Load a set of settings from the programming key (previously saved via o65 function)	o66*												0	25	0
Replace the controllers factory settings with the present settings	o67												OFF	On	OFF
Service															
Status codes are shown on page 5	S0-S33														
Temperature measured with S5 sensor	*** u09														
Status on DI1 input. on/1=closed	u10														
Temperature measured with S3 sensor	*** u12														
Status on night operation (on or off) 1=closed	*** u13														
Temperature measured with S4 sensor	*** u16														
Thermostat temperature	u17														
Read the present regulation reference	u28														
Status on DI2 output. on/1=closed	u37														
Temperature shown on display	u56														
Measured temperature for alarm thermostat	u57														
Status on relay for cooling	** u58														
Status on relay for fan	** u59														

Status on relay for defrost	**	u60																											
Status on relay for rail heat	**	u61																											
Status on relay for alarm	**	u62																											
Status on relay for light	**	u63																											
Status on relay for valve in suction line	**	u64																											
Status on relay for compressor 2	**	u67																											

*) Can only be set when regulation is stopped (r12=0)

SW = 2.3x

***) Can be controlled manually, but only when r12=-1

****) With access code 2 the access to these menus will be limited

Factory settings are indicated for standard units. Other code numbers have customized settings.

Fault code display		Alarm code display		Status code display	
E 1	Fault in controller	A 1	High temperature alarm	S 0	Regulating
E 6	Change battery + check clock	A 2	Low temperature alarm	S 1	Waiting for end of the coordinated defrost
E 25	S3 sensor error	A 4	Door alarm	S 2	ON-time Compressor
E 26	S4 sensor error	A 5	Max. Hold time	S 3	OFF-time Compressor
E 27	S5 sensor error	A 15	DI 1 alarm	S 4	Drip-off time
		A 16	DI 2 alarm	S 10	Refrigeration stopped by main switch
		A 45	Standby mode	S 11	Refrigeration stopped by thermostat
		A 59	Case cleaning	S 14	Defrost sequence. Defrosting
		A 60	HACCP alarm	S 15	Defrost sequence. Fan delay
				S 17	Door open (open DI input)
				S 20	Emergency cooling
				S 25	Manual control of outputs
				S 29	Case cleaning
				S 30	Forced cooling
				S 32	Delay of output at start-up
				S33	Heat function r36 is active
				non	The defrost temperature cannot be displayed. There is stop based on time
				-d-	Defrost in progress
				PS	Password required

The buttons

Set menu

1. Push the upper button until a parameter r01 is shown
2. Push the upper or the lower button and find that parameter you want to change
3. Push the middle button until the parameter value is shown
4. Push the upper or the lower button and select the new value
5. Push the middle button again to enter the value.

Cutout alarm relay / receipt alarm/see alarm code

- Push short the upper button

Set temperature

1. Push the middle button until the temperature value is shown
2. Push the upper or the lower button and select the new value
3. Push the middle button to select the setting.

Reading the temperature at defrost sensor

- Push briefly the lower button

Manuel start or stop of a defrost

- Push the lower button for four seconds. (Though not for application 4).

See HACCP registration

1. Give the middle button a long push until h01 appears
2. Select required h01-h10
3. See value by giving the middle button a short push

LED

Light emitting diode



= refrigeration



= defrost



= fan running

Flashes fast at alarm

HACCP

HACCP function is active

Sensor overview

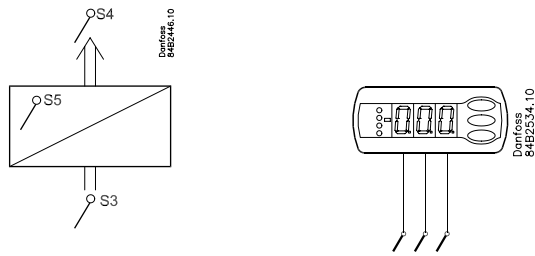

o06
 Pt: Pt 1000 Ω @ 0°C (AKS 11, AKS 12, AKS 21)
 P01: PTC 1000 Ω (nominal 990 Ω) = EKS 111
 P02: PTC 1000 Ω @ 25°C (nominal 1000 Ω)

	Pt 1000 @ 0°C	PTC 1000 Ω	PTC 1000 Ω @ 25°C
	AKS 11, AKS 12, AKS 21	KTY81-121 EKS 111	KTY81-110
°C	Ω	Ω	Ω
30	1167.7	1029	1040
25	1097.3	990	1000
20	1077.9	951	961
15	1058.5	914	923
10	1039.0	877	886
5	1019.5	841	850
0	1000.0	807	815
-5	980.4	773	781
-10	960.9	740	747
-15	941.2	708	715
-20	921.6	677	684
-25	901.9	647	653
-30	882.2	617	624
-35	862.5	589	595
-40	842.7	562	567
	Carel: TSH/TST/TSM/ TSQ/PT1 Dixell: PMG/PMP/PMT	Carel: 03/06/015 Dixell: S6 Elliwell: SN6/SN7 Lae: ST1K.CP	Frigo: VX6
o06	Pt	P01	P02

AK-CC 250A

Additional information:	English Manual	RS8GC...	www.danfoss.com
Weitere Information:	Deutsches Manual		
Renseignements supplémentaires:	Manuel en français		
Yderligere information:	Dansk Manual		
Información adicional:	Manual español		
Ytterligare information:	Svenska Handbok		
Aanvullende informatie:	Dutch Handleiding		