

ENGINEERING
TOMORROW

Danfoss

User Guide

OPTYMA™ Control Three-phase AK-RC 103



Table of contents	Page
General	3
Description	3
Functions and main characteristics	3
Applications	3
Technical characteristics of OPTYMA™ Control three-phase	4
Connection diagrams	5
Overall dimensions	5
Identification data	6
Transport and storage	6
Installation	6
Standard assembly kit	6
Mechanical assembly.....	6
Installing the unit	7
Electrical wiring.....	10
Front panel connection.....	11
Checks before use	12
Calibrating of motor protector for the compressor motor	13
Closing the control	14
Control panel	15
Front keypad	15
LED display	16
General.....	16
Symbols used.....	16
Setting and displaying the setpoints	16
Level 1 - Programming (User Level)	17
List of Level 1 variables (User Level)	17
Level 2 - Programming (Installer Level)	18
List of Level 2 variables (Installer Level)	18
Switching on the OPTYMA™ Control three-phase.....	19
Compressor activation/deactivation conditions	19
Manual defrosting.....	19
Pump-down function	20
Password function	20
Alarm/AUX RELAY SWITCHING / Data communication	21
Alarm codes	23
Trouble shooting	24
General safety instructions	25
Maintenance	25
Parts list	26
Ordering	27

General

Description

The OPTYMA™ Control three-phase is a controller for refrigeration systems with a three-phase compressor or for controlling the three-phase evaporating unit only, for complete cold room management. Front access to the automatic fuse and motor protector for the compressor and an innovative design combine to make it the ideal choice for effective refrigeration control.

Applications

- Complete management of three-phase refrigerating systems up to 7.5 HP static or ventilated, with off-cycle or electrical defrosting.

Functions and main characteristics

- LED icons to signal plant status.
- Electronic control with wide LED display and easy to use buttons.
- Display and adjustment of cold room temperature accurate to 0.1 °C.
- Display of evaporator temperature from parameter.
- System control activation/deactivation.
- Alarm signalling: sensor errors, minimum and maximum temperature alarm, compressor protection (man-in-cold-room alarm in preset models).
- Evaporator fan control.
- Automatic and manual defrost control (static, heating element).
- Direct or pump-down control of motor compressor unit (selectable by terminal block connection in preset models).
- Room light activation, via panel key or door switch
- Auxiliary relay with activation configurable by parameter.
- Parameter access with password (4 different selectable restriction levels).
- General automatic fuse accessible from the front panel, which cuts the general power supply.
- Adjustable motor protector for compressor protection accessible from the front panel (in preset models).
- Modbus data communication that can be connected to an ADAP-KOOL® system unit.
- If data communication is used, it is important that the data communication cable is correctly installed. See separate literature, no. RC8AC...
- If data communication is used, the alarm relay cannot be used.
- Defrosting, lights and alarms can be operated via data communication.

Technical characteristics of OPTYMA™ Control three-phase

Technical characteristics	OPTYMA™ Control (4 HP)	OPTYMA™ Control (7.5 HP)
Housing dimensions	400 x 300 x 135 mm	400 x 300 x 135 mm
Weight	9 kg	10 kg
Protection rating	IP 65	IP 65
Power supply (3F+N+T)	400Vac ±10% 50/60Hz	400Vac ±10% 50/60Hz
Load type	3-phase	3-phase
Operating temperature	- 5 to + 40 °C	- 5 to + 40 °C
Storage temperature	-25 to +55 °C	-25 to +55 °C
Relative ambient humidity	from 30% to 95% RH none condensate	from 30% to 95% RH none condensate
Altitude	< 1000 m	< 1000 m
Main switch / general protection Interruption power	4-pole automatic fuse 16A "D" Icn=6kA / Ics=8kA / Icu=15kA	4-pole automatic fuse 25A "D" Icn=6kA / Ics=8kA / Icu=15kA
Compressor protection	Adjustable motor protector	Adjustable motor protector
Defrosting	electrical	electrical
Status indicators	LED + display	LED + display
Alarm signals	LED + buzzer	LED + buzzer

Inputs

Room sensor	EKS 221	EKS 221
Evaporator sensor	EKS 221	EKS 221
Door switch	present	present
High/low pressure switch	present	present
Kriwan® connection	present	present
Compressor functioning mode selection	pump-down / thermostat	pump-down / thermostat
Digital inputs (requirements to contacts)	Gold plating	Gold plating

Outputs

Compressor	See motor protector thermal range	See motor protector thermal range
Condenser fans output 1	800W (1 phase)	800W total
Condenser fans output 2 (separated)		
Evaporator fans	500W (1 phase)	2000W (1phase / 3 phases)
Defrosting heating element	6000W (AC1) eq. resistive load	9000W (AC1) eq. resistive load
Room light	800W (AC1) resistive load	800W (AC1) resistive load
Solenoid valve	present	present
Compressor oil heater	present	present
Alarm relay	100W	100W

Capacitive load

The relays cannot be used for the direct connection of capacitive loads such as LEDs and on/off control of EC motors.

All loads with a switch mode power supply must be connected with a suitable contactor or similar.

Connection diagrams

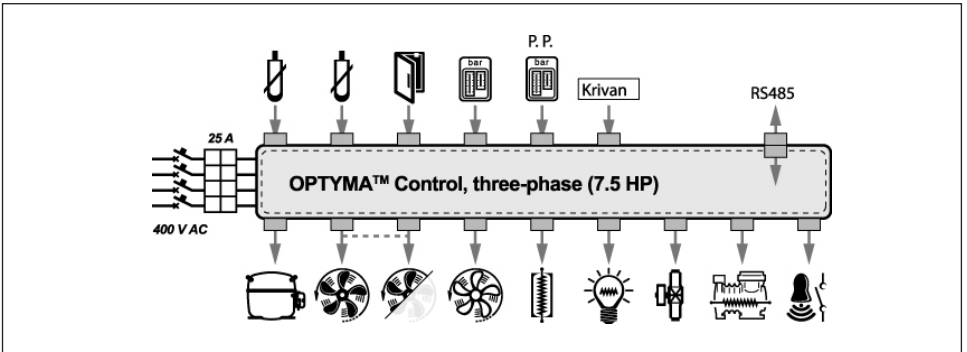
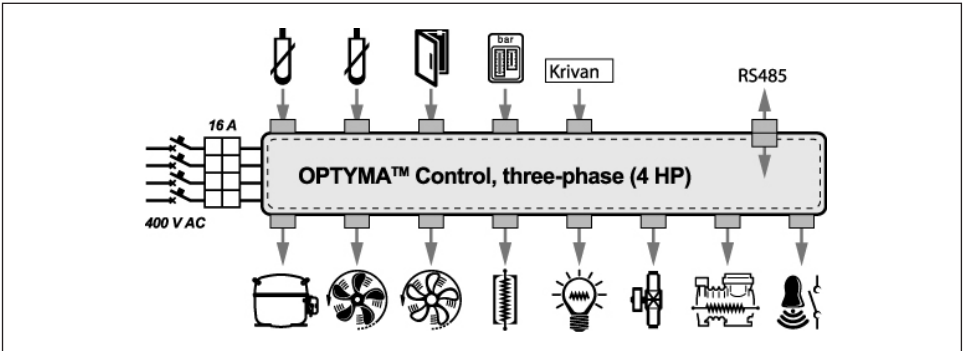

Overall dimensions



Dimensions in mm.

Identification data

A label bearing the following information is affixed to the side of the product described in this manual

- Name of manufacturer
- Product type and code number
- Product name
- Power supply
- Compressor range
- Serial number (10 digits)
- Date (Day/Month/Year)

Example:

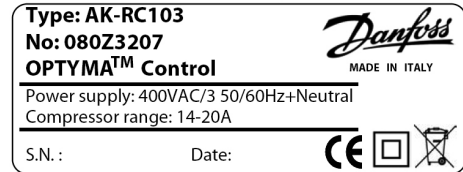

Transport and storage

Each control is carefully packaged to ensure that it arrives undamaged under normal transport conditions. Prior to transportation, please ensure that:

- **No objects or loose parts are inside the control.**
- **The door is correctly closed and locked.**
- **If the original packaging is not used, the product is sufficiently packaged to allow safe transportation**

The storage room must be of a suitable temperature and low humidity; avoid contact between the electrical control and aggressive contaminants that could impair functioning and electrical safety.

Installation

Installation to be done by authorised person only!

Standard assembly kit

The OPTYMA™ Control three-phase unit is supplied with:

- 4 rubber washers, to be fitted between the fixing screws and the housing back panel
- 1 operation and maintenance guide
- 1 wiring instruction.
- 1 drilling layout.
- 2 sensors

Mechanical assembly

- Each control is designed to be wall-mounted; please select an appropriate fixing method depending on the weight.
- Install the device in places where the protection rating is observed.
- To effect the correct electrical connection and maintain the protection rating, use appropriate cable glands and plugs to ensure a good seal.
- Install the device at an appropriate height for ease of use and maintenance. The installer must not be put at risk when working on the panel. The device must be located at a height of between 0.6 to 1.7 m from the ground.
- Install the device away from fire and heat sources and protect from the weather if necessary.

Installing the unit

1. Lift the transparent cover protecting.



2. Remove the screw cover on the right-hand side.

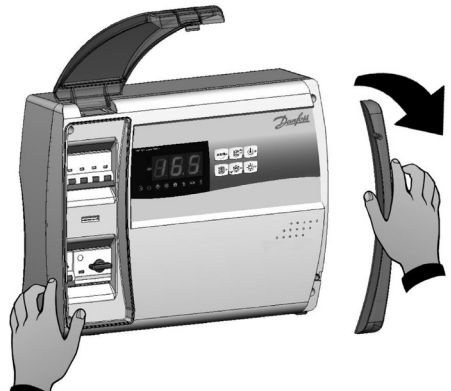

3. Undo the 4 fixing screws on the front of the cover.



Installing the unit
(continued)

- 4.**
Close the transparent protection cover.



- 5.**
Open the front of the housing, lift it and slide the two hinges out as far as they will go.

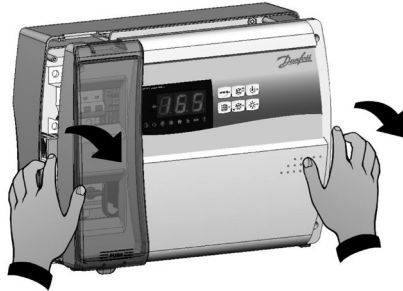

- 6.**
Bend the hinges and rotate the front panel by 180° downward to gain access to the inside of the panel; then disconnect the electronic card connector.

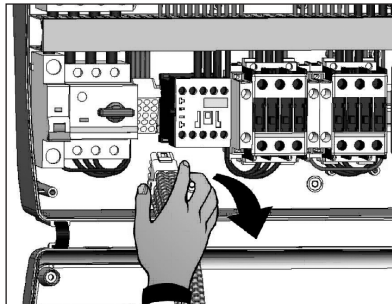

Installing the unit

(continued)

7.

Squeeze both sides of each hinge together to remove them from their seats and then completely remove the front panel.

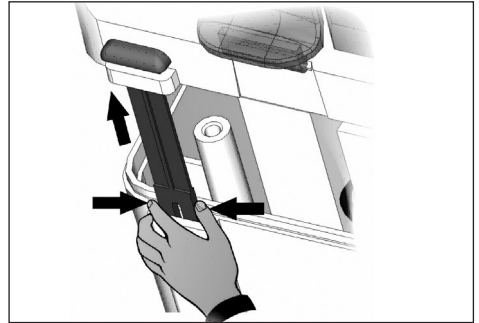

8.

Using a screwdriver, tap out the tabs in the 4 holes in the back panel in preparation for fixing it to the wall.

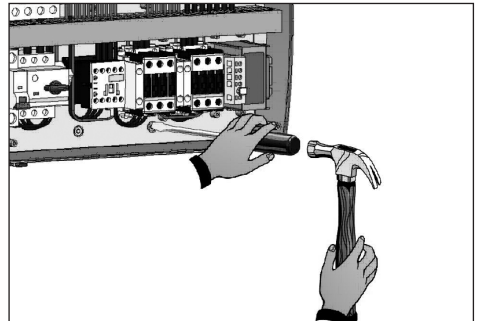

9.

Using the drilling guide provided, drill 4 fixing holes in the wall.

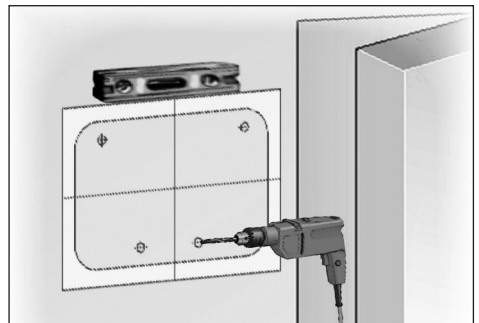

Installing the unit

(continued)

10.

Using the holes made in point 9 above, screw the back panel to the wall using 4 screws of a suitable length for the wall thickness. Fit a rubber washer (supplied) between each screw and the housing back panel.

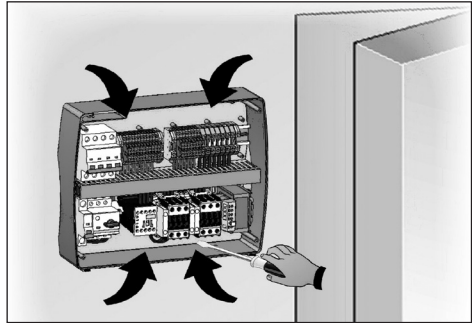

11.

Now do the electrical wiring as shown below.

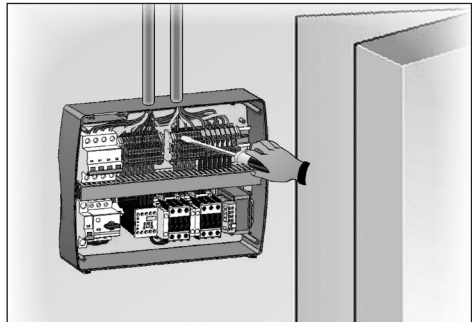

Electrical wirings

- For the electrical wiring please refer to the wiring instruction and technical characteristics of the controller being installed.
- The controller power supply must be on a dedicated line, and must be equipped with a suitable device to protect against indirect return of power in the wire.
- Do not route power supply wiring and signal wiring (sensors and digital inputs) in the same raceways or ducts.
- Do not use multi-polar cables which have wires connected to inductive/power loads and signalling wires (e.g. sensors and digital inputs).
- Minimise the length of connector wires so that wiring does not twist into a spiral shape, as this could have a detrimental effect on the electronics.
- If a probe/sensor extension is required, the wires must have a diameter of at least 1 mm².
- All wiring must be of a diameter suitable for the relevant power levels. The degree of insulation must be compatible with the applied voltages. Preferably use cables with flame-retardant insulation and a low smoke emission where fire regulations apply.
- **It is essential to connect the clamp marked PE to the earth of the supply system. If necessary, please check the effectiveness of the earthing system.**
- **Do not connect to the PE clamp conductors any different than the external protection.**

Front panel connection

Re-attach the front panel and reconnect the electronic card connector as shown below.

1. Re-attach the front panel to the lower part of the housing by inserting the two hinges in their seats.

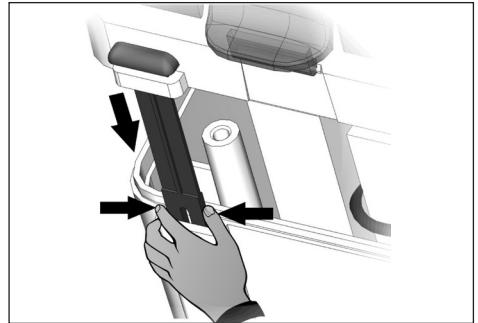

2. Bend the hinges and rotate the front panel downwards 180° to gain access to the inside of the housing and then reconnect the electronic card connector.

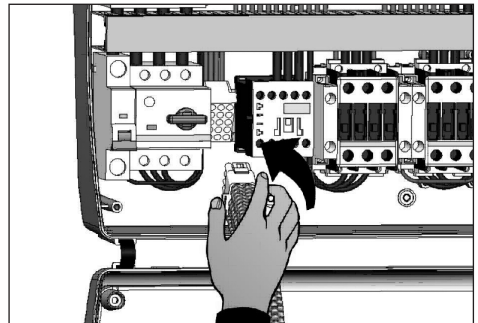

3. When using Alarm/Aux relay/Data communication, connect the wiring directly to the electronic card clamps. It is advisable to route these wires alongside the connection cables from the electronic card and the housing back panel.

If Modbus data communication is connected, see the JUMPER setting on page 21, preferably before all the wiring is connected.

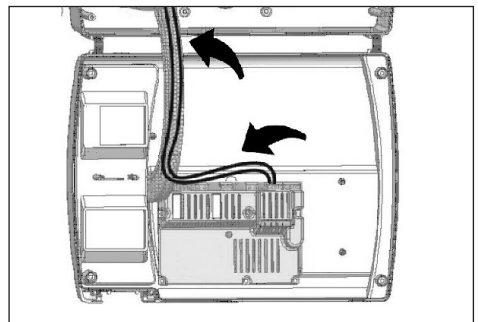

Checks before use

- Having completed the wiring, please check with the wiring diagram to ensure it has been done correctly.
- Check that the screw clamping is correct.
- If possible, check that the outside protection devices function correctly.
- Calibrate the motor protector for the compressor (if present) correctly as shown on the following pages.
- **After powering up the control, please check the correct current absorption on the loads, and after it has been running for a few hours check that the screws on the terminal blocks are sufficiently tight (including power supply line connection).**

Warning:

Please disconnect the power sectioning power supply upstream of the line and secure it with a padlock for max. safety, before tightening the screws. Before any operation, use a voltage detector to check that there is no voltage.

Calibrating of the motor protector for the compressor motor

Step-by-step instructions for calibrating of the motor protector for the compressor are given below:

1.
When starting the system for first time, it is advisable to calibrate the motor protector on the compressor power circuits. Use an ammeter to check the effective absorption.

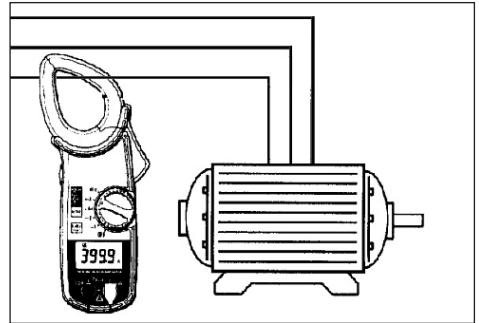

2.
Calibrate the motor protector based on the measured absorption. The set up value must not exceed that recommended by the compressor manufacturer.

Warning:

An incorrect calibration may cause compressor breakdown or bad intervention of the motor protector.

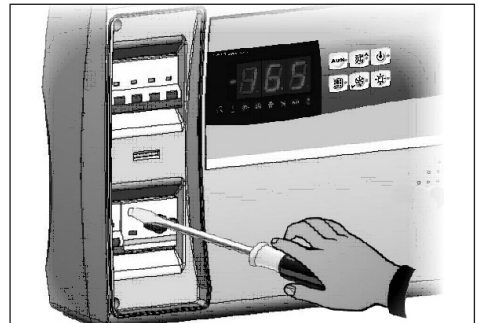

3.
To calibrate use the control screw on the front of motor protector.



Closing the control

Below is a step by step description on how to calibrate the motor protector dedicated to the compressor.

1.
Close the front panel, making sure that all the wires are inside the housing and that the housing seal is located securely in its seat

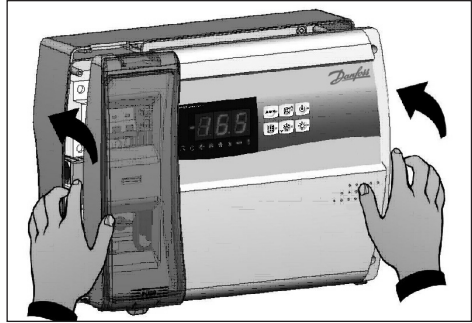

2.
Tighten the front panel using the 4 screws, making sure the rubber washers are used on the head of each screw.
Replace the screw cover on the right-hand side.



3.
Power up the control and carry out thorough reading/programming of all the parameters.



Control panel

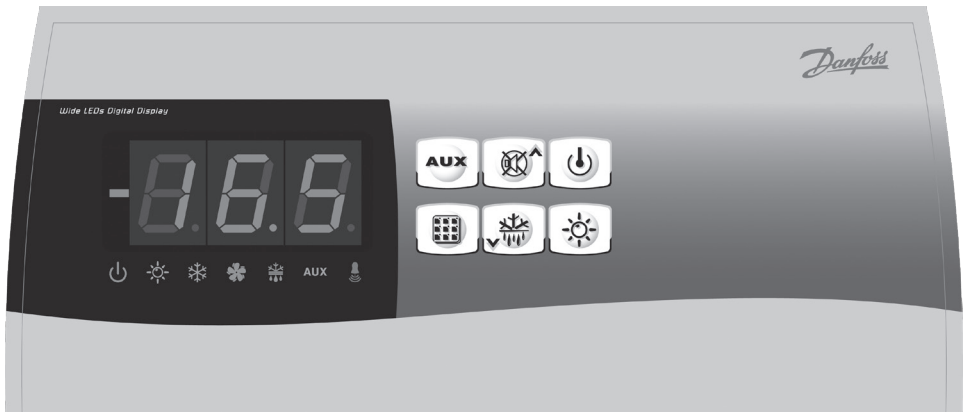

Front keypad

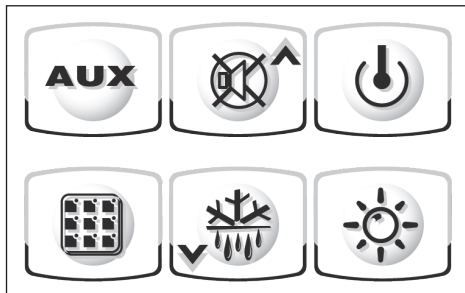

AUXILIARY RELAY CONTROL

(on the version with alarm relay controls the relay manual if parameter AU=1)



UP / MUTE WARNING BUZZER



STAND BY

(The LED flashes if the system shuts down)



Room temperature SETTING / SET key



DOWN / MANUAL DEFROST



ROOM LIGHT

LED display

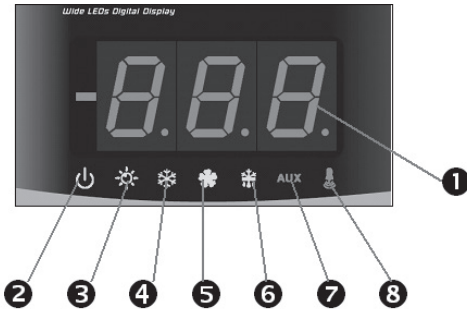

1. Cold room temperature / parameters
2. Stand-by (flashes on stand-by. Outputs are deactivated)
3. Room light (flashes if door switch is activated)
4. Cold (indicates activation of compressor)
5. Fans
6. Defrosting
7. Auxiliary
8. Alarm/warning



General

To enhance safety and simplify the operator's work, the OPTYMA™ Control has two programming levels; the first level (Level 1) is used to configure the frequently-modified SETPOINT parameters. The second programming level (Level 2) is for general parameter programming of the various controller operating modes.

It is not possible to access the Level 2 programming directly from Level 1: you must exit the programming mode first.

Symbols used

For practical purposes the following symbols are used:

- (▲) the UP key  is used to increase values and mute the alarm.
- (▼) the DOWN key  is used to decrease values and force defrosting.

Setting and displaying the setpoints

1. Press the SET key to display the current SETPOINT (temperature)
2. Hold down the SET key and press the (▲) or (▼) keys to modify the SETPOINT.

Release the SET key to return to cold room temperature display: the new setting will be saved automatically.

Level 1 - Programming (User Level)

To gain access to the Level 1 configuration menu proceed as follows:

1. Press the (▲) and (▼) keys simultaneously and keep them pressed for a few seconds until the first programming variable appears on the display.
2. Release the (▲) and (▼) keys.
3. Select the variable to be modified using the (▲) and (▼) key.
4. When the variable has been selected it is possible to:
 - display the setting by pressing SET key
 - modify the setting by pressing the SET key together with the (▲) and (▼) key.
5. The new settings are saved automatically when you exit the configuration menu.

When configuration values have been set exit the menu by pressing the (▲) and (▼) keys simultaneously for a few seconds until the cold room temperature reappears.

List of Level 1 variables (User Level)

Variables	Explanation	Value	Default
r0	Differential above main SETPOINT* * SETPOINT see page 16	0.2 - 10 K	2K
d0	Defrost interval (hours)	0 - 24 hours	4 hours
d2	End-of-defrost setpoint. Defrosting will not take place if the temperature detected by the defrost sensor is greater than d2 (If the sensor is faulty, defrosting is timed)	-35 - 45 °C	15°C
d3	Max defrost duration (minutes)	1 - 240 min	25 min
d7	Drip duration (minutes) At the end of defrost, the compressor and fans remain at standstill for time d7 and the defrost LED on the front panel flashes.	0 - 10 min	0 min
F5	Fan pause after defrost (minutes) Allows fans to be kept at standstill for time F5 after dripping. This time begins at the end of dripping. If no dripping has been set, the fan pause starts directly at the end of defrost.	0 - 10 min	0 min
A1	Minimum temperature alarm Allows user to define a minimum temperature for the room being refrigerated. Below value A1 an alarm trips: the alarm LED flashes, the displayed temperature flashes and the buzzer sounds to indicate the problem.	-	-45°C
A2	Maximum temperature alarm Allows user to define a maximum temperature for the room being refrigerated. Above value A2 an alarm trips: the alarm LED flashes, the displayed temperature flashes and the buzzer sounds to indicate the problem.	-	+45°C
tEu	Evaporator sensor temperature display	Displays evaporator temperature (displays nothing if dE=1)	read only

Level 2 - Programming (Installer Level)

To access the second programming level press the UP (▲) and DOWN (▼) keys and the LIGHT key simultaneously for a few seconds.

When the first programming variable appears the system automatically goes to stand-by.

1. Select the variable to be modified by pressing the UP (▲) and DOWN (▼) keys.
When the parameter has been selected it is possible to:

- view the setting by pressing the SET key.
 - modify the setting by holding the SET key down and pressing the (▲) or (▼) key.
2. When the configuration settings have been completed, exit the menu by pressing the (▲) and (▼) keys simultaneously and keep them pressed until the room temperature reappears.
 3. Changes are saved automatically when you exit the configuration menu.
 4. Press the STAND-BY key to enable electronic control.

List of Level 2 variables (Installer Level)

Variables	Explanation	Value	Default
AC	Door switch status	0 = normally open 1 = normally closed	0
F3	Fan status with compressor off	0 = fans run continuously 1 = fans only run when compressor is working	1
F4	Fan pause during defrost	0 = fans run during defrost 1 = fans do not run during defrost	1
dE	Sensor presence If the evaporator sensor is disabled defrosts are carried out cyclically with period d0: defrosting ends when an external device trips and closes the remote defrost contact or when time d3 expires.	0 = evaporator sensor present 1 = no evaporator sensor	0
d1	Defrost type With heater elements	0 = electrical 1 = reserved function. No effect.	0
bdr	Modbus baudrate (Danfoss System unit =19200 baud)	0=300. 1=600. 2=1200. 3=2400. 4=4800. 5=9600. 6=14400. 7=19200. 8=38400 baud.	7
Ad	Modbus address	1 ... 247 (+ setting: AU must be set to 7) (+ move jumper: see page 21)	0
Ald	Minimum and maximum temperature signalling and alarm display delay	1 - 240 min	120 min
C1	Minimum time between shutdown and subsequent switching on of the compressor.	0 - 15 min	0 min
CAL	Correction of sensor signal	-10 - +10	0
Pc	Compressor protection contact status	0 = NO 1 = NC	0 = NO
doC	Compressor safety time for door switch: when the door is opened, the evaporator fans shut down and the compressor will continue working for time doC, after which it will shut down.	0...5 minutes	0
tdo	Restart time, if the door remains open	0... 240 min. (0=no function)	0
Fst	Fan shutdown temperature The fans will stop if the temperature value detected by the evaporator sensor is higher than this value.	-45 - +45°C	+45°C
Fd	Fan differential below Fst	0 - +10K	2K

Continued...

Variables	Explanation	Value	Default
LSE	Min. limit of set point setting	-45...HSE	-45°C
HSE	Max. limit of set point setting	45... LSE	45°C
tA	NO – NC alarm relay switching	0 = activates when alarm is on 1 = deactivates when alarm is on	1
AU	Auxiliary/alarm relay control (only on version with relay fitted)	0 = alarm relay 1 = manual auxiliary relay controlled via AUX key 2 = automatic auxiliary relay managed by StA temp. setting with 2°C differential 3 = not used 4 = pump-down function (page 20) 5 = free voltage contact for condensing unit (AUX relay and compressor relay in parallel) 6 = Relay used to control a heating element in the crankcase. The relay is on when the compressor is stopped 7 = The relay function is cancelled and data communication is permitted.	0
StA	Temp. setting for aux. relay	-45...+45°C	0
In1	Man-in-cold-room alarm Select input INP1 on the board as compressor protection alarm or as man-in-cold-room alarm (contact NC).	0 = compressor protection 1 = man-in-cold-room alarm	0
P1	Password type of protection (active when PA does not equal 0)	0 = only display set point 1 = display set point, AUX, light access 2 = access to programming not permitted 3 = access to second level programming not permitted	3
PA	Password (see P1 for the type of protection)	0...999 0 = not active	0
reL	Software release	The version can be read	-

Switching on the OPTYMA™ Control three-phase

After correctly wiring the electronic control, connect to 400 V a.c. and the display panel will

immediately emit a beep and all the LEDs will come on simultaneously for a few seconds.

Compressor activation/deactivation conditions

The OPTYMA™ Control three-phase activates the compressor when the cold room temperature exceeds setting + differential (r0); it deactivates the

compressor when the cold room temperature is lower than the setting.

Manual defrosting

To defrost, just press the dedicated key (see page 15) to activate the elements relay. Defrosting will not take place if the end-of-defrost temperature setting (d2) is lower than the temperature detected

by the evaporator sensor. Defrosting ends when the end-of-defrost temperature (d2) or maximum defrost time (d3) is reached. When using data communication, the defrost cycle can be started from the system device.

Pump-down function

Select the PUMP-DOWN function mode for the compressor working on X1 terminal block, change the selection connection as indicated in the wiring diagram.

The AU parameter must never be set at 4, as the PUMP-DOWN function is made electromechanically inside the panel.

Password function

The protection function is activated when parameter PA is set with a value other than 0,. See parameter P1 for the different protection types. When PA is set, protection starts after two

minutes of inactivity. 000 appears on the display. Use the up/ down keys to change the number, and the set key to confirm it. Use the universal number 100 if you have forgotten the password.

Alarm/AUX RELAY SWITCHING / Data communication

Factory setting = The relay functions as an alarm relay.

When using data communication, a JUMPER must be moved.

See the following:

1. Open the front panel as described on page 7.
2. Bend the hinges and rotate the front panel downwards 180° to gain access to the electronic card.

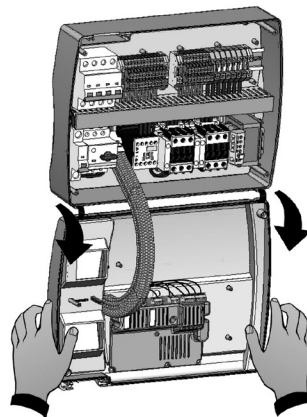
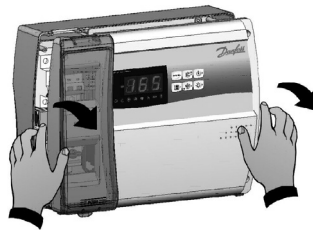

3. Undo the 6 CPU board cover fixing screws: remove the board from the front panel of the housing in ABS.

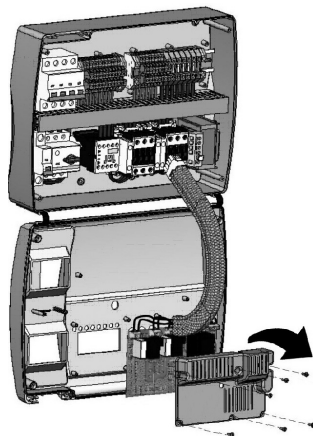

4. Remove the jumper from JUMPER JP2.

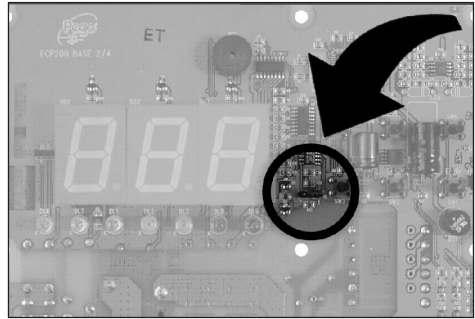

5. Insert the jumper in JUMPER JP2 in position:
3-2: to select data communication
(2-1: is the alarm relay position).

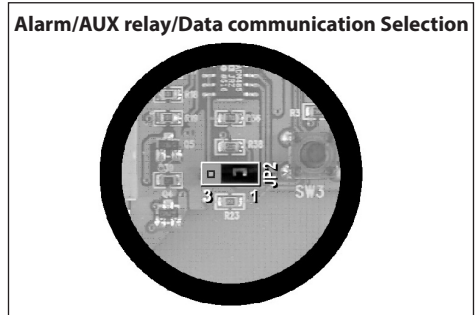

6. If Alarm/Aux relay/Data communication is used,
wire directly on the electronic card clamps.
It is advisable to route that wiring beside the
connection cables from electronic card and the
housing back panel.

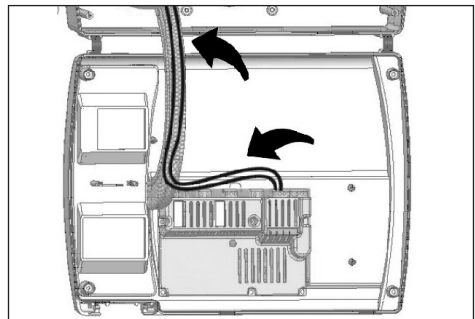

Alarm relay is connection 16-17.
Modbus data communication is connection 7-8.

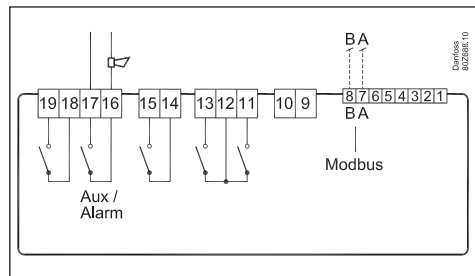

Alarm codes



In the event of any anomalies, the OPTYMA™ Control warns the operator by displaying alarm codes and sounding the warning buzzer inside the

control panel. If an alarm is tripped, the display will show one of the following messages:

Alarm code	Possible cause	Solution
E0	Cold room sensor not working properly	<ul style="list-style-type: none"> • Check that the cold room temperature sensor is working properly. • If the problem persists, replace the sensor.
E1	Defrost sensor not working properly (In this case defrosts will last time d3)	<ul style="list-style-type: none"> • Check that the defrost sensor is working properly. • If the problem persists, replace the sensor.
E2	Eeprom alarm An EEPROM memory alarm has been detected (All outputs except the alarm are deactivated)	<ul style="list-style-type: none"> • Switch unit off and back on again.
E8	Man-in-cold-room alarm	<ul style="list-style-type: none"> • Reset the alarm input inside the cold room
Ec	Compressor protection tripped (e.g. thermal protection or max. pressure switch) (All outputs except the alarm – where applicable – are deactivated)	<ul style="list-style-type: none"> • Check that compressor is working properly. • Check compressor absorption. • If the problem persists, contact the technical assistance service.
Ed	Open door - alarm (Open door and tdo-time has expired)	Check door / door contact
Temperature shown on display is flashing	<i>Minimum or maximum temperature alarm.</i> The temperature inside the cold room has exceeded the min. or max. temperature alarm setting (see variables A1 and A2 , user programming level)	<ul style="list-style-type: none"> • Check that the compressor is working properly. • Sensor not reading temperature correctly or compressor start/stop control not working.

Trouble shooting

In case no alarm code is present, some of the most common causes of anomalies are given below. These causes may relate to internal or external problems effecting the control.

Event	Possible cause	Solution
Compressor not starting Display is OFF	<i>No power supply</i>	<ul style="list-style-type: none"> • Check if display is ON and green light  is working. • Check the ambient sensor connections. • If the problem persists replace the sensor.
	<i>General automatic fuse intervention.</i>	<ul style="list-style-type: none"> • Before reinserting the automatic fuse, please check that there are no short-circuits. Then reinsert the automatic fuse, checking all the absorptions to identify any anomalies.
	<i>Auxiliary circuits automatic fuse intervention.</i>	<ul style="list-style-type: none"> • Before reinserting the automatic fuse please check that no short-circuits are present. Reinsert then automatic fuse verifying all the absorptions to identify any anomalies.
	<i>Circuit protection fuse (on the transformer) intervention.</i>	<ul style="list-style-type: none"> • Replace the fuse (fine fuse 10X20 F250mA 250V) . • Check that the transformer output absorption does not exceed 0.25A. • Check that no other users are connected to the clamps for Kriwan supply. • Check that there are no short-circuits on transformer output.
Compressor not starting	<i>The control is in stand-by mode</i>	<ul style="list-style-type: none"> • Check that the control is not in stand by mode (flashing green light ). If it is, press the  key to activate the control (continuous light).
	<i>Pressure switches or Kriwan malfunctioning have intervened.</i>	<ul style="list-style-type: none"> • Check wirings, calibration and correct functioning of compressor and sensors. • If starting the system for the very first time, please check that there is a bridge for pump-down/thermostat function selection on X1 terminal block. Make bridges on terminal block to accommodate devices not present in the system (Kriwan, pressure switches).
No defrosting cycle occurs	<i>Incorrect setting of defrosting cycle parameters</i>	<ul style="list-style-type: none"> • Check that the parameters are set correctly.

General safety instructions

Maintenance must be carried out only by skilled technicians.



Before carrying out any repairs or maintenance work on the electrical system, please disconnect the voltage to the control by placing the general power supply switch in the open position (O). Check the absence of voltage with a voltage detector before performing any operation. Replace any defective element of the control with original spare parts only.

If the correction is required on the outside of the control, proceed as follows:

- Safely switch off the control power supply in one of the following ways:
 - 1) Turn the OPTYMA™ Control main switch to the OFF position and secure the transparent polycarbonate front cover with a padlock.
 - 2) Cut off the power supply upstream of the permanently, using a padlock (on OFF position).
- Display signs indicating maintenance in progress.



Please observe these safety instructions before proceeding with maintenance operations:

- Ensure that the control is voltage-free.
- Prevent unauthorized personnel accessing the intervention area.
- Display suitable notices to indicate "Device isolated for maintenance".
- Wear suitable work clothing (overalls, gloves, shoes, headgear).
- Remove any item which could become entangled in any part of the control.
- Ensure that suitable tools for carrying out the maintenance operations are available.
- Ensure that the tools are correctly cleaned and greased.
- Ensure that all technical documentation required to carry out the maintenance work is present (wiring instructions, tables, drawings, etc....)
- On completion of the maintenance operation, please remove all the residual materials and carefully clean the inside of the control.

It is imperative that no additional parts are placed inside the control.

The manufacturer declines all responsibility in the event of failure to observe the points described on this page.

Maintenance

Maintenance is necessary to ensure the correct functioning of the control at all times and to prevent faulty components putting people at risk.

Maintenance work must be carried out by skilled and authorized technicians who observe the general safety instructions.

Device	Type of operation	Frequency
Terminal block	Wires tightening	After first 20 days of functioning
Terminal block	Wires tightening	Annual

Parts list

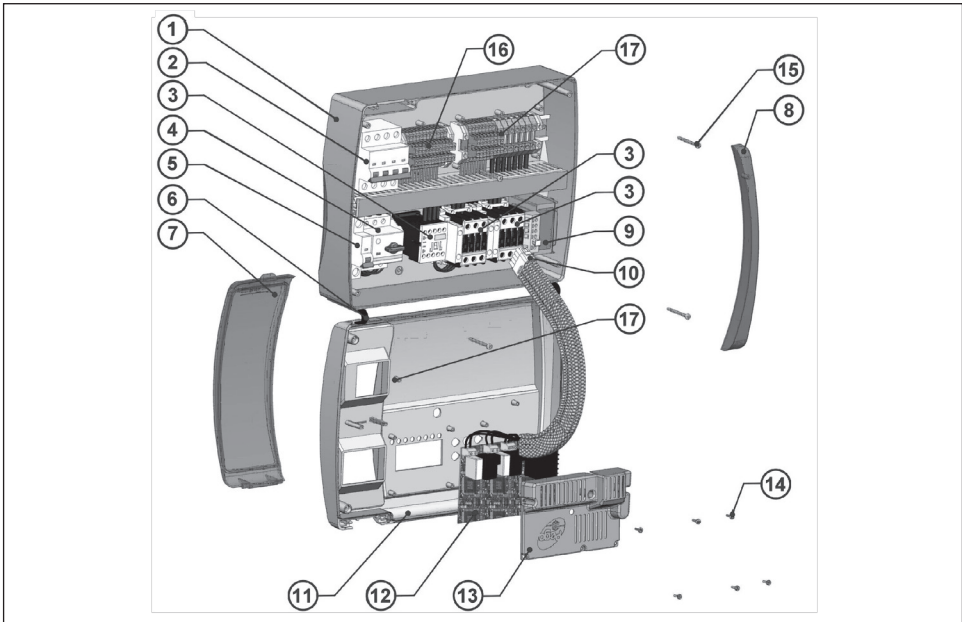

1	Housing back panel in ABS
2	4-pole automatic fuse
3	Contactors for units control
4	Motor protector for protection of compressor motor
5	Auxiliary protection 1-pole automatic fuse
6	Front panel opening hinges
7	Front cover in transparent polycarbonate
8	Transparent polycarbonate screw cover
9	Auxiliary circuits transformer (N.B. contains fine fuse 10X20 F250mA 250V)
10	Connector for linking control and electronic card
11	Housing front panel
12	Electronic card
13	Electronic card cover
14	Electronic card fixing screws
15	Housing closure screws
16	Auxiliary terminal block X1
17	Power terminal block X2

Note!

This part list is purely indicative.

Ordering

Type		Code no.
OPTYMA™ Control, three-phase (4 HP) including sensors	4.5-6.3 A	080Z3201
OPTYMA™ Control, three-phase (4 HP) including sensors	7-10 A	080Z3202
OPTYMA™ Control, three-phase (7.5 HP) including sensors	11-16 A	080Z3206
OPTYMA™ Control, three-phase (7.5 HP) including sensors	14-20 A	080Z3207
Sensor EKS 221 (spare part)		084N3210

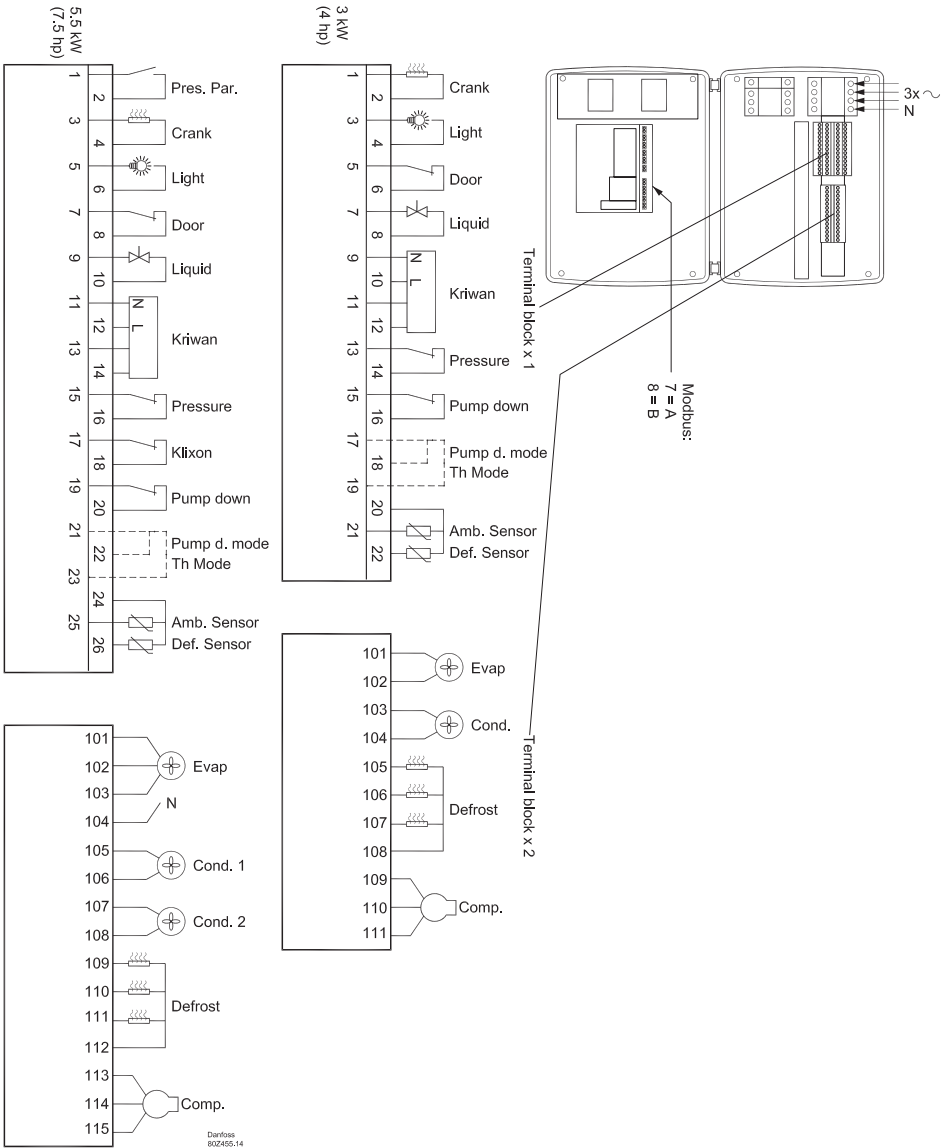

Danfoss can accept no responsibility for possible errors in catalogues, brochures and other printed material. Danfoss reserves the right to alter its products without notice. This also applies to products already on order provided that such alterations can be made without consequential changes being necessary in specifications already agreed. All trademarks in this material are property of the respective companies. Danfoss and the Danfoss logotype are trademarks of Danfoss A/S. All rights reserved.