

Installation Guide

VG, VGF, VGS, VGU, VGUF

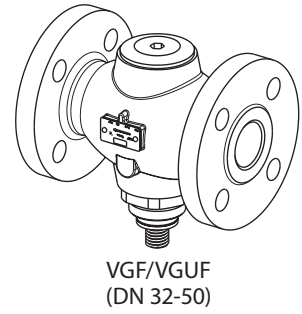

MAINTENANCE
FREE

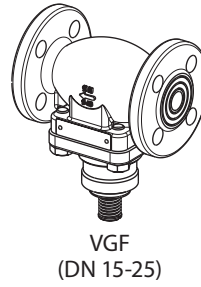
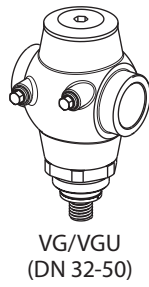
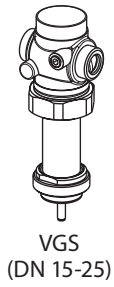

VG (DN 15-50)
VGF (DN 15-50)
VGS (15-25)
VGU (15-50)
VGUF (32-50)

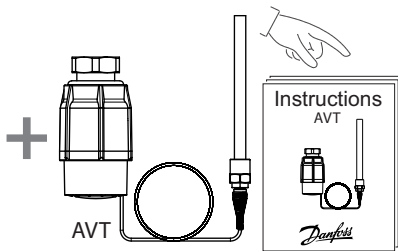

VG (DN 15-50)
VGF (DN 15-50)
VGS (15-25)

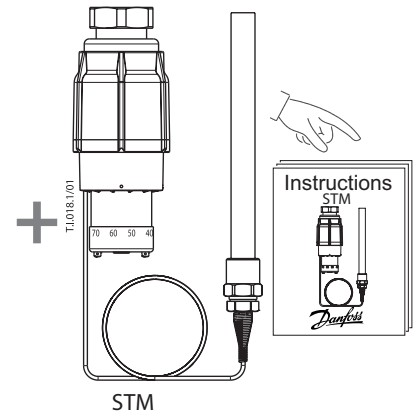

VGU (DN 15-50)
VGUF (DN 32-50)

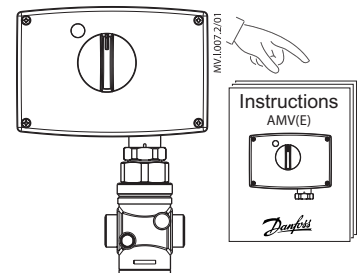
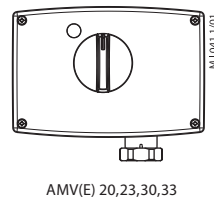
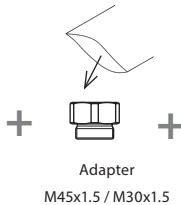

Installation Guide VG, VGF, VGS, VGU, VGUF

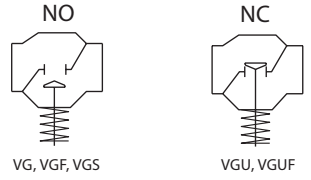
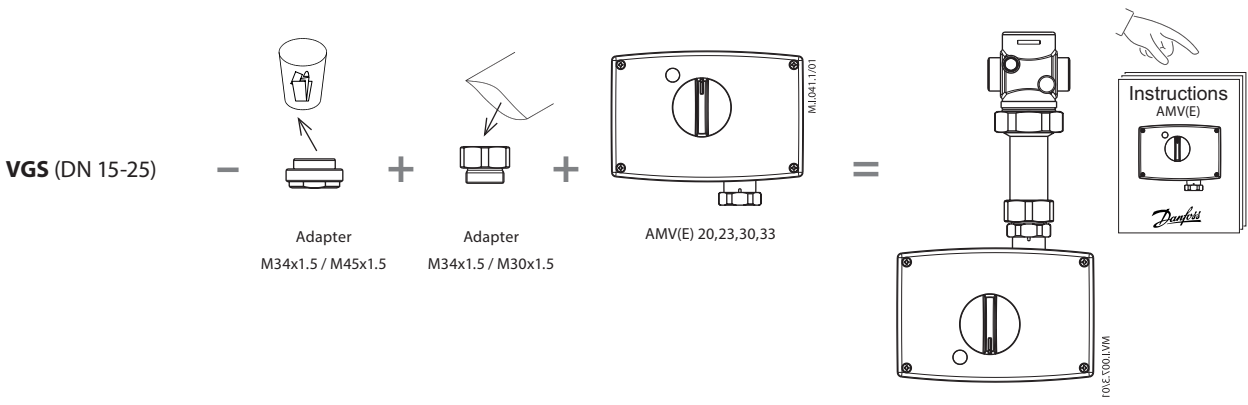

Valve type	PN	T _{max}	T _{min}
		°C	
VG	25	150	2
VGF	25	150	2
VGS	25	200	2
VGU	25	150	2
VGUF	25	150	2

According to EN 1092-2, EN 1092-3

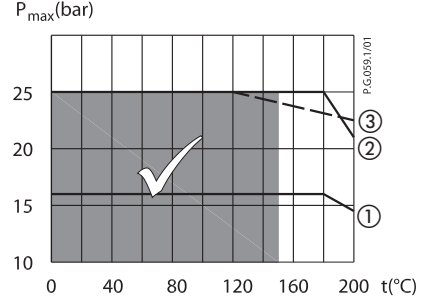

- ① CuSn5ZnPb (Rg5) PN 16
- ② CuSn5ZnPb (Rg5) PN 25
- ③ EN-GJS-400-18-LT (GGG 40.3) PN 25

Installation Guide VG, VGF, VGS, VGU, VGUF

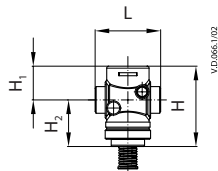

VGU DN 15-25

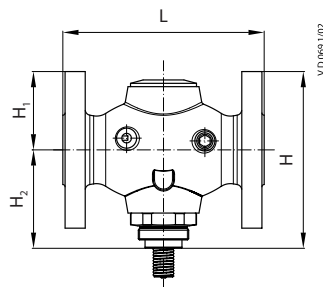

VGUF DN 32-50

VGU

DN	L	H	H ₁	H ₂	Weight (kg)
	mm				
15	65	80	34	46	0,7
20	70	80	34	46	0,8
25	75	83	37	46	0,9
32	100	154	63	91	3,2
40	110	154	63	91	3,3
50	130	154	63	91	4,1

VGUF

DN	L	H	H ₁	H ₂	Weight (kg)
	mm				
32	180	158	70	88	7,5
40	200	163	75	88	9,0
50	230	171	83	88	11,1

Note: other flange dimensions - see table for tailpieces

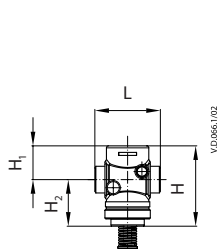

VG DN 15-25

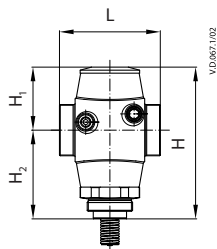

VG DN 32-50

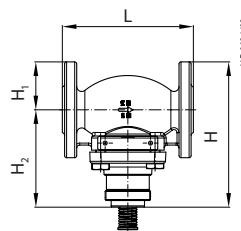

VGF DN 15-25

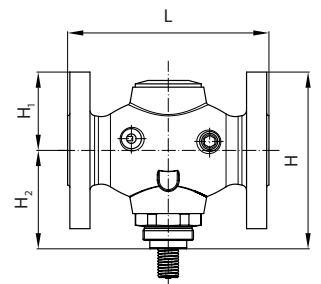

VGF DN 32-50

VG

DN	L	H	H ₁	H ₂	Weight (kg)
	mm				
15	65	80	34	46	0,7
20	70	80	34	46	0,8
25	75	83	37	46	0,9
32	100	154	63	91	3,0
40	110	154	63	91	3,1
50	130	154	63	91	3,8

VGF

DN	L	H	H ₁	H ₂	Weight (kg)
	mm				
15	130	144	48	96	3,3
20	150	149	53	96	4,1
25	160	154	58	96	4,7
32	180	158	70	88	7,5
40	200	163	75	88	9,0
50	230	171	83	88	11,1

Note: other flange dimensions - see table for tailpieces

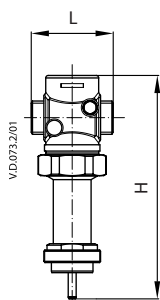

DN	15	20	25	
VGS	L	65	70	75
	H	156,5	155	158,5
	Weight	kg	0,7	0,8

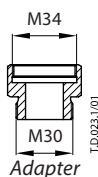

M34 × 1,5 mm / M30 × 1,5 mm

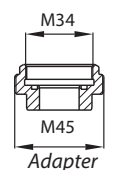

M34 × 1,5 mm / M45 × 1,5 mm

Installation Guide VG, VGF, VGS, VGU, VGUF

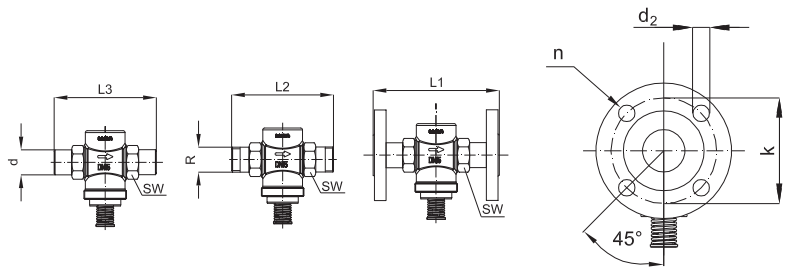

DN		15	20	25	32	40	50
SW		32 (G ¾A)	41 (G 1A)	50 (G 1¼A)	63 (G 1¾A)	70 (G 2A)	82 (G 2½A)
d		21	26	33	42	47	60
R ¹⁾		½	¾	1	1 ¼	-	-
L1 ²⁾		130	150	160	-	-	-
L2	mm	131	142	159	172	-	-
L3		139	154	159	184	244	298
k		65	75	85	100	110	125
d ₂		14	14	14	18	18	18
n		4	4	4	4	4	4

¹⁾ Conical ext. thread acc. to EN 10266-1
²⁾ Flanges PN 25, acc. to EN 1092-2

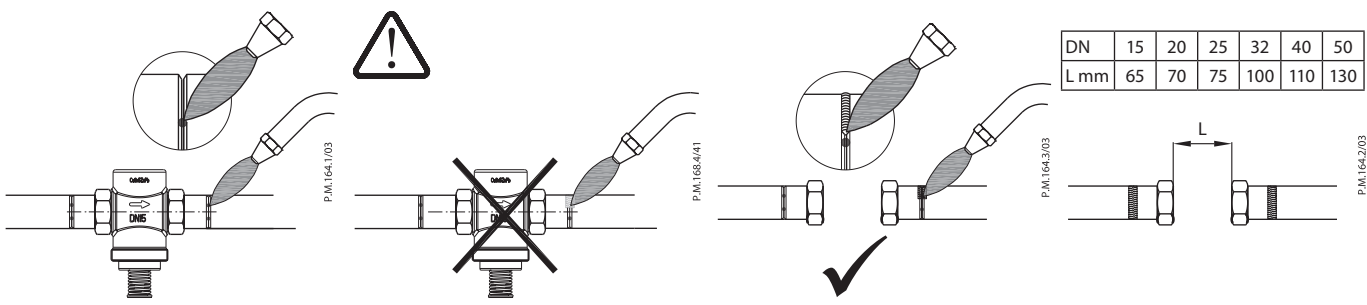

Danfoss can accept no responsibility for possible errors in catalogues, brochures and other printed material. Danfoss reserves the right to alter its products without notice. This also applies to products already on order provided that such alterations can be made without subsequential changes being necessary in specifications already agreed. All trademarks in this material are property of the respective companies. Danfoss and the Danfoss logotype are trademarks of Danfoss A/S. All rights reserved.