

ENGINEERING
TOMORROW



User Guide

Capacity controller for water chillers

AK-CH 650 SW 2.0

ADAP-KOOL® Refrigeration control systems

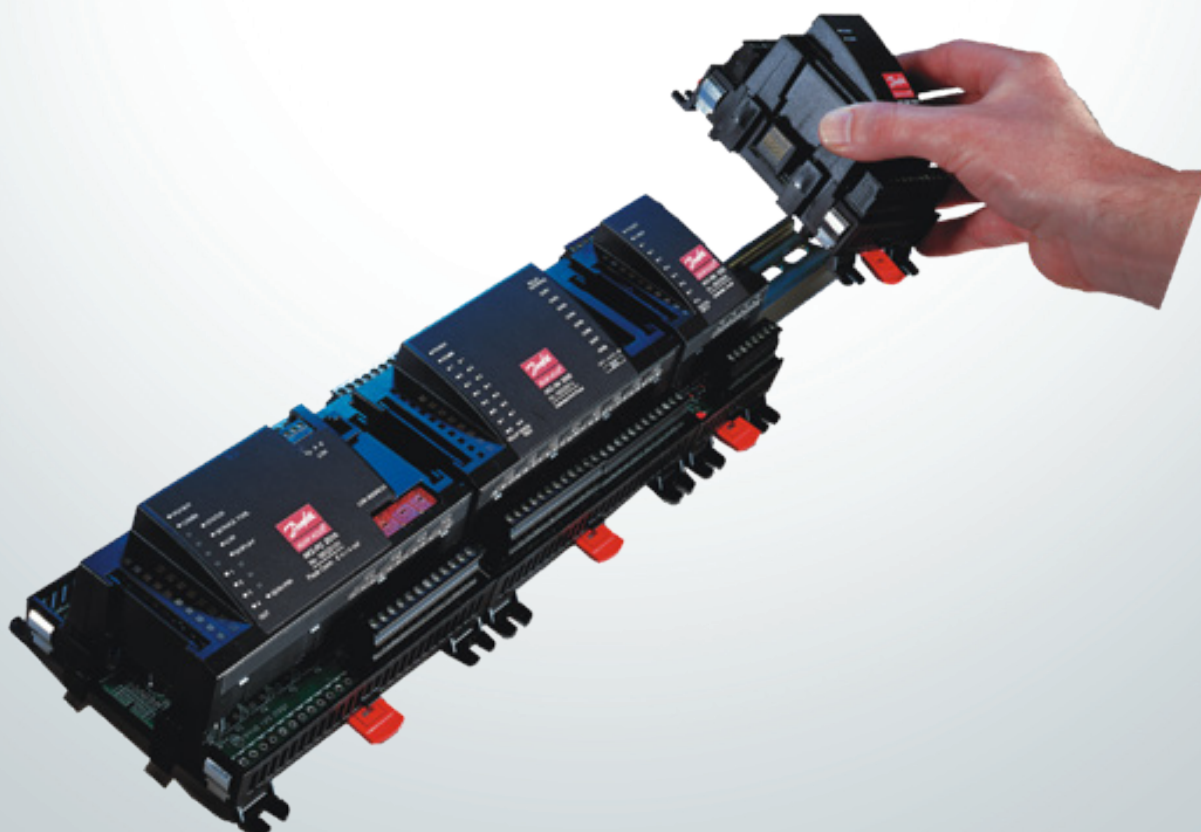

Contents

1. Introduction	3	4. Configuration and operation.....	45
Application.....	3	Configuration.....	47
Principles.....	4	Connect PC.....	47
2. Design of a controller	7	Authorization.....	48
Module survey.....	8	System setup	50
Common data for modules.....	10	Set plant type	51
Controller	12	Set control of compressors.....	52
Extension module AK-XM 101A.....	14	Setup control of condenser.....	55
Extension module AK-XM 102A / AK-XM 102B.....	16	Setup Display.....	57
Extension module AK-XM 103A.....	18	Setup defrost	58
Extension module AK-XM 204A / AK-XM 204B.....	20	Setup general alarm inputs.....	59
Extension module AK-XM 205A / AK-XM 205B.....	22	Setup separate thermostat functions.....	60
Extension module AK-OB 110	24	Setup separate voltage functions	61
Extension module AK-OB 101A.....	25	Configuration of inputs and outputs.....	62
Extension module EKA 163B / EKA 164B.....	26	Set alarm priorities.....	64
Power supply module AK-PS 075 / 150.....	27	Lock configuration.....	66
Preface to design	28	Check configuration.....	67
Functions.....	28	Check of connections.....	69
Connections.....	29	Check of settings.....	71
Limitations.....	29	Schedule function	73
Design of a compressor and condenser control	30	Installation in network.....	74
Procedure:.....	30	First start of control.....	75
Sketch.....	30	Check alarms.....	75
Compressor and condenser functions	30	Start the control.....	76
Connections.....	31	Manual capacity control	77
Planning table	33	Manual defrost.....	78
Length	34	5. Regulating functions.....	79
Linking of modules.....	34	Suction group	80
Determine the connection points	35	Capacity control of compressors.....	80
Connection diagram	36	Reference for compressor control.....	81
Supply voltage	37	Capacity distribution methods.....	82
Ordering.....	38	Power pack types – compressor combinations.....	82
3. Mounting and wiring.....	39	Load shedding.....	87
Mounting.....	40	Liquid injection in suction line	88
Mounting of analog output module.....	40	Heat exchanger injection	88
Mounting of extension module on the basic module.....	41	Defrost.....	89
Wiring.....	42	Safety functions.....	90
		Pump control	92
		Condenser	93
		Capacity control of condenser	93
		Reference for condensing pressure.....	94
		Capacity distribution	95
		Step regulation	95
		Speed regulation	95
		Condenser couplings.....	96
		Safety functions for condenser	96
		General monitoring functions	97
		Miscellaneous	98
		Appendix A – Compressor combinations and coupling patterns.....	101
		Appendix B - Alarm texts	108
		Appendix C -	110
		Recommended connection	110

1. Introduction

Application

AK-CH 650 is a water chiller control for capacity control of compressors and air-cooled condensers on indirect refrigeration systems within commercial refrigeration.

In addition to capacity control, the controller can control pumps, injection signals to heat exchangers, defrosting sequences and safety monitoring, etc.

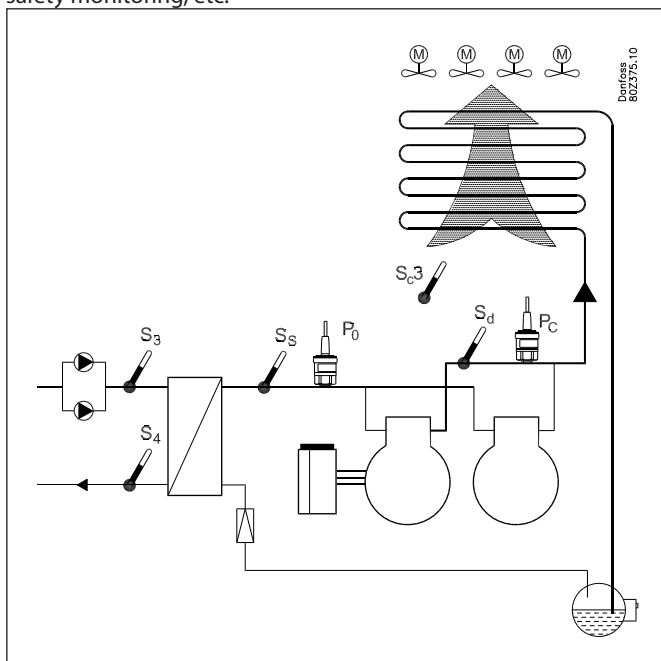

The controller uses the following signals for control/monitoring:

S4	Charge temperature (control signal)
S3	Return temperature
Ss	Suction gas temperature
Sd	Discharge gas temperature
Po	Suction pressure (frost-proofing).
Pc	Condensing pressure
S7	Return temperature for any hot brine
Sc3	Ambient temperature

Compressor capacity is controlled by charge temperature S4 and by suction pressure P0 as frost protection. Condenser capacity is controlled by condensing pressure Pc or, alternatively, temperature sensor S7.

Among the different functions are:

- Capacity control of up to 6 compressors (max. 3 unloads/comp)
- Relay output, which is activated by a request for extra cooling
- Speed control of one or two compressors
- Up to 6 safety inputs for each compressor
- Capacity limitation to minimize consumption peaks
- Twin pump control with automatic operating time equalisation
- Start/stop signal for heat exchanger injection, incl. pump down function
- Defrost control with time or temperature stop
- Liquid injection into suction line
- Safety monitoring of high pressure / low pressure / discharge temperature
- Frost protection
- Capacity control of up to 8 fans
- Floating condenser reference with regard to outside temperature
- Heat recovery function
- Fan capacity with regard to Step coupling, speed regulation or a combination
- Safety monitoring of fans
- Alarm signals can be generated directly from the controller and via data communication
- Alarms are shown with texts so that the cause of the alarm is easy to see.
- Plus some completely separate functions that are totally independent of the regulation – such as alarm inputs, thermostats, pressostat and voltage inputs.

Example

If the condenser end needs full control of a dry refrigeration circuit, AK-CH 650 can be combined with a type AK-PC 420 dry refrigeration control.

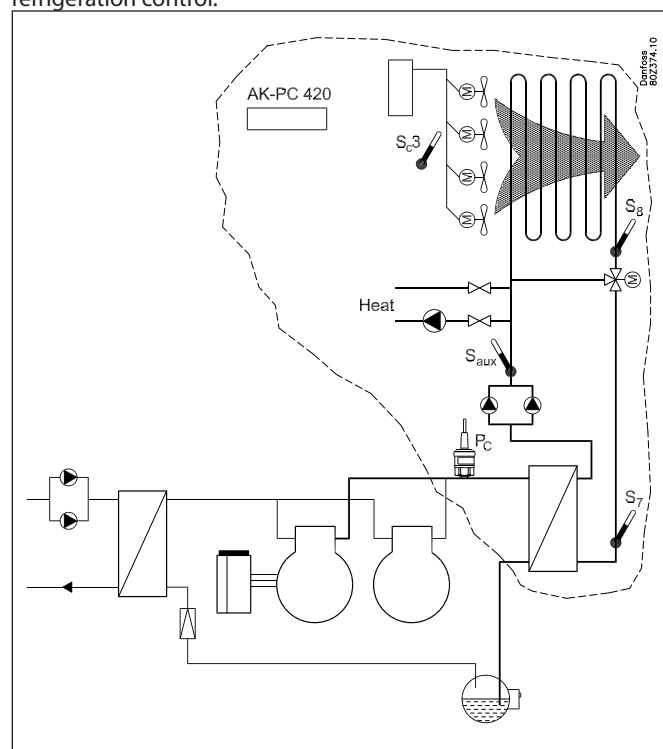

Principles

The great advantage of this series of controllers is that it can be extended as the size of the plant is increased. It has been developed for refrigeration control systems, but not for any specific application – variation is created through the read-in software and the way you choose to define the connections. It is the same modules that are used for each regulation and the composition can be changed, as required. With these modules (building blocks) it is possible to create a multitude of various kinds of regulations. But it is you who must help adjusting the regulation to the actual needs – these instructions will assist you to find your way through all the questions so that the regulation can be defined and the connections made.

Advantages

- The controller's size can "grow" as systems grow
- The software can be set for one or more regulations
- Several regulations with the same components
- Extension-friendly when systems requirements are changed
- Flexible concept:
 - Controller series with common construction
 - One principle – many regulation uses
 - modules are selected for the actual connection requirements
 - The same modules are used from regulation to regulation

Controller

Top part

Bottom part

The controller is the cornerstone of the regulation. The module has inputs and outputs capable of handling small systems.

- The bottom part – and hence the terminals – are the same for all controller types.
- The top part contains the intelligence with software. This unit will vary according to controller type. But it will always be supplied together with the bottom part.
- In addition to the software the top part is provided with connections for data communication and address setting.

Extension modules

If the system grows and more functions have to be controlled, the regulation can be extended. With extra modules more signals can be received and more relays cut in and out – how many of them – and which – is determined by the relevant application.

Examples

A regulation with few connections can be performed with the controller module alone

If there are many connections one or more extension modules have to be mounted

Direct connection

Setup and operation of an AK controller must be accomplished via the "AK-Service Tool" software program.

The programme is installed on a PC, and setup and operation of the various functions are carried out via the controller's menu displays.

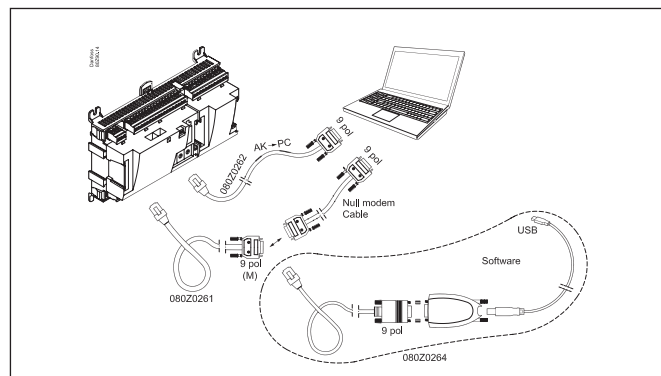

Displays

The menu displays are dynamic, so that different settings in one menu will result in different setting possibilities in other menus.

A simple application with few connections will give a setup with few settings.

A corresponding application with many connections will give a setup with many settings.

From the overview display there is access to further displays for the compressor regulation and the condenser regulation.

At the bottom of the display there is access to a number of general functions, such as "time table", "manual operation", "log function", "alarms", and "service" (configuration).

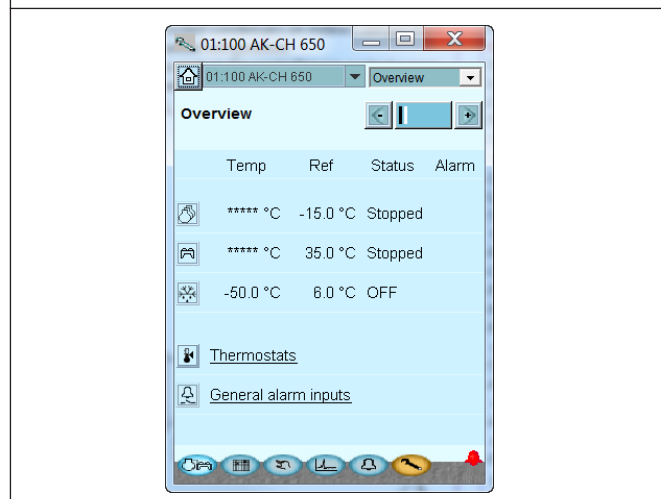

Network linking

The controller can be linked up into a network together with other controllers in an ADAP-KOOL® refrigeration control system. After the setup operation can be performed at a distance with, say, our software program type AKM.

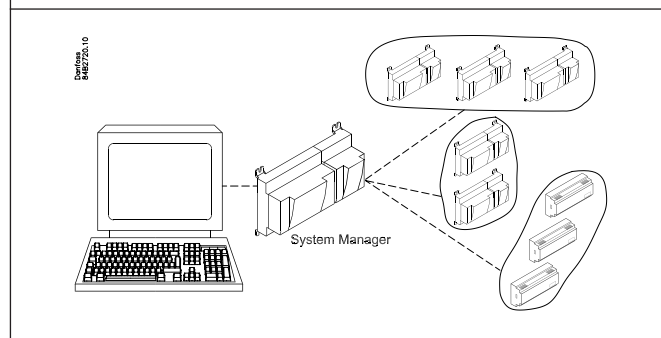

Users

The controller comes supplied with several languages, one of which can be selected and employed by the user. If there are several users, they may each have their choice of language. All users must be assigned a user profile which either gives access to full operation or gradually limits the operation to the lowest level that only allows you "to see".

Language selection is part of the service tool settings.

If the language selection is not available in the service tool for the current regulator, English texts will be displayed.

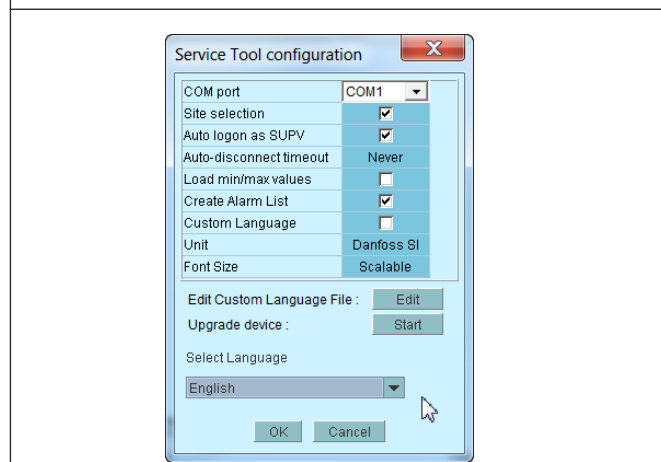

External display

An external display can be fitted in order for P0 (Suction) and Pc (Condensing) readings to be displayed.

A total of 4 displays can be fitted and with one setting it is possible to choose between the following readings: suction pressure, suction pressure in temperature, S3, S4, Ss, Sd, condenser pressure, condenser pressure in temperature and S7.

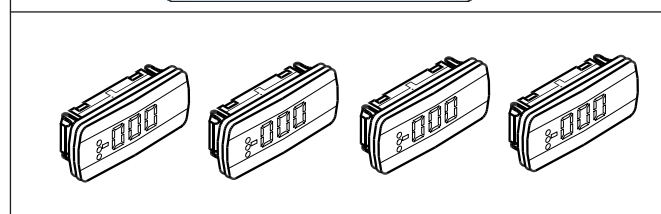

Light-emitting diodes

A number of light-emitting diodes makes it possible to follow the signals that are received and transmitted by the controller.

Log

From the log function you can define the measurements you wish to be shown.

The collected values can be printed, or you may export them to a file. You can open the file in Excel.

If you are in a service situation you can show measurements in a trend function. The measurements are then made realtime and displayed instantly.

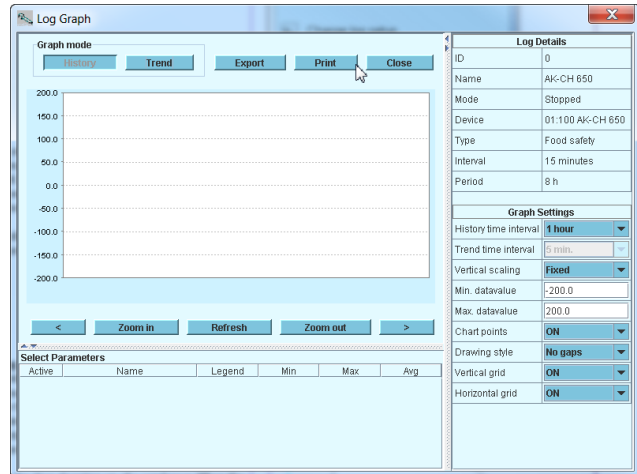

Alarm

The display gives you an overview of all active alarms. If you wish to confirm that you have seen the alarm you can cross it off in the acknowledge field.

If you want to know more about a current alarm you can click on it and obtain an information display on the screen.

A corresponding display exists for all earlier alarms. Here you can upload information if you need further details about the alarm history.

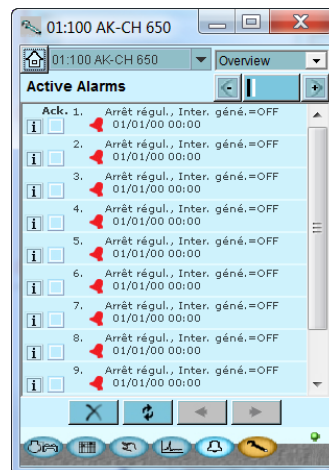

Trouble-shooting

The controller contains a function that continuously follows a number of measurements and deals with them. The result indicates whether the function is OK or whether an error may be expected within a given period of time ("the trip down the rollercoaster has started"). At this time an alarm is transmitted about the situation – no error has appeared as yet, but it will come.

One example may be slow clogging-up of a condenser. When the alarm comes the capacity has been reduced, but the situation is not serious. There will be time to plan a service call.

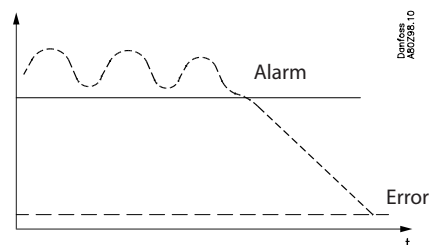

2. Design of a controller

This section describes how the controller is designed.

The controller in the system is based on a uniform connection platform where any deviations from regulation to regulation is determined by the used top part with a specific software and by which input and output signals the relevant application will require. If it is an application with few connections, the controller module (top part with belonging bottom part) may be sufficient. If it is an application with many connections it will be necessary to use the controller module plus one or more extension modules.

This section will give you a survey of possible connections plus assistance in selecting the modules required by your actual application.

Module survey

- Controller module – capable of handling minor plant requirements.
- Extension modules. When the complexity becomes greater and additional inputs or outputs are required, modules can be attached to the controller. A plug on the side of the module will transmit the supply voltage and data communication between the modules.
- Top part
The upper part of the controller module contains the intelligence. This is the unit where the regulation is defined and where data communication is connected to other controllers in a bigger network.
- Connection types
There are various types of inputs and outputs. One type may, for example, receive signals from sensors and switches, another may receive a voltage signal, and a third type may be outputs with relays etc. The individual types are shown in the table below.
- Optional connection
When a regulation is planned (set up) it will generate a need for a number of connections distributed on the mentioned types. This connection must then be made on either the controller module or an extension module. The only thing to be observed is that the types must not be mixed (an analog input signal must for instance not be connected to a digital input).
- Programming of connections
The controller must know where you connect the individual input and output signals. This takes place in a later configuration where each individual connection is defined based on the following principle:
 - to which module
 - at which point ("terminals")
 - what is connected (e.g. pressure transmitter/type/pressure range)

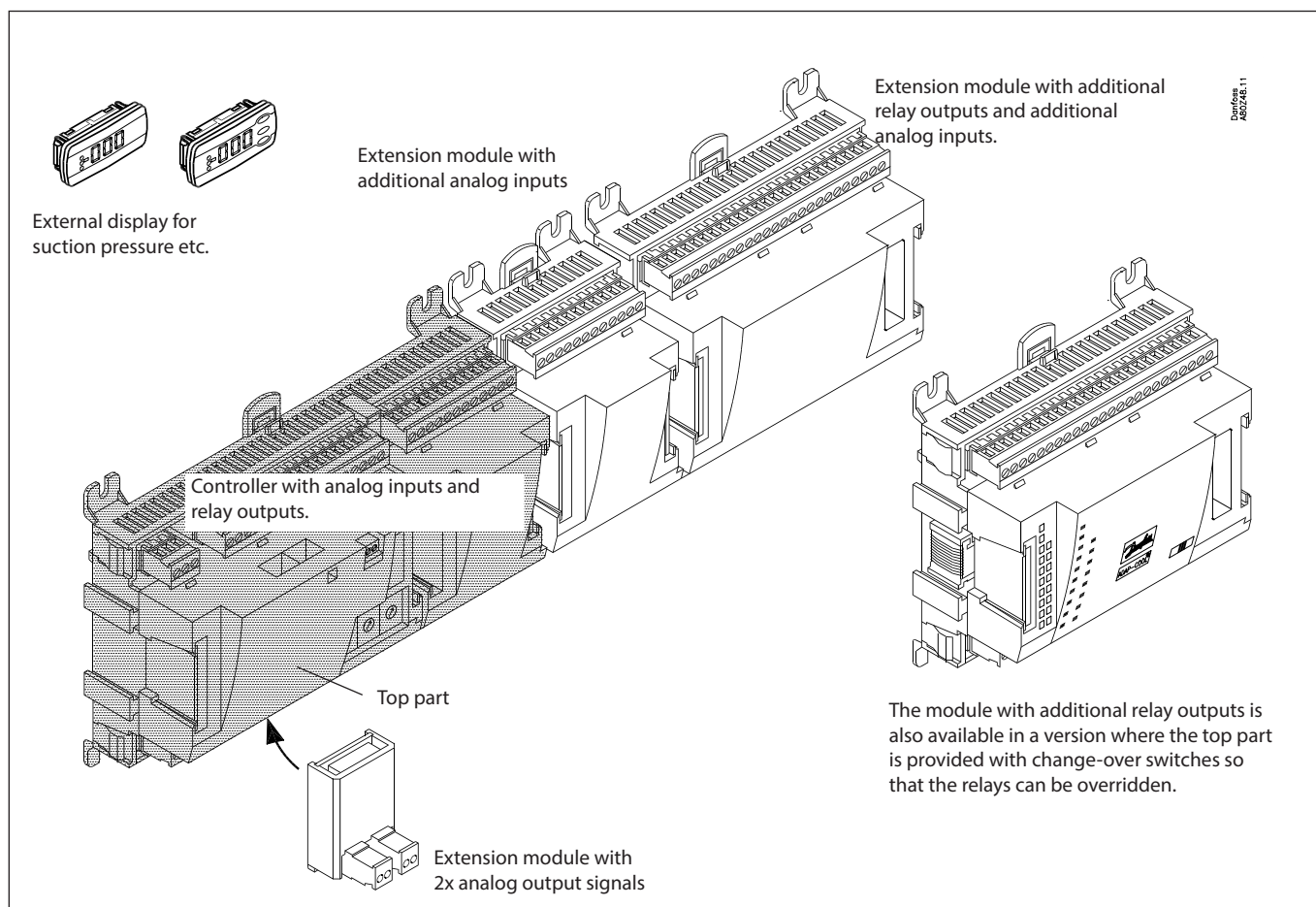

1. Controller

Type	Function	Application
AK-CH 650	Controller for capacity control of compressors and condensers	Extended water chiller control

2. Extension modules and survey of inputs and outputs

Type	Analog inputs	On/Off outputs		On/off supply voltage (DI signal)		Analog outputs	Module with switches
	For sensors, pressure transmitters etc.	Relay (SPDT)	Solid state	Low voltage (max. 80 V)	High voltage (max. 260 V)	0-10 V d.c.	For override of relay outputs
Controller	11	4	4	-	-	-	-
Extension modules							
AK-XM 101A	8						
AK-XM 102A				8			
AK-XM 102B					8		
AK-XM 103A	4					4	
AK-XM 204A		8					
AK-XM 204B		8					x
AK-XM 205A	8	8					
AK-XM 205B	8	8					x

The following extension module can be placed on the PC board in the controller module. There is only room for one module.

AK-OB 110						2	
-----------	--	--	--	--	--	---	--

3. AK operation and accessories

Type	Function	Application
Operation		
AK-ST 500	Software for operation of AK controllers	AK-operation
-	Cable between PC and AK controller	AK - Com port
-	Cable between zero modem cable and AK controller / Cable between PDA cable and AK controller	AK - RS 232
-	Cable set + converter between PC and AK controller	AK - USB
Accessories		
Power supply module 230 V / 115 V to 24 V		
AK-PS 075	18 VA	Forsyning til regulator
AK-PS 150	36 VA	
Accessories		
External display that can be connected to the controller module. For showing, say, the suction pressure		
EKA 163B	Display	
EKA 164B	Display with operation buttons	
-	Cable between display and controller	Length = 2 m Length = 6 m
Accessories		
Real time clock for use in controllers that require a clock function, but are not wired with data communication.		
AK-OB 101A	Real time clock with battery backup.	To be mounted in an AK controller

On the following pages there is data specific to each module.

Common data for modules

Supply voltage	24 V d.c./a.c. +/- 20%	
Power consumption	AK-__ (controller)	8 VA
	AK-XM 101, 102	2 VA
	AK-XM 204, 205	5 VA
Analoge indgange	Pt 1000 ohm /0°C	Resolution: 0.1°C Accuracy: +/- 0.5°C between -50°C and +50°C +/- 1°C between -100°C and -50°C +/- 1°C between +50°C and +130°C
	Pressure transmitter type AKS 32R / AKS 2050 / AKS 32 (1-5 V)	Resolution: 1 mV Accuracy +/- 10 mV Max. connection of 5 pressure transmitters on one module
	Other pressure transmitter: Ratiometric signal Min. and Max. pressure must be set	
	Voltage signal 0-10 V	
	Contact function (On/Off)	On at R < 20 ohm Off at R > 2K ohm (Gold -plated contacts not necessary)
On/off supply voltage inputs	Low voltage 0 / 80 V a.c./d.c.	Off: U < 2 V On: U > 10 V
	High voltage 0 / 260 V a.c.	Off: U < 24 V On: U > 80 V
Relay outputs SPDT	AC-1 (ohmic)	4 A
	AC-15 (inductive)	3 A
	U	Min. 24 V Max. 230 V Low and high voltage must not be connected to the same output group
Solid state outputs	Can be used for loads that are cut in and out frequently, e.g. : rail heat, fans and AKV valve	Max. 240 V a.c. , Min. 48 V a.c. Max. 0.5 A, Leak < 1 mA Max. 1 AKV
Ambient temperature	During transport	-40 to 70°C
	During operation	-20 to 55°C , 0 to 95% RH (non condensing) No shock influences / vibrations
Enclosure	Material	PC / ABS
	Density	IP10 , VBG 4
	Mounting	For mounting on panel wall or DIN rail
Weight with screw terminals	modules in 100- / 200- / controller-series	Ca. 200 g / 500 g / 600 g
Approvals	EU low voltage directive and EMC requirements are complied with	LVD tested according to EN 60730 EMC tested Immunity according to EN 61000-6-2 Emission according to EN 61000-6-3
	UL 873, us	UL file number: E31024 for CH UL file number: E166834 for XM

The mentioned data applies to all modules.
If data is specific, this is mentioned together with the module in question.

Capacitive load

The relays cannot be used for the direct connection of capacitive loads such as LEDs and on/off control of EC motors.
All loads with a switch mode power supply must be connected with a suitable contactor or similar.

Dimensions

The module dimension is 72 mm.

Modules in the 100-series consist of one module

Modules in the 200-series consist of two modules

Controllers consist of three modules

The length of an aggregate unit = $n \times 72 + 8$

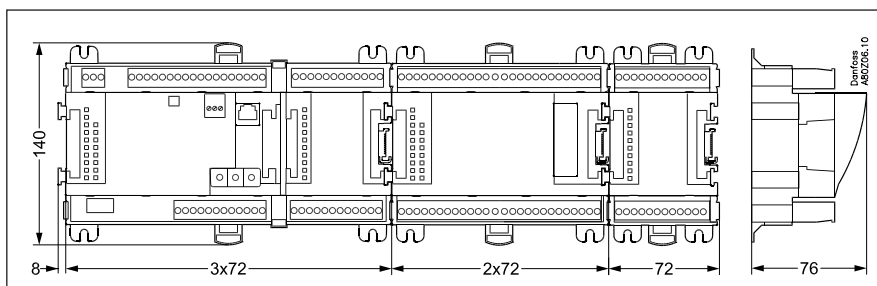

Controller

Function

There are several controllers in the series. The function is determined by the programmed software, but outwardly the controllers are identical – they all have the same connection possibilities:

- 11 analog inputs for sensors, pressure transmitters, voltage signals and contact signals.
- 8 digital outputs, with 4 Solid state outputs and 4 relay outputs

Supply voltage

24 V a.c. or d.c. to be connected to the controller.

The 24 V must **not** be retransmitted and used by other controllers as it is not galvanically separated from inputs and outputs. In other words, you **must** use a transformer for each controller. Class II is required. The terminals must **not** be earthed.

The supply voltage to any extension modules is transmitted via the plug on the right-hand side.

The size of the transformer is determined by the power requirement of the total number of modules.

The supply voltage to a pressure transmitter can be taken either from the 5 V output or from the 12 V output depending on transmitter type.

Data communication

If the controller is to be included in a system, communication must take place via the LON connection. The installation has to be made as mentioned in the separate instructions for LON communication.

Address setting

When the controller is connected to a gateway type AKA 245, the controller's address must be set between 1 and 119.

Service PIN

When the controller is connected to the data communication cable the gateway must have knowledge of the new controller. This is obtained by pushing the key PIN. The LED "Status" will flash when the gateway sends an acceptance message.

Operation

The configuration operation of the controller must take place from the software programme "Service Tool". The program must be installed on a PC, and the PC must be connected to the controller via the network plug on the front of the unit.

Light-emitting diodes

There are two rows with LED's. They mean:

Left row:

- Voltage supply to the controller
- Communication active with the bottom PC board (red = error)
- Status of outputs DO1 to DO8

Right row:

- Software status (slow flash = OK)
- Communication with Service Tool
- Communication on LON
- Alarm when LED flashes
- 3 LED's that are not used
- "Service Pin" switch has been activated

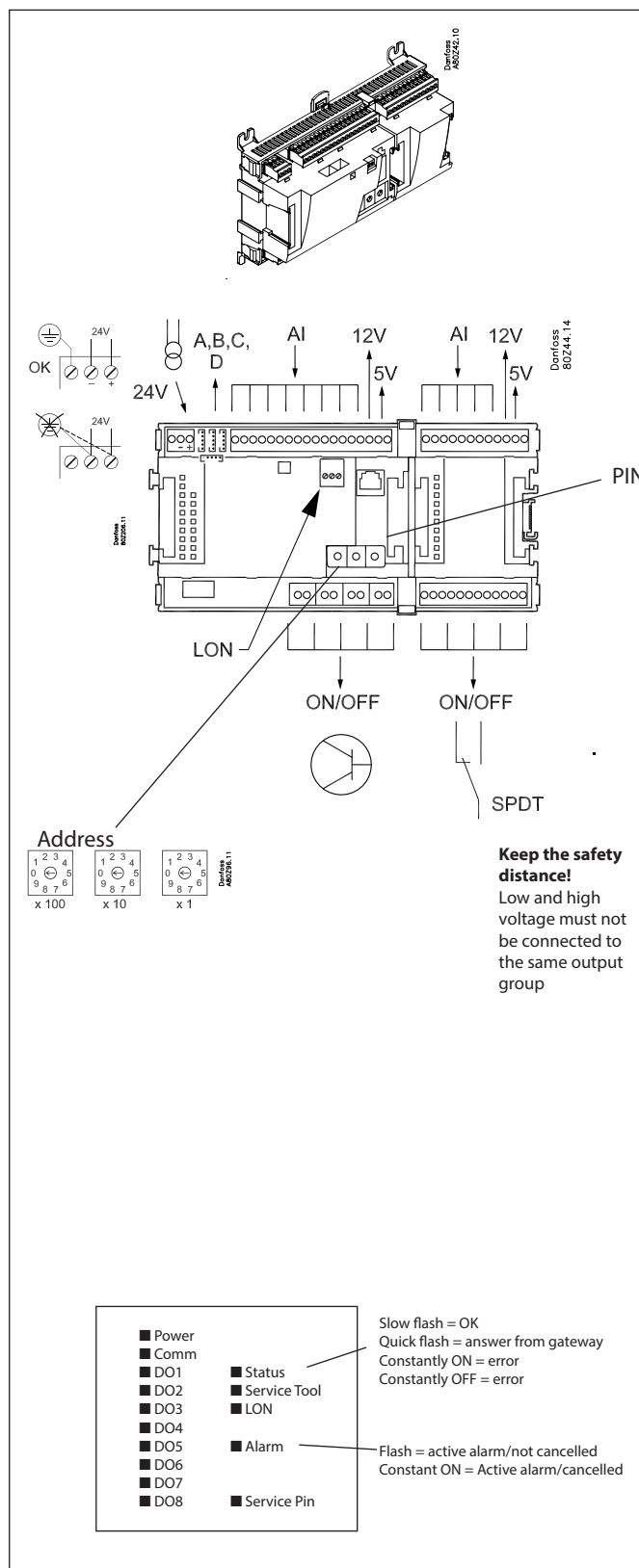

A small module (option board) can be placed on the bottom part of the controller. The module is described later in the document.

Point

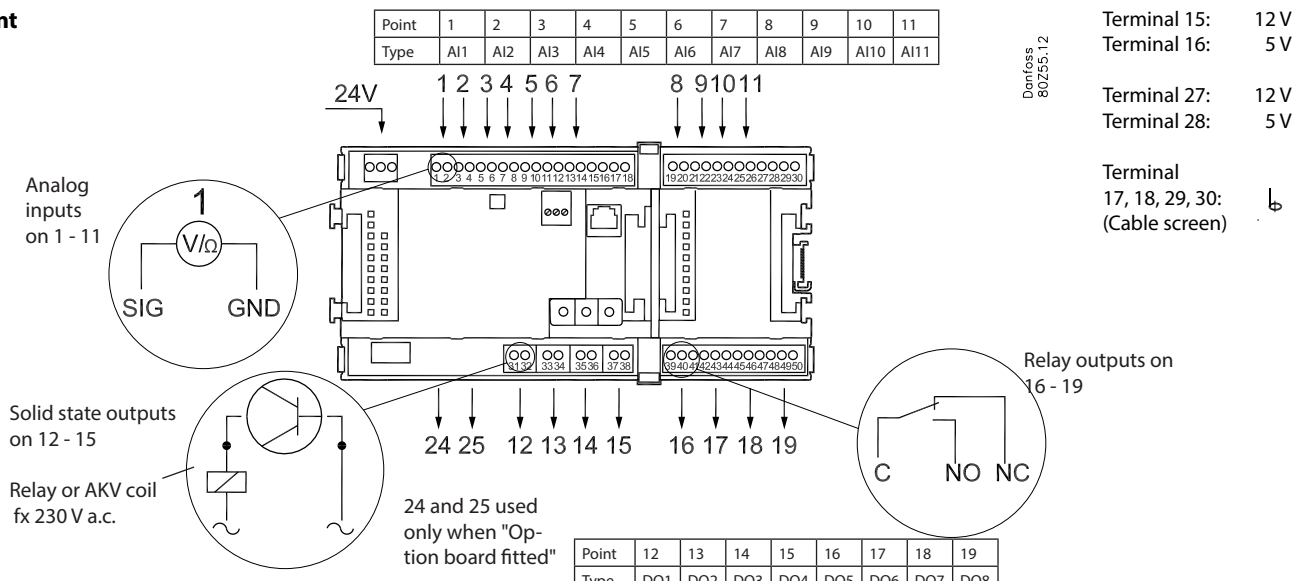

	Signal	Signal type
S Pt 1000 ohm/0°C	S1 S2 Saux1 SSA SdA	Pt 1000
P AKS 32R AKS 32	3: Brown SIG 2: Blue GND 1: Black 5V 3: Brown SIG 2: Black GND 1: Red 12V	POA POB PcA PcB AKS 32R / AKS 2050 / MBS 8250 -1 -xx bar AKS 32 -1 -zz bar
U	+	0 - 5V 0 - 10V
On/Off	Ext. Main switch Day/Night Door	Active at: Closed / Open
DO	AKV Comp 1 Comp 2 Fan 1 Alarm Light Rail heat Defrost	Active at: On / Off
Option Board	Please see the signal on the page with the module.	

Signal	Module	Point	Terminal	Signal type / Active at
	1	1 (AI 1)	1 - 2	
		2 (AI 2)	3 - 4	
		3 (AI 3)	5 - 6	
		4 (AI 4)	7 - 8	
		5 (AI 5)	9 - 10	
		6 (AI 6)	11 - 12	
		7 (AI 7)	13 - 14	
		8 (AI 8)	19 - 20	
		9 (AI 9)	21 - 22	
		10 (AI 10)	23 - 24	
		11 (AI 11)	25 - 26	
		12 (DO 1)	31 - 32	
		13 (DO 2)	33 - 34	
		14 (DO 3)	35 - 36	
		15 (DO 4)	37 - 38	
		16 (DO 5)	39 - 40 - 41	
		17 (DO 6)	42 - 43 - 44	
		18 (DO 7)	45 - 46 - 47	
		19 (DO 8)	48 - 49 - 50	
		24	-	
		25	-	

Extension module AK-XM 101A

Function

The module contains 8 analog inputs for sensors, pressure transmitters, voltage signals and contact signals.

Supply voltage

The supply voltage to the module comes from the previous module in the row.

Supply voltage to a pressure transmitter can be taken from either the 5 V output or the 12 V output depending on transmitter type.

Light-emitting diodes

Only the two top LED's are used. They indicate the following:

- Voltage supply to the module
- Communication with the controller is active (red = error)

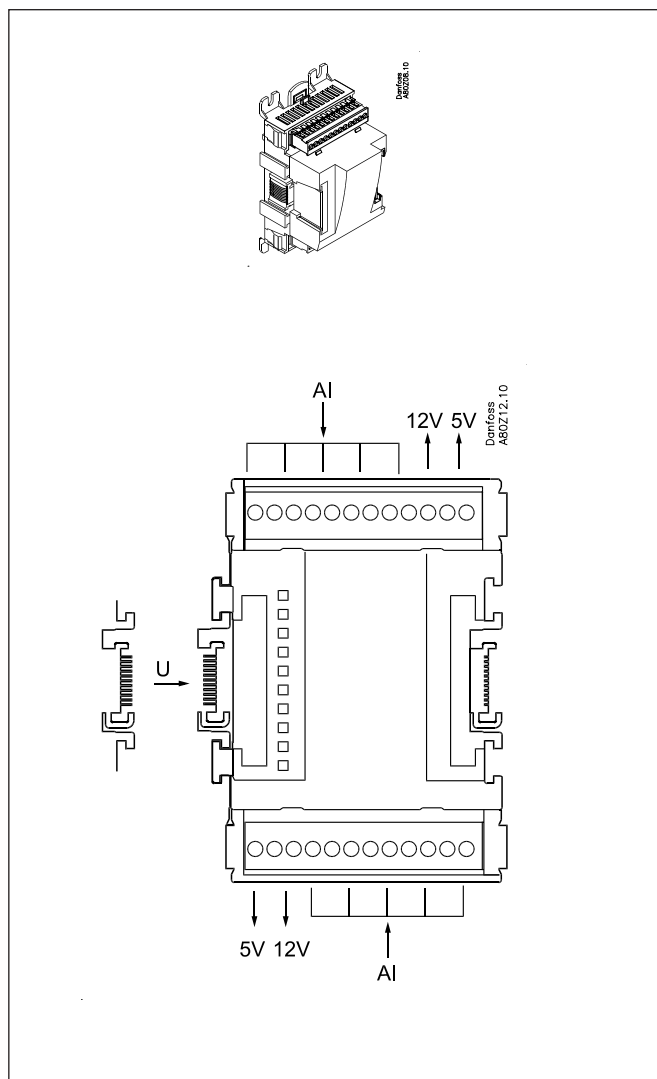

Point

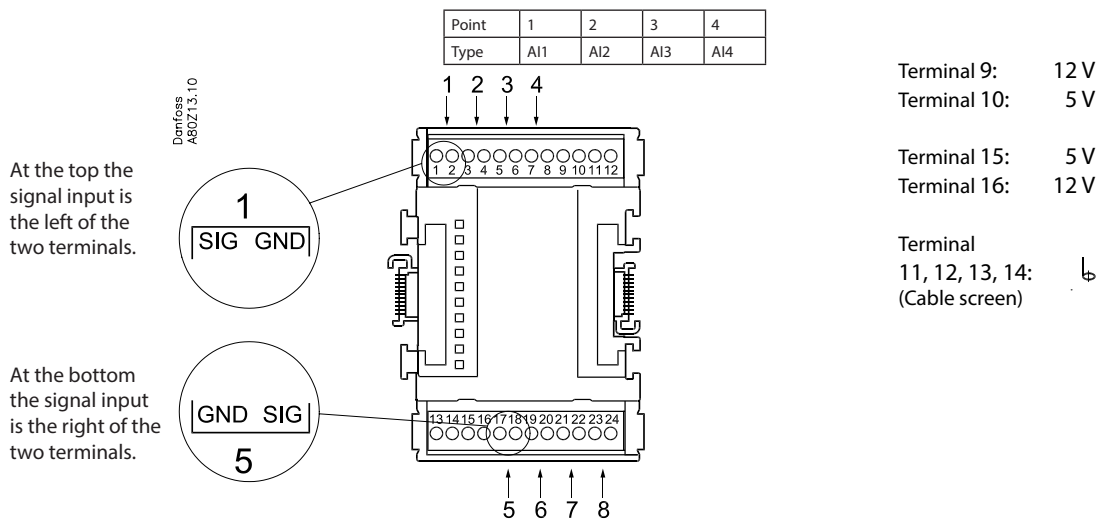

	Signal	Signal type
S Pt 1000 ohm/0°C 	S1 S2 Saux1 Saux2 SSA SdA	Pt 1000
P AKS 32R AKS 32 	POA POB PcA PcB	AKS 32R / AKS 2050 / MBS 8250 -1 - xx bar AKS 32 -1 - zz bar
U 	...	0 - 5 V 0 - 10 V
On/Off 	Ext. Main switch Day/Night Door	Active at: Closed / Open

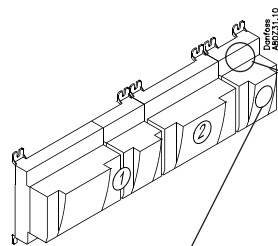

Signal	Module	Point	Terminal	Signal type / Active at
		1 (AI 1)	1 - 2	
		2 (AI 2)	3 - 4	
		3 (AI 3)	5 - 6	
		4 (AI 4)	7 - 8	
		5 (AI 5)	17 - 18	
		6 (AI 6)	19 - 20	
		7 (AI 7)	21 - 22	
		8 (AI 8)	23 - 24	

Extension module AK-XM 102A / AK-XM 102B

Function

The module contains 8 inputs for on/off voltage signals.

Signal

AK-XM 102A is for low voltage signals.

AK-XM 102B is for high voltage signals.

Supply voltage

The supply voltage to the module comes from the previous module in the row.

Light-emitting diodes

They indicate:

- Voltage supply to the module
- Communication with the controller is active (red = error)
- Status of the individual inputs 1 to 8 (when lit = voltage)

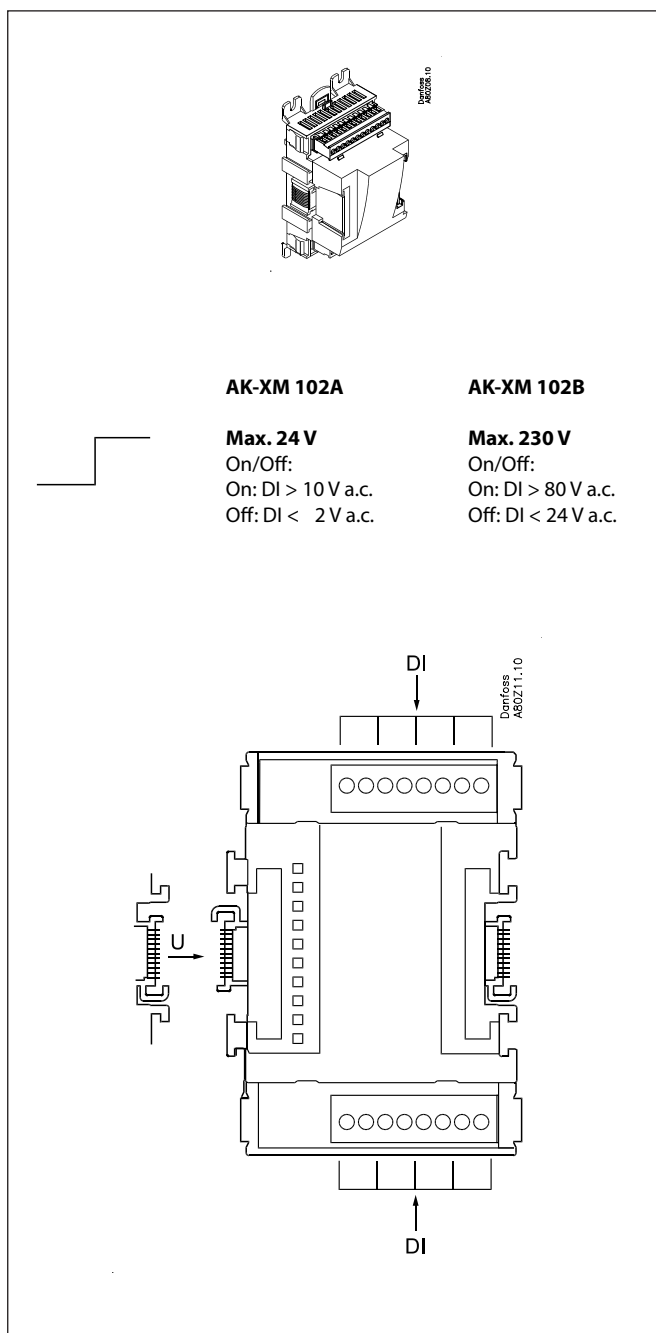

Point

Point	1	2	3	4
Type	DI1	DI2	DI3	DI4

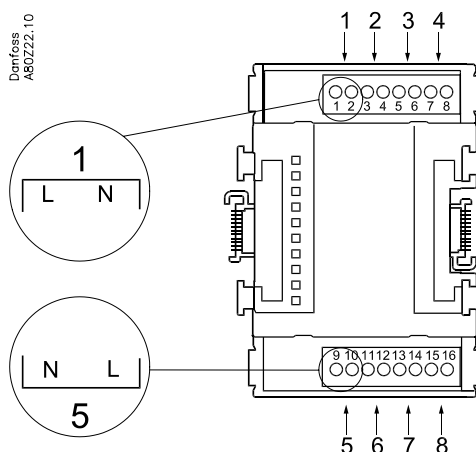

Point	5	6	7	8
Type	DI5	DI6	DI7	DI8

	Signal	Active at
DI	<p>AK-XM 102A: Max. 24 V AK-XM 102B: Max. 230 V</p>	<p>Ext. Main switch</p> <p>Day/ Night</p> <p>Comp. safety 1</p> <p>Comp. safety 2</p> <p>Closed (voltage on)</p> <p>/</p> <p>Open (voltage off)</p>

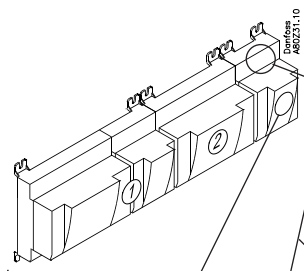

Signal	Module	Point	Terminal	Active at
		1 (DI 1)	1 - 2	
		2 (DI 2)	3 - 4	
		3 (DI 3)	5 - 6	
		4 (DI 4)	7 - 8	
		5 (DI 5)	9 - 10	
		6 (DI 6)	11 - 12	
		7 (DI 7)	13 - 14	
		8 (DI 8)	15 - 16	

Extension module AK-XM 103A

Function

The module contains :

4 analog inputs for sensors, pressure transmitters, voltage signals and contact signals.

4 analog voltage outputs of 0 - 10 V

Supply voltage

The supply voltage to the module comes from the previous module in the row.

Supply voltage to a pressure transmitter can be taken from either the 5 V output or the 12 V output depending on transmitter type.

Galvanic isolation

The inputs are galvanically separated from the outlets.

The outlets AO1 and AO2 are galvanically separated from AO3 and AO4.

Light-emitting diodes

Only the two top LED's are used. They indicate the following:

- Voltage supply to the module
- Communication with the controller is active (red = error)

Max. load

$I < 2.5 \text{ mA}$

$R > 4 \text{ k}\Omega$

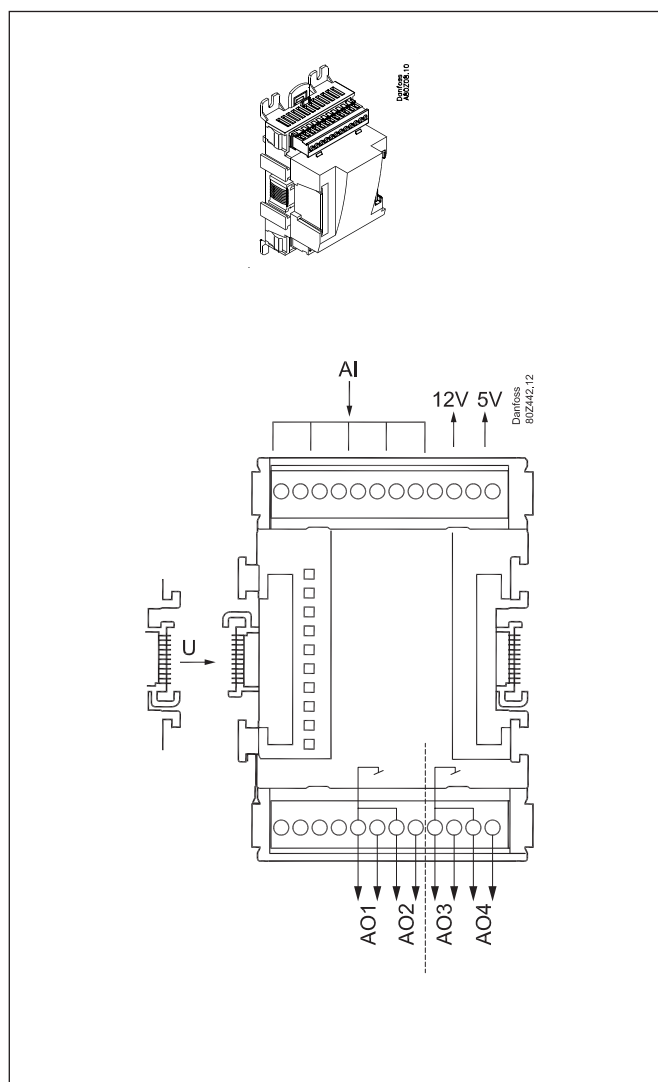

Point

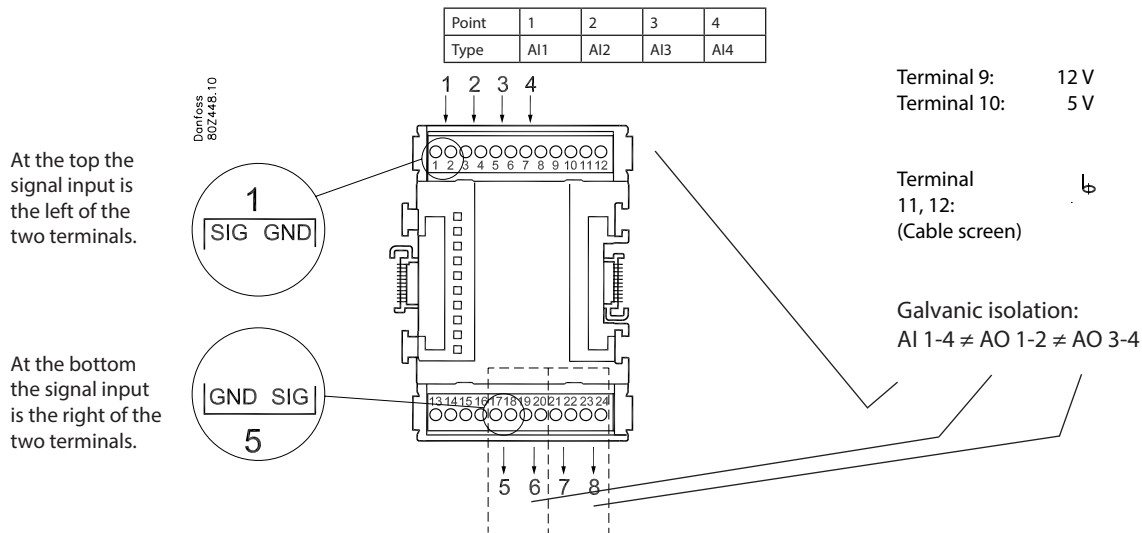

	Signal	Signal type
S Pt 1000 ohm/0°C 	S1 S2 Saux SsA SdA Shr Stw Sgc	Pt 1000
P AKS 32R AKS 32 	POA POB PcA PcB Paux Pgc Prec	AKS 32R / AKS 2050 MBS 8250 -1 - xx bar AKS 32 -1 - zz bar
U 	...	0 - 5 V 0 - 10 V
On/Off 	Ext. Main switch Day/ Night Door Level switch	Active at: Closed / Open
AO 		0-10 V

Point	5	6	7	8
Type	AO1	AO2	AO3	AO4

Signal	Module	Point	Terminal	Signal type /Active at
		1 (AI 1)	1 - 2	
		2 (AI 2)	3 - 4	
		3 (AI 3)	5 - 6	
		4 (AI 4)	7 - 8	
		5 (AO 1)	17 - 18	
		6 (AO 2)	19 - 20	
		7 (AO 3)	21 - 22	
		8 (AO 4)	23 - 24	

Extension module AK-XM 204A / AK-XM 204B

Function

The module contains 8 relay outputs.

Supply voltage

The supply voltage to the module comes from the previous module in the row.

AK-XM 204B only

Override of relay

Eight change-over switches at the front make it possible to override the relay's function.

Either to position OFF or ON.

In position Auto the controller carries out the control.

Light-emitting diodes

There are two rows with LED's. They indicate the following:

Left row:

- Voltage supply to the controller
- Communication active with the bottom PC board (red = error)
- Status of outputs DO1 to DO8

Right row: (AK-XM 204B only):

- Override of relays
 - ON = override
 - OFF = no override

Fuses

Behind the upper part there is a fuse for each output.

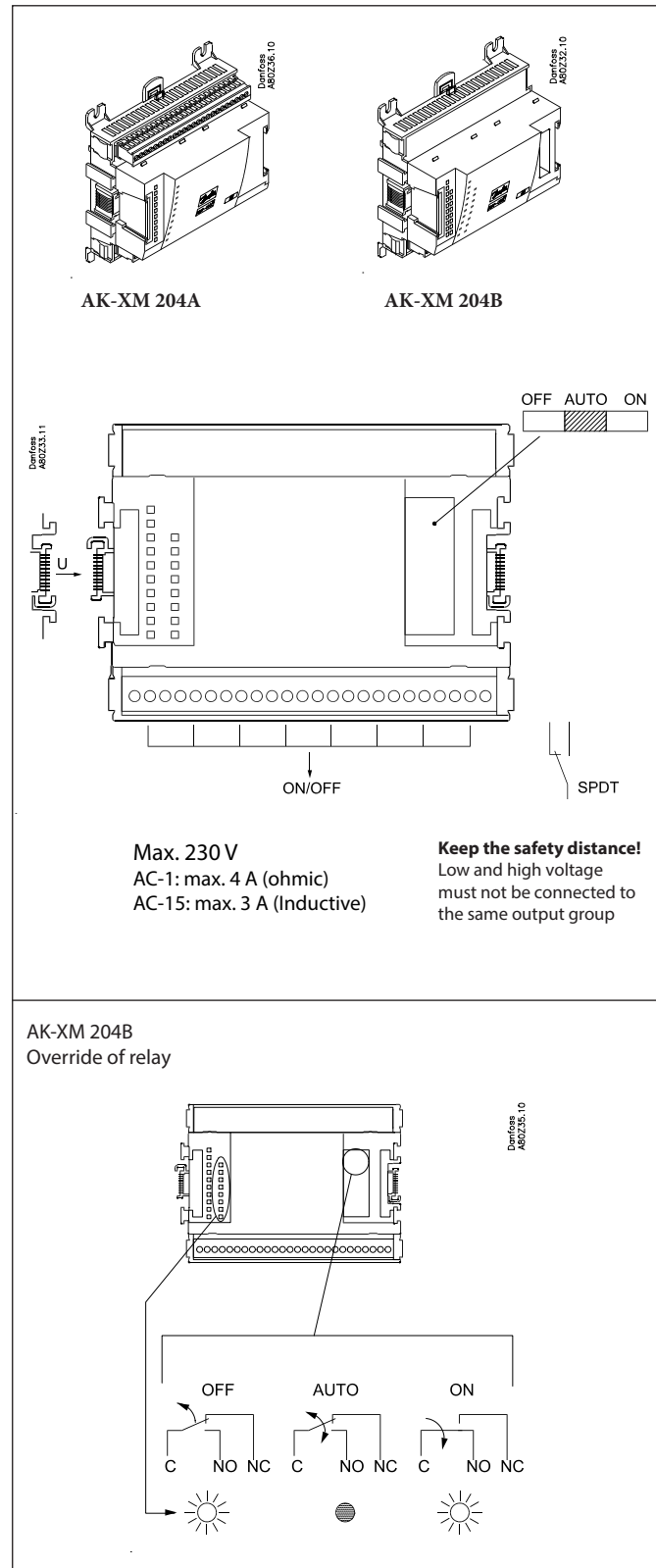

Point

Danfoss
A8C234.10

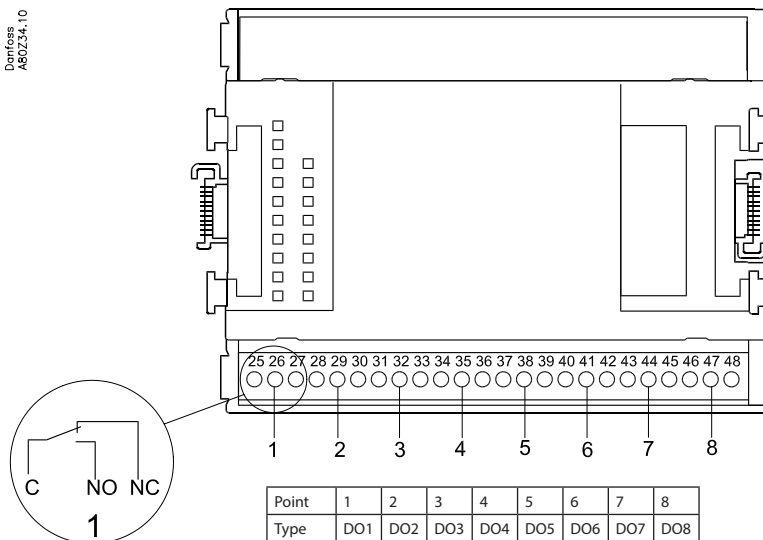

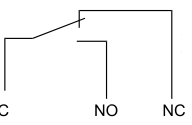
	Signal	Active at
	Comp. 1	On / Off
	Comp. 2	On / Off
	Fan 1	On / Off
	Alarm	On / Off

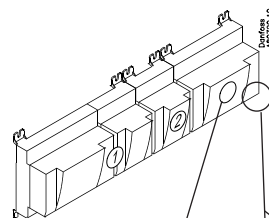

Signal	Module	Point	Terminal	Active at
		1 (DO 1)	25 - 26 - 27	
		2 (DO 2)	28 - 27 - 30	
		3 (DO 3)	31 - 32 - 33	
		4 (DO 4)	34 - 35 - 36	
		5 (DO 5)	37 - 38 - 39	
		6 (DO 6)	40 - 41 - 42	
		7 (DO 7)	43 - 44 - 45	
		8 (DO 8)	46 - 47 - 48	

Extension module AK-XM 205A / AK-XM 205B

Function

The module contains:
 8 analog inputs for sensors, pressure transmitters, voltage signals
 and contact signals.
 8 relay outputs.

Supply voltage

The supply voltage to the module comes from the previous module in the row.

AK-XM 205B only

Override of relay

Eight change-over switches at the front make it possible to override the relay's function. Either to position OFF or ON. In position Auto the controller carries out the control.

Light-emitting diodes

There are two rows with LED's. They mean:

Left row:

- Voltage supply to the controller
- Communication active with the bottom PC board (red = error)
- Status of outputs DO1 to DO8

Right row: (AK-XM 205B only):

- Override of relays
- ON = override
- OFF = no override

Fuses

Behind the upper part there is a fuse for each output.

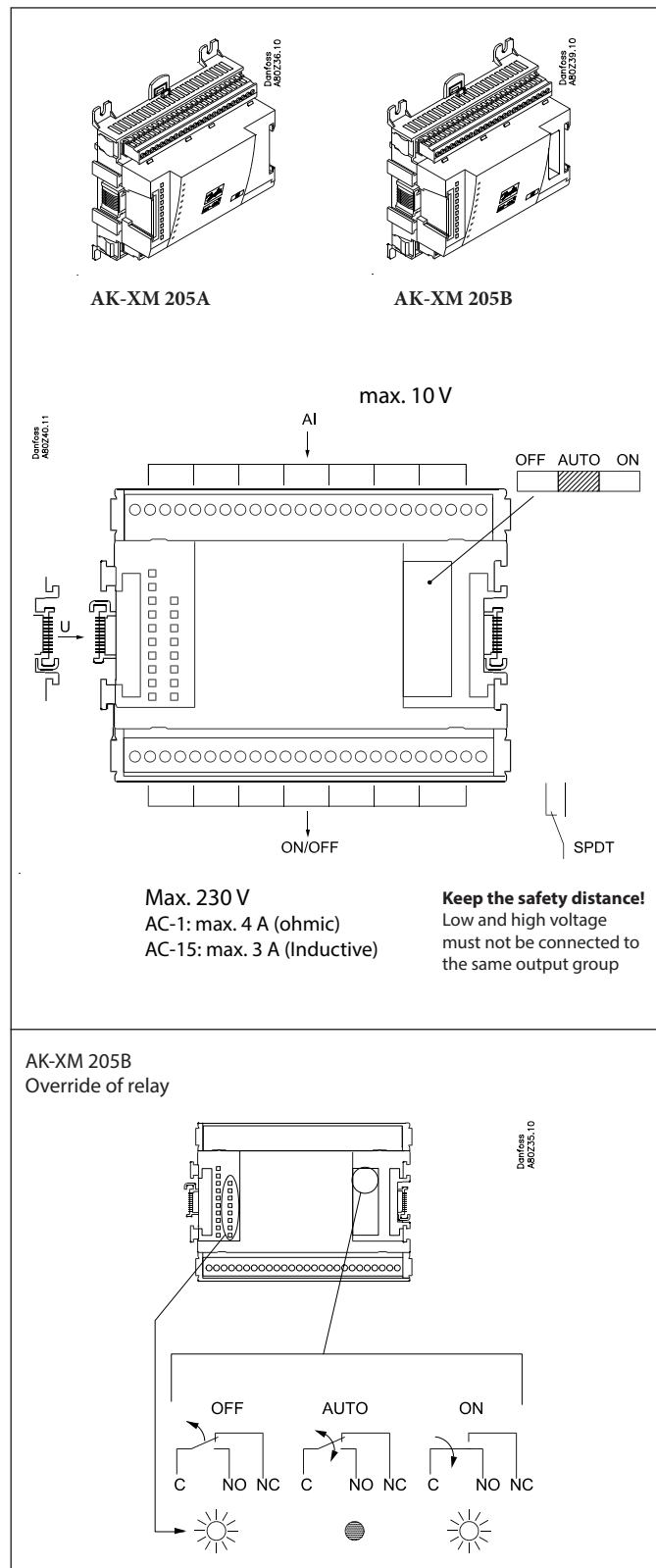

Point

Point	1	2	3	4	5	6	7	8
Type	AI1	AI2	AI3	AI4	AI5	AI6	AI7	AI8

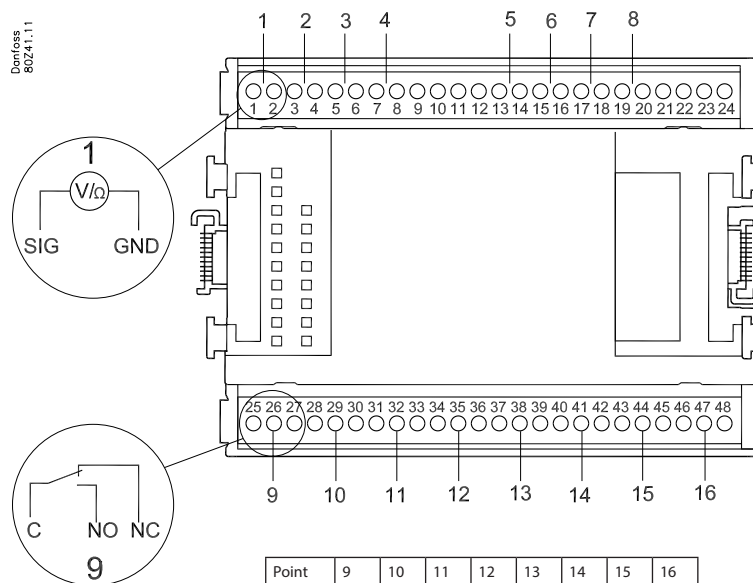

Terminal 9: 12V
Terminal 10: 5V

Terminal 21: 12V
Terminal 22: 5V

Terminal 11, 12, 23, 24: 6 (Cable screen)

Point	9	10	11	12	13	14	15	16
Type	DO1	DO2	DO3	DO4	DO5	DO6	DO7	DO8

	Signal	Signal type
S Pt 1000 ohm/0°C 	S1 S2 Saux1 Saux2 SSA SdA	Pt 1000
P AKS 32R AKS 32 	POA POB PcA PcB	AKS 32R / AKS 2050 / MBS 8250 -1 -xx bar AKS 32 -1 -zz bar
U 	...	0 - 5 V 0 - 10 V
On/Off 	Ext. Main switch Day/Night Door	Active at: Closed / Open
DO 	Comp 1 Comp 2 Fan 1 Alarm Light Rail heat Defrost	Active at: on / Off

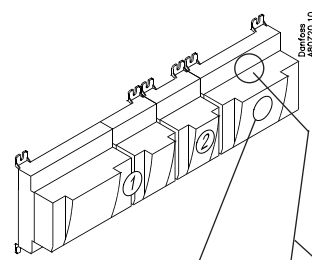

Signal	Module	Point	Terminal	Signal type / Active at
		1 (AI 1)	1 - 2	
		2 (AI 2)	3 - 4	
		3 (AI 3)	5 - 6	
		4 (AI 4)	7 - 8	
		5 (AI 5)	13 - 14	
		6 (AI 6)	15 - 16	
		7 (AI 7)	17 - 18	
		8 (AI 8)	19 - 20	
		9 (DO 1)	25 - 26 - 27	
		10 (DO 2)	28 - 29 - 30	
		11 (DO 3)	31 - 32 - 33	
		12 (DO 4)	34 - 35 - 36	
		13 (DO 5)	37 - 38 - 39	
		14 (DO6)	40 - 41 - 42	
		15 (DO7)	43 - 44 - 45	
		16 (DO8)	46 - 47 - 48	

Extension module AK-OB 110

Function

The module contains two analog voltage outputs of 0 – 10 V.

Supply voltage

The supply voltage to the module comes from the controller module.

Placing

The module is placed on the PC board in the controller module.

Point

The two outputs have points 24 and 25. They are shown on the earlier page where the controller is also mentioned.

Max. load

$I < 2,5 \text{ mA}$

$R > 4 \text{ kohm}$

AO	-	→	0-10 V	AO	0 - 10 V
	+	→			

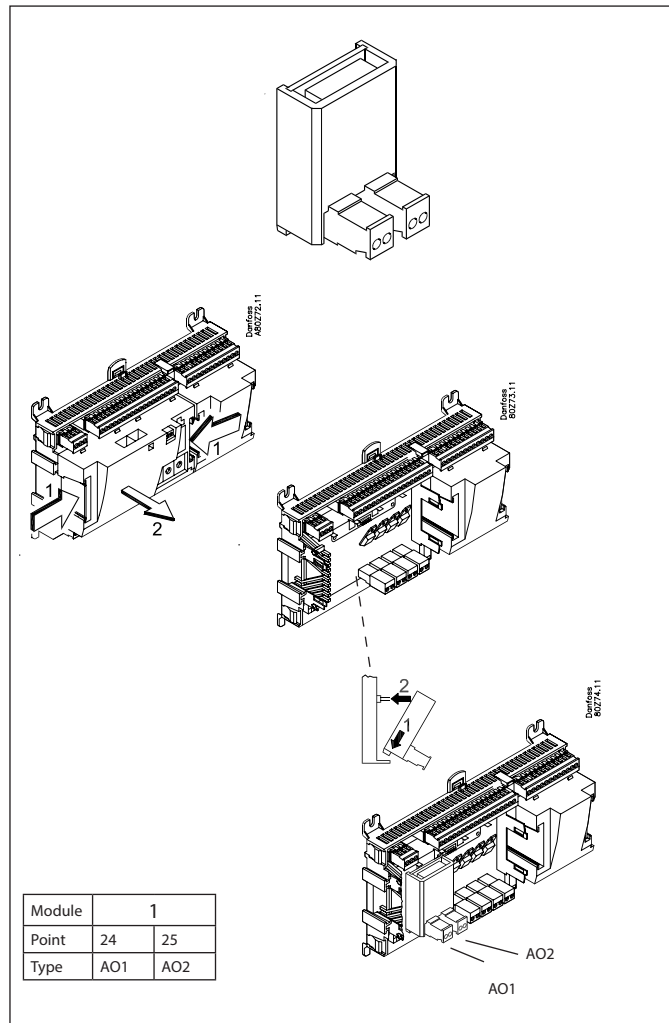

Module	1	
Point	24	25
Type	AO1	AO2

Extension module AK-OB 101A

Function

The module is a real time clock module with battery backup.

The module can be used in controllers that are not linked up in a data communication unit together with other controllers. The module is used here if the controller needs battery backup for the following functions

- Clock function
- Fixed times for day/night change-over
- Fixed defrost times
- Saving of alarm log in case of power failure
- Saving of temperature log in case of power failure

Connection

The module is provided with plug connection.

Placing

The module is placed on the PC board inside the top part.

Point

No point for a clock module to be defined – just connect it.

Working life of the battery

The working life of the battery is several years – even if there are frequent power failures.

An alarm is generated when the battery has to be replaced.

After the alarm there are still several months of operating hours left in the battery.

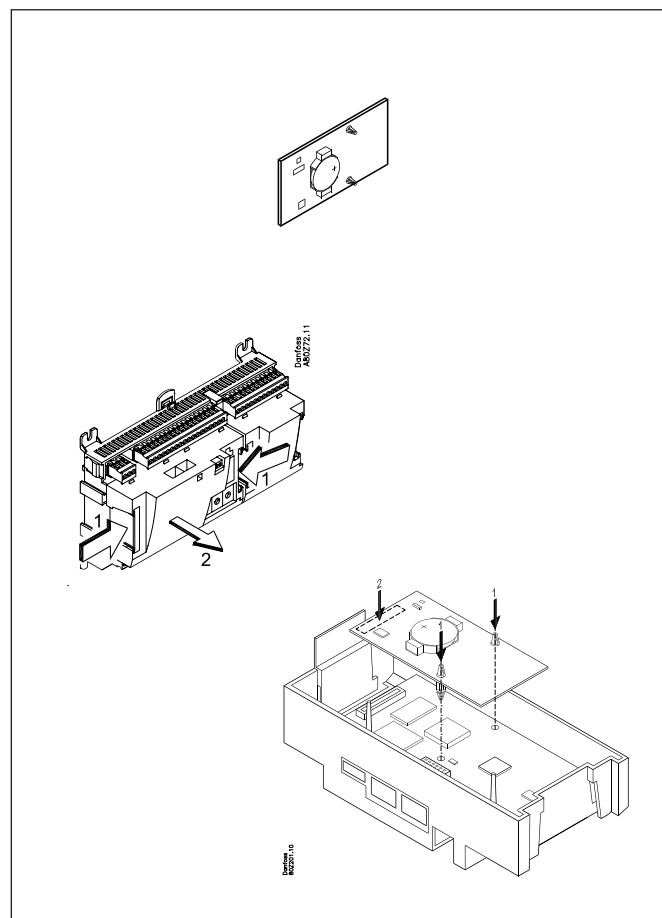

Extension module EKA 163B / EKA 164B

Function

Display of important measurements from the controller, e.g. appliance temperature, suction pressure or condensing pressure. Setting of the individual functions can be performed by using the display with control buttons. It is the controller used that determines the measurements and settings that can occur.

Connection

The extension module is connected to the controller module via a cable with plug connections. You have to use one cable per module. The cable is supplied in various lengths.

Both types of display (with or without control buttons) can be connected to either display output A, B, C or D.

When the controller starts up, the display will show the output that is connected.

- 1 = output A
- 2 = output B
- etc.

Placing

The extension module can be placed at a distance of up to 15 m from the controller module.

Point

No point has to be defined for a display module – you simply connect it.

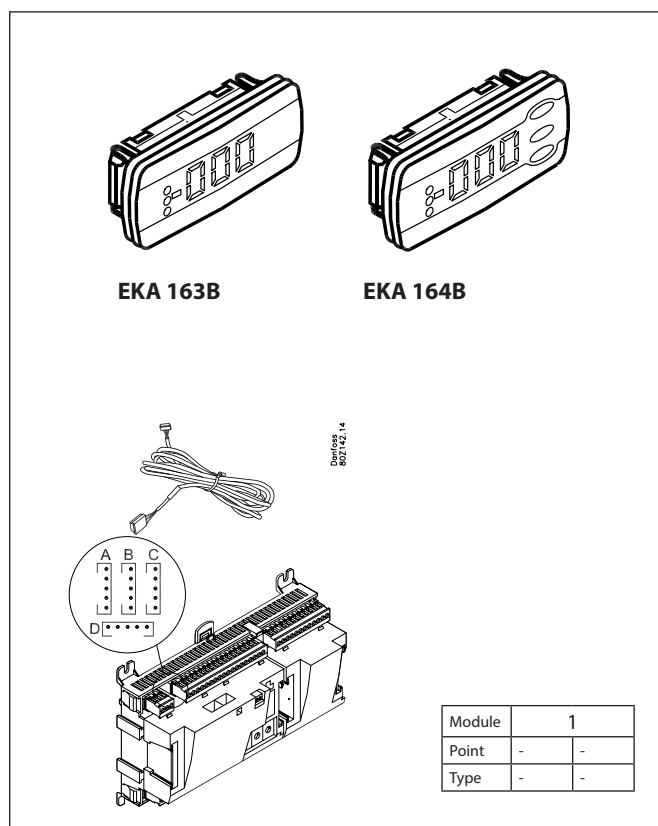

Power supply module AK-PS 075 / 150

Function

24 V supply for controller.

Supply voltage

230 V a.c or 115 V a.c. (from 100 V a.c. to 240 V a.c.)

Placing

On DIN-rail

Effect

Type	Output tension	Output current	Power
AK-PS 075	24 V d.c.	0.75 A	18 VA
AK-PS 150	24 V d.c. (adjustable)	1.5 A	36 VA

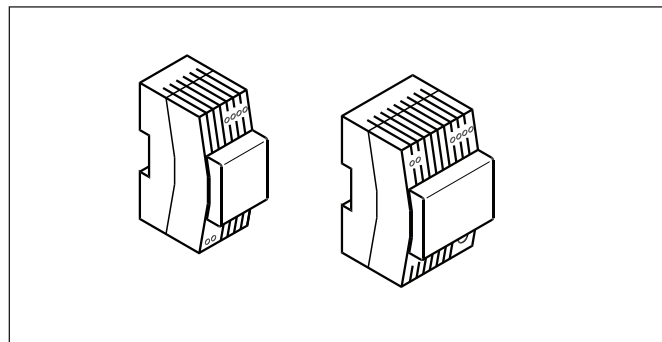

Dimension

Type	High	Width
AK-PS 075	90 mm	36 mm
AK-PS 150	90 mm	54 mm

Connections

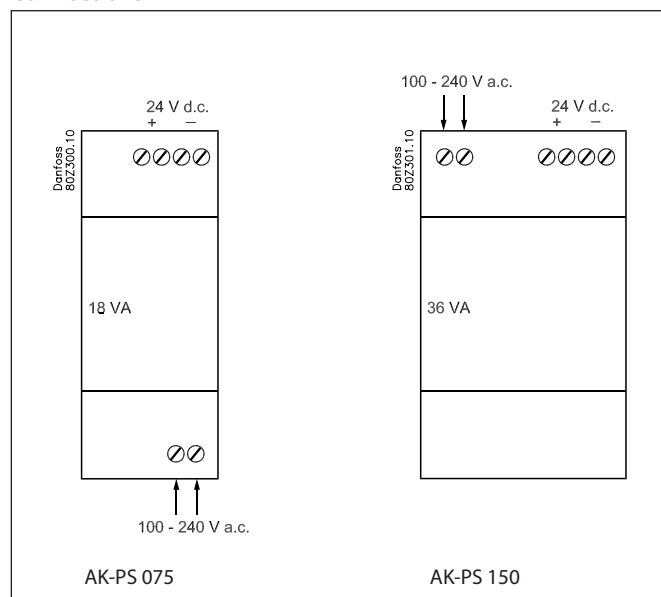

Supply to a controller

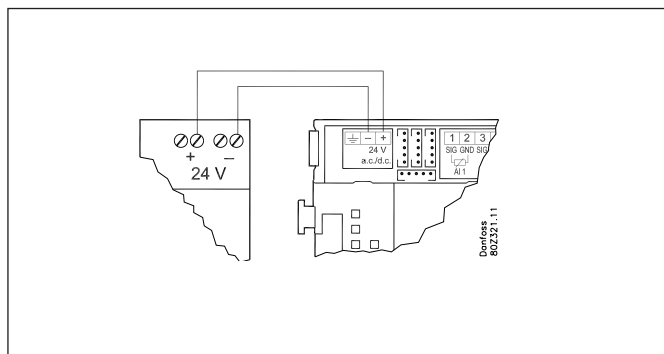

Preface to design

Be aware of the following when the number of extension modules is being planned. A signal may have to be changed, so that an additional module may be avoided.

- An ON/OFF signal can be received in two ways. Either as a contact signal on an analog input or as voltage on a low or high-voltage module.
- An ON/OFF output signal can be given in two ways. Either with a relay switch or with solid state. The primary difference is the permitted load and that the relay switch contains a cutout switch.

Mentioned below is a number of functions and connections that may have to be considered when a regulation has to be planned. There are more functions in the controller than the ones mentioned here, but those mentioned have been included in order that the need for connections can be established.

Functions

Clock function

Clock function and change-over between summer time and winter time are contained in the controller.

The clock is zeroset when there is power failure.

The clock's setting is maintained if the controller is linked up in a network with a gateway, or a clock module can be mounted in the controller.

Start/stop of regulation

Regulation can be started and stopped via the software. External start/stop can also be connected.

Alarm function

If the alarm is to be sent to a signal transmitter, a relay output will have to be used.

Extra temperature sensors and pressure sensors

If additional measurements have to be carried out beyond the regulation, sensors can be connected to the analog inputs.

Forced control

The software contains a forced control option. If an extension module with relay outputs is used, the module's top part can be with change-over switches – switches that can override the individual relays into either OFF or ON position.

Data communication

The controller module has terminals for LON data communication. The requirements to the installation are described in a separate document.

Connections

In principle there are the following types of connections:

Analog inputs "AI"

This signal must be connected to two terminals. Signals can be received from the following sources:

- Temperature signal from Pt 1000 ohm temperature sensor
- Contact signal where the input is short-circuited or "opened", respectively
- Voltage signal from 0 to 10 V
- Signal from pressure transmitter AKS 32, AKS 32R or AKS 2050

The supply voltage is supplied from the module's terminal board where there is both a 5 V supply and a 12 V supply. When programming the pressure transmitter's pressure range must be set.

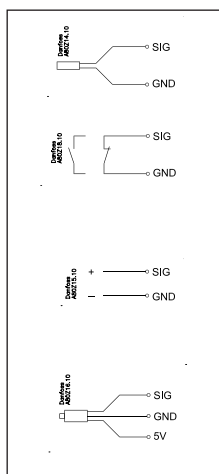

ON/OFF output signals "DO"

There are two types, as follows:

- Relay outputs
All relay outputs are with change-over relay so that the required function can be obtained when the controller is without voltage.
- Solid state outputs
Reserved for AKV valves, but output can cut an external relay in and out, as with a relay output.
The output is only found on the controller module.

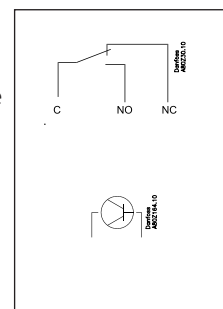

When programming the function must be set:

- Active when the output is activated
- Active when the output is not activated.

ON/OFF voltage inputs "DI"

This signal must be connected to two terminals.

- The signal must have two levels, either 0 V or "voltage" on the input.
There are two different extension modules for this signal type:
 - low-voltage signals, e.g. 24 V
 - high-voltage signals, e.g. 230 V

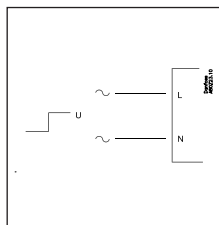

Analog output signal "AO"

This signal is to be used if a control signal is to be transmitted to an external unit, e.g. a frequency converter.

When programming the signal range must be defined: 0-5 V, 1-5 V, 0-10 V or 2-10 V.

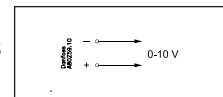

When programming the function must be set:

- Active when the input is without voltage
- Active when voltage is applied to the input.

Limitations

As the system is very flexible regarding the number of connected units you must check whether your selection complies with the few limitations there are.

The complexity of the controller is determined by the software, the size of the processor, and the size of the memory. It provides the controller with a certain number of connections from which data can be downloaded, and others where coupling with relays can be performed.

- ✓ The sum of connections cannot exceed **80**.
- ✓ The number of extension modules must be limited so that the total power will not exceed **32 VA** (including controller).
- ✓ No more than **5** pressure transmitters may be connected to one controller module.
- ✓ No more than **5** pressure transmitters may be connected to one extension module.

Common pressure transmitter

If several controllers receive a signal from the same pressure transmitter, the supply to the affected controllers must be wired so that it is not possible to switch off one of the controllers without also switching off the others. (If one controller is switched off, the signal will be pulled down, and all the other controllers will receive a signal which is too low)

Design of a compressor and condenser control

Procedure:

1. Make a sketch of the system in question
2. Check that the controller's functions cover the required application
3. Consider the connections to be made
4. Use the planning table. / Note down the number of connections / add up
5. Are there enough connections on the controller module? – If not, can they be obtained by changing an ON/OFF input signal from voltage signal to contact signal, or will an extension module be required?
6. Decide which extension modules are to be used
7. Check that the limitations are observed
8. Calculate the total length of modules
8. The modules are linked together
10. The connection sites are established
11. Draw a connection diagram or a key diagram
12. Size of supply voltage/transformer

Follow these 12 steps



1

Sketch

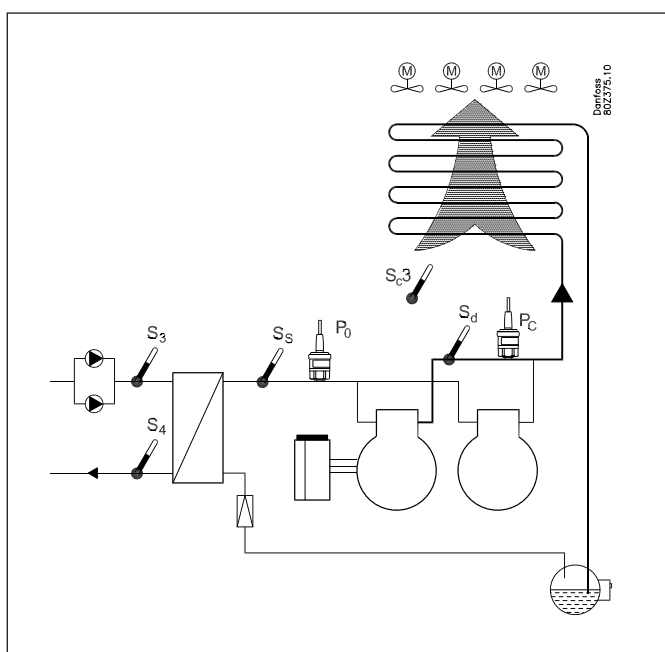

Make a sketch of the actual plant.

2

Compressor and condenser functions

	AK-CH 650
Application	
Regulation of a compressor group	x
Regulation of a condenser group	x
Both compressor group and condenser group	x
Pumpe control	x
Regulation of compressor capacity	
PI-regulation	x
Max. number of compressors	6
Max. number of unloaders each compressor	3
Identical compressor capacities	x
Different compressor capacities	x
Sequentiel operation (first in / last out)	x
Speed regulation of 1 or 2 compressors	x
Run time equalisation	x
Min. restart time	x
Min. On-time	x
Liquid injection in heat exchanger	x
Liquid injection in suction line	x
Load shedding (Capacity limitation)	x
Relay output, which is activated by a request for extra cooling	x
0-10 V signal, which shows cutin compressor capacity	x
Brine temperature reference	
Override via P0 optimisation	x
Override via "night setback"	x
Override via "0-10 V signal"	x
Regulation of condenser capacity	
Step regulation	x

Max. number of steps	8
Speed regulation	x
Step and speed regulation	x
Speed regulation on first step	x
Limitation of speed during night operation	x
Heat recovery function via thermostat function	x
Heat recovery function via DI signal	x
Trouble-shooting function FDD on condenser	x
Condenser pressure reference	
Floating condensing pressure reference	x
Setting of reference for heat recovery function	x
Safety functions	
Min. suction pressure	x
Max. suction pressure	x
Max. condensing pressure	x
Max. discharge gas temperature	x
Min. / Max. superheat	x
Safety monitoring of compressors	x
Common high pressure monitoring of compressors	x
Safety monitoring of condenser fans	x
General alarm functions with time delay	10
Frost protection	x
Miscellaneous	
Extra sensors	7
Option for connection of separate display	2
Separate thermostat functions	5
Separate pressostat functions	5
Separate voltage measurements	5

A bit more about the functions

Compressor

Regulation of up to 6 compressors. Up to three unloaders per compressor. Compressor No. 1 or 2 can be speed-regulated.

Condenser

Regulation of up to 8 condenser steps.

Fans can be speed-regulated. Either all on one signal or only the first fan of several.

Relay outputs and solid state outputs may be used, as desired.

Speed regulation of condenser fans

The function requires an analog output module.

A relay output may be used for start/stop of the speed regulation.

The fans may also be cut in and out by relay outputs.

Safety circuit

If signals are to be received from one or more parts of a safety circuit, each signal must be connected to an ON/OFF input.

Day/night signal for raising the suction pressure

The clock function can be used, but an external ON/OFF signal may be used instead.

If the "PO optimisation" function is used, no signal will be given concerning the raising of the suction pressure. The PO optimisation will see to this.

Separate thermostat and pressure control functions

A number of thermostats can be used according to your wishes.

The function requires a sensor signal and a relay output. In the controller there are settings for cutin and cutout values. An associated alarm function may also be used.

Separate voltage measurements

A number of voltage measurements can be used according to your wishes. The signal can for example be 0-10 V. The function requires a voltage signal and a relay output. In the controller there are settings for cutin and cutout values. An associated alarm function may also be used.

If you want to know more about the functions, go to chapter 5.

3 Connections

Here is a survey of the possible connections. The texts can be read in context with the table in point 4.

Analog inputs

Temperature sensors

- S4 and S3 (brine temperature)
Must always be used in connection with compressor regulation.
- Ss (suction gas temperature)
Must always be used in connection with compressor regulation.
- Sd (discharge gas temperature)
Must always be used in connection with compressor regulation.
- Sc3 (outdoor temperature)
To be used when monitoring function FDD is used.
To be used when regulation is performed with floating condenser reference.
- S7 (Hot brine return temperature)
This must be used when the control sensor for the condenser has been selected as S7.
- Saux (1-4), Extra temperature sensors, if applicable
Up to four additional sensors for monitoring and data collection may be connected.
These sensors can be used for general thermostat functions.
- Shrec (heat recovery thermostat)
Must be used when heat recovery is controlled via a thermostat function.

Pressure transmitters

- P0 Suction Pressure

Must always be used in connection with compressor regulation (frost protection)

- Pc Condensing Pressure

Must always be used in connection with compressor and condenser regulation

- Paux (1-3)

Up to 3 extra pressure transmitters can be connected for monitoring and data collection.

These sensors can be used for general pressure switch functions.

A pressure transmitter type AKS 32 or AKS 32R can supply signals to a maximum of five controllers.

Voltage signal

- Ext. reference

Used when overriding signal is received from another control.

- Volt inputs (1-5)

Up to 5 extra voltage signals can be connected for monitoring and data collection. These signals can be used for general voltage input functions.

On/Off-inputs

Contact function (on an analog input) or voltage signal (on an extension module)

- Frost protection
- Flow switch or pressure difference for pump monitoring
- Start of defrost
- Up to 6 signals from each compressors safety circuits
- Signal from the condenser fans' safety circuit
- Any signal from the frequency converter's safety circuit (comp. and/or fans)
- External start/stop of regulation

- External start stop of heat recovery

- Up to 2 Inputs for capacity limitation

- External day/night signal (raise/lower the suction pressure reference). The function is not used if the "P0 optimisation" function is used.

- DI alarm (1-10) inputs.

Up to 10 extra on/off signals for general alarm monitoring and data collection can be connected.

On/off-outputs

Relay outputs

- Compressors (1-6)

- Unloaders (max. 3/compressor)

- Request extra cooling capacity

- Fan motor (1-8)

- Start/stop of liquid injection in heat exchanger

- Defrost output

- Start/stop of liquid injection in suction line

- Start/stop of heat recovery

- Start/stop of twin pumps (1-2)

- Start/stop of speed control (1-2) (comp. / fans)

- Alarm relay

- General functions from thermostats (1-5), pressostats (1-5) and voltage inputs (1-5).

Solid state outputs

The solid state outputs on the controller module may be used for the same functions as those mentioned under "relay outputs". (The output will always be "OFF" when the controller has a power failure).

Analog output

- Speed regulation of the condenser's fans.

- Speed regulation of compressor.

- Signal cutin compressor capacity.

Example

Compressor groupe:

- Refrigerant R404A
- 1 only speed-regulated compressor (30 kW, 30-60 Hz)
- 3 only compressors (15 kW) with working-hour equalisation
- Safety monitoring of each compressor + frequency converter
- Capacity limitation of compressors via contact signal (load shedding)
- Injection signal to heat exchanger
- Frost protection input (230 V a.c.)
- S4 setting 2°C

Air cooled condenser:

- 4 fans, step regulation
- Pc regulates based on outdoor temperature sensor Sc3

Pumps + defrost:

- start/stop of 2 pumps
- Monitoring via flow switch (contact signal)
- Output for defrost

Receiver:

- Monitoring of liquid level (230 V a.c.)

Fan in plant room

- Thermostat control of fan in engine room (sensor + output)

Safety functions:

- Monitoring of P0, Pc, Sd and superheat in suction line
- P0 min. = -10°C
- Pc max. = 50°C
- Sd max. = 120°C
- SH min. = 5°C, SH max. = 35°C

Other:

- Alarm output used
- External main switch used (contact signal)

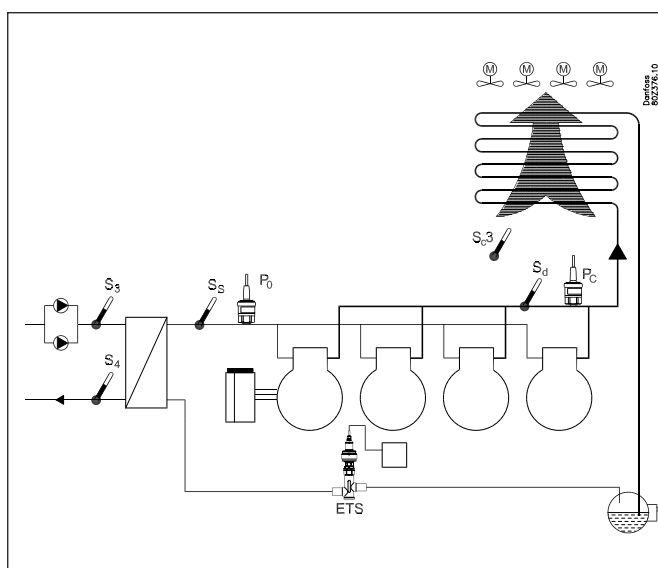

Data from this example is used on the next page.

The result is that the following modules should be used:

- AK-CH 650 basic module
- AK-XM 102A digital input module
- AK-XM 204B relay module
- AK-OB 110 analog output module

4

Planning table

The table helps you establish whether there are enough inputs and outputs on the basic controller. If there are not enough of them, the controller must be extended by one or more of the mentioned extension modules.

Note down the connections you will require and add them up

		Analog input signal		On/off voltage signal		On/off voltage signal		On/Off output signal		Analog output signal 0-10 V		7	
		Example	Example	Example	Example	Example	Example	Example	Example			Limitations	
Analog inputs													
	Temperature sensors, S3, S4, S7		2										
	Temperature sensors, Ss, Sd		2										
	Outdoor temperature sensor, Sc3		1										
	Extra temperature sensor / separate thermostats		1										
	Pressure transmitters, P0, Pc, separate pressostats		2										
	0-10V signal from other regulation, separate signals												
	Heat recovery via thermostat												
On/off inputs		contact		24 V		230 V							
	Safety circuits, frost protection												
	Safety circuits, Oil pressure												
	Safety circuits, comp. Motor protection /Motor temp.												
	Safety circuits, comp. High pres. thermostat												
	Safety circuits, comp. High pres. pressostat												
	Safety circuits, general for each compressor												
	Safety circuits, condenser fans												
	Safety circuits, frequency converter, comp. / cond.												
	Defrost start												
	External start/stop		1										
	Night setback of suction pressure												
	Flow switch												
	Separate alarm functions		1										
	Heat recovery via DI												
	Capacity limitations		1										
On/off outputs													
	Compressors (motors) (extra capacity)												
	Unloaders												
	Fan motors												
	Alarm relay												
	Pumps												
	Defrost output												
	Separate thermostat and pressostat functions and voltage measurements												
	Heat recovery function												
	Liquid injection in suction line and heat exchanger												
Analog control signal, 0-10 V													
	Frequency converter compressor / condenser												
	Signal cutin compressor capacity												
Sum of connections for the regulation			11		0		7		14		1		Sum = max. 80
	Number of connections on a controller module	11	11	0	0	0	0	8	8	0	0		
5	Missing connections, if applicable		-		-		7		6		1		
6	The missing connections to be supplied by one or more extension modules:											Sum of power	
	AK-XM 101A (8 analog inputs)												___ pcs. á 2 VA = ___
	AK-XM 102A (8 digital low voltage inputs)												___ pcs. á 2 VA = ___
	AK-XM 102B (8 digital high voltage outputs)						1						___ pcs. á 2 VA = ___
	AK-XM 103A (4 analog inputs 4 analog outputs)												___ pcs. á 2 VA = ___
	AK-XM 204A / B (8 relay outputs)								1				___ pcs. á 5 VA = ___
	AK-XM 205A / B (8 analog inputs + 8 relay outp.)												___ pcs. á 5 VA = ___
	AK_OB 110 (2 analog outputs)										1		___ pcs. á 0 VA = 0
													1 pcs. á 8 VA = 8
													Sum =
													Sum = max. 32 VA

The example: None of the 3 limitations are exceeded => OK

8 Length

If you use many extension modules the controller's length will grow accordingly. The row of modules is a complete unit which cannot be broken.

The module dimension is 72 mm.

Modules in the 100-series consist of one module

Modules in the 200-series consist of two modules

The controller consist of three modules

The length of an aggregate unit = $n \times 72 + 8$

or in an other way:

Module	Type	Number	at	Length
Controller module		1	x	224
Extension module	200-series	—	x	144
Extension module	100-series	—	x	72
Total length				= ___ mm

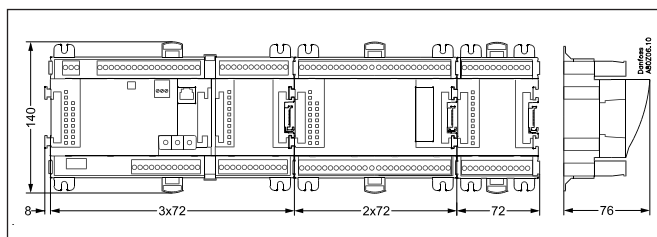

Example continued:
Controller module + 1 extension module in 200-series + 1 extension module in 100-series =
 $224 + 144 + 72 = 440$ mm.

9 Linking of modules

Start with the controller module and then mount the selected extension modules. The sequence is of no importance.

However, you must **not** change the sequence, i.e. rearrange the modules, after you have made the setup where the controller is told which connections are found on which modules and on which terminals.

The modules are attached to one another and kept together by a connection which at the same time transmits the supply voltage and the internal data communication to the next module.

Mounting and removal must always be performed when there is no voltage.

The protective cap mounted on the controller's plug connection must be moved to the last vacant plug connection so that the plug will be protected against short-circuit and dirt.

When the regulation has started the controller will all the time check whether there is connection to the connected modules. This status can be followed by the light-emitting diode.

When the two catches for the DIN rail mounting are in open position the module can be pushed into place on the DIN rail – no matter where in the row the module is found. Removal is likewise carried out with the two catches in the open position.

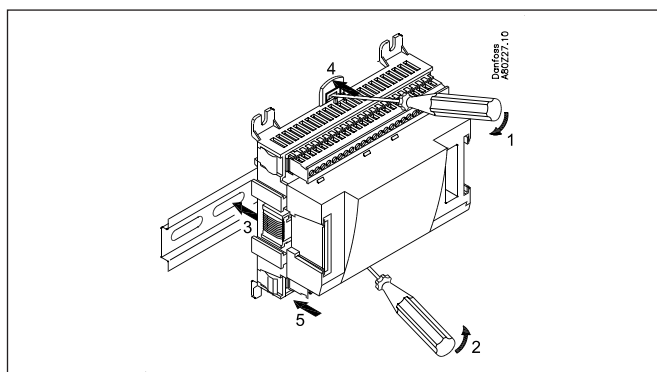
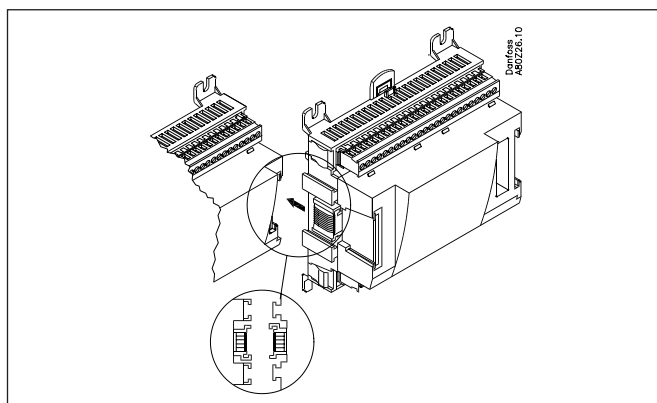
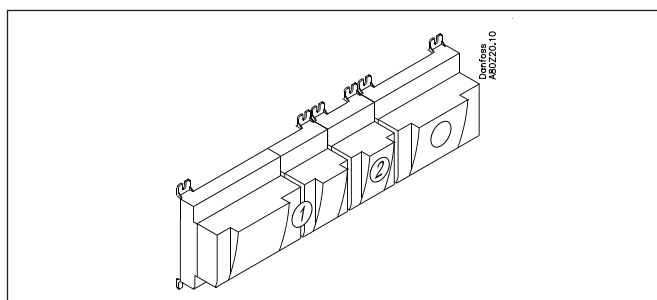

10

Determine the connection points

All connections must be programmed with module and point, so in principle it does not matter where the connections are made, as long as it takes place on a correct type of input or output.

- The controller is the first module, the next one is 2, etc.
- A point is the two or three terminals belonging to an input or output (e.g. two terminals for a sensor and three terminals for a relay).

The preparation of the connection diagram and the subsequent programming (configuration) should take place at the present time. It is most easily accomplished by filling in the connection survey for the relevant modules.

Principle:

Name	On module	On Point	Function
fx Compressor 1	x	x	Close
fx Compressor 2	x	x	Close
fx Alarm relay	x	x	NC
fx Main switch	x	x	Close
fx P0	x	x	AKS 32R 1-6 bar

The connection survey from the controller and any extension modules are uploaded from the paragraph "Module survey. E.g. controller module:

Signal	Module	Point	Terminal	Signal type / Active at
/		1 (AI 1)	1 - 2	
		2 (AI 2)	3 - 4	
		3 (AI 3)	5 - 6	
		4 (AI 4)	7 - 8	

- Columns 1, 2, 3 and 5 are used for the programming.
- Columns 2 and 4 are used for the connection diagram.

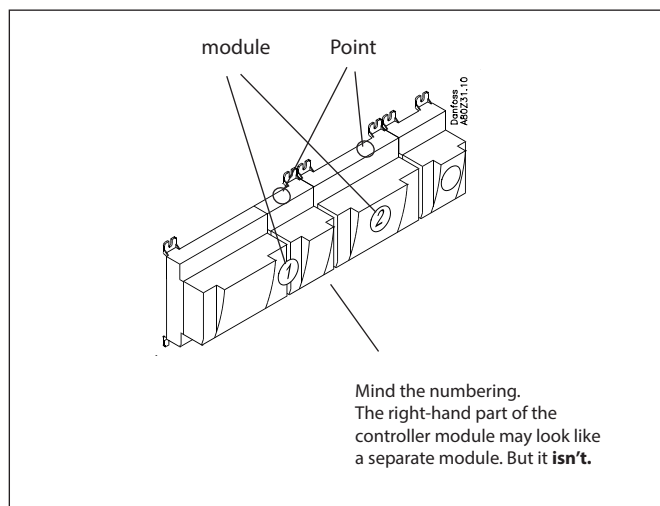

Hint
In appendix B, 16 general installation types are illustrated. If your installation is nearly similar to one of those illustrated, you can advantageously use the given connection points.

Example continued:

Signal	Module	Point	Terminal	Signal type / Active at
Brine return temperature S3	1	1 (AI 1)	1 - 2	Pt 1000
Brine supply temperature S4		2 (AI 2)	3 - 4	Pt 1000
Capacity limitation		3 (AI 3)	5 - 6	Sluttet
Pump flow switch		4 (AI 4)	7 - 8	Åben
Thermostat sensor in plant room - Saux1		5 (AI 5)	9 - 10	Pt 1000
External main switch		6 (AI 6)	11 - 12	Sluttet
Outdoor temperature - Sc3		7 (AI 7)	13 - 14	Pt 1000
Discharge temperature - Sd		8 (AI 8)	19 - 20	Pt 1000
Suction gas temperature- Ss		9 (AI 9)	21 - 22	Pt 1000
Suction pressure - P0		10 (AI 10)	23 - 24	AKS32-12
Condensing pressure - Pc		11 (AI 11)	25 - 26	AKS32-34
Compressor 1 / VSD		12 (DO 1)	31 - 32	ON
Compressor 2		13 (DO 2)	33 - 34	ON
Compressor 3		14 (DO 3)	35 - 36	ON
Compressor 4		15 (DO 4)	37 - 38	ON
		16 (DO 5)	39-40-41	
Liq. injec. in heat exchanger		17 (DO6)	42-43-44	ON
Pump 1		18 (DO7)	45-46-47	ON
Pump 2		19 (DO8)	48-49-50	ON
Speed control of compressor		24	-	0-10 V
		25	-	

Signal	Module	Point	Terminal	Active at
Fan 1	2	1 (DO 1)	25-26-27	On
Fan 2		2 (DO 2)	28-29-30	On
Fan 3		3 (DO 3)	31-32-33	On
Fan 4		4 (DO 4)	34-35-36	On
Defrost		5 (DO 5)	37-38-39	On
Fan in plant room		6 (DO 6)	40-41-42	On
Alarm		7 (DO 7)	43-44-45	Off
		8 (DO 8)	46-47-48	

Signal	Module	Point	Terminal	Active at
Compressor 1 Gen. Safety	3	1 (DI 1)	1 - 2	Open
Compressor 2 Gen. Safety		2 (DI 2)	3 - 4	Open
Compressor 3 Gen. Safety		3 (DI 3)	5 - 6	Open
Compressor 4 Gen. Safety		4 (DI 4)	7 - 8	Open
VSD, compressor speed		5 (DI 5)	9 - 10	Open
Frost protection		6 (DI 6)	11 - 12	Open
DI alarm, Receiver level		7 (DI 7)	13 - 14	Open
		8 (DI 8)	15 - 16	

Connection diagram

Drawings of the individual modules may be ordered from Danfoss.
Format = dwg and dxf.

You may then yourself write the module number in the circle and draw the individual connections.

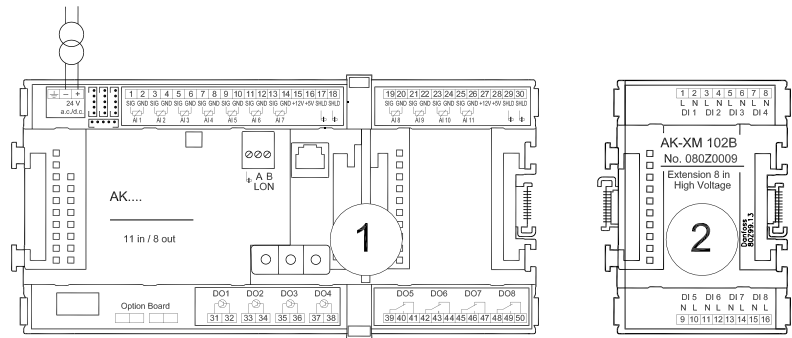

Example continued:

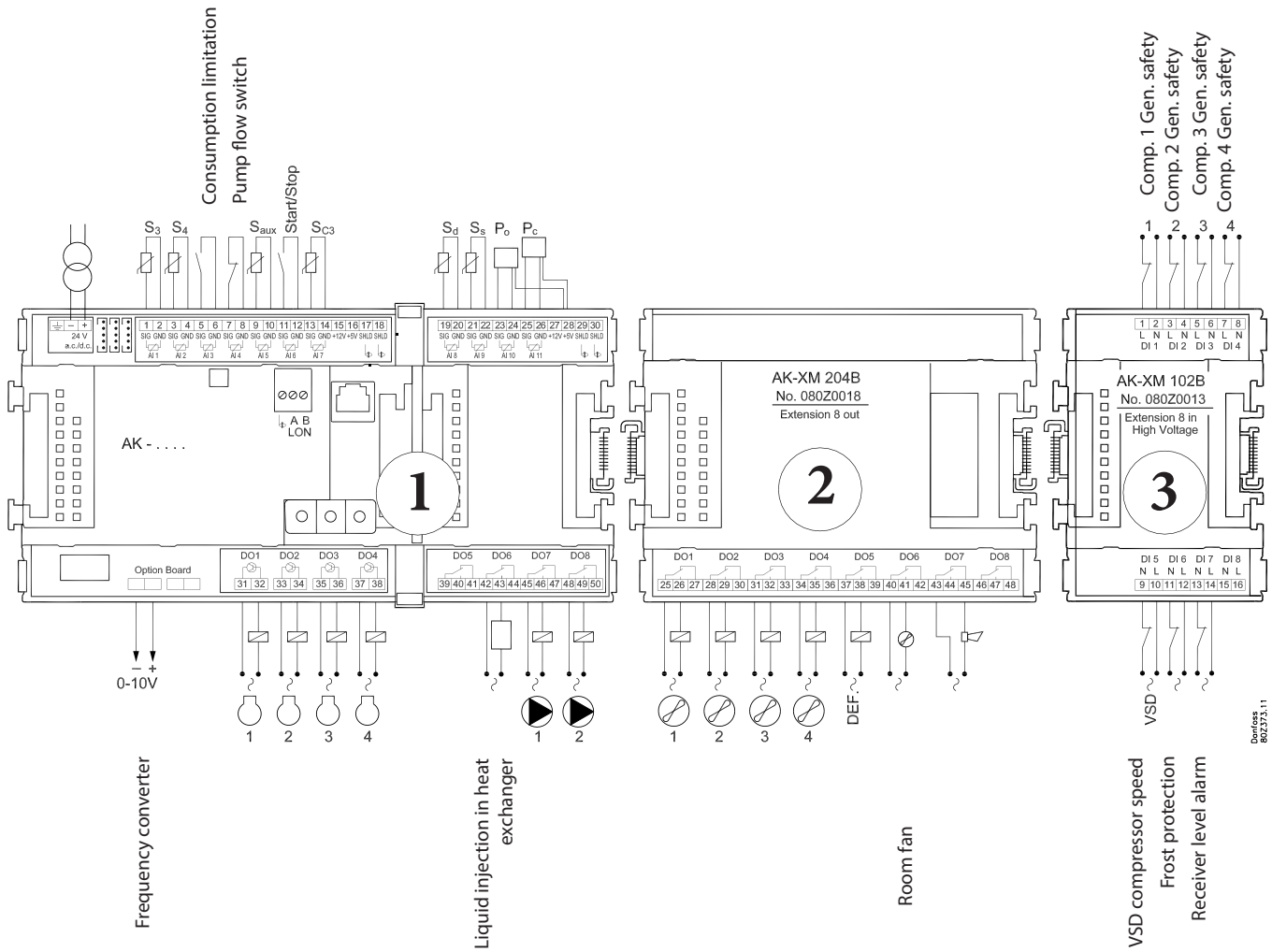

12 Supply voltage

Supply voltage is only connected to the controller module. The supply to the other modules is transmitted via the plug between the modules. The supply must be 24 V +/-20%. One transformer must be used for each controller. The transformer must be a class II. The 24 V must not be shared by other controllers or units. The analog inputs and outputs are **not** galvanically separated from the supply.

The + and - 24V input must not be earthed.

Transformer size

The power consumption grows with the number of modules used:

Module	Type	Number	á	Effect
Controller		1	x 8 =	8 VA
Extension module	200-series	_	x 5 =	_ VA
Extension module	100-series	_	x 2 =	_ VA
Total				_ VA

Example continued:

Controller module	8 VA
+ 1 extension module in 200-series	5 VA
+ 1 extension module in 100-series	2 VA

Transformer size (least)	15 VA

Common pressure transmitter

If several controllers receive a signal from the same pressure transmitter, the supply to the affected controllers must be wired so that it is not possible to switch off one of the controllers without also switching off the others. (If one controller is switched off, the signal will be pulled down, and all the other controllers will receive a signal which is too low)

Ordering

1. Controller

Type	Function	Application	Language	Code no.	Example continued
AK-CH 650	Controller for capacity control of compressors and condensers	Water chiller control	English, German, French, Dutch, Italian, Spanish, Portuguese, Danish, Swedish, Finnish, Russian, Czech, Polish, Chinese	080Z0132	x

2. Extension modules and survey for inputs and outputs

Type	Analog inputs	On/Off outputs		On/off supply voltage (DI signal)		Analog outputs	module with switches	Code no.	Example continued
	For sensors, pressure transmitters etc.	Relay (SPDT)	Solid state	Low voltage (max. 80 V)	High voltage (max. 260 V)	0-10 V d.c.	For override of relay outputs		
Controller	11	4	4	-	-	-	-	-	
Extension modules									
AK-XM 101A	8							080Z0007	
AK-XM 102A				8				080Z0008	x
AK-XM 102B					8			080Z0013	
AK-XM 103A	4					4		080Z0032	
AK-XM 204A		8						080Z0011	
AK-XM 204B		8					x	080Z0018	x
AK-XM 205A	8	8						080Z0010	
AK-XM 205B	8	8					x	080Z0017	
The following extension module can be placed on the PC board in the controller module. There is only room for one module.									
AK-OB 110						2		080Z0251	x

3. AK operation and accessories

Type	Function	Application	Code no.	Example continued
Operation				
AK-ST 500	Software for operation of AK controllers	AK-operation	080Z0161	x
-	Cable between PC and AK controller	AK - Com port	080Z0262	x
-	Cable between zero modem cable and AK controller / Cable between PDA cable and AK controller	AK - RS 232	080Z0261	
-	Cable set + converter between PC and AK controller	AK - USB	080Z0264	
Accessories Power supply module 230 V / 115 V to 24 V				
AK-PS 075	18 VA	Supply for controller	080Z0053	x
AK-PS 150	36 VA		080Z0054	
Accessories External display that can be connected to the controller module. For showing, say, the suction pressure				
EKA 163B	Display		084B8574	
EKA 164B	Display with operation buttons		084B8575	
-	Cable between display and controller	Length = 2 m	084B7298	
		Length = 6 m	084B7299	
Accessories Real time clock for use in controllers that require a clock function, but are not wired with data communication.				
AK-OB 101A	Real time clock with battery backup.	To be mounted in an AK controller	080Z0252	

3. Mounting and wiring

This section describes how the controller:

- Is fitted
- Is connected

We have decided to work on the basis of the example we went through previously, i.e. the following modules:

- AK-CH 650 controller module
- AK-XM 204B relay module
- AK-XM 102B digital input module
- AK-OB 110 analog output module

Mounting

Mounting of analog output module

1. Lift the top part off the basic module

The basic module must not be connected to voltage.

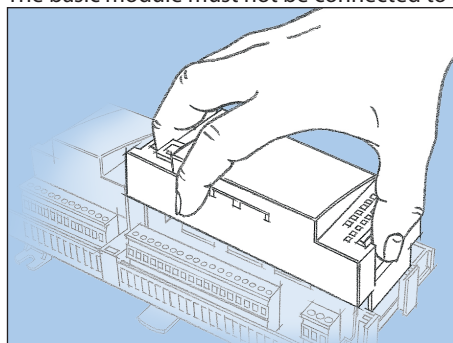

Press in the plate on the left-hand side of the light-emitting diodes and the plate on the right-hand side for the red address changers.

Lift the top part off the basic module.

2. Mount the extension module in the basic module

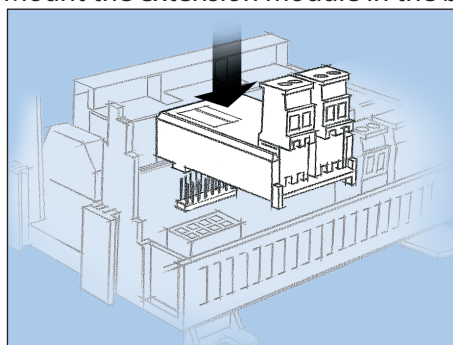

3. Put the top part back on the basic module

The analog extension module will supply a signal to the variable frequency drive.

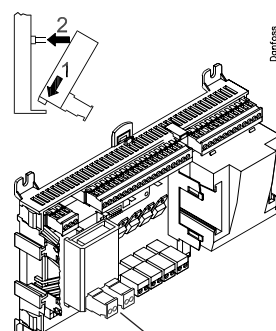

There are two outputs, but we only use one in the example.

Mounting of extension module on the basic module

1. Move the protective cap

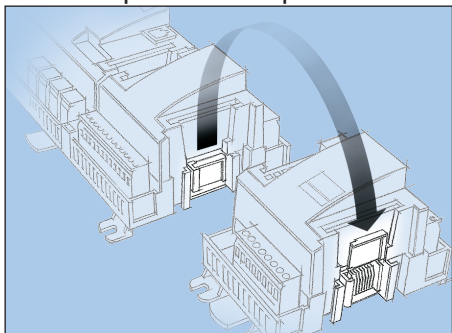

Remove the protective cap from the connection plug on the right-hand side of the basic module.
Place the cap on the connection plug to the right of the extension module that is to be mounted on the extreme right-hand side of the AK assembly.

2. Assemble the extension module and the basic module

The basic module must not be connected to voltage.

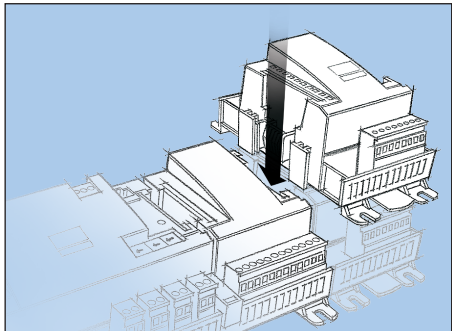

In our example two extension modules are to be fitted to the basic module. We have chosen to fit the module with relays directly on the basic module and then the module with input signals. The sequence is thus:

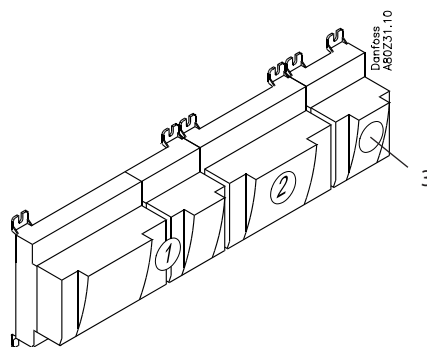

All the subsequent settings that affect the two extension modules are determined by this sequence.

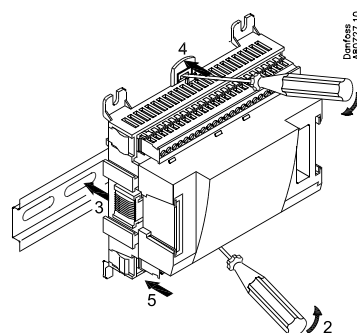
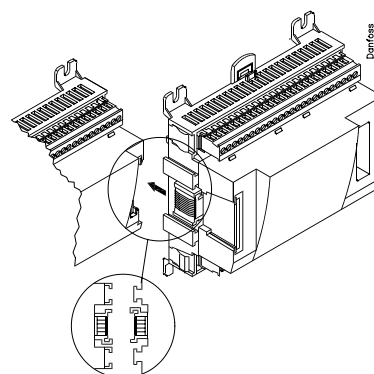

When the two snap catches for the DIN rail mounting are in the open position, the module can be pushed into place on the DIN rail – regardless of where the module is on the row.
Disassembly is thus done with the two snap catches in the open position.

Wiring

Decide during planning which function is to be connected and where this will be.

1. Connect input and outputs

Here are the tables for the example:

Signal	Module	Point	Terminal	Signal type / Active at
Brine return temperature S3	1	1 (AI 1)	1 - 2	Pt 1000
Brine supply temperature S4		2 (AI 2)	3 - 4	Pt 1000
Consumption limitation		3 (AI 3)	5 - 6	Closed
Pump flow switch		4 (AI 4)	7 - 8	Open
Thermostat sensor in plant room - Saux1		5 (AI 5)	9 - 10	Pt 1000
External main switch		6 (AI 6)	11 - 12	Closed
Outdoor temperature - Sc3		7 (AI 7)	13 - 14	Pt 1000
Discharge gas temperature - Sd		8 (AI 8)	19 - 20	Pt 1000
Suction gas temperature - Ss		9 (AI 9)	21 - 22	Pt 1000
Suction pressure - P0		10 (AI 10)	23 - 24	AKS32-12
Condenser pressure - Pc		11 (AI 11)	25 - 26	AKS32-34
Compressor 1 / VSD		12 (DO 1)	31 - 32	ON
Compressor 2		13 (DO 2)	33 - 34	ON
Compressor 3		14 (DO 3)	35 - 36	ON
Compressor 4		15 (DO 4)	37 - 38	ON
		16 (DO 5)	39-40-41	
Liquid injec. in heat exchanger		17 (DO6)	42-43-44	ON
Pump 1		18 (DO7)	45-46-47	ON
Pump 2		19 (DO8)	48-49-50	ON
Speed control of compressors		24	-	0-10 V
		25	-	

Signal	Module	Point	Terminal	Active at
Fan 1	2	1 (DO 1)	25-26-27	On
Fan 2		2 (DO 2)	28-29-30	On
Fan 3		3 (DO 3)	31-32-33	On
Fan 4		4 (DO 4)	34-35-36	On
Defrost		5 (DO 5)	37-38-39	On
Fan in plant room		6 (DO 6)	40-41-42	On
Alarm		7 (DO 7)	43-44-45	Off
		8 (DO 8)	46-47-48	

Signal	Module	Point	Terminal	Active at
Compressor 1 Gen. safety	3	1 (DI 1)	1 - 2	Open
Compressor 2 Gen. safety		2 (DI 2)	3 - 4	Open
Compressor 3 Gen. safety		3 (DI 3)	5 - 6	Open
Compressor 4 Gen. safety		4 (DI 4)	7 - 8	Open
VSD, compressor speed		5 (DI 5)	9 - 10	Open
Frost protection		6 (DI 6)	11 - 12	Open
DI alarm, Receiver level		7 (DI 7)	13 - 14	Open
		8 (DI 8)	15 - 16	

The function of the switch functions can be seen in the last column.

There are AKS 32 pressure transmitters for several pressure ranges. Here there are two different ones. One up to 12 bar and one up to 34 bar.

The connections for the example can be seen here.

The screen on the pressure transmitter cables must only be connected at the end of the controller.

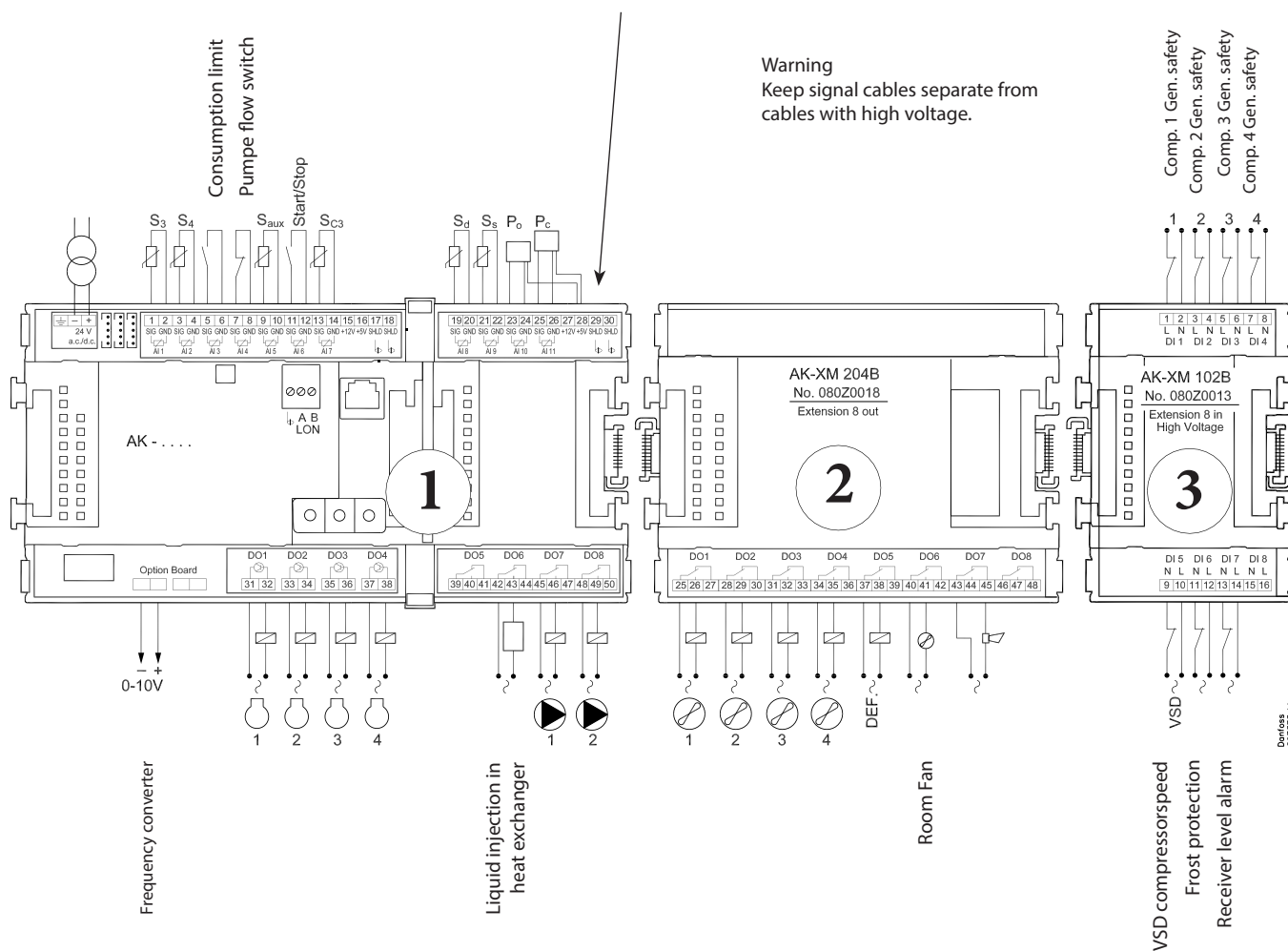

2. Connect LON communication network

The installation of the data communication must comply with the requirements set out in document RC8AC.

3. Connect supply voltage

Is 24 V, and the supply must not be used by other controllers or devices. The terminals must not be earthed.

4. Follow light-emitting diodes

When the supply voltage is connected the controller will go through an internal check. The controller will be ready in just under one minute when the light-emitting diode "Status" starts flashing slowly.

5. When there is a network

Set the address and activate the Service Pin.

6. The controller is now ready to be configured.

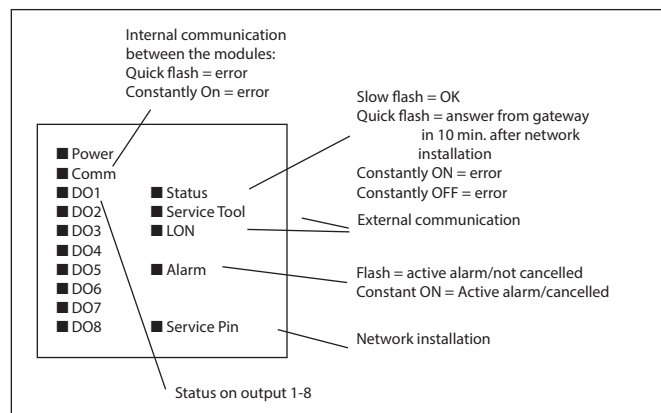

4. Configuration and operation

This section describes how the controller:

- Is configured
- Is operated

We have decided to work on the basis of the example we went through previously, i.e. compressor control with 4 compressors and condenser control with 4 fans.

The example is shown overleaf.

Refrigerating plant example

We have decided to describe the setup by means of an example comprising a compressor group and a condenser. The example is the same as the one given in the "Design" section, i.e. the controller is an AK-CH 650 + extension modules.

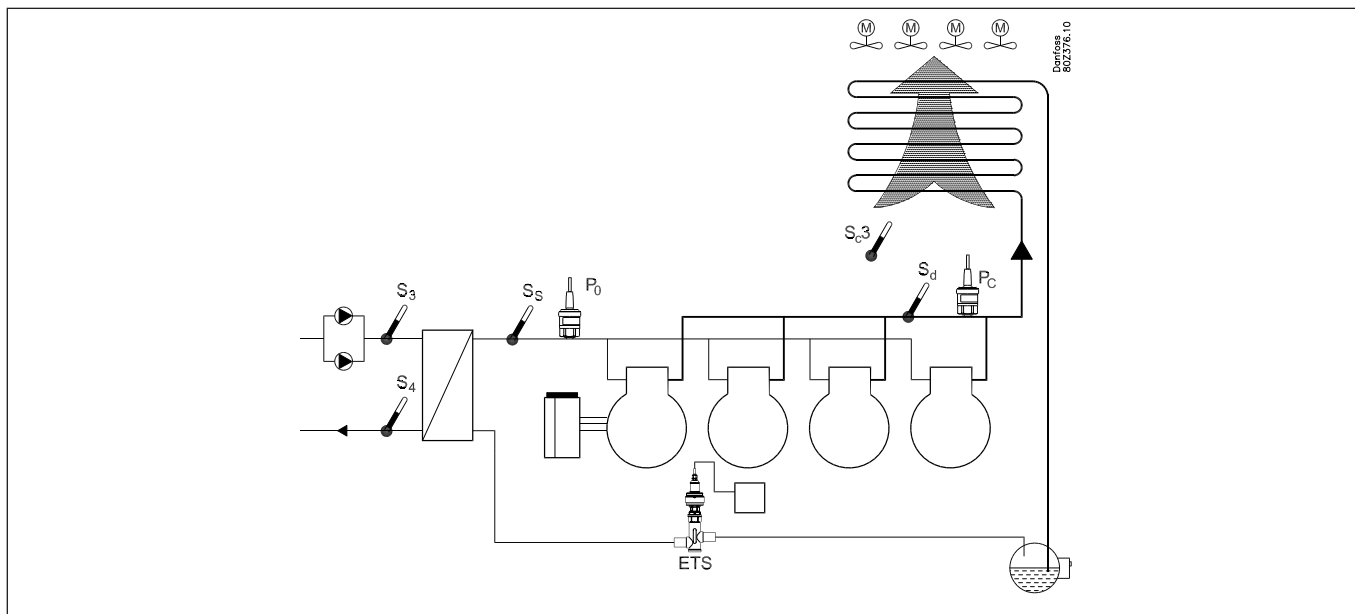

Compressor pack:

- Refrigerant R404A
- 1 only speed-regulated compressor (30 kW, 30-60 Hz)
- 3 only compressors (15 kW) with working-hour equalisation
- Safety monitoring of each compressor + frequency converter
- Capacity limitation of compressors via contact signal (load shedding)
- Injection signal to heat exchanger
- Frost protection input (230 V a.c.)
- S4 setting 2°C

Air cooled condenser:

- 4 fans, step regulation
- Pc regulates based on outdoor temperature Sc3

Pumps + defrost:

- Start/stop of 2 twin pumps
- Monitoring via flow switch (contact signal)
- Output for defrost

Receiver:

- Monitoring of liquid level (230 V a.c.)

Fan i plant room:

- Thermostat control of fan in plant room (sensor + output)

Safety functions:

- Monitoring of Po, Pc, Sd and superheat on suction line
- P0 min. = -10°C
- Pc max. = 50°C
- Sd max. = 120°C
- SH min. = 5°C, SH max = 35°C

Other:

- Alarm output used
- External main switch used

For the example shown we use the following modules:

- AK-CH 650 basic module
- AK-XM 102B digital input module
- AK-XM 204B relay module
- AK-OB 110 analog output module

NB!

Not all the compressors can have their speed adjusted.

The capacity of the compressor with speed adjustment should be greater than that of the other compressors. This ensures that there are no "gaps" in the cut in capacity. See chapter 5, Adjustment functions.

There is also an internal main switch as a setting. Both must be "ON" before any adjustment is made.

The modules used are selected in the design phase.

Configuration

Connect PC

PC with the program "Service Tool" is connected to the controller.

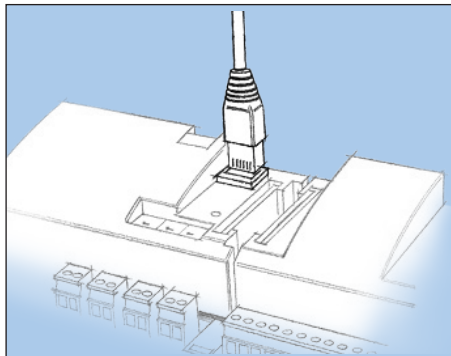

The controller must be switched on first and the LED "Status" must flash before the Service Tool programme is started.

Start Service Tool programme

Login with user name SUPV

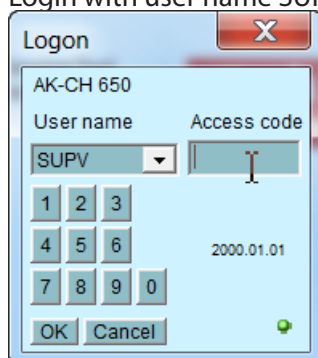

Select the name **SUPV** and key in the access code.

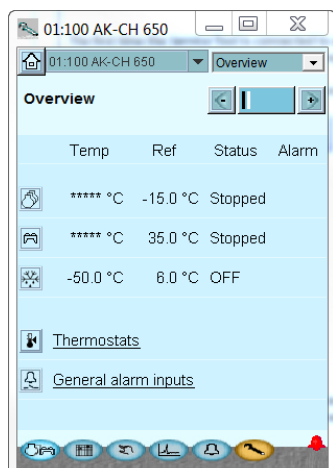

For connecting and operating the "AK service tool" software, please see the manual for the software.

The first time the Service Tool is connected to a new version of a controller the start-up of the Service Tool will take longer than usual while information is retrieved from the controller. Time can be followed on the bar at the bottom of the display.

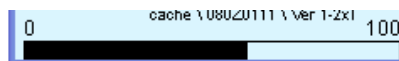

When the controller is supplied the SUPV access code is 123. When you are logged into the controller an overview of it will always appear.

In this case the overview is empty. This is because the controller has not yet been set up. The red alarm bell at the bottom right tells you that there is an active alarm in the controller. In our case the alarm is due to the fact that the time in the controller has not yet been set.

Authorization

1. Go to Configuration menu

Press the orange setup button with the spanner at the bottom of the display.



2. Select Authorization

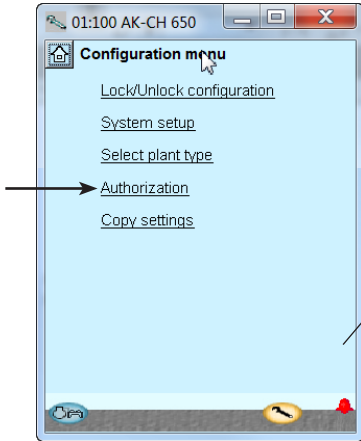

When the controller is supplied it has been set with standard authorization for different user interfaces. This setting should be changed and adapted to the plant. The changes can be made now or later.

You will use this button again and again whenever you want to get to this display. On the left-hand side are all the functions not shown yet. There will be more here the further into the setup we go.

Press the line **Authorization** to get to the user setup display.

3. Change setting for the user 'SUPV'

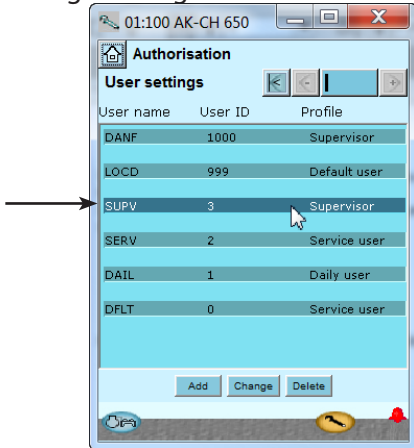

Mark the line with the user name **SUPV**. Press the button **Change**

This is where you can select the supervisor for the specific system and a corresponding access code for this person.

4. Select user name and access code

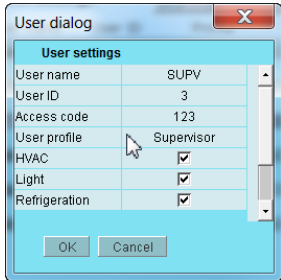

In earlier versions of the service tool AK-ST 500 it was possible to select the language in this menu.

An updated version of the service tool will be released in the spring of 2009. If the controller is operated with the new version, language selection will happen automatically in connection with the configuration of the service tool.

The controller will utilize the same language that is selected in the service tool but only if the controller contains this language. If the language is not contained in the controller, the settings and readings will be shown in English.

5. Carry out a new login with the user name and then access code

To activate the new settings you must carry out a new login to the controller with the new user name and the relevant access code. You will access the login display by pressing the icon at the top left corner of the display.



Unlock the configuration of the controllers

1. Go to Configuration menu



2. Select Lock/Unlock configuration

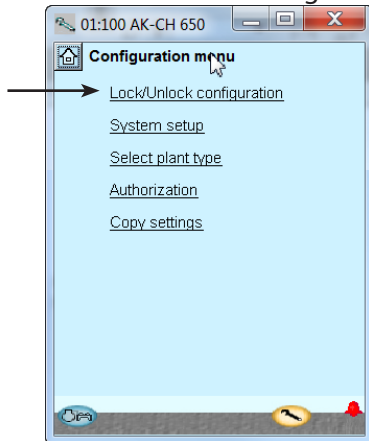

3. Select Configuration lock

Press the blue field with the text **Locked**

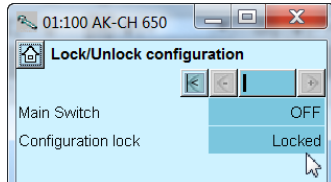

4. Select Unlocked

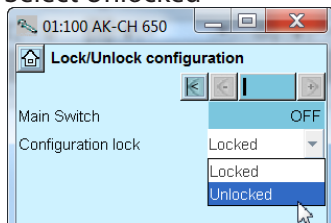

The controller can only be configured when it is unlocked. It can only be adjusted when it is locked.

Changes to the input and output settings are only activated once the controller is "Locked".

The values can be changed when it is locked, but only for those settings that do not affect the configuration.

System setup

1. Go to Configuration menu



2. Select System setup

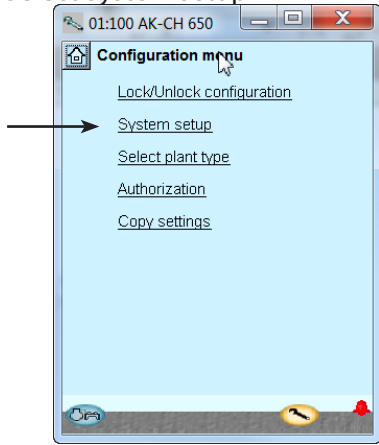

All system settings can be changed by pressing in the blue field with the setting and then indicating the value of the required setting.

In the first field you enter a name for what the controller will be controlling.

When the time is set the PC's time can be transferred to the controller. When the controller is connected to a network, date and time will automatically be set by the system unit in the network. This also applies to change-over Daylight saving.

3. Set system settings

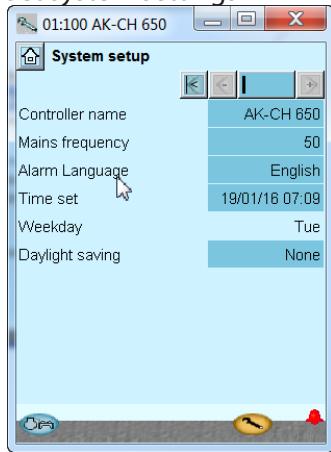

Set plant type

1. Go to Configuration menu

2. Select plant type

Press the line **Select plant type**.

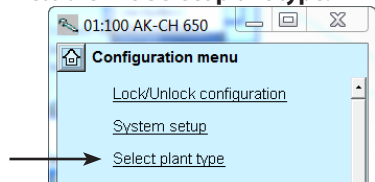

3. Set plant type

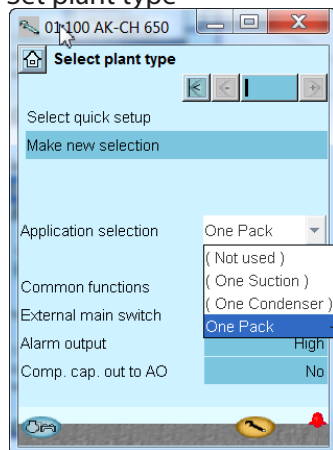

4. Set Common functions

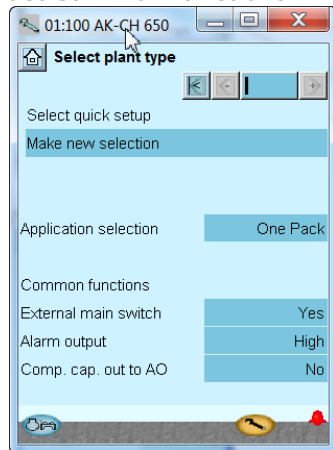

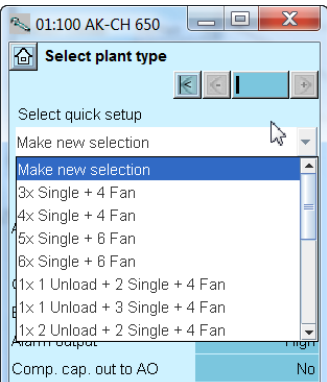

The higher of the two settings gives a choice between a number of predefined combinations, which at the same time determine the connection points.

At the end of the manual there is an overview of the options and connection points.

After configuration of this function, the controller will shut down and restart. After the restart, a large number of settings will have been made. These include the connection points. Continue with the settings and check the values.

If you change some of the settings, the new values will come into force.

When the installation type is to be configured, it can be done in two ways: Either one of these two (we chose to use the lowest).

In our example we want the controller to control both a compressor group and a condenser group. We therefore select the plant type **One pack**.

Further settings:
 External main switch to **Yes**
 Use Alarm output to **High**. (At "High" the relay is only activated for high-priority alarms).

The controller can transmit a 0-10 V signal that indicates how much of the compressor capacity is cut in. We do not use this signal in the example.

Set control of compressors

1. Go to Configuration menu

2. Select Suction group

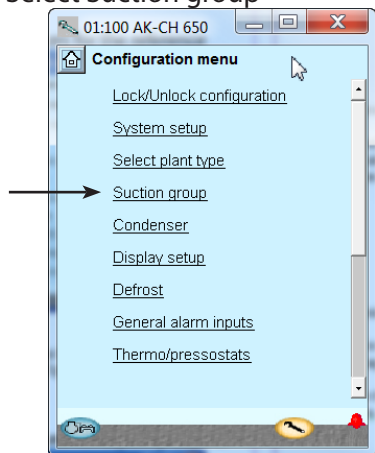

The configuration menu in the Service Tool has changed now. It shows the possible settings for the selected plant type.

3. Set values for the reference

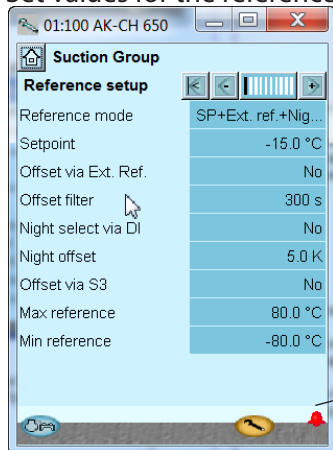

In our example we select the settings:
 - Suction set point = -15°C
 - Night offset value = 5 K.
 The settings are shown here in the display.

There are several pages, one after the other. The black bar in this field tells you which of the pages is currently displayed. Move between the pages using the + and - buttons.

Press the +-button to go on to the next page

4. Set values for capacity control

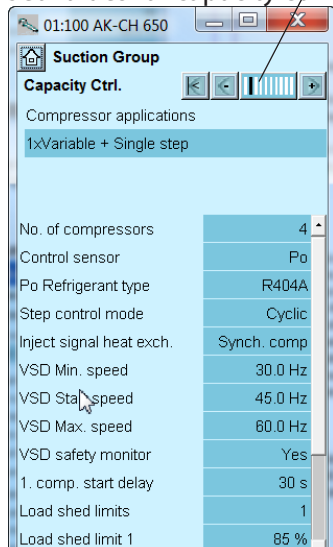

In our example we select:
 - 4 compressors
 - P0 as signal to the regulation
 - Refrigerant = R404A
 - Equalisation of working hours
 - Value for speed regulation
 Speed regulation can always only be on compressor number 1.
 The settings are shown here in the display.

Not all compressors can have their speed adjusted. If there is any doubt, contact your compressor supplier.

If you want to know more about the different configuration options, they are listed below. The number refers to the number and picture in the column on the left.

3 - Reference mode

Displacement of suction pressure as a function of external signals

0: Reference = set reference + night offset + offset from external 0-10 V signal

1: Reference = set reference + offset from P0 optimization + Night displacement

Set point (-80 to +30°C)

Setting of required suction pressure in °C

Offset via Ext. Ref

Select whether a 0-10V external reference override signal is required

Offset at max input (-100 to +100 °C)

Displacement of reference at max. Ext. Ref. signal

Offset at min input (-100 to +100 °C)

Displacement of reference at min. Ext. Ref signal

Offset filter (10 - 1800 Sec)

Filter for displacement of reference, higher value results in slower displacement

Night select via DI

Select whether a digital input is required for activation of night operation. Night operation can alternatively be controlled via internal weekly schedule or from the system manager via data communication

Night Offset (-25 to +25 K)

Displacement of the brine temperature during night operation (set in Kelvin)

Offset via S3

The reference selection must be displaced by a signal from S3.

Tref S3 offset

Set the S3 temperature where it is not to be offset.

K1 S3 offset

Set the size of the change to be made in the reference when the S3 temperature deviates 1 degree from the setting. (-10 to 10 K)

Max reference (-50 to +80 °C)

Max. permissible brine reference

Min reference (-80 to +25 °C)

Min. permissible brine reference.

4 - Compressor application

Select the compressor application required

No. of compressors

Set number of compressors

No. of unloaders

Set number of unloader valves

Regulation sensor

Select either P0 or S4

P0 Refrigerant

Select refrigerant type

Po refrigerant factors K1, K2, K3

Only used if "Po refrigerant type" is set to custom (contact Danfoss for information)

Step control mode

Select coupling pattern for compressors

Sequential: Compressors are cut in/out in strict accordance with compressor number (FILO)

Cyclic: Runtime equalisation between compressors (FIFO)
 Best fit: Compressors are cut in/out in order to make the best possible fit to actual load

Injection heat exchanger

If the function is selected, injection can be coordinated with compressor operation in one of two ways:

Synchronisation: Simultaneously with compressor operation.

Pump down: Like synchronisation, but it is terminated with pump down, where the valve is shut and the last compressor disengaged once "Pump down limit" is reached.

Pump down

Select whether a pump down function is required on the last running compressor



Press the +-button to go on to the next page

5. Set values for capacity of the compressors

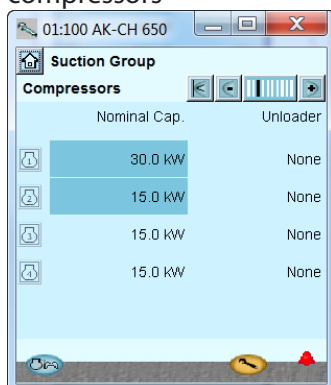

Press the +-button to go on to the next page

6. Set values for main step and any unloaders

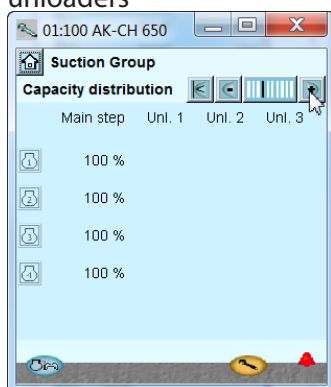

Press the +-button to go on to the next page

7. Set values for safe operation

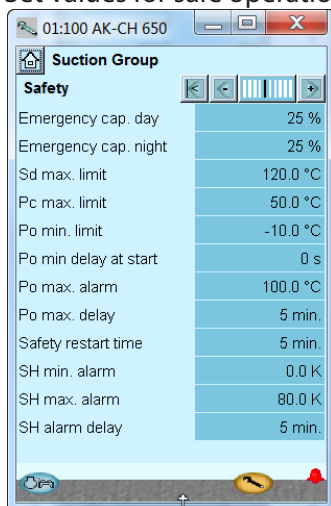

In our example we select:
 - Speed-controlled compressor of 30 kW (compressor 1)
 - 3 compressors of 15 kW

In our example there are no unloaders and hence no changes.

In our example we select:
 - Safety limit for discharge temperature = 120°C
 - Safety limit for high condensing pressure = 50°C
 - Safety limit for low suction pressure = -10°C
 - Alarm limit for min. and max. superheat, respectively = 5 and 35 K.

Pump down limit (-80 to +30 °C)
 Select pump down limit

VSD min speed (0.5 – 60.0 Hz)
 Minimum allowed speed before stop of Variable Speed drive (Low load condition)

VSD start speed (20.0 – 60.0 Hz)
 Minimum speed for start of Variable speed drive (Must be set higher than "VSD Min. Speed Hz")

VSD max speed (40.0 – 120.0 Hz)
 Highest permissible speed for the compressor motor

VSD safety monitoring
 Select this if input for monitoring of the frequency converter is required.

Start delay first compressor (5-600 sec.)
 To ensure brine flow before startup, a delay before start of the first compressor can be entered.

Load shed limits
 Select how many load shedding inputs are required

Load shed limit 1
 Set max capacity limit for load shed input 1

Load shed limit 2
 Set max capacity limit for load shed input 2

Override limit Po
 Any load below the limit value is freely permitted. If the P0 exceeds the value, a time delay is started. If the time delay expires, the load limit is cancelled

Override delay 1
 Max. time for capacity limit, if P0 is too high

Override delay 2
 Max. time for capacity limit, if P0 is too high

Advanced control settings
 Select whether the advanced capacity control settings should be visible

Kp S4
 Amplification factor for P0 regulation (0.1 – 10.0)

Min. capacity change (0 – 100 %)
 Minimum change in requested capacity that will result in cut in/out of compressors.

Initial start time (15 – 900 s)
 The time after start-up where the cut-in capacity is limited to the first compressor step.

Unloading mode
 Select whether one or two capacity controlled compressors are allowed to be unloaded at the same time at decreasing capacity

5 - Compressors
 In this screen the capacity distribution between the compressors is defined.
 Capacities that need to be set depend upon the "compressor application" and "Step control mode" that has been selected.

Nominal capacity (0.0 – 100000.0 kW)
 Set the nominal capacity for the compressor in question. For compressors with variable speed drive the nominal capacity must be set for the mains frequency (50/60 Hz)

Unloader
 Number of unload valves for each compressor (0-3)

6 - Capacity distribution
 The installation is dependent on the combination of compressors and coupling pattern.

Main step
 Set the nominal capacity of the main step (Set the percentage of the relevant compressor's nominal capacity) 0 - 100%.

Unload
 Readout of the capacity on every unloading 0-100%.

7 - Safety

Emergency cap. day
 The desired cut-in capacity for daily use in the case of emergency operations resulting from error in the suction pressure sensor/ media temperature sensor.

Emergency cap. night
 The desired cut-in capacity for night operations in the case of emergency operations resulting from error in the suction pressure sensor/ media temperature sensor.

Sd max limit
 Max. value for discharge gas temperature
 10 K below the limit, the compressor capacity should be

Press the +-button to go on to the next page

8. Set monitoring of compressor

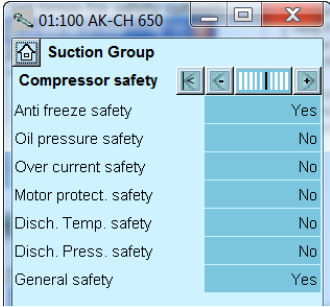

Press the +-button to go on to the next page

9. Set operation time for compressor

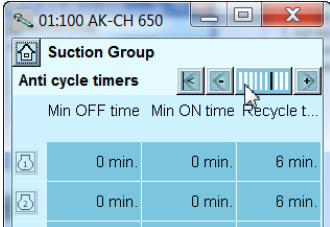

Press the +-button to go on to the next page

10. Set times for safety cutouts

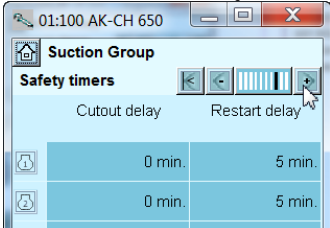

Press the +-button to go on to the next page

11. Set Misc. function

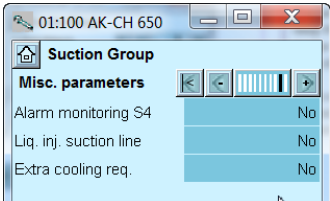

Press the +-button to go on to the next page

12. Setting pump functions

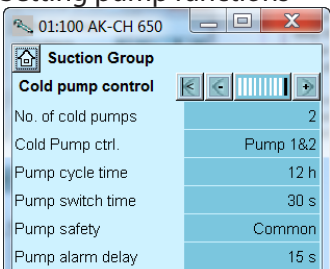

In our example we use:
 - Frost protection
 - One general safety monitoring unit for each compressor
 (The remaining options could have been selected if specific safety controls for each compressor had been required)

Set min. OFF-time for the compressor relay
 Set min. ON-time for the compressor relay
 Set how often the compressor is allowed to start

The settings only apply to the relay that cuts the compressor motor in and out. They do not apply to unloaders.

If the restrictions overlap, the controller will use the longest restriction time.

In our example we do not use these functions.

reduced and the entire condenser capacity will be cutin. If the limit is exceeded, the entire compressor capacity will be cutout

Pc Max limit

Maximum value for the condenser pressure in °C 3 K below the limit, the entire condenser capacity will be cutin and the compressor capacity reduced.

If the limit is exceeded, the entire compressor capacity will be cutout.

P0 Min limit

Minimum value for the suction pressure in °C

If the limit is reduced, the entire compressor capacity will be cutout.

P0 min delay at start-up (0-600 sec)

Low pressure cut-out can be delayed for cut-out to be avoided.

Safety restart time

Common time delay before restarting the compressor.

(Applicable to the functions: "Sd max. limit", Pc max. limit" and "P0 min. limit).

SH Min alarm

Alarm limit for min. superheat in suction line.

SH Max alarm

Alarm limit for max. superheat in suction line.

SH alarm delay

Time delay before alarm for min./max. superheat in suction line.

8 - Compressor safety

Frost protection

Choose whether an overall, joint security inlet for all compressors is desired. If the alarm is activated, all compressors will be disengaged.

Oil pressure etc

Define here whether this type of protection should be connected.

For "General", there is a signal from each compressor.

9 - Minimum operation times

Configure the operation times here so "unnecessary operation" can be avoided.

Restart time is the time interval between two consecutive starts.

10 - Safety timer

Cutout delay

The time delay resulting from drop-out of automated safety measures and until the compressor-error is reported. This setting is common for all safety inputs for the relevant compressor.

Restart delay

Minimum time that a compressor should be OK after a safety cut-out. After this interval it can start again.

11 - Misc. functions

Alarm monitoring S4

Alarm option in the case of too high and too low S4

Different time delays are connected

Liq. inj suction line

Select the function if a liquid injection is required in the suction line in order to keep the discharge gas temperature down.

Extra cooling req.

The controller can activate a relay if it cannot keep the temperature down. The function has a temperature setting and two delay times.

12 - Pumps

No of pumps (0, 1 or 2)

Cold pump control

Pump operation is defined here:

0: No pumps in operation

1: Only pump 1 in operation

2: Only pump 2 in operation

3: Both in operation

4: Operating time equalisation. Start before stop

5: Operating time equalisation. Stop before start

Pump cycle time

Operating time before changeover to the second pump (1-500h)

Pump switch time

Overlapping time, where both pumps are in operation with "start before stop" or break time with "stop before start" (0-600 sec)

Pump safety

Select Common if monitored with flow switch

Select Individual if DI-signals are received from relays

Pump alarm delay

Delay from drop out to alarm.

Setup control of condenser

1. Go to Configuration menu

2. Select Condenser

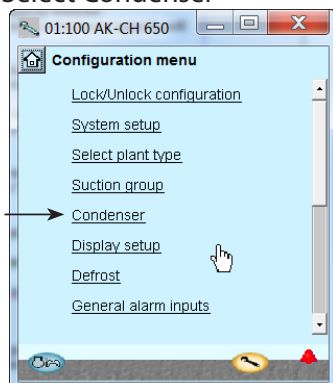

3. Set control mode and reference

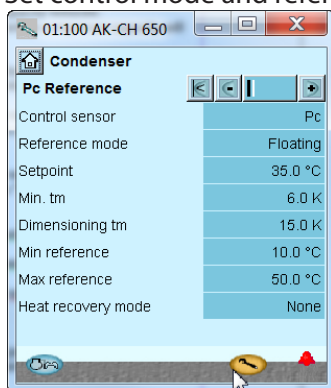

In our example the condenser pressure is controlled on the basis of the outdoor temperature (floating reference). The settings shown here in the display.

 Press the +-button to go on to the next page

4. Set values for capacity regulation

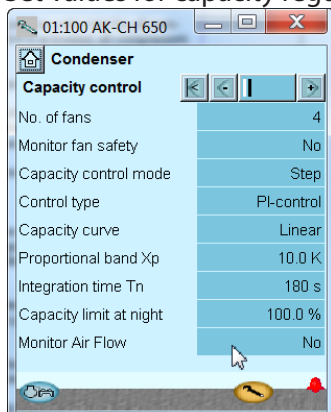

Used in our example are four step-controlled fans. The settings shown here in the display.

For your information the function "Monitor fan safety" will require an input signal from each fan.

3 - PC reference

Control sensor

Pc: The condensing pressure PC is used for regulation

S7: Media temperature is used for regulation

Reference Mode

Choice of condenser pressure reference

Fixed setting: Used if a permanent reference is required = "Setting"

Floating: Used if the reference is changed as a function of Sc3 the external temperature signal, the configured "Dimensioning tm K"/"Minimum tm K" and the actual cut in compressor capacity.

Setpoint

Setting of desired condensing pressure in °C

Min. tm

Minimum average temperature difference between Sc3 air and Pc condensing temperature with no load.

Dimensioning tm

Dimensioning average temperature differential between Sc3 air and Pc condensing temperature at maximum load (tm difference at max load, typically 8-15 K).

Min reference

Min. permitted condenser pressure reference

Max reference

Max. permitted condenser pressure reference

Heat recovery mode

Choice of method for heat recovery

No: Heat recovery not used

Thermostat: Heat recovery operated from thermostat

Digital input: Heat recovery operated from signal on a digital input.

Heat recovery relay

Choose whether an output is required that should be activated during heat recovery.

Heat recovery ref

Reference for the condensing pressure, when heat recovery is activated.

Heat recovery ramp down

Configure how quickly the reference for the condenser pressure should be ramped down to normal level after heat recovery. Configure in Kelvin per minute.

Heat recovery cutout

Temperature value where the thermostat cuts-out the heat recovery.

Heat recovery cutin

Temperature value where the thermostat cuts-out the heat recovery.

4 - Capacity control

Pc Refrigerant

Select refrigerant

Pc refrigerant factors K1, K2, K3

Only used if "Pc refrigerant type" is set to custom (contact Danfoss for information)

No of fans

Set number of fans.

Monitoring fan safety

Safety monitoring of fans. A digital input is used to monitor each fan.

Capacity control mode

Select control mode for condenser

Step: Fans are step-connected via relay outputs

Step/speed: The fan capacity is controlled via a combination of speed control and step coupling

Speed: The fan capacity is controlled via speed control (frequency converter)

Speed control on first step, rest=step

Control type

Choice of control strategy

P-band: The fan capacity is regulated via P-band control. The P band is configured as "Proportional band Xp"

PI-Control: The fan capacity is regulated by the PI controller.

Capacity curve

Choice of capacity curve type

Linear: The same amplification in the entire area

Square: Square curve shape, which gives higher amplification at higher loads.

Continued

VSD start speed

Minimum speed for start of speed control (Must be configured higher than "VSD Min. Speed %")

VSD min Speed

Minimum speed whereby speed control is cut-out (low load).

Proportional band Xp

Proportional band for P/PI controller

Integration time Tn

Integration time for PI controller

VSD safety monit.

Choice of safety monitoring of frequency converter. A digital inlet is used for monitoring the frequency converter.

Capacity limit at night

Setting of maximum capacity limit during night operations. Can be used to limit fan speed at night in order to limit the noise level.

Monitor Air flow

Choose whether monitoring is required of the condenser's air flow via an intelligent error-detection method.

Monitoring requires the use of a Sc3 outer temperature sensor, which must be fitted by the condenser's air inlet.

FDD setting

Set error-detection function

Tuning: The controller makes an adjustment to the condenser concerned.

Note that tuning should only be done when the condenser is operating under normal operating conditions.

ON: Tuning is completed and monitoring has commenced.

OFF: Monitoring is cut out.

FDD sensitivity

Set the sensitivity of error-detection on the condenser's air flow. Must only be changed by trained staff.

Air flow tuning value

Setup Display

1. Go to Configuration menu

2. Select Display setup

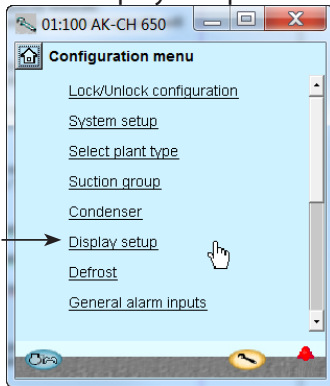

3. Define which readings are to be shown for the individual outputs

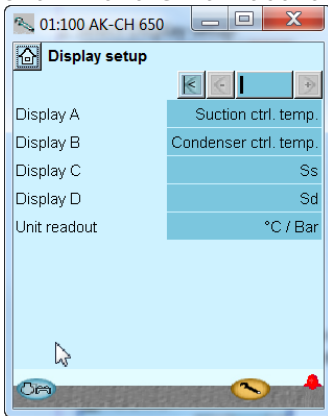

In our example, separate displays are not used. The setting is included here for information.

3 - Display setup

Display

The following can be read for the four outputs..

- Comp. control sensor
- P0
- P0 bar (abs)
- S3
- S4
- Ss
- Sd
- Cond. control sensor
- Pc
- Pc Bar (abs)
- S7

Unit readout

Choose whether readings are to be in SI units (°C and bar) or (US-units °F and psi)

Setup defrost

1. Go to Configuration menu

2. Select Defrost

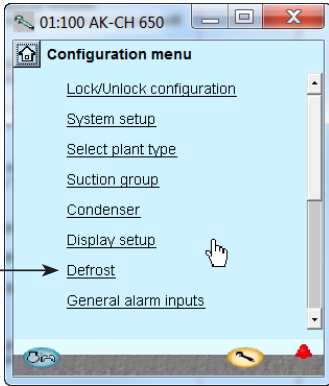

3. Define the required defrost functions

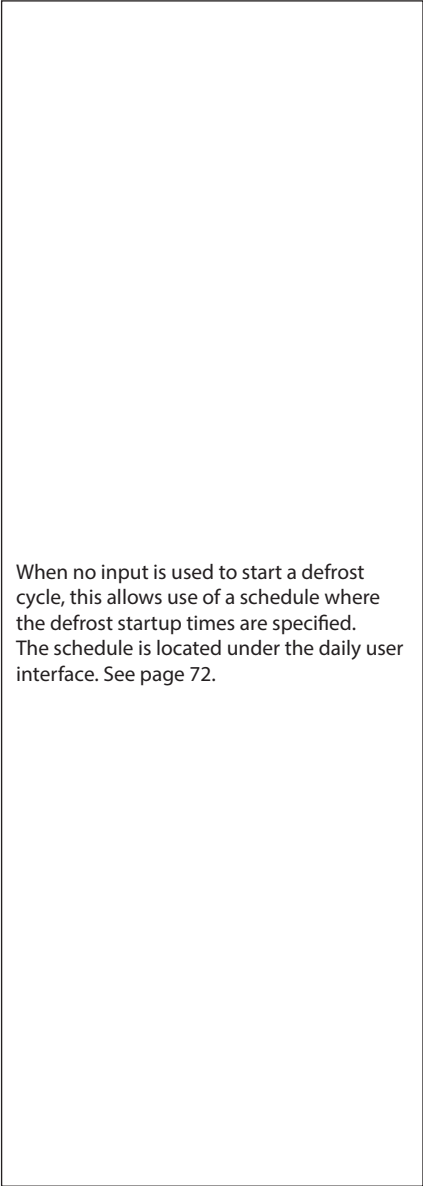
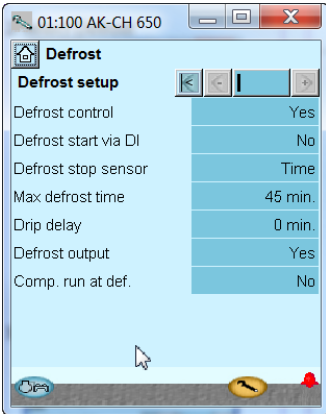

When no input is used to start a defrost cycle, this allows use of a schedule where the defrost startup times are specified. The schedule is located under the daily user interface. See page 72.

Actual tuning values for air flow.

3 - Defrost functions

Defrost function

Select whether defrost control is to be used

Defrost start via DI

Select whether a DI input to start the defrost cycle is to be used.

If not, this allows a defrost schedule to be attached to the "daily user interface".

Defrost stop

Select a defrost stop procedure. By time. / By S3 temperature. By S4 temperature

Defrost stop temp.

Value setting (-5 to 60)

Max. defrost time

Max. permitted defrost time Refrigeration will always start once this time has passed.

Drip delay

Time after defrost end, where the water is dripping from the refrigeration surfaces.

Defrost outputs

Select whether an output is to be activated during defrosting..

Comp.operation during defrost

Select whether the compressors are to run during defrosting.

Setup general alarm inputs

1. Go to Configuration menu

2. Select General alarm inputs

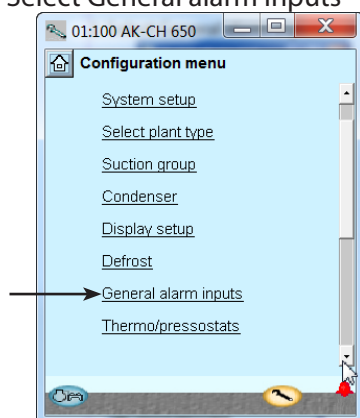

3. Define the required alarm functions

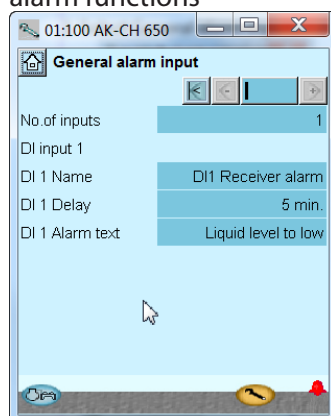

In our example we select one alarm function for monitoring the liquid level in the receiver. We have subsequently selected a name for the alarm function and for the alarm text.

3 - General alarm input

This function can be used to monitor all kinds of digital signals.

No. of inputs

Set the number of digital alarm inputs

Adjust for each input

- Name
- Delay time for DI alarm (common value for all)
- Alarm text

Setup separate thermostat functions

1. Go to Configuration menu

2. Select Thermostats

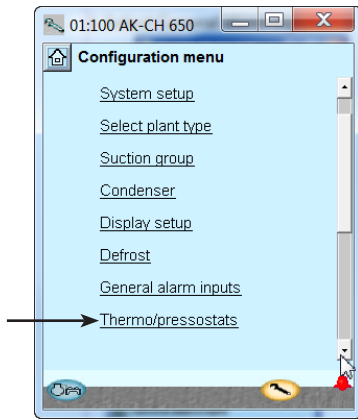

3. Define the required thermostat function

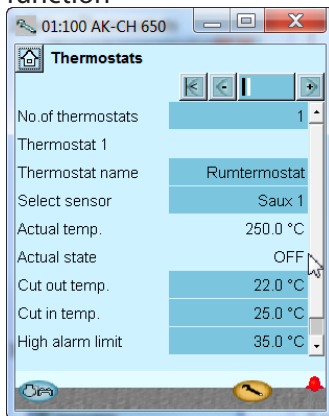

In our example we select one thermostat function for monitoring the plant room temperature.

We have subsequently entered a name for the function.



Via the +- button you can move to similar settings for the pressure control functions. (Not used in the example)

3 - Thermostats

The general thermostats can be used to monitor the temperature sensors that are used, as well as 4 extra temperature sensors. Each thermostat has a separate outlet to control external automation.

No. of thermostats

Set the number of general thermostats.

For each thermostat adjust

- Name
- Which of the sensors is used

Actual temp.

Temperature measurement on the sensor that is attached to the thermostat

Actual state

Actual status on the thermostat outlet

Cut out temp.

Cut-out value for the thermostat

Cut in temp.

Cut-in value for the thermostat

High alarm limit

High alarm limit

Alarm delay high

Time delay for high alarm

Alarm text high

Indicate alarm text for the high alarm

Low alarm limit

Low alarm limit

Alarm delay low

Time delay for low alarm

Alarm text low

Indicate alarm text for low alarm

3b - Pressostats

There are similar settings for up to 3 pressure switch functions.

Setup separate voltage functions

1. Go to Configuration menu

2. Select General Voltage inputs

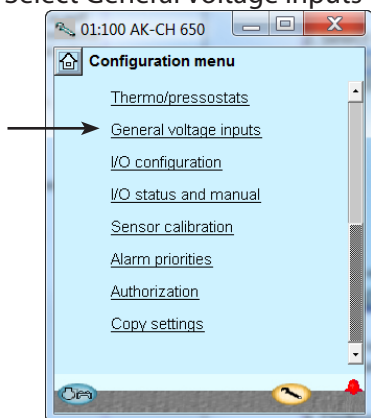

(In our example we do not use this function).

3. Define the required names and values attached to the signal

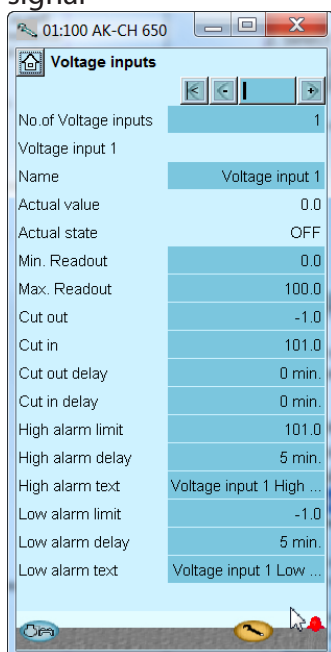

In our example we do not use this function, so the display has been included for your information only.

The name of the function may be xx and further down in the display the alarm texts may be entered.

The values "Min. and Max. Readout" are your settings representing the lower and upper values of the voltage range. 2V and 10V, for example. (The voltage range is selected during the I/O setup).

For each voltage input defined the controller will reserve a relay output in the I/O setup. It is not necessary to define this relay if all you require is an alarm message via the data communication.

3 - Voltage inputs

The general volt inlet can be used to monitor external voltage signals. Each volt inlet has a separate outlet to control external automatic controls.

No. of voltage inp.

Set the number of general voltage inputs, specify 1-5:

Name

Actual value

= read-out of the measurement

Actual state

= read-out of outlet status

Min. readout

State read-out values at minimum voltage signal

Max. readout

State read-out values at maximum voltage signal

Cutout

Cut-out value for outlet

Cutin

Cut-in value for outlet

Cutout delay

Time delay for cut-out

Cut in delay

Time delay for cut-in

Limit alarm high

High alarm limit

Alarm delay high

Time delay for high alarm

Alarm text high

Set alarm text for high alarm

Limit alarm low

Low alarm limit

Alarm delay low

Time delay for low alarm

Alarm text low

Indicate alarm text for low alarm

Configuration of inputs and outputs

1. Go to Configuration menu

2. Select I/O configuration

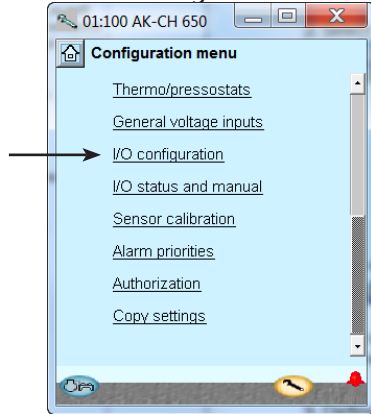

3. Configuration of Digital outputs

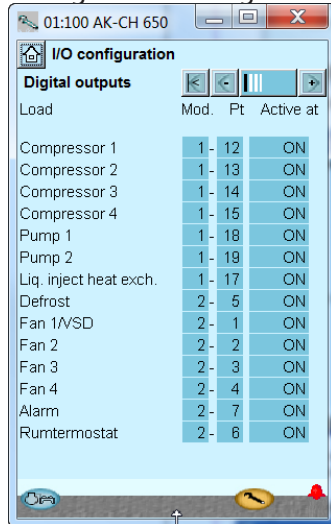

Press the +-button to go on to the next page

4. Setup On/off input functions

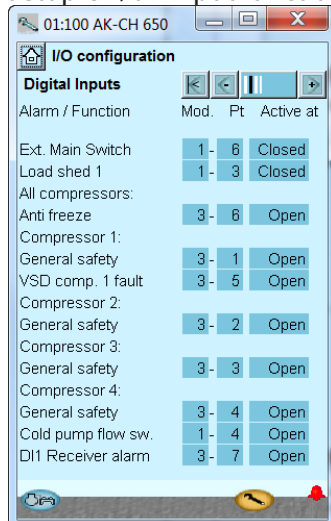

Press the +-button to go on to the next page

The following displays will depend on the earlier definitions. The displays will show which connections the earlier settings will require. The tables are the same as shown earlier.

- Digital outputs
- Digital inputs
- Analog outputs
- Analog inputs

Load	Output	Module	Point	Active at
Compressor 1 /VSD	DO1	1	12	ON
Compressor 2	DO2	1	13	ON
Compressor 3	DO3	1	14	ON
Compressor 4	DO4	1	15	ON
	DO5	1	16	
Liq.injec. in heat ex-changer	DO6	1	17	ON
Pump 1	DO7	1	18	ON
Pump 2	DO8	1	19	ON
Fan 1	DO1	2	1	ON
Fan 2	DO2	2	2	ON
Fan 3	DO3	2	3	ON
Fan 4	DO4	2	4	ON
Defrost	DO5	2	5	ON
Fan in plant room	DO6	2	6	ON
Alarm	DO7	2	7	OFF !!!
	DO8	2	8	

!!! The alarm is inverted so that there will be an alarm if the supply voltage to the controller fails.

We set up the controller's digital outputs by keying in which module and point on this module each one of these has been connected to. We furthermore select for each output whether the load is to be active when the output is in pos. **ON** or **OFF**.

Function	Input	Module	Point	Active at
Consumpt. limit	AI3	1	3	Closed
Pump flow switch	AI4	1	4	Open
External main switch	AI6	1	6	Closed
Compressor 1 Gen. Safety	DI1	3	1	Open
Compressor 2 Gen. Safety	DI2	3	2	Open
Compressor 3 Gen. Safety	DI3	3	3	Open
Compressor 4 Gen. Safety	DI4	3	4	Open
VSD, comp. speed	DI5	3	5	Open
Frost protection	DI6	3	6	Open
Receiver level on/off	DI7	3	7	Open

We set up the controller's digital input functions by keying in which module and point on this module each one of these has been connected to.

We furthermore select for each output whether the function is to be active when the output is in pos. **Closed** or **Open**. Open has been selected here for all the safety circuits. This means that the controller will receive signal under normal operation and register it as a fault if the signal is interrupted.

3 - Outputs

The possible functions are the following:

- Comp. 1
- Unloader 1-1, 1-2, 1-3
- Comp. 2-6
- Extra cooling
- Cold pump 1
- Cold pump 2
- Injec. in suction line
- Injec in heat exchanger
- Defrost
- Fan 1 /VSD
- Fan 2 - 8
- Heat recovery
- Alarm
- Thermostat 1 - 5
- Pressostat 1 - 5
- Voltage input 1 - 5

4 - Digital inputs

The possible functions are the following:

- Ext. Main switch
- Night setback
- Load shed 1
- Load shed 2
- Frost protection
- All compressors: Compressor. ___
- Oil pressure safety
- Over current safety
- Motor protect. safety
- Disch. temp. safety
- Disch. press. safety
- General safety
- VSD comp_ error 1-2
- Flow switch (cold pump)
- Cold pump 1 monitoring
- Cold pump 2 monitoring
- Fan 1 protection
- Fan 2.....8 protection
- VSD Cond. protection
- Heat recovery
- DI Alarm 1
- DI Alarm 2.....10
- Defrost

5. Configuration of Analog outputs

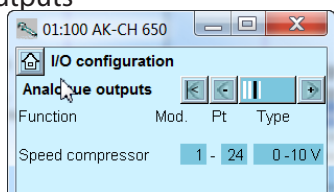

Press the + button to go on to the next page

Function	Output	Module	Point	Type
Speed control of compressor	AO1	1	24	0-10 V

We set up the analog outputs for control of the compressor speed.

- 5 - Analog outputs**
 The possible signals are the following:
 0 -10 V
 2 - 10 V
 0 -5 V
 1 - 5V
 Select for:
 • Speed control comp.
 • Speed control fans.
 • Show cutin compressor capacity

6. Configuration of Analog Input signals

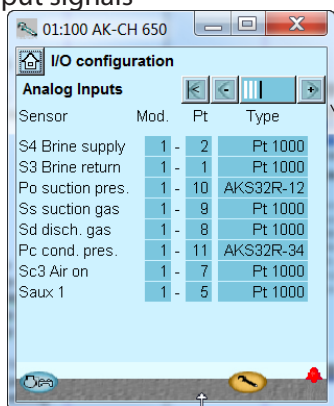

Sensor	Input	Module	Point	Type
Brine return temp. S3	AI1	1	1	Pt 1000
Brine supply temp. S4	AI2	1	2	Pt 1000
Thermostat sensor in plant room - Saux1	AI5	1	5	Pt 1000
Outdoor temp. - Sc3	AI7	1	7	Pt 1000
Disch. gas temperature - Sd	AI8	1	8	Pt 1000
Suction gas temperature - Ss	AI9	1	9	Pt 1000
Suction pressure - Po	AI10	1	10	AKS32-12
Condenser pressure - Pc	AI11	1	11	AKS32-34

We set up the analog inputs for the sensors.

- 6 - Analog inputs**
 The possible signals are the following:
 Temperature sensors:
 • Pt1000
 • PTC 1000
 Pressure transmitters:
 • AKS 32, -1 - 6 bar
 • AKS 32R, -1 - 6 Bar
 • AKS 32, - 1 - 9 Bar
 • AKS 32, - 1 - 9 Bar
 • AKS 32, - 1 - 12 Bar
 • AKS 32R, -1 - 12 Bar
 • AKS 32, - 1 - 20 Bar
 • AKS 32R, -1 - 20 Bar
 • AKS 32, - 1 - 34 Bar
 • AKS 32R, -1 - 34 Bar
 • AKS 32, - 1 - 50 Bar
 • AKS 32R, -1 - 50 Bar
 • AKS 2050, -1 - 59 Bar
 • AKS 2050, -1 - 99 Bar
 • AKS 2050, -1 - 159 Bar
 • User defined (only ratio-metric, min. and max value of the pressure range must be set)

- Voltage signals for reference displacement:
 • 0 - 5 V,
 • 0 -10 V

- S4 Brine supply
- S3 Brine return
- P0 suction pressure
- Ss suction gas
- Sd disch gas
- Pc cond. press.
- S7 warm brine
- Sc3 air on
- Ext. Ref. Signal
- Heat recovery
- Saux 1 - 4
- Paux 1 - 3
- Voltage input 1 - 5
- 0 -5 V,
- 0 -10 V,
- 1 - 5 V,
- 2 - 10 V

Set alarm priorities

1. Go to Configuration menu

2. Select Alarm priorities

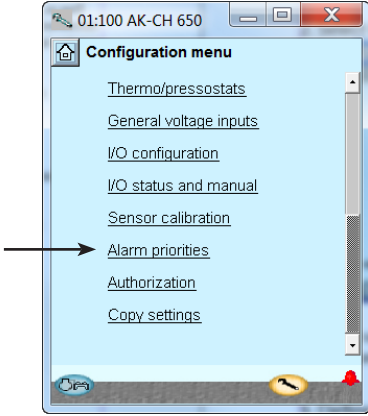

3. Set priorities for Suction group

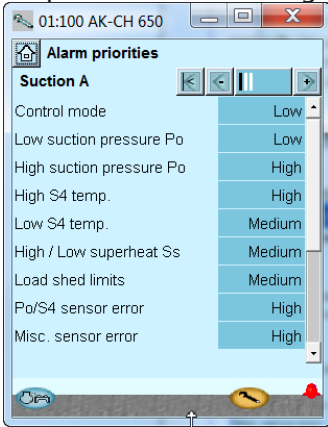

 Press the +-button to go on to the next page

4. Set alarm priorities for condenser

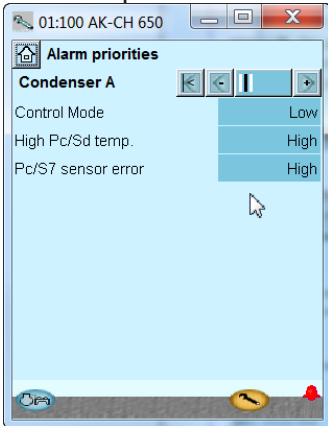

 Press the +-button to go on to the next page

Very many functions have an alarm connected.

Your choice of functions and settings has connected all the relevant alarms that are current. They will be shown with text in the three pictures.

All alarms that can occur can be set for a given order of priority:

- "High" is the most important one
- "Log only" has lowest priority
- "Disconnected" gives no action

The interdependence between setting and action can be seen in the table.

Setting	Log	Alarm relays selection			Net-work	AKM-dest.
		Non	High	Low - High		
High	X		X	X	X	1
Medium	X			X	X	2
Low	X			X	X	3
Log only	X					
Discon-nected						

See also alarm text

The first alarms for the suction groups are shown here. Further down in the display the priorities for the compressors' safety circuits are set.

In our example we select the settings shown here in the display

5. Set alarm priorities for thermostat and extra Digital signals

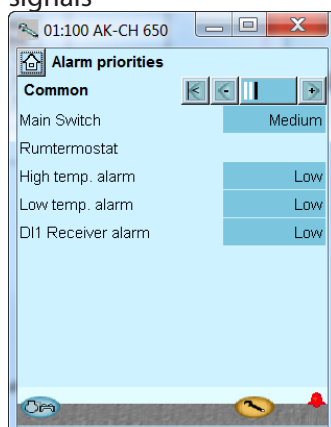

In our example we select the settings shown here in the display

Lock configuration

1. Go to Configuration menu

2. Select Lock/Unlock configuration

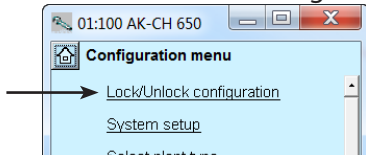

3. Lock Configuration

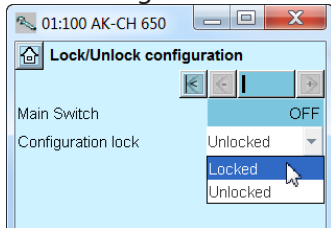

The controller will now make a comparison of selected functions and define inputs and outputs. The result can be seen in the next section where the setup is controlled.

Press in the field against **Configuration lock**.

Select **Locked**.

The setup of the controller has now been locked. If you subsequently want to make any changes in the controller's setup, remember first to unlock the configuration.

Check configuration

1. Go to Configuration menu

2. Select I/O configuration

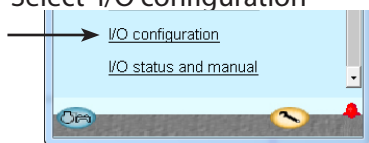

3. Check configuration of Digital Outputs

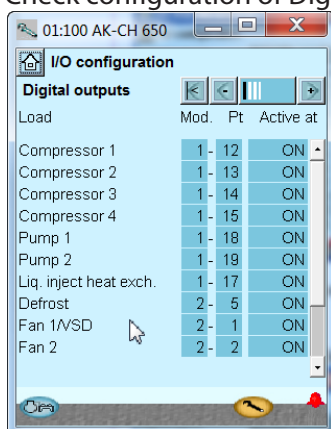

Press the +-button to go on to the next page

4. Check configuration of Digital Inputs

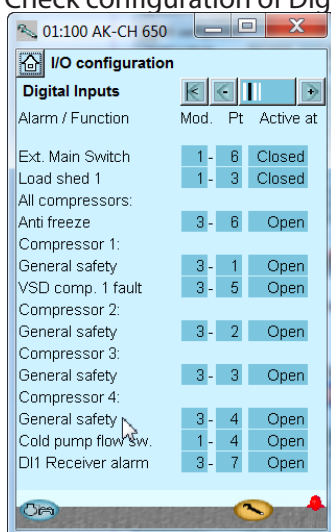

Press the +-button to go on to the next page

5. Check configuration of Analog Outputs

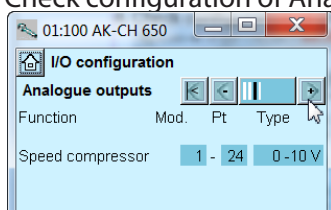

Press the +-button to go on to the next page

This control requires that the setup is locked

(All input and output settings only become active once the setup is locked.)

The setup of the digital outputs appears as it is supposed to according to the wiring made.

The setup of the digital inputs appears as it is supposed to according to the wiring made.

An error has occurred, if you see the following:



A **0 - 0** next to a defined function. If a setting has reverted to 0-0, you must control the setup again. This may be due to the following:

- A selection has been made of a combination of module number and point number that does not exist.
- The selected point number on the selected module had been set up for something different.

The error is corrected by setting up the output correctly.

Remember that the setup must be unlocked before you can change module and point numbers.



The settings are shown on a **RED** background. If a setting has turned red, you must control the setup again. This may be due to the following:

- The input or the output has been set up; but the setup has later been changed so that it should no longer be applied.

The problem is corrected by setting **module number to 0 and point number to 0.**

Remember that the setup must be unlocked before you can change module and point numbers.

6. Check configuration of Analog Inputs

Sensor	Mod.	Pt	Type
S4 Brine supply	1 -	2	Pt 1000
S3 Brine return	1 -	1	Pt 1000
Po suction pres.	1 -	10	AKS32R-12
Ss suction gas	1 -	9	Pt 1000
Sd disch. gas	1 -	8	Pt 1000
Pc cond. pres.	1 -	11	AKS32R-34
Sc3 Air on	1 -	7	Pt 1000
Saux 1	1 -	5	Pt 1000

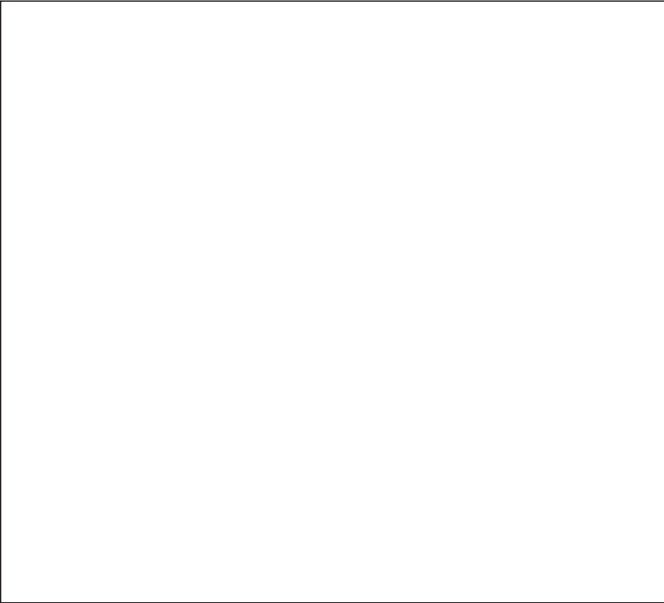

Check of connections

1. Go to Configuration menu

2. Select I/O status and manual

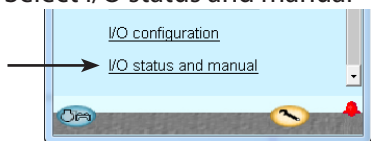

3. Check Digital Outputs

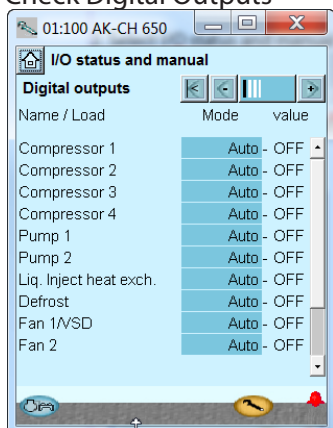

Press the +-button to go on to the next page

4. Check Digital Inputs

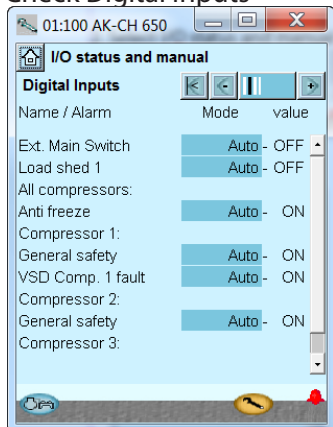

Press the +-button to go on to the next page

Before the control is started we check that all inputs and outputs have been connected as expected.

This controls requires that the setup is locked

By means of the manual control of each output it can be checked whether the output has been correctly connected.

AUTO The output is controlled by the controller

MAN OFF The output is forced to pos. OFF

MAN ON The output is forced to pos ON

Cut out the safety circuit for compressor 1.
 Check that LED DI1 on the extension module (module 3) goes out.
 Check that the value of the alarm for the safety monitoring of compressor 1 changes to **ON**.
 The remaining digital inputs are checked in the same way.

5. Check Analog outputs

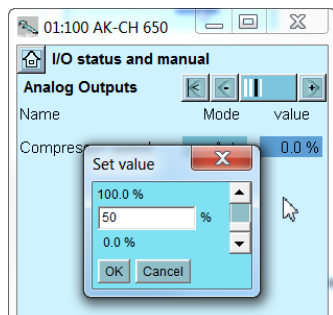
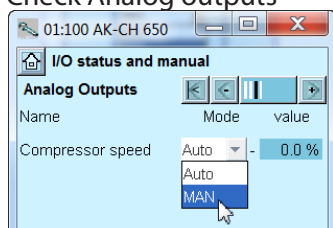

6. Put the control of the output voltage back to automatic

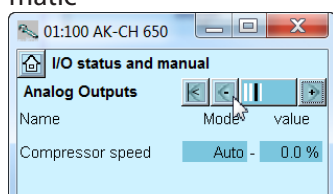

 Press the +-button to go on to the next page

7. Check Analog inputs

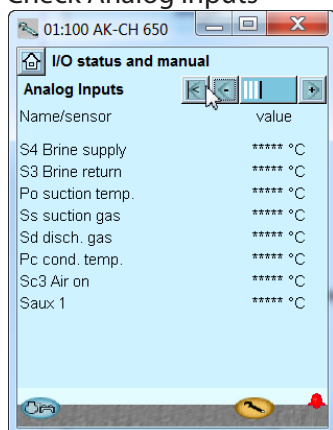

Set Control of output voltage to manual
Press in the **Mode** field.

Select **MAN**.

Press in the **Value** field
Select for example **50%**.

Press **OK**.

On the output you can now measure the expected value: In this example 5 volts

Example of the connection between a defined output signal and a manual set value.

Definition	Setting		
	0 %	50 %	100 %
0 - 10 V	0 V	5 V	10 V
1 - 10 V	1 V	5.5 V	10 V
0 - 5 V	0 V	2.5 V	5 V
2 - 5 V	2 V	3.5 V	5 V

Check that all sensors show sensible values.

In our case we have no value for the most sensors. This may be due to the following:

- The sensor has not been connected.
- The sensor is short-circuited.
- The point or module number has not been set up correctly.
- The configuration is not locked.

Check of settings

1. Go to the overview

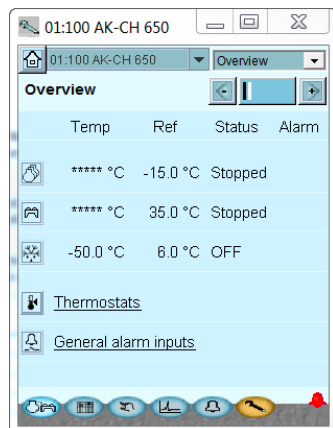

Before the control starts, we check that all the settings are as they should be.

The overview display will now show one line for each of the general functions. Behind each icon there is a number of displays with the different settings. It is all these settings that have to be checked.

2. Select suction group



3. Move on through all the individual displays for the suction group



Change displays with the +- button. Remember the settings at the bottom of the pages – the ones that can only be seen via the "Scroll bar".

4. Safety limits

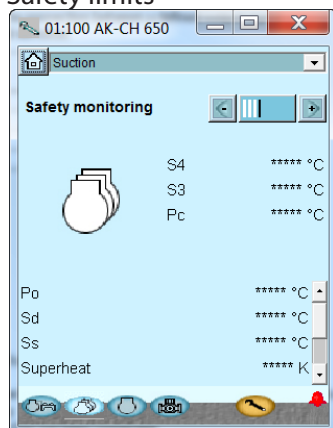

The last page contains safety limits and restart times.

5. Go back to the overview



6. Select condenser group



7. Move on through all the individual displays for the condenser group



Change displays with the +- button. Remember the settings at the bottom of the pages – the ones that can only be seen via the "Scroll bar".

8. Safety limits

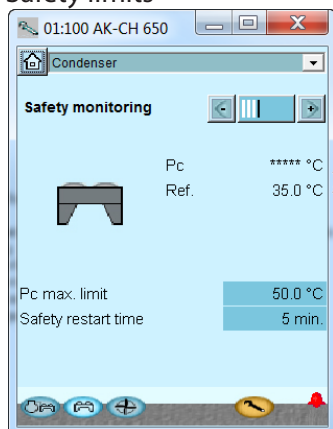

The last page contains safety limits and restart times.

9. Go back to the overview and Move on to the defrost function



Check the settings.

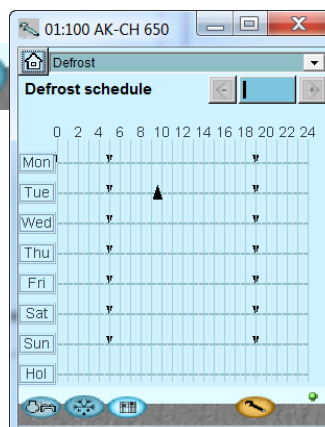

In the example, the defrost schedule has been set to two defrosts a day.

10. Go back to the overview and Move on to the thermostat group



Check the settings.

11. Go back to the overview and on to the general alarm inputs



Check the settings.

12. The controller setup has been completed.

Schedule function

1. Go to Configuration menu



2. Select schedule



3. Setup schedule

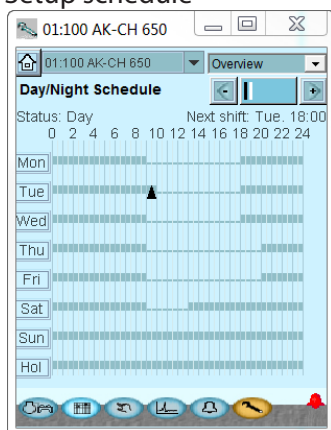

Before regulation is started we will set the schedule function for the night setback of the suction pressure.
 In other cases where the controller is installed in a network with one system unit, this setting may be made in the system unit which will then transmit a day/night signal to the controller.

Press a weekday and set the time for the day period.

Continue with the other days.

A complete weekly sequence is shown in the display.

Installation in network

1. Set the address (here, for example 3)

Turn the right-hand address switch so that the arrow will point at 3.

The arrow of the two other address switches must point at 0.

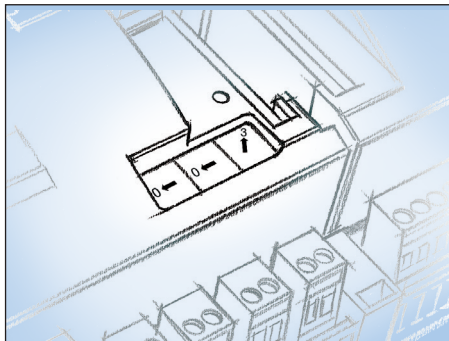

2. Push the Service Pin

Press down the service pin and keep it down until the Service Pin LED lights up.

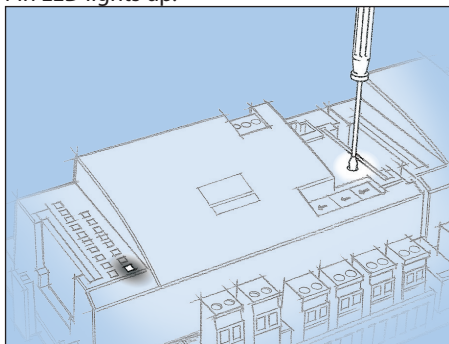

3. Wait for answer from the system unit

Depending on the size of the network it may be up to one minute before the controller receives an answer as to whether it has been installed in the network.

When it has been installed the Status LED will start to flash faster than normal (once every half second). It will continue with this for about 10 minutes

4. Carry out new login via Service Tool



If the Service Tool was connected to the controller while you installed it in the network, you must carry out a new login to the controller via the Service Tool.

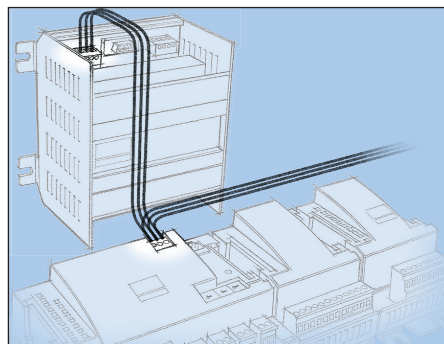

The controller has to be remote-monitored via a network. In this network we assign address number 3 to the controller.

The same address must not be used by more than one controller in the same network.

Requirement to the system unit

The system unit must be a gateway type AKA 245 with software version 6.0 or higher. It is capable of handling up to 119 AK controllers.

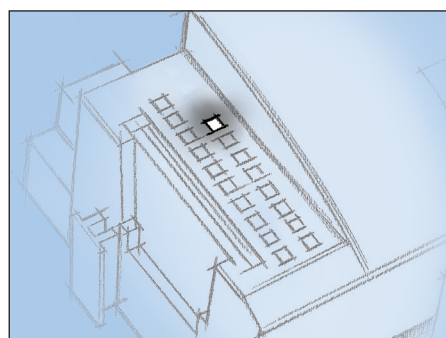

If there is no answer from the system unit

If the Status LED does not start flashing faster than normal, the controller has not been installed in the network. The reason for this may be one of the following:

The controller has been assigned an address out of range

Address 0 cannot be used.

If the system unit in the network is an AKA 243B Gateway only the addresses between 1 and 10 can be used.

The selected address is already being used by another controller or unit in the network:

The address setting must be changed to another (vacant) address.

The wiring has not been carried out correctly.

The termination has not been carried out correctly.

The data communication requirements are described in the document: "Data communication connections to ADAP-KOOL® Refrigeration Controls" RC8AC.

First start of control

Check alarms

1. Go to the overview



Press the blue overview button with the compressor and condenser at the bottom left of the display.

2. Go to the Alarm list



Press the blue button with the alarm bell at the bottom of the display.

3. Check active alarms

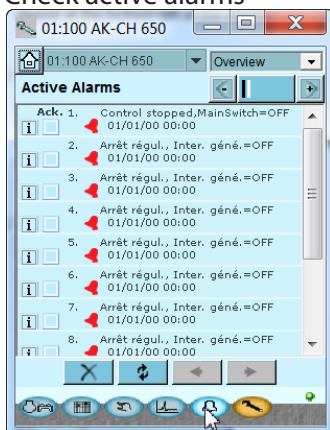

In our case, we have a series of alarms. We will tidy them up so that we only have those that are relevant.

4. Remove cancelled alarm from the alarm list



Press the cross to remove cancelled alarms from the alarm list.

5. Check active alarm again

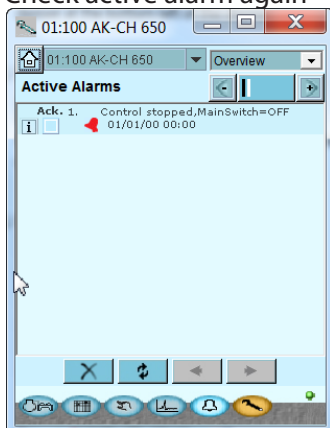

In our case an active alarm remains because the control has stopped. This alarm must be active when control has not started. We are now ready for the startup of control.

Please note that active plant alarms are automatically cancelled when the main switch is in pos. OFF. If active alarms appear when the control is started the reason for these should be found and remedied.

Start the control

1. Go to Start/Stop display



Press the blue manual control button at the bottom of the display.

2. Start control

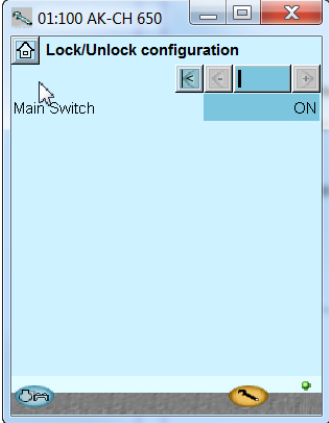

Press in the field against **Main switch**.
Select **ON**.
The controller will now start controlling the compressors and the fans.

Note:
Control does not start until both the internal and external switch are "ON".

Manual capacity control

1. Go to overview



2. Select suction group



Press the suction group button for the suction group that is to be controlled manually.



Press the + -button to go on to the next page

3. Set capacity control to manual

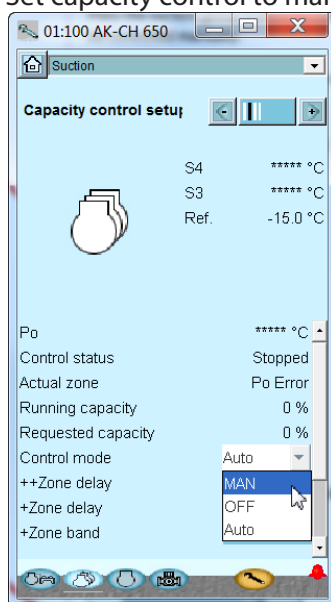

If you need to manually adjust the capacity of the compressors, you can use the following procedure:

Press the blue field against **Control mode**
Select **MAN**.

4. Set capacity in percent

Press in the blue field against **Manual capacity**.

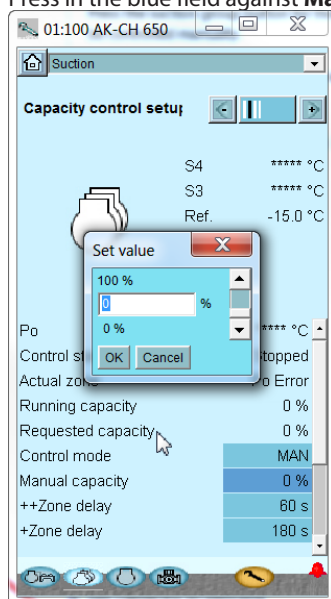

Set the capacity to the required percentage.
Press **OK**.

Manual defrost

1. Go to Configuration menu



2. Select defrost



3. Start defrost

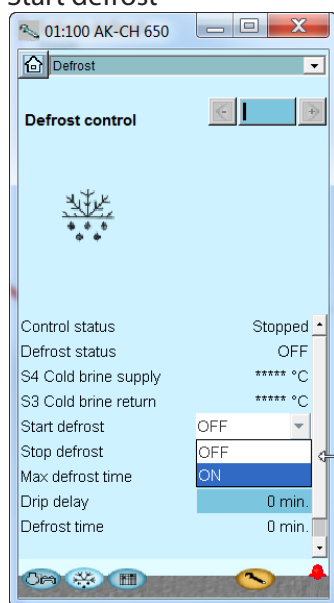

If you want to perform a manual defrost, this can be done via the following operation.

5. Regulating functions

This section describes how the different functions work

Suction group

Capacity control of compressors

PI-control and control zones

AK-CH 650 can control up to 6 compressors with up to 3 unloader valves each. One or two of the compressors can be equipped with speed regulation.

The calculation of the requested compressor capacity takes place on the basis of a PI control, but the set up is carried out in the same way as for a neutral zone controller which is divided into 5 different control zones as shown in below sketch.

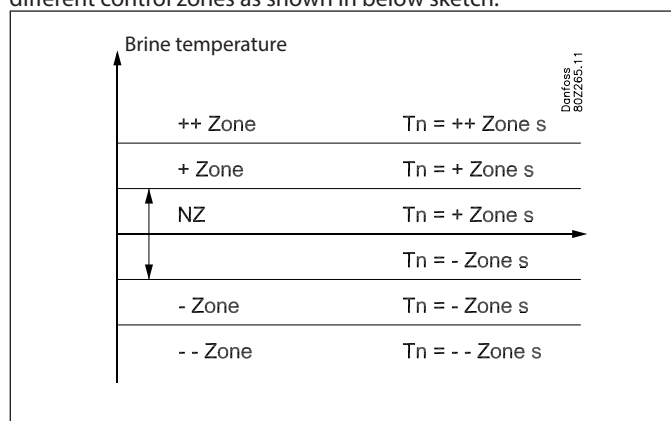

The width of some of the zones can be set via the settings "+ Zone K", "NZ K" and "- Zone K".

Furthermore it is possible to adjust zone timers which is equal to the T_n integration time for the PI controller whenever the suction pressure is in the zone in question (please see sketch above).

By setting a zone timer to a higher value will make the PI controller slower in this zone and by setting the zone timer lower will make the PI controller faster in this zone.

The amplification factor K_p is adjusted as parameter "Kp S4" In the neutral zone the controller is only allowed to increase or decrease the capacity by means of speed control and/or switching of unloader valves.

In the other zones the controller is also allowed to increase/decrease capacity by means of starting and stopping compressors.

The last compressor is only allowed to be stopped when the brine temperature is in the "- Zone" or "-- Zone"

At start-up the refrigeration system must have time to be stable before the PI controller takes over the control. For this purpose at start-up of a plant a limitation is made of the capacity so that only the first capacity step will cut in after a set period (to be set via "runtime first step").

Requested capacity

The readout "Requested capacity" is the output from the PI controller and it shows the actual requested compressor capacity by the PI controller. The rate of change in the requested capacity depends upon in which zone the brine temperature is and whether the brine temperature is stable or whether it is constantly changing.

The Integrator is looking at the deviation between the set point and the current temperature only and increases/reduces the requested capacity correspondingly. The amplification factor K_p on the other hand only looks at the temporary temperature changes.

In the "+ Zone" and "++ Zone" the controller will normally increase the requested capacity as the temperature is above the set point. But if the temperature is decreasing very fast the requested capacity might decrease also in these zones.

In the "- Zone" and "-- Zone" the controller will normally decrease the requested capacity as the temperature is below the set point. But if the temperature is increasing very fast the requested capacity might increase also in these zones.

Change capacity

The controller will cut in or cut out capacity based on these basic rules:

Increase capacity:

The capacity distributor will start extra compressor capacity as soon as the requested capacity has increased to a value, which allows the next compressor step to start. Referring to below example - a compressor step is added as soon as there is "Room" for this compressor step below the requested capacity curve.

Decrease capacity:

The capacity distributor will stop compressor capacity as soon as the requested capacity has decreased to a value, which allows the next compressor to stop. Referring to below example - a compressor step is stopped as soon as there is no more "Room" for this compressor step above the requested capacity curve.

Example:

4 compressor of equal size - The capacity curve will look like this

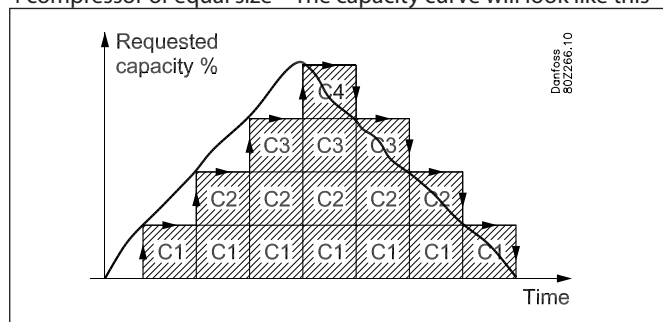

Cut-out of the last compressor stage:

Normally, the last compressor step will only be cut-out when the required capacity is 0% and the suction pressure is at "-Zone" or in "--Zone"

Reference for compressor control

Regulating sensor

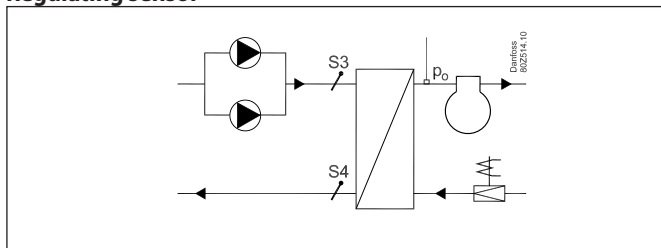

The regulating sensor can be set at P0 or S4.

By setting the regulating sensor to S4, the P0 sensor's signal will be used for frost protection monitoring (LP safety).

The S3 signal is used only for monitoring.

The Reference

The reference for the regulation can be defined in 2 ways:

Either

Ref = P0 setting + P0 optimisation + Night displacement
or

Ref = setting + night displacement + Ext. Ref + S3 offset

Setting

A basic value for the brine temperature is set.

P0 optimization

This function displaces the reference so that regulation will not take place with a lower brine temperature than required.

The function cooperates with controllers on the individual refrigeration appliances and network system manager. The system manager obtains data from the individual appliance sections and adapts the brine temperature to the optimum energy level. The function is described in the manual for the system manager.

With this function you can read which appliance is most heavily loaded at the moment as well as the displacement allowed for the brine temperature reference.

Night displacement

The function is used to change the suction pressure reference for night time operation as an energy saving function.

With this function the reference can be displaced by up to 25 K in positive or negative direction. (When you displace to a higher temperature, a positive value is set).

Displacement can be activated in three ways:

- Signal on an input
- From a system managers override function
- Internal time schedule

The "night displacement" function can not be used when regulation with the override function "P0-optimisation" is performed. (Here the override function will itself adapt the brine temperature to the max. permissible).

The function can be used if a short change in the brine temperature (e.g. up to 15 min.) is needed. Here the P0 optimisation will not be able to compensate for the modification.

Ext. Ref. - Override with a 0 - 10 V signal

When a voltage signal is connected to the controller the reference can be displaced. In the setup it is defined how big a displacement is to take place at max. signal (10 V).

S3 offset

With this function it is possible to delay the reference, based on a measured S3 temperature.

The sensor can be located, for example, in the return temperature of the brine or in the store premises. This allows a reference to be achieved that is adjusted to the current load. In the case of an error on the S3 sensor, the contribution to the reference is omitted.

The offset is calculated on the basis of the following expression:

S3 offset = K1 (S3 temp. – TrefS3Offset),
where K1 is a multiplication factor and "TrefS3Offset" is the S3 temperature that does not give reference offset.

For example:

- The reference temperature of the brine is to be offset based on the shop temperature
- At 18°C no reference offset is required, i.e. S3 ref = 18
- For each increase of 1°C in shop temperature, a reduction in reference of 0.5K is required, i.e. K1 = -0.5
- The contribution to the reference therefore becomes: -0.5 x ("S3 temp" - 18)

Limitation of reference

To safeguard yourself against a too high or too low regulation reference, a limitation of the reference must be set.

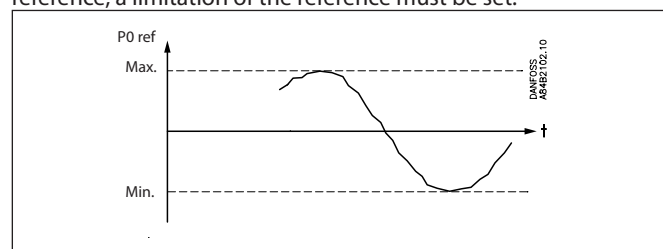

Forced operation of the compressor capacity in the suction group

A forced operation of the capacity can be carried out which disregards the normal regulation.

Depending on the selected form of forced operation, the safety functions will be cancelled.

Forced operation via overload of requested capacity

The control is set to manual and the desired capacity is set in % of the possible compressor capacity.

Forced operation via overload of digital outlets

The individual outputs can be set to MAN ON or MAN OFF in the software. The control function disregards this but an alarm is sent out that the outlet is being overridden.

Forced operation via change-over switches

If the forced operation is done with the switch-over on the front of an expansion model, this is not registered by the control function and no alarm is sounded. The controller continues to run and couples with the other relays.

Extra cooling

If the brine temperature increases more than desired, a function can be selected that will activate a relay. The function is activated if the set value is exceeded and the associated delay time has elapsed.

The temperature value is set as a maximum value that is higher than the reference (e.g. 4K above the reference).

There are two delay times. One is activated under normal regulation, and the other is longer and is only activated during the cooling down phases — during start-up — after defrosting.

Capacity distribution methods

The capacity distributor can work based on 3 distribution principles.

Coupling pattern – sequential operation:

The compressors are cut in and cut-out following the “First in, Last out” (FILO) principle in accordance with the sequence defined in the set-up.

Any speed-regulated compressors are used to close capacity gaps.

Timer restrictions

If a compressor is prevented from starting because it “hangs” on the re-start timer, this step is not replaced by another compressor but the step switch waits until the timer has lapsed.

Safety cutout

If on the other hand there is a safety switch on this compressor, this is excluded and the step switch immediately selects the following step in the sequence.

Coupling pattern – Cyclical operation:

This principle is used if all compressors are of the same type and size.

The compressor cuts-in and cuts-out in accordance with the “First In First Out” principle (FIFO) to equalise operating hours between the compressors.

Speed-regulated compressors will always be cut in first, and the variable capacity is used to fill capacity gaps between the subsequent steps.

Timer restrictions and safety cut outs

If a compressor is prevented from starting because it is “hanging” on the restart timer or is safety cut out, this step is replaced by another compressor.

Operating time equalisation

The operating hour equalizing is carried out between compressors of the same type with the same total capacity.

- At the different startups the compressor with the lowest number of operating hours will be started first.
- At the different stops the compressor with the highest number of operating hours will be stopped first.
- For compressors with several steps, the operating time equalizing is carried out between the compressors’ main steps.

Coupling pattern – Best fit operation

This principle is used if the compressors are of different sizes.

The capacity distributor will cut-in or cut-out the compressor capacity in order to ensure the least possible capacity jump. Speed-regulated compressors will always be cut in first, and the variable capacity will be used to fill capacity gaps between the subsequent steps.

Timer restrictions and safety cut outs

If a compressor is prevented from starting because it is “hanging” on the restart timer or is safety-cut out, this step is replaced by another compressor or another combination.

Minimum capacity change

To prevent the capacity distributor from selecting a new compressor combination (cut-out and cut-in compressors) due to a small change in capacity requirements, it is possible to set a minimum change in capacity requirement that will operate before the capacity distributor changes to a new compressor combination.

Power pack types – compressor combinations

The controller is able to control power packs with up to 6 compressors of various types:

- One or two speed controlled compressor
- Capacity controlled reciprocating compressors with up to 3 unloader valves
- Single step compressors – reciprocating or scroll

The chart below shows the compressor combination which the controller is capable of controlling. The chart also shows which coupling pattern can be set for the individual compressor combinations.

Combination	Description	Coupling pattern		
		Sequence	Cyclical	Best fit
	One-step compressors. *1	x	x	x
	A compressor with an unload valve, combined with one-step compressors. *2	x	x	
	Two compressors with unload valves, combined with one-step compressors. *2	x	x	
	All compressors with unload valves. *2	x	x	
	A speed-regulated compressor combined with one-step compressors. *1 and *3	x	x	x
	A speed-regulated compressor combined with several compressors with unload valves. *2 and *3	x	x	
	Two speed-regulated compressors combined with one-step compressors *4	x	x	x

*1) For a cyclical coupling pattern, the one-step compressors must be the same size.

*2) For compressors with unload valves, it is generally true that they must have the same size, the same number of unload valves (max 3) and the same sized main steps. If compressors with unload valves are combined with one-step compressors, all compressors should be the same size.

*3) Speed-regulated compressors can have different sizes in relation to subsequent compressors.

*4) When two speed-regulated compressors are used, they must have the same frequency range.

For cyclical coupling patterns, the two speed-regulated compressors should be the same size and the subsequent one-step compressors should also be the same size.

In appendix A there is a more detailed description of the coupling patterns for the individual compressor applications with associated examples.

The following is a description of some general rules for handling capacity-regulated compressors, speed-regulated compressors and also for two speed-regulated compressors.

Capacity-regulated compressors with unload valves

"Unloader control mode" determines how the capacity distributor should handle these compressors.

Unloader control mode = 1

Here the capacity distributor allows only one of the compressors to be unloaded at a time. The advantage of this setting is that it avoids operating with several compressors unloaded, which is not energy efficient.

For example:

Two capacity-regulated compressors of 20 kW, each with 2 unload valves, cyclical coupling pattern.

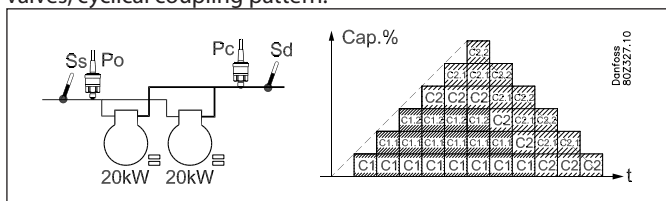

- For decreasing capacity, the compressor with the most operating hours is unloaded (C1).
- When C1 is completely unloaded, it is cut-out before compressor C2 is unloaded.

Unloader control mode = 2

Here the capacity distributor allows two compressors to be unloaded while capacity is decreasing. The advantage of this setting is it reduces the number of compressor start/stops.

For example:

Two capacity-regulated compressors of 20 kW, each with 2 unload valves, cyclical coupling pattern.

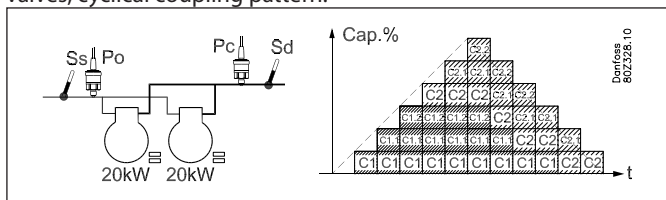

- For decreasing capacity, the compressor with the most operating hours is unloaded (C1).
- When C1 is completely unloaded, compressor C2 with one-step is unloaded before C1 is cut out.

Speed control compressors:

The controller is able to use speed control on the leading compressor in different compressor combinations. The variable part of the speed controlled compressor is used to fill in capacity gaps of the following compressor steps.

General regarding handling:

One of the defined capacity steps for the compressor regulation may be connected to a speed control unit that may be a frequency converter type AKD, for example.

An output is connected to the frequency converter's ON/OFF input and at the same time an analog output "AO" is connected to the frequency converter's analog input. The ON/OFF signal will start and stop the frequency converter and the analog signal will indicate the speed.

It is only the compressor defined as compressor 1 (1+2) that can be speed controlled.

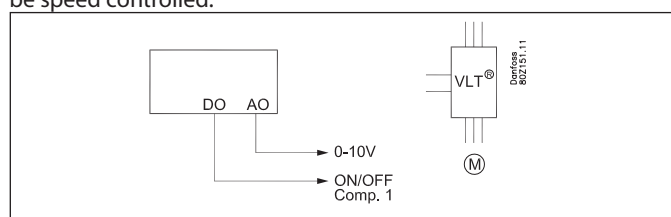

When the step is in operation it will consist of a fixed capacity and a variable capacity. The fixed capacity will be the one that corresponding to the mentioned min. speed and the variable one will lie between the min. and max. speed. To obtain the best regulation the variable capacity must be bigger than the subsequent capacity steps it has to cover during the regulation. If there are major short-term variations in the plant's capacity requirement it will increase the demand for variable capacity.

This is how you cut the step in and out:

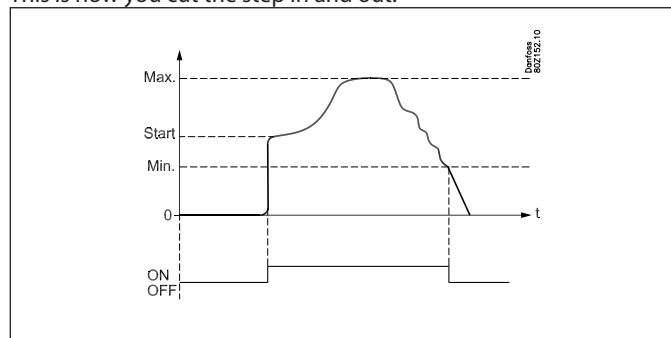

Cutin

The speed-controlled compressor will always be the first to start and the last to stop. The frequency converter will be started when a capacity requirement corresponding to the mentioned "Start speed" arises (the relay output changes to ON and the analog output is supplied with a voltage corresponding to this speed). It is now up to the frequency converter to bring the speed up to "Start speed".

The capacity step will now be cut in and the required capacity determined by the controller.

The start speed always ought to be set so high that a fast lubrication of the compressor is obtained during the start.

Controlling – increasing capacity

If the need for capacity becomes larger than "Max. Speed" then the subsequent compressor step will be cut-in. At the same time, the speed on the capacity step will be reduced so the capacity is reduced with a size that corresponds to exactly the cut-in compressor step. Thereby a completely "frictionless" transition is achieved without capacity holes (refer also to sketch).

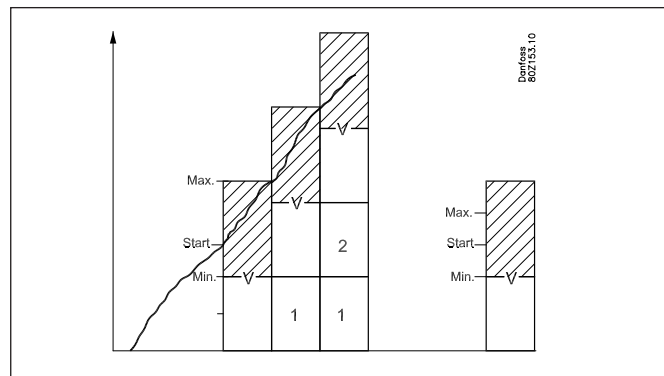

Controlling – decreasing capacity

If the capacity requirement becomes less than "Min. speed" then the subsequent compressor step will be cut-out. At the same time, the speed on the capacity step is increased so the capacity is increased with a size that corresponds to exactly the cut-out compressor step.

Cut-out

The capacity step will be cut-out when the compressor has reached "Min. Speed" and the requested capacity has dropped to 1%.

Timer restriction on speed controlled compressor

If a speed controlled compressor is not allowed to start due to a timer restriction, no other compressor is allowed to start. When the timer restriction has expired the speed controlled compressor will start.

Safety cutout on speed controlled compressor

If the speed controlled compressor is cutout on safety other compressors are allowed to start. As soon as the speed controlled compressor is ready to start it will be the first compressor to start.

As mentioned before the variable part of the speed capacity should be bigger than the capacity of the following compressor steps in order to achieve a capacity curve without "holes". In order to illustrate how the speed control will react at different pack combinations a couple of examples will be given here:

a) Variable capacity bigger than following compressor steps:

When the variable part of the speed controlled compressor is bigger than the following compressors there will be no "holes" in the capacity curve.

Example:

- 1 speed controlled compressor with a nominal capacity at 50Hz of 10kw - Variable speed range 30 – 90Hz
- 2 one step compressors of 10 kW

Fixed capacity = 30 HZ / 50 HZ x 10 kW = 6 kW

Variable capacity = 60 HZ / 50Hz x 10 kW = 12 kW

The capacity curve will look like this:

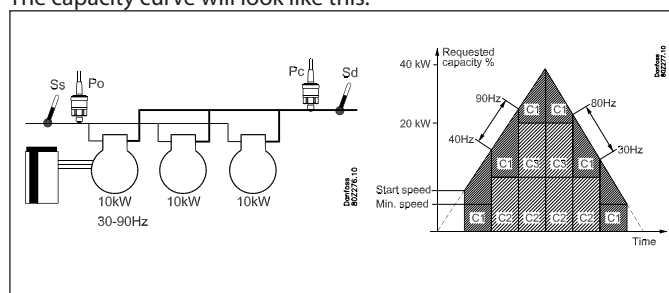

As the variable part of the speed controlled compressor is bigger than the following compressor steps, the capacity curve will be without holes.

- 1) The speed controlled compressor will be cut in when the requested capacity has reached the start speed capacity.
- 2) The speed controlled compressor will increase speed until it reaches max speed at a capacity of 18 kW.
- 3) The one step compressor C2 of 10 kW is cut in and the speed on C1 is reduced too so that it corresponds to 8kW (40Hz)
- 4) The speed controlled compressor will increase speed until the total capacity reaches 28 kW at max speed
- 5) The one step compressor C3 of 10kW is cut in and the speed on C1 is reduced too so that it corresponds to 8kW (40Hz)
- 6) The speed controlled compressor will increase speed until the total capacity reaches 38 kW at max speed
- 7) When reducing capacity the one step compressors will be cut out when the speed on C1 is at minimum

b) Variable part smaller than following compressor steps:

If the variable part of the speed controlled compressor is smaller than the following compressors there will be "holes" in the capacity curve.

Example:

- 1 speed controlled compressor with a nominal capacity at 50Hz of 20kw - Variable speed range 25 – 50Hz
- 2 one step compressors of 20 kW

Fixed capacity = 25 HZ / 50 HZ x 20 kW = 10 kW

Variable capacity = 25 HZ / 50Hz x 20 kW = 10 kW

The capacity curve will look like this:

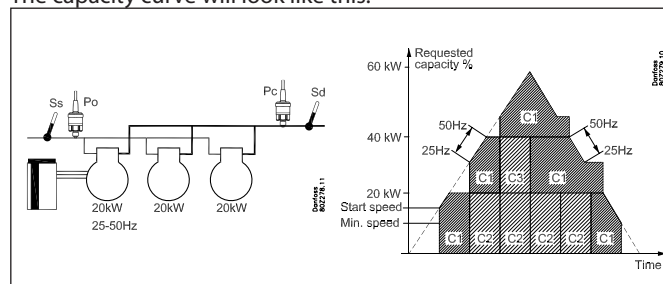

As the variable part of the speed controlled compressor is smaller than the following compressor steps the capacity curve will have some holes that can not be filled out by the variable capacity.

- 1) The speed controlled compressor will be cut in when the requested capacity has reached the start speed capacity.
- 2) The speed controlled compressor will increase speed until it reaches max speed at a capacity of 20 kW.
- 3) The speed controlled compressor will stay at max speed until the requested capacity has increased to 30 kW.
- 4) The one step compressor C2 of 20 kW is cut in and the speed on C1 is reduced to min. so that it corresponds to 10kW (25Hz). Total capacity = 30 kW.
- 5) The speed controlled compressor will increase speed until the total capacity reaches 40 kW at max speed
- 6) The speed controlled compressor will stay at max speed until the requested capacity has increased to 50 kW.
- 7) The one step compressor C3 of 20kW is cut in and the speed on C1 is reduced to min. so that it corresponds to 10kW (25Hz). Total capacity = 50 kW
- 8) The speed controlled compressor will increase speed until the total capacity reaches 60 kW at max speed
- 9) When reducing capacity the one step compressors will be cut out when the speed on C1 is at minimum speed

Two speed-regulated compressors

The controller is capable of regulating the speed of two compressors of the same or different sizes. The compressors can be combined with one-step compressors of the same or different sizes, depending on the choice of coupling pattern.

General regarding handling:

Generally, the two speed-regulated compressors are managed according to the same principle as for one speed-regulated compressor. The advantage of using two speed-regulated compressors is that it allows for a very low capacity, which is an advantage for low loads. At the same time, it produces a very large, variable regulating area.

Compressor 1 and 2 both have their own relay outlets to start/stop separate frequency converters, for example of type AKD. Both frequency converters use the same analog output signal AO which is connected to the frequency converters' analog signal input. The relay outputs will start and stop the frequency converter and the analog signal will indicate the speed.

The precondition for using this regulating method is that both compressors have the same frequency range.

The speed-regulated compressors will always be the first to start and the last to stop.

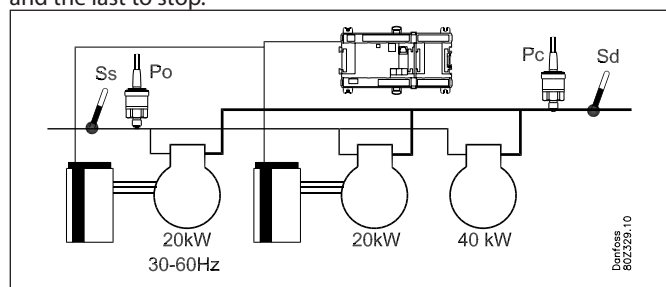

Cutin

The first speed-regulated compressor will be started when there is a capacity requirement which matches the setting.

The "Start speed" (relay outlet changes to on and the analog outlet is supplied with a voltage that matches this speed). It is now up to the frequency converter to bring the speed up to the "Start speed".

The capacity step will now be cut in and the desired capacity determined by the controller.

The start speed should always be set so high that a good lubrication of the compressor is quickly reached during start-up.

For a cyclical coupling pattern, the subsequent speed-regulated compressor will be cut in when the first compressor runs at max. speed and the desired capacity has reached a value that allows the cut-in of the next speed-regulated compressor at start speed. Afterwards, both compressors will be cut in together and will run in parallel. The following one-step compressors will be cut in and out in accordance with the selected coupling pattern.

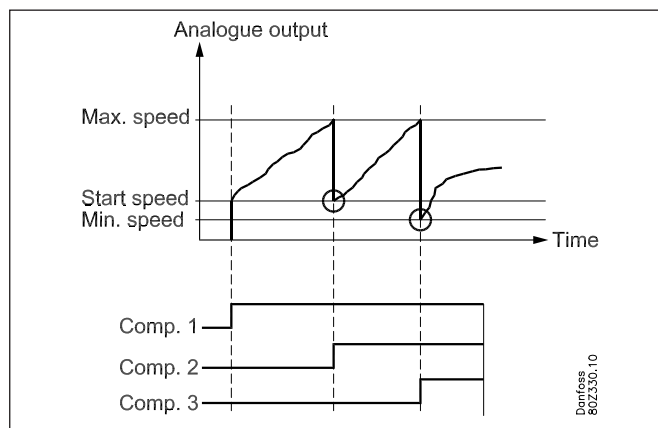

Controlling – decreasing capacity

The speed-regulated compressors will always be the last compressors running.

When the capacity requirement during cyclical operations becomes less than "Min. speed" for both compressors, the speed-regulated compressor with the most operating hours will be cut-out. At the same time, the speed of the last speed-regulated compressor increases so that the capacity is increased to the level that matches the cut-out compressor's step.

Cutout

The last speed-regulated compressor will be cut-out when the compressor has reached "Min. speed" and the capacity requirement (desired capacity) has decreased to under 1% (see however the section on the pump down function).

Timer restriction and safety cut-outs

Timer limits and safety cut-outs on speed-regulated compressors should be managed in accordance with the general rules for individual coupling patterns

Short descriptions and examples are given below of the handling of two speed-regulated compressors for the individual coupling patterns. For a more detailed description, refer to the appendix at the end of the chapter.

Sequential operation

During sequential operations, the first speed-regulated compressor will always start first. The following speed-regulated compressor will be cut in when the first compressor runs at max. speed and the desired capacity has reached a level that allows the cut-in of the next speed-regulated compressor at start speed. Afterwards, both compressors will be cut in together and they will run in parallel. The following one-step compressors will be cut in and out in accordance with The First-In-Last-Out principle.

Example:

- Two speed-regulated compressors with a nominal capacity of 20 kW and frequency range 25-60 Hz
- Two one-step compressors, each of 20 kW

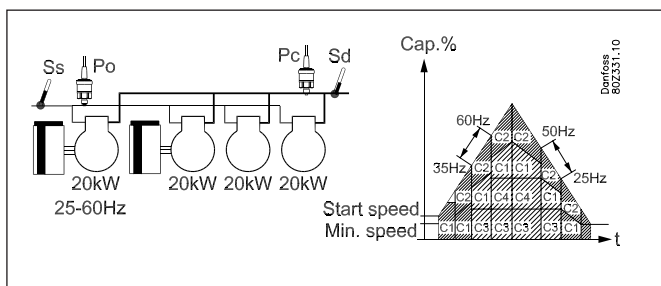

Cyclical operation

For cyclical operations, both speed-regulated compressors will have the same size and operating hours will be equalised between the compressors in accordance with the First-in-First-Out Principle (FIFO). The compressor with the least operating hours will be the first to start. The following speed-regulated compressor will be cut in when the first compressor runs at max. speed and the desired capacity has reached a value that allows the cut-in of the next speed-regulated compressor at start speed. Afterwards, both compressors will be cut in together and they will run in parallel. The following one-step compressors will be cut in and out in accordance with First-In-First-Out principle in order to equalise operating hours.

Example:

- Two speed-regulated compressors with a nominal capacity of 20 kW and frequency range 25-60 Hz
- Two one-step compressors, each of 20kW

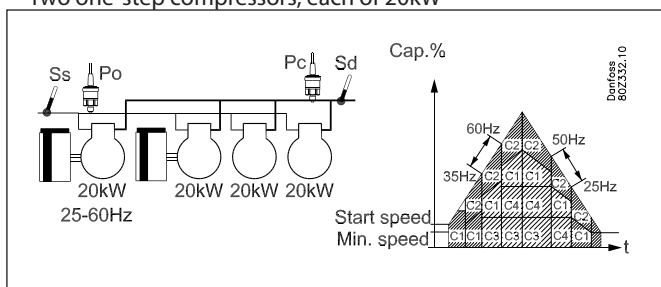

Best fit

During best-fit operations, the speed-regulated compressors can have different sizes and they will be handled in such a way that the best possible capacity adjustment is achieved. The smallest compressor will be started first, then the first will be cut-out and the second compressor will cut in. Finally, both compressors will be cut in together and will run in parallel.

The following one-step compressors will, in every case, be handled in accordance with the best-fit coupling pattern.

Example:

- Two speed-regulated compressors with a nominal capacity of 10 kW and 20 kW respectively
- Frequency range of 25- 60 Hz
- Two one-step compressors of 20 and 40 kW respectively

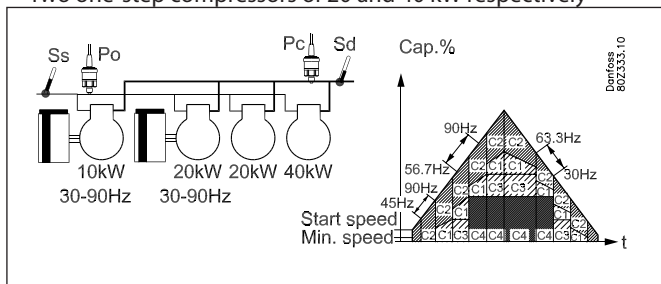

Compressor timers

Time delays for cutins and cutouts

To protect the compressor against frequent restarts three time delays can be put in.

- A minimum time to run from a compressor's startup and until it may be restarted.
- A minimum time (ON-time) for the compressor to operate before it may be stopped again.
- A minimum OFF time to run from a compressor stops and until it may be restarted

When unloaders are cut in and out, the time delays will not be used.

Timer

The operating time of a compressor motor is registered continuously. You can read out:

- operating time for the previous 24-hour period
- total operating time since the timer was last set to zero-set.

Coupling counter

The number of relay cutins and cutouts is registered continuously. The number of starts can be read out here:

- Number during the previous 24-hour period
- Total number since the counter was last set to zero-set.

Load shedding

On some installations there is the desire to limit the cut-in compressor capacity so that one can limit the total electrical load in the store for periods.

There are 1 or 2 digital inlets available for this purpose.

For each digital inlet a limit value is attached for the maximum allowable cut-in compressor capacity so that one can carry out the capacity limitation in 2 steps.

When a digital inlet is activated, the maximum allowable compressor capacity is limited to the set limit. This means that if the actual compressor capacity upon activation of the digital inlet is higher than this limit, then so much compressor capacity is cut-out that it will then be on or under the set maximum limit value for this digital inlet.

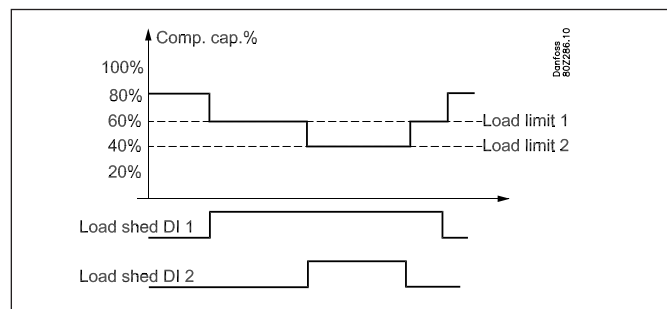

When both load-shedding signals are active, the lowest limit value for the capacity will be the one that is applicable.

Overriding of load shedding:

To avoid load shedding leading to temperature problems for the chilled products, an overriding function is fitted.

A overriding limit is set for the suction pressure as well as a delay time for each digital inlet.

If the suction pressure during load shedding exceeds the set overriding limit and the attached delay times for the two digital inlets expire then load shedding overrides the signals so that the compressor capacity can be increased until the suction pressure is again under the normal reference value. The load shedding can then be activated again.

Alarm:

When a load shedding digital inlet is activated, an alarm will be activated to inform that the normal control has been bypassed. This alarm can however be suppressed if so desired.

Heat exchanger injection

The controller can emit a start/stop signal for liquid injection in the heat exchanger.

The function can be connected with compressor operation in the following manner:

- Fluid injection is synchronised with compressor start/stop
Here the injection signal comes ON when the first compressor is started and goes OFF when the last compressor cuts out.
- Pump down on the last compressor
Here the injection signal will come ON when the first compressor is started.

When the required capacity has dropped to 0%, the injection signal goes OFF, but the last compressor remains running until suction pressure P_0 has reached a set pump down limit, after which it stops.

Liquid injection in suction line

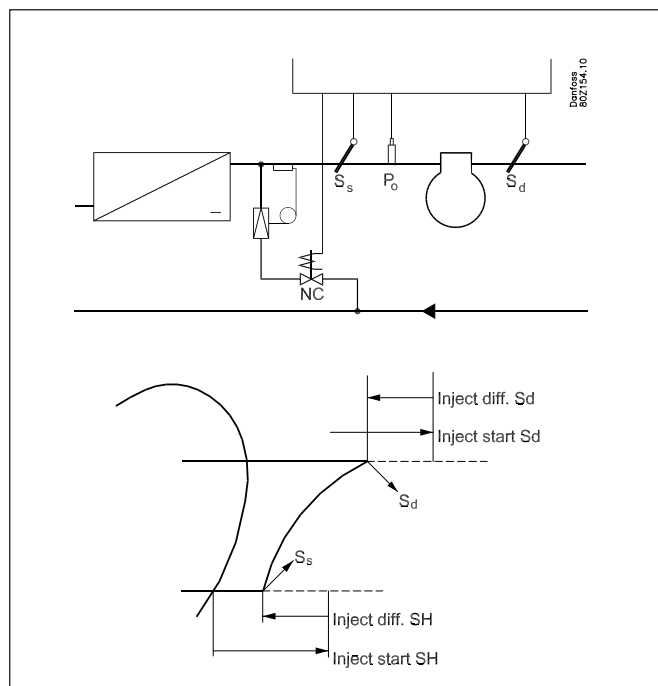

The high-pressure gas temperature can be kept down by means of liquid injection into the suction line.

The injection is accomplished with a thermostatic expansion valve in series with a solenoid valve. The solenoid valve is connected to the controller.

Control can be carried out in two ways:

1. The liquid injection is exclusively controlled on the basis of the superheat in the suction line. Two values are set – a starting value and a differential where the injection is stopped again.
2. The liquid injection is both controlled by the superheat (as described above) and by discharge temperature S_d . Four values are set – two as mentioned above and two for the S_d function, a starting value and a differential. The liquid injection is started when both starting values have been passed, and is stopped again when just one of the two functions SH cuts out.

Time delay

A time delay can be set which ensures that the injection is delayed during start up.

Defrost

The controller can perform a central defrost of the entire cold brine circuit.

When a defrost is commenced, the compressors stop (selectable), and the pumps continue to circulate the cold brine.

Defrost can be stopped by time, or when the cold brine has reached a set temperature.

After defrost has been stopped, it is possible to specify a drip delay time before the compressors restart.

There is the option for the defrost function to use an output for activation of external automatic controls.

Defrost start

Defrost can be started in several ways.

- Manual defrost
 - After activation, the setting automatically returns to OFF once defrost has been completed.
- External contact signal
 - Defrost start is performed with a signal on a DI input.
 - The signal must be a pulse signal of at least 3 seconds' duration.
 - Defrost starts when the signal changes from OFF to ON.
- Internal schedule
 - Defrost is started via a weekly program set in the controller.
 - The times are related to the controller's clock function. Up to 8 defrosts per day can be set.
- Network signal
 - Defrost can be started via a signal from the network (system manager).

Defrost stop

The following types of defrost stop can be selected:

Stop by temperature with time as security

Here the temperature of the cold brine is measured. Once the temperature is equal to the set stop temperature, defrost is stopped.

Stopping defrost by S4 or S3 temperature may be selected.

If the defrost time exceeds the set max. defrost time, defrost is stopped. This happens even if the temperature for defrost stop has not been reached. At the same time as defrost is stopped, the alarm message "Defrost time has been exceeded" is output. The alarm is automatically acknowledged after 5 min.

Stop by time

Here a permanent defrost time is set. Once this time has elapsed, defrost is stopped.

Manual stop

A defrost in progress can be stopped manually by activating the "Stop defrost" function.

Start after defrost

It is possible to input a drip delay after defrost, so that any water droplets can drip off the evaporators before refrigeration is restarted. This ensures that the evaporator is as free as possible of water on refrigeration restart.

Defrost output

It is possible to define a defrost output to control external automatic controls during defrost. The output will be activated during defrost itself, but deactivated during any drip delay that might be input.

Compressors

It is possible to define whether normal compressor capacity control is to be active during defrost or not.

Pumps

Pump control will always be active during defrost.

Status

It is possible to read off the following status values for defrost:

- Defrost status (ON/OFF)
- Current temp. at defrosting sensor
- Duration of defrost in progress or last completed defrost
- Average duration of the last 10 defrosts.

Safety functions

Signal from the compressor's safety controls

The controller can monitor the status of each compressor's safety circuit. The signal is taken directly from the safety circuit and connected to an input.

(The safety circuit must stop the compressor without involving the controller).

If the safety circuit is cut out the controller will cut out all output relays for the compressor in question and give an alarm.

Regulation will continue with the other compressors.

General safety circuit

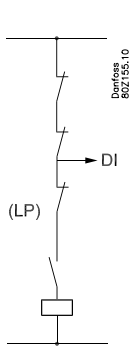

If a low-pressure switch is placed in the safety circuit it must be placed at the end of the circuit. It must not cut out the DI signals. (There is a risk that the regulation will become locked and that it will not start again). This also applies to the example below.

If an alarm is needed which also monitors the low-pressure thermostat, a "general alarm" can be defined (an alarm that does not affect the control). See the following section "General monitoring functions".

Extended safety circuit

Instead of a general monitoring of the safety circuit this monitoring function can be extended. In this way a detailed alarm message is issued which tells you which part of the safety circuit has dropped out.

The sequence of the safety circuit must be established as shown, but not all of them need necessarily be used.

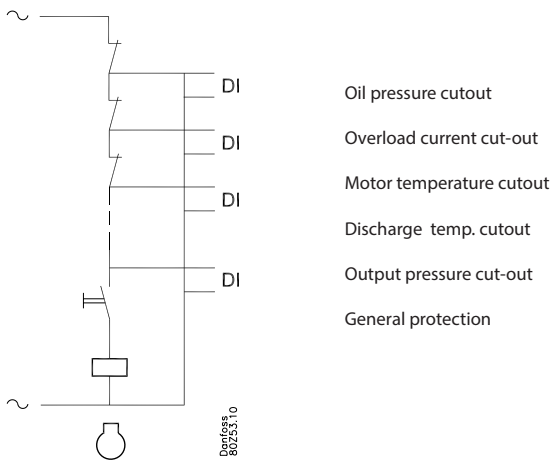

Common safety circuit

A common safety signal can also be received from the whole suction group. All compressors will be cut out when the safety signal cuts out.

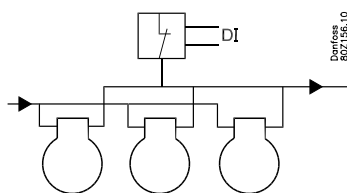

Time delays with safety cut-out:

In connection with safety monitoring of a compressor it is possible to define two delay times:

Cut-out delay time: Delay time from alarm signal from the safety circuit until the compressor outlet cuts out (note that the delay time is common to all security inlets for the compressor concerned)

Safety re-start time: The minimum time a compressor must be OK after a safety cut-out until it may start again.

Monitoring of superheat

This function is an alarm function which continuously receives measured data from suction pressure P0 and suction gas Ss. If superheat is registered which is lower or higher than the set limit values, an alarm will be given when the time delay has passed.

Monitoring of max. discharge gas temperature (Sd)

The function gradually cuts out compressor steps if the discharge temperature becomes higher than permitted. The cutout limit can be defined in the range from 0 to +195°C.

The function is started at a value that is 10 K below the set value. At this point the entire condenser capacity is cut in at the same time as 33% of the compressor capacity is cut out (but minimum one step). This is repeated every 30 seconds. The alarm function is activated.

If the temperature rises to the set limit value all compressor steps are immediately cut out.

The alarm is cancelled and renewed cutin of compressor steps is permitted when the following conditions are met:

- the temperature has dropped to 10 K below the limit value
- the time delay prior to restart has been passed. (see later)

Normal condenser control is permitted again when the temperature has dropped to 10 K below the limit value.

Monitoring of min. suction pressure (P0)

The function promptly cuts out all compressor steps if the suction pressure becomes lower than the permitted value.

The cutout limit can be defined in the range from -120 to +30°C.

The suction is measured with pressure transmitter P0.

At cutout the the alarm function is activated:

The alarm is cancelled and renewed cutin of compressor steps is permitted when the following conditions are met:

- the pressure (temperature) is above the cutout limit
- the time delay has elapsed (see later).

(On startup of the first compressor it is possible to delay the function so that cut-out can be avoided.)

Monitoring of max. condensing pressure (Pc)

The function cuts in all condenser steps and cuts out compressor steps one by one if the condensing pressure becomes higher than permitted. The cutout limit can be defined in the range from -30 to +100°C.

The condensing pressure is measured with pressure transmitter Pc.

The function takes effect at a value which is 3 K below the set value. At this time the entire condenser capacity is cut in at the same time as 33% of the compressor capacity is cut out (but min. one step). This is repeated every 30 seconds. The alarm function is activated.

If the temperature (pressure) rises to the set limit value, the following will happen:

- all compressor steps will immediately be cut out
- the condenser capacity will remain cut in

The alarm will be cancelled and renewed cut-in of compressor steps is permitted when the following conditions are met:

- the temperature (pressure) falls to 3 K below the limit value
- the time delay for restart has been passed.

Time delay

There is a joint time delay for "Monitoring of max. discharge gas temperature" and "Min. suction pressure".

After a cutout, regulation cannot be recommenced until the time delay has been passed.

The time delay starts when the Sd temperature has again dropped to 10 K below the limit value or P0 has risen above the P0 min. value.

Frost-proofing input

A digital input can receive a signal from an external frost-proofing signal.

If the frost-proofing signal is activated, the entire compressor capacity is disengaged and pump operation continues.

Re-engagement of the compressors is not permitted as long as the frost-proofing signal is active.

Startup procedure

The controller contains functions that ensure the proper interaction of pumps, compressors and injection on startup.

Pumps

On startup, the pumps must accelerate a large brine mass to normal flow rate before the compressors are allowed to start.

In the controller there is an adjustable delay time, "Comp. Wait s", which must expire before the first compressor can start.

Capacity limit

If too much compressor capacity is connected in the startup situation, there is a risk that the compressors will drop out at low pressure.

To prevent this situation, a capacity limit is input on startup of the system, so only the first capacity step is engaged in a set time period (set via "operation time first step").

Delay on P0 min cut-out

As further protection against cut-out at low pressure during startup, it is possible to delay the "P0 Min" cut-out.

The delay time can be set via "P0 Min. fors".

S4 Alarm thermostat

The function is used to emit an alarm if the S4 brine temperature becomes critical.

Alarm limits and delay times can be set for high and low temperature.

An alarm is emitted if the set limit is exceeded, but only after the delay time has expired.

There are no alarms when refrigeration has been stopped due to the main switch being set to Off.

Alarm limits

The alarm limits for high and low S4 temperature are set as absolute values in °C.

The alarm limits are not affected during night operation or on external reference displacement via a voltage signal.

Time delays

Three time delays are set:

- At too low a temperature
- At too high a temperature during normal control
- At too high a temperature during pull-down
 - After activation of an internal or external main switch
 - During defrosting
 - After a power failure

The time delay during pull-down applies until the S4 temperature drops below the upper alarm limit

S4 status information

To be able to assess how well the system is operating, the following can be read:

- Min, Max and average S4 temperature for the last 24 hours
- Operation time outside alarm limits within the last 24 hours, as a percentage

Example

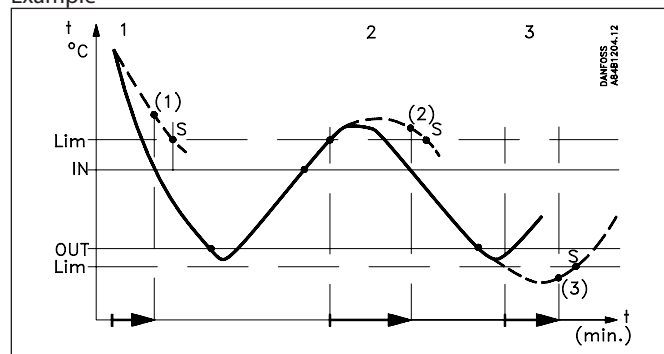

Curve 1: Pull-down phase

(1): The time delay is passed. The alarm becomes active.

Curve 2: Normal control where the temperature becomes too high

(2): The time delay is passed. The alarm becomes active.

Curve 3: The temperature becomes too low

(3): The time delay is passed. The alarm becomes active.

Pump control

The controller can control and monitor one or two pumps that circulate the brine.

If two pumps are used, and operating time equalisation is selected, the controller can also perform a changeover between the two pumps if operating alarms occur.

Activity in the case of operating alarm

Pump selection is performed using the following setting:

0: Both pumps are stopped

1: Pump 1 is started up

2: Pump 2 is started up

3: Both pumps are started up

4: Automatic changeover between the pumps is permitted. Start before stop.

5: Automatic changeover between the pumps is permitted. Stop before start.

(This function is used when both pumps are controlled in shifts by the same frequency converter.)

Automatic changeover between the pumps (only for setting = 4 and 5)

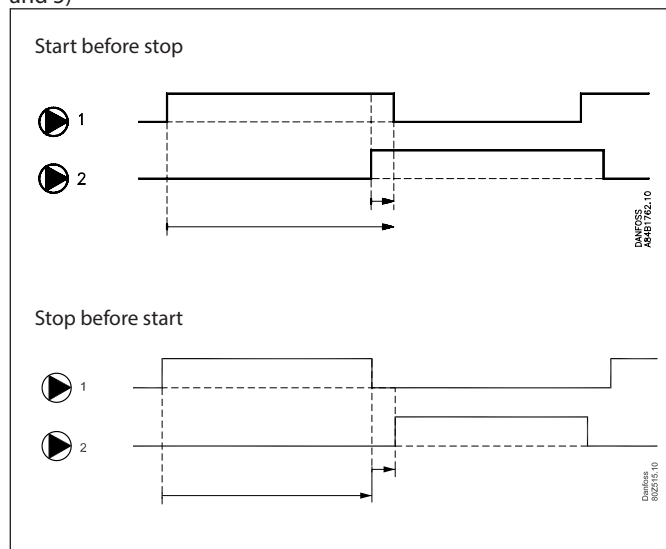

Using this setting there can be alternation between the two pumps so that a type of operating time equalisation is achieved. The period between the pump changeovers can be set as "PumpCycle". On changeover to the second pump, the first one will remain in operation for the "PumpDel" time. It will then stop. At stop before start "PumpDel" will be the break time for changeover.

Pump monitoring

The controller monitors pump operation via one or two safety input.

At one signal the setting "Common" is selected, and the signal can originate from a pressure difference pressure switch or a flow switch.

At two signals the setting "Individual" is selected. The two signals must then be received at two digital inputs. The signals may be retrieved from the two motor protectors.

Here too, set an alarm delay time that applies during startup and on pump changeover.

The delay time is to ensure that on startup/pump changeover, no error is signalled for a pump before brine flow has been established.

The special case of operating time equalisation

If the pumps are running with automatic operating time equalisation, the controller can perform a changeover of the pumps in a case where there is no flow.

Depending on whether pump changeover neutralises the alarm situation or not, the following occurs:

1) Pump changeover neutralises the alarm situation before the alarm delay expires.

If pump changeover neutralises the alarm situation, the non-faulty pump, now in operation, will run until the normal cycle time has expired. After that, there is changeover again to the "faulty pump", as it is assumed to have been repaired. At the same time, the alarm situation is reset (the alarm is acknowledged).

If the faulty pump has not been repaired, this will still trigger an alarm and still result in changeover to the pump that is not faulty. This is repeated until conditions are returned to normal.

2) Pump changeover does **not** neutralise the alarm situation before the alarm delay expires.

If the alarm, on the other hand, is active after pump changeover, the controller will also emit an alarm for the second pump. At the same time, both pump outputs are activated in an attempt to create enough flow for the alarm situation to be neutralised. From now on, the controller will have both pump outputs activated until the normal cycle time has expired, after which the alarm situation is reset and pump changeover to one pump is performed again.

Separate alarm priorities can be set for drop out of one pump and for drop out of both pumps. See the Alarms and Messages section.

Alarm handling

Pump alarms are suppressed/acknowledged when normal pump changeover is performed after the cycle time has expired.

Pump alarms can also be suppressed by setting pump selection to the "faulty" pump - if the flow switch is OK, the alarm will be acknowledged/suppressed as a result.

Condenser

Capacity control of the condenser can be accomplished via step regulation or speed control of the fans.

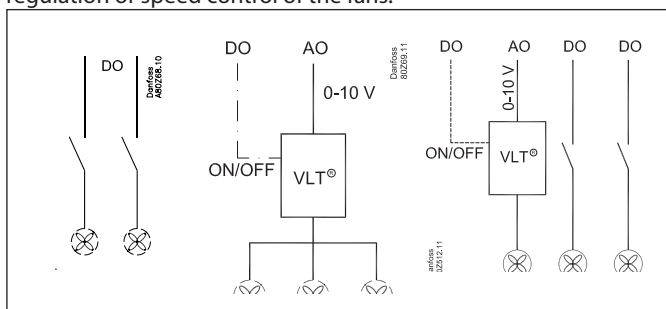

- **Step regulation**
The controller can control up to 8 condenser steps that are cut in and out sequentially.
- **Speed control**
The analog output voltage is connected to a speed control. All fans will now be controlled from 0 to max. capacity. If an ON/OFF signal is required it can be obtained from a relay output. Regulation can be carried out based on one of the following principles:
 - all fans operate at the same speed
 - Only the necessary number of fans is cut in.
 - Combination with one fan speed regulated and the rest step regulated

Capacity control of condenser

The cut-in condenser capacity is controlled by the condenser pressure's actual value and depends on whether the pressure is rising or falling. Regulation is performed by a PI controller which may however be changed into a P controller if the design of the plant necessitates this.

PI regulation

The controller cuts in capacity in such a way that the deviation between the actual condensing pressure and the reference value becomes as small as possible.

P regulation

The controller cuts in capacity that depends on the deviation between the actual condensing pressure and the reference value. The proportional band X_p indicates the deviation at 100% condenser capacity.

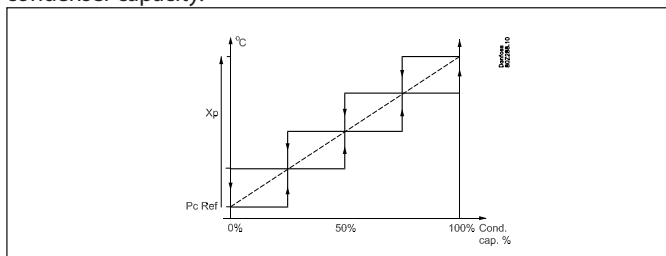

Capacity curve

On air-cooled condensers, the first capacity step will always give comparatively more capacity than the subsequent capacity steps. The increase in capacity produced by each extra step decreases gradually as more and more steps are cut in.

This means that the capacity controller requires more amplification at high capacities than at low capacities. Consequently, the

capacity controller for condenser regulation functions with an arc-shaped capacity curve so that amplification is optimal at both high and low capacities.

On some units, compensation is already made for the "problem" described above, by binary connection of the condenser fans: i.e. a few fans are connected at low capacity and many fans at high capacity, for example 1-2-4-8 etc. In this case, the non-linear amplification is already compensated for, and there is no need for an arc-shaped capacity curve.

It is therefore possible to choose on the controller whether you require an arc-shaped or a linear capacity curve to manage the condenser capacity.

Capacity curve = Linear / Power

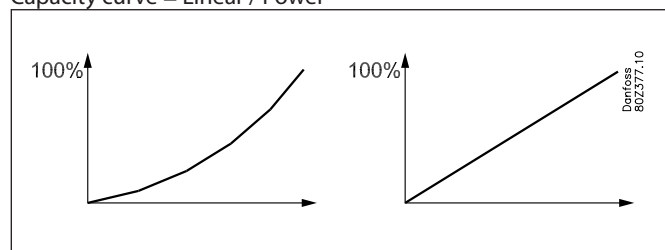

Capacity curve = Power

Capacity curve = Linear

Regulating sensor selection

The capacity distributor can either regulate from the condenser pressure PC or from the average temperature S7.

Cap. Ctrl sensor = Pc / S7

If the regulation sensor is selected for media temperature S7, then Pc is still used as the safety function for high condenser pressure and will therefore ensure cut-out of the compressor capacity when condenser pressure is too high.

Handling sensor errors:

Cap. Ctrl. Sensor = Pc

If Pc is used as the regulation sensor, an error in the signal will result in a cut-in of 100% condenser capacity, but the compressor regulation will remain normal.

Cap Ctrl. Sensor = S7

If S7 is used as the regulation sensor, an error in this sensor will result in further regulation that follows the Pc signal, but in accordance with a reference that is 5K over the actual reference. If there is an error on both S7 and Pc, 100% condenser capacity cuts-in, but the compressor regulation remains normal.

Reference for condensing pressure

The reference for the regulation can be defined in two ways. Either as a fixed reference or as a reference that varies according to the outdoor temperature.

Fixed reference

The reference for the condensing pressure is set in °C.

Floating reference

This function allows the condensing pressure's reference value to vary according to the outdoor temperature within a defined area.

PI regulation

The reference is based on:

- the outdoor temperature measured with Sc3 sensor
- The minimum temperature difference between the air temperature and the condensing temperature at 0% compressor capacity.
- the condenser's dimensioned temperature difference between the air temperature and the condensing temperature at 100% compressor capacity (Dim tmK)
- how large a part of the compressor capacity has been cut in.

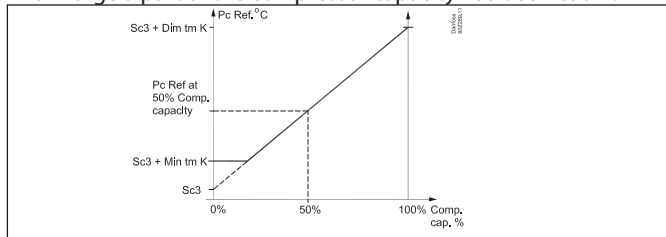

The minimum temperature difference (min tm) at low load should be set at approximately 6 K as this will eliminate the risk that all fans will be running when no compressors are running. Set the dimensioned difference (dim tm) at max. load (e.g. 15 K).

The controller will now contribute with a value to the reference which depends on how large a part of the compressor capacity has been cut in.

P-regulation

With P regulation the reference will be three degrees above the measured outdoor temperature. The proportional band Xp indicates the deviation with 100% condenser capacity.

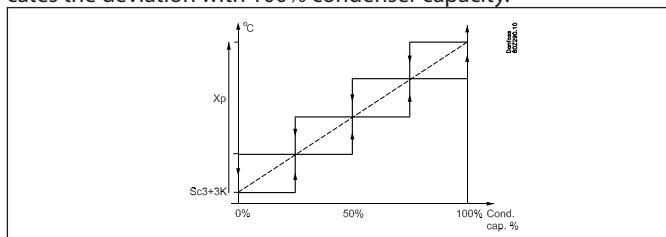

Heat recovery function

The heat recovery function can be used on the installation when you want to make use of warm gas for heating purposes. When the function is activated the reference for the condenser temperature will be raised to a set value and the attached relay outlet is used to activate a solenoid valve.

The function can be activated in two ways:

1. A digital input signal is received

In this instance, the heat recovery function is activated via an external signal from, for example a building management system. When the function is activated the reference for the condenser temperature will be raised to a set value and the

attached relay outlet is used to activate a solenoid valve.

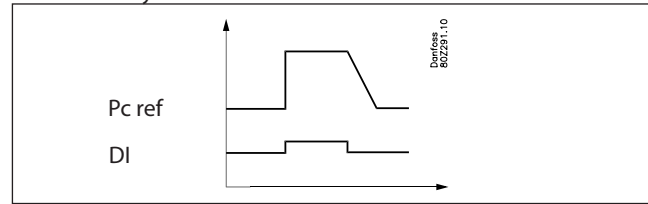

2. Use of a thermostat for the function.

This function can be used with advantage where the heat recovery is used to warm up a water tank. A temperature sensor is used to activate/deactivate the heat recovery function. When the temperature sensor becomes lower than the set cut in limit, the heat recovery function is activated and the reference for the condenser temperature will be raised to a set value and simultaneously the chosen relay outlet is used to activate a solenoid valve which leads the warm gas through the heat exchanger in the water tank. When the temperature in the tank has reached the set value, the heat recovery is cut-out again.

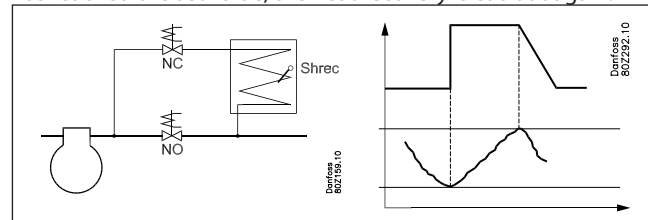

In both cases it applies that when the heat recovery function is de-activated, the reference for the condensing temperature will then decline slowly in accordance with the set rate in Kelvin/minute.

Limitation of the reference

To safeguard yourself against a too high or too low regulation reference, a limitation of the reference must be set.

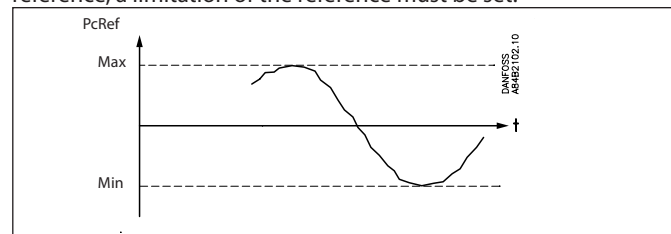

Forced operation of condenser capacity

Forced operation of the capacity can be arranged where the normal regulation is ignored.

The safety functions are cancelled during forced operation.

Forced operation via setting

The regulation is set to Manual.

The capacity is set in percent of the regulated capacity.

Forced operation of relays

If the forced operation is carried out with the switches at the front of an extension module, the safety function will register any exceeding of values and transmit alarms, if required, but the controller cannot cut the relays in or out in this situation.

Capacity distribution

Step regulation

Cut-ins and cutouts are carried out sequentially. The last cut-in unit will be cut out first.

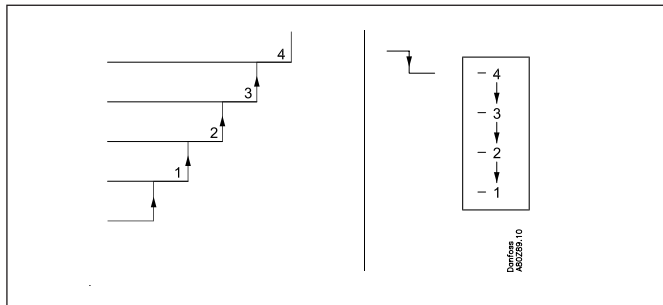

Speed regulation

When an analog output is used the fans can be speed regulated, e.g. with a frequency converter type AKD.

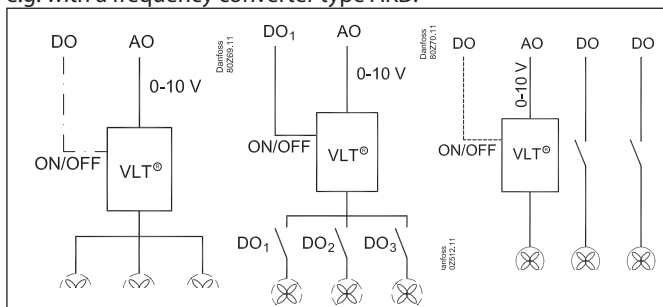

Joint speed regulation

The analog output voltage is connected to the speed regulation. All fans will now be regulated from 0 to max. capacity. If an ON/OFF signal is required for the frequency converter, so that the fans can be stopped completely, a relay output can be defined.

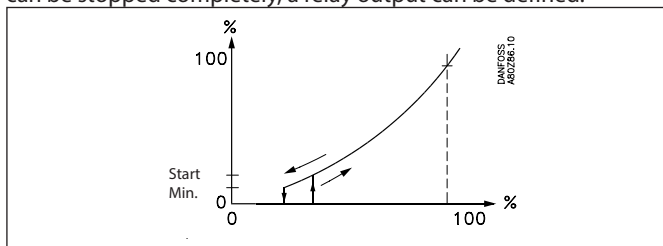

The controller starts the frequency converter when the capacity requirement corresponds to the set starting speed. The controller stops the frequency converter when the capacity requirement becomes lower than the set minimum speed.

Speed regulation + step regulation

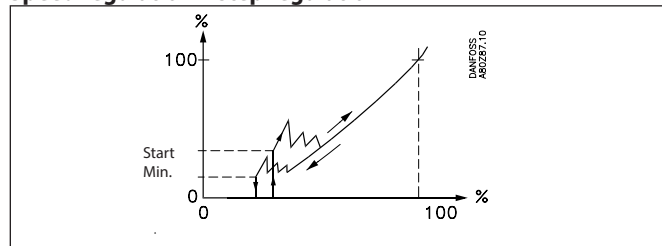

The controller starts the frequency converter and the first fan when the capacity requirement corresponds to the set starting speed.

The controller cuts in several fans step by step as the capacity requirement grows and then adapts the speed to the new situation.

The controller cuts out fans when the capacity requirement becomes lower than the set minimum speed.

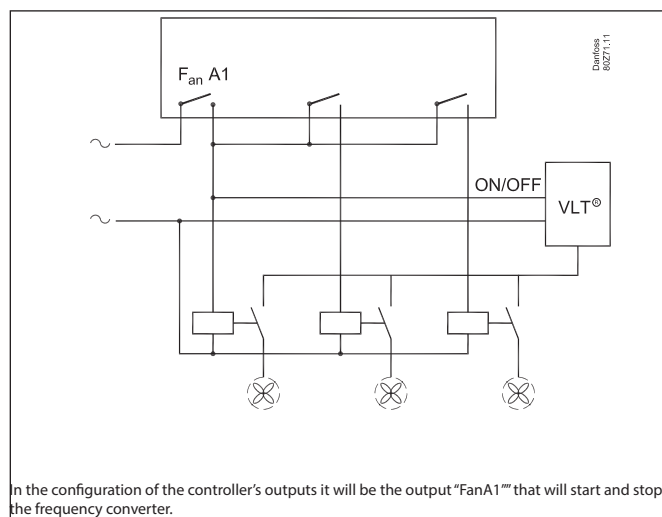

In the configuration of the controller's outputs it will be the output "FanA1" that will start and stop the frequency converter.

Speed regulation of first fan + step regulation of the rest

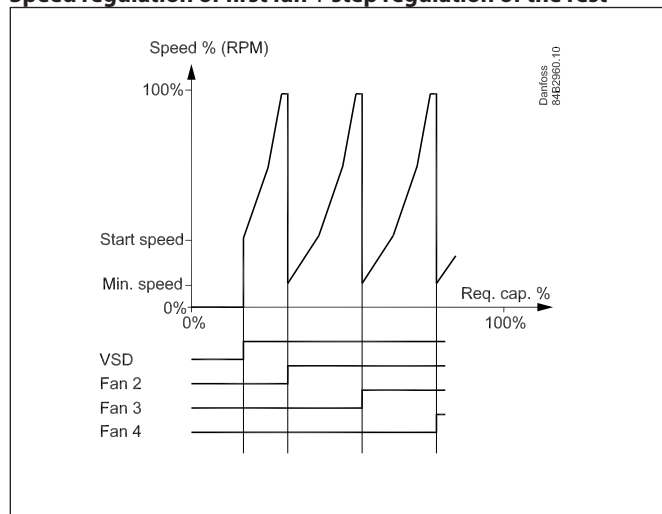

The controller starts the frequency converter and increases the speed of the first fan.

If additional capacity is required, the next fan cuts in at the same time as the first fan switches to minimum speed. From here, the first fan can increase speed again, etc.

Capacity limitation during night operation

The function is used to reduce the noise from the fans to a minimum. It is primarily used in conjunction with a speed control, but it will also be active when steps are cut in and out. The setting is arranged as a percentage of the max. capacity.

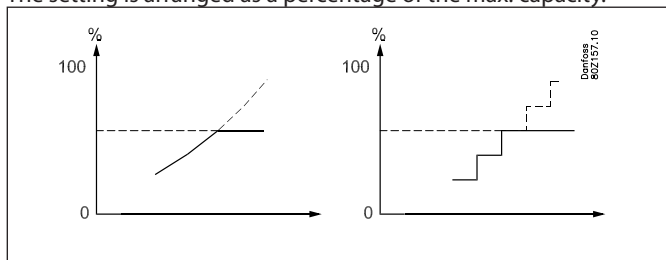

The limitation will be disregarded when safety functions Sd max. and Pc max. take effect.

Condenser couplings

Coupling of condenser steps

There are no time delays in connection with cutin and cutout of condenser steps beyond the time delay inherent in the PI/P-regulation.

Timer

The operating time of a fan motor is registered continuously. You can read out:

- operating time for the previous 24-hour period
- total operating time since the timer was last set to zero-set.

Coupling counter

The number of couplings is registered continuously. Here the number of starts can be read out:

- number during the previous 24-hour period
- total number since the counter was last set to zero-set.

Safety functions for condenser

Signal from fan and frequency converter's safety controls

The controller can receive signals on the status of each individual condenser step's safety circuit.

The signal is obtained directly from the safety circuit and connected to a "DI" input.

If the safety circuit is cut out the controller will give alarm.

Regulation continues with the remaining steps.

The ancillary relay outlet is not cut-out. The reason for this is that the fan are often connected in pairs but with one safety circuit. With fault on the one fan, the other will continue to operate.

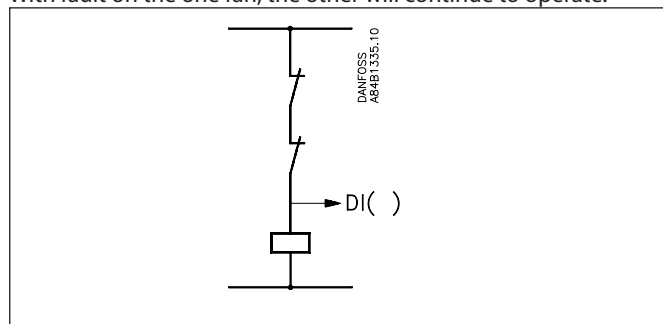

Intelligent fault detection (FDD) on the condenser's air flow

The controller collects measurements from the condenser control and will advise if/when the condenser's capacity is reduced. The most frequent reasons for the information will be:

- gradual accumulation of dirt on the fins
- foreign body in the suction
- fan stop

The function requires a signal from an outdoor temperature sensor (Sc3).

In order to detect accumulation of dirt it is necessary for the monitoring function to be connected to the relevant condenser. This is accomplished by tuning the function when the condenser is clean. The tuning must not be started until the plant has been run in and runs under normal operation conditions.

General monitoring functions

General alarm inputs (10 units)

An input can be used for monitoring an external signal.

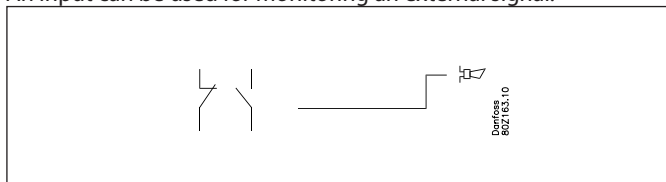

The individual signal can be adapted to the relevant use as it is possible to give the alarm function a name and to indicate your own alarm text.

A time delay can be set for the alarm.

General thermostat functions (5 units)

The function may freely be used for alarm monitoring of the plant temperatures or for ON/OFF thermostat control. An example could be thermostat control of the fan in the compressor compartment.

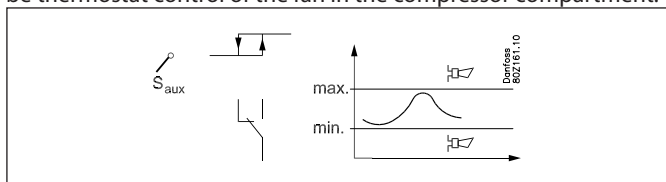

The thermostat can either use one of the sensors used by the regulation (Ss, Sd, Sc3) or an independent sensor (Saux1, Saux2, Saux3, Saux4).

Cutin and cutout limits are set for the thermostat. Coupling of the thermostat's output will be based on the actual sensor temperature. Alarm limits can be set for low and high temperature, respectively, including separate alarm delays.

The individual thermostat function can be adapted to the relevant application as it is possible to give the thermostat a name and to indicate alarm texts.

General voltage input with ancillary relay (5 units)

5 general voltage inputs are accessible for monitoring of various voltage measurements of the installation. Examples are monitoring of a leak detector, moisture measurement measurement and level signal - all with ancillary alarm functions. The voltage inputs can be used to monitor standard voltage signals (0-5V, 1-5V, 2-10V or 0-10V). If required, one can also use 0-20mA or 4-20mA if external resistance is placed at the inlet to adjust the signal to the voltage. A relay outlet can be attached to the monitoring so that one can control external units.

For each inlet, the following can be set/read out:

- Freely definable name
- Selection of signal type (0-5V, 1-5V, 2-10V, or 0-10V)
- Scaling of read-out so it corresponds to measuring unit
- High and low alarm limit including delay times
- Freely definable alarm text
- Attach a relay output with cut in and cut-out limits including delay times

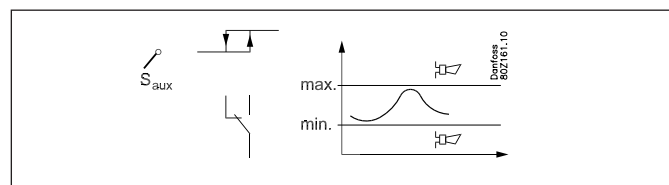

General pressure control functions (5 units)

The function may freely be used for alarm monitoring of plant pressure or for ON/OFF pressure control regulation.

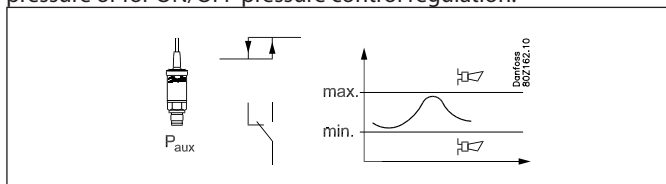

The pressure control can either use one of the sensors used by the control function (Po, Pc) or an independent sensor (Paux1, Paux2, Paux3).

Cutin and cutout limits are set for the pressure control. Coupling of the pressure control's output will be based on the actual pressure. Alarm limits can be set for low and high pressure, respectively, including separate alarm delays.

The individual pressure control function can be adapted to the relevant application as it is possible to give the pressure control a name and indicate alarm texts.

Miscellaneous

Main switch

The main switch is used to stop and start the controlling function.

The switch-over has 2 positions:

- Normal controlling state (Setting = ON)
- Control stopped. (Setting = OFF)

In addition, one can also choose to use a digital input as an external main switch.

If the switch-over or the external main switch is set at OFF, all the control's functions are inactive and an alarm is generated to draw attention to this – all other alarms cease.

Refrigerant

Before regulation can be commenced, the refrigerant must be defined.

You can select one of the following refrigerants:

1 R12	12 R142b	23 R410A	34 R427A
2 R22	13 User defined	24 R170	35 R438A
3 R134a	14 R32	25 R290	36 R513A
4 R502	15 R227	26 R600	37 R407F
5 R717	16 R401A	27 R600a	38 R1234ze
6 R13	17 R507	28 R744	39 R1234yf
7 R13b1	18 R402A	29 R1270	40 R448A
8 R23	19 R404A	30 R417A	41 R449A
9 R500	20 R407C	31 R422A	42 R452A
10 R503	21 R407A	32 R413A	
11 R114	22 R407B	33 R422D	

The refrigerant can only be changed if the "Main switch" is set at "stopped control".

Warning: Incorrect selection of refrigerant can cause damage to the compressor.

Sensor failure

If lack of signal from one of the connected temperature sensors or pressure transmitters is registered an alarm will be given.

- When there is a S4 and P0 error regulation will continue with 50% cut-in capacity during day operation and 25% cut-in capacity during night operation – but minimum one step. (The values can be set). The relay for "Extra cooling" will be activated in the event of an error in the control sensor.
- In the case of an S4 error, control continues by suction pressure P0. This is now with a reference that is 5K under the current reference for S4.
- When there is a Pc error 100% condenser capacity will be cut in, but the compressor regulation will remain normal.
- When there is an error on the Sd sensor the safety monitoring of the discharge gas temperature will be discontinued.
- When there is an error on the Ss sensor the monitoring of the superheat on the suction line will be discontinued.
- When there is an error on the outdoor temperature sensor Sc3 the "FDD" function will cease. Regulation with variable condensing pressure reference cannot either be carried out. Instead you use the PC ref. min. value as reference.
- S7 error: See page 93.

NB: An incorrect sensor must be in order for 10 minutes before the sensor alarm deactivates.

Sensor calibration:

The input signal from all connected sensors can be corrected. A correction will only be necessary if the sensor cable is long and has a small cross-sectional area. All displays and functions will reflect the corrected value.

Clock function

The controller contains a clock function.

The clock function is used only to change between day/night. The year, month, date, hour and minutes must be set.

Note: If the controller is not equipped with a RTC module (AK-OB 101A) the clock must be reset after each mains voltage outage.

If the controller is connected to an installation with an AKA-gateway or an AK system manager, this will automatically reset the clock function.

Alarms and messages

In connection with the controller's functions, there are a number of alarms and messages that become visible in cases of fault or erroneous operation.

Alarm history:

The controller contains an alarm history (log) that contains all active alarms as well as the last 40 historical alarms. In the alarm history you can see when the alarm began and when it stopped. In addition, one can see the priority of each alarm as well as when the alarm has been acknowledged and by which user.

Alarm priority:

Differentiation is made between important and not-so-important information. The importance – or priority – is set for some alarms whilst others can be changed voluntarily (this change can only be done with attachment of AK-ST service tool software to the system and settings must be made in each individual controller).

The setting decides which sorting / action must be carried out when an alarm is sounded.

- "High" is the most important
- "Log only" is the lowest
- "Interrupted" results in no action

Alarm relay

One can also choose whether one requires an alarm output on the controller as a local alarm indication. For this alarm relay it is possible to define on which alarm priority it must react to – one can choose between the following:

- "Non" – no alarm relay is used
- "High" – Alarm relay is activated only with alarms with high priority
- "Low - High" – Alarm relay is activated only with alarms with "low" priority, "medium" or "high" priority.

The relationship between alarm priority and action appears in the schedule below.

Setting	Log	Alarm relay			Send Network	AKM destination
		Non	High	Low-High		
High	X		X	X	X	1
Medium	X			X	X	2
Low	X			X	X	3
Log only	X					
Interrupted						

Alarm acknowledgement

If the controller is connected to a network with an AKA gateway or an AK system manager as alarm receiver, these will automatically acknowledge the alarms that are sent to them.

If the controller on the other hand is not included in a network, the user must acknowledge all alarms.

Alarm LED

The alarm LED on the front of the controller indicates the controller's alarm status.

Blinking: There is an active alarm or an unacknowledged alarm.

Fixed light: There is an active alarm that has been acknowledged.

Switched off: There are no active alarms and no unacknowledged alarms.

IO Status and manual

The function is used in connection with installation, servicing and fault-finding on the equipment.

With the help of the function, the connected outputs are controlled.

Measurements

The status of all inlets and outlets can be read and controlled here.

Forced operation

One can carry out an override of all outlets here to control whether these are correctly attached.

Note: There is no monitoring when the outlets are overridden.

Logging/registration of parameters

As a tool for documentation and fault-finding, the controller provides the possibility of logging of parameter data in the internal memory.

Via AK-ST 500 service tool software one can:

- Select up to 10 parameter values the controller will continuously register
- State how often they must be registered

The controller has a limited memory but as a rule of thumb, the 10 parameters can be saved, which are registered every 10 minutes for 2 days.

Via AK-ST 500 one can subsequently read the historical values in the form of graph presentations.

Output signal for e.g. COP calculation

The controller can transmit an analog signal, e.g. 0-10 V. The signal indicates how much of the compressor capacity is cut in.

Forced operation via network

The controller contains settings that can be operated from the gateway's forced operation function via data communication.

When the forced operation function asks about one change, all the connected controllers on this network will be set simultaneously.

There are the following options:

- Change to night operation
- Forced closure of injection valves (Injection ON)
- Optimising of suction pressure (Po)

Operating AKM / Service tool

The setup of the controller itself can only be carried out via AK-ST 500 service tool software. The operation is described in fitters on site guide.

If the controller is included in a network with an AKA gateway one can subsequently carry out the daily operation of the controller via AKM system software, i.e. one can see and change daily read-outs/settings.

Note: AKM system software does not provide access to all configuration settings of the controller. The settings/read-outs that may be made appear in the AKM menu operation (see also Literature overview).

Authorisation / Passwords

The controller can be operated with System software type AKM and service tool software AK-ST 500.

Both methods of operation provide the possibility for access to several levels according to the user's insight into the various functions.

System software type AKM:

The various users are defined here with initials and key word. Access is then opened to exactly the functions that the user may operate.

The operation is described in the AKM manual.

Service tool software AK-ST 500:

The operation is described in fitters on site guide.

When a user is created, the following must be stated:

- State a user name
- State a password
- Select user level
- Select units – either US (e.g. °F and PSI) or Danfoss SI (°C and Bar)
- Select language

Access is given to four user levels.

- DFLT – Default user – Access without use of password
See daily settings and read-outs.
- Daily – Daily user
Set selected functions and carry out acknowledgement of alarms.
- SERV – Service user
All settings in the menu system except for creation of new users
- SUPV – Supervisor user
All settings including the creation of new users.

Display of brine temperature and condensing pressure

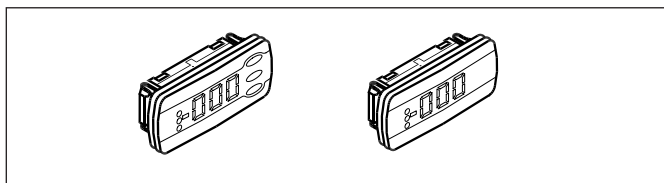

One to four separate displays can be connected to the controller. Connection is accomplished by means of wires with plug connections. The display may be placed in a control box front, for example.

When a display is connected, it will show the value for what is indicated in the configuration:

- fx.
- compressors regulation sensor
 - P0
 - P0 bar (abs)
 - S3
 - S4
 - Ss
 - Sd
 - Condensers regulation sensor
 - Pc
 - Pc bar (abs)
 - S7

When a display with control buttons is chosen, a simple operation via a menu system can be performed in addition to the display of brine temperature and condensing pressure.

No.	Function	Cond.	Suction	Pack
d02	Defrost stop temperature	x	x	x
o30	Refrigerant setting	x	x	x
d04	Max defrost time (safety time at stop on temperature)	x	x	x
d06	Drip delay. Time before cooling starts after defrost	x	x	x
o57	Capacity setting for condenser 0: MAN, 1: OFF, 2: AUTO	x		x
o58	Manual setting of condenser capacity	x		x
o59	Capacity setting for suction group 0: MAN, 1: OFF, 2: AUTO		x	x
o60	Manual setting of suction capacity		x	x
o62	Select of predefined configuration This setting will give a selection of predefined combinations which at the same time establish the connections points.. At the end of the manual an overview of options and connection points is shown. After the configuration of this function the controller will shut down and restart	x	x	x
o93	Lock of configuration It is only possible to select a predefined configuration or change refrigerant when the configuration lock is open. 0 = Configuration open 1 = Configuration locked	x	x	x
P31	Pump status 0=stopped. 1=pump 1 running. 2=pump 2 running. 3=both pumps running	x	x	x
P35	Selection of pump control 0=both pumps are stopped. 1=only pump 1 must run. 2=only pump 2 must run. 3=both pumps must run. 4= equalization of operation time (start before stop). 5=equalization of operation time (stop before start)	x	x	x
r12	Main switch 0: Controller stopped 1: Regulating	x	x	x
r23	Set point suction pressure Setting of required suction pressure reference in °C		x	x
r24	Suction pressure reference Actual reference temperature for compressor capacity		x	x
r28	Set point condenser Setting of required condenser pressure in °C	x		x
r29	Condenser reference Actual reference for temperature for condenser capacity	x		x
r57	Po evaporating pressure in °C		x	x
u09	Temperature at defrost sensor	x	x	x
u11	Defrost time or duration of last defrost	x	x	x
u12	S3 temperature	x	x	x
u16	Actual media temperature measured with S4		x	x
u21	Superheat in suction line		x	x
u44	Sc3 out door temperature in °C	x		x

u48	Actual regulation status on condenser 0: Power up 1: Stopped 2: Manuel 3: Alarm 4: Restart 5: Standby 10: Full loaded 11: Running	x		x
u49	Cut in condenser capacity in %	x		x
u50	Reference for condenser capacity in %	x		x
u51	Actual regulation status on suction group 0: Power up 1: Stopped 2: Manuel 3: Alarm 4: Restart 5: Standby 10: Full loaded 11: Running		x	x
u52	Cut in compressor capacity in %		x	x
u53	Reference for compressor capacity		x	x
u54	Sd discharge gas temperature in °C		x	x
u55	Ss Suction gas temperature in °C		x	x
u98	Actual temperature for S7 media sensor		x	x
u99	Pctrl pressure in °C (cascade pressure)		x	x
U01	Actual Pc condensing pressure in °C	x		x
			x	x
AL1	Alarm suction pressure		x	x
AL2	Alarm condenser	x		x
-- 1	Initiation, Display is connected to output "A", (-- 2 = output "B" etc.)	x	x	x

If you want to see one of the values for what is given under "function" you should use the buttons in the following way:

1. Press on the upper button until a parameter is shown
2. Press on the upper or lower button and find the parameter you want to read
3. Press on the middle button until the value of the parameter is displayed.

After a short time, the display will return automatically to the "Read out display".

Secondary display

The following readings can be displayed by pressing the bottom button on the display:

For display A: Condenser's regulating sensor

For display B: Compressor's regulating sensor.

Light-emitting diodes on the controller

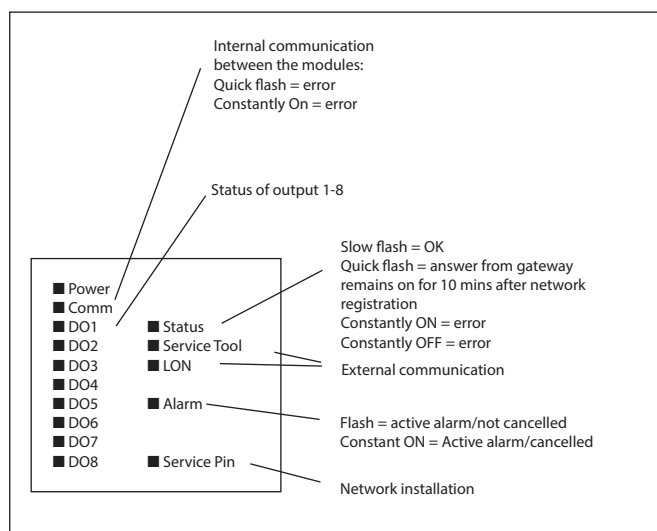

Appendix A – Compressor combinations and coupling patterns

In this section, there is a more detailed description of the compressor combinations and the associated coupling patterns. Sequential operation is omitted from the examples since the compressors are only connected in accordance with their compressor number (First In - Last Out principle) and only speed-regulated compressors are used to fill capacity gaps.

Compressor application 1 – single step

The capacity distributor is capable of managing up to 6 one-step compressors according to the following coupling patterns:

- Sequential
- Cyclical
- Best fit

Cyclical operation - example

Here, all compressors are of the same size and the compressors are cut in and cut-out in accordance with the First-In-First-Out (FIFO) principle, in order to equalise operating hours between the compressors.

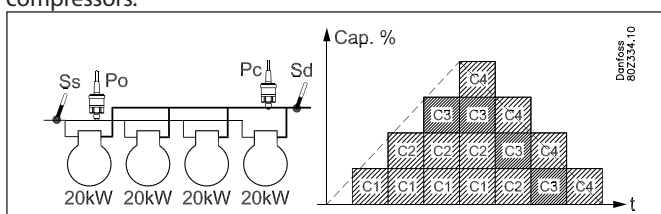

- There is operating time equalizing between all compressors
- The compressor with the fewest running hours starts first
- The compressor with the most running hours stops first.

Best fit - example

Here are at least two compressors of different sizes. The capacity distributor will cut in and cut-out the compressors to produce the best possible capacity fit (the least possible capacity jump).

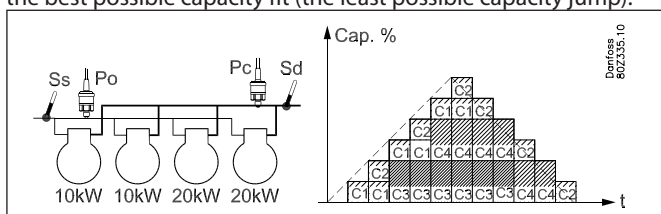

- There is operating time equalizing between the compressors 1 and 2 (same size in example).
- There is operating time equalizing between the compressors 3 and 4 (same size in example).

Compressor application 2 – 1 x unload + single step

The controller is able to control a combination of one capacity controlled and multiple single step compressors. The advantage of this combination is that the unloader valves will be used to fill in capacity gaps and thereby achieve many capacity steps via few compressors.

Preconditions for using this compressor application are:

- All compressors are the same size
- The capacity-regulated compressor can have up to three unload valves.
- The main step and the unload valves can be different sizes, i.e. 50%, 25% and 25%.

This compressor combination can be handled in the following coupling patterns:

- Sequential
- Cyclical

General regarding Handling:

Cutin

The capacity-regulated compressors with unloader valves start before one-step compressors. The capacity controlled compressor will always be fully loaded before cutting-in of subsequent one-step compressors.

Cutout

The capacity regulated compressor will always be the last to stop. The capacity controlled compressor will always be fully loaded before cut-in of subsequent one-step compressors.

Unloader valves

At cyclical operation unloader valves are used to close capacity holes from the subsequent one-step compressors.

Anti-cycle timer restrictions

In case a capacity controlled compressor is prevented in starting due to anti-cycle timer restrictions, then the start of any subsequent one-step compressors is not allowed. The capacity controlled compressor is started when the timer restriction has expired.

Cyclical operation - example

The one-step compressors will be cut in and cut-out in accordance with The First-In-First-Out (FIFO) principle in order to equalise operating hours between the compressors.

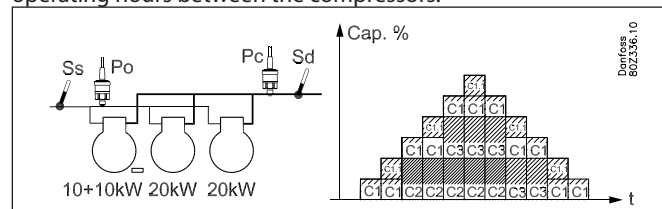

- The capacity controlled compressor is the first to start and the last to stop.
- Unloader valves are used to close capacity holes
- There is operating time equalizing between the compressors 2 and 3 (same size in example).

Compressor application 3 – 2 x unload + single step

The controller is able to control a combination of capacity controlled and multiple single step compressors. The advantage of this combination is that the unloader valves will be used to fill in capacity gaps and thereby achieve many capacity steps via few compressors.

Preconditions for using this compressor application are:

- All compressors are the same size
- The capacity-regulated compressors have the same number of unload valves (max 3)
- The main step on the capacity-regulated compressors have the same size
- The main step and the unload valves can be different sizes, i.e. 50%, 25% and 25%.

This compressor combination can be handled in accordance with the following coupling patterns:

- Sequential
- Cyclical

In general, regarding handling of the capacity-regulated compressors:

Cutin

The capacity-regulated compressors with unloader valves start before one-step compressors. The capacity controlled compressor will always be fully loaded before cutting-in of subsequent one-step compressors.

Cutout

The capacity regulated compressor will always be the last to stop. Handling of the unload valves depends on the setting of "unloader ctrl mode".

Unloader valves

At cyclical operation unloader valves are used to close capacity holes from the subsequent one-step compressors.

Anti-cycle timer restrictions

In case a capacity controlled compressor is prevented in starting due to anti-cycle timer restrictions, then the start of any subsequent one-step compressors is not allowed. The capacity controlled compressor is started when the timer restriction has expired.

Cyclical operation - example

The one-step compressors will be cut in and cut out in accordance with the First-In-First-Out (FIFO) principle in order to equalise operating hours between the compressors.

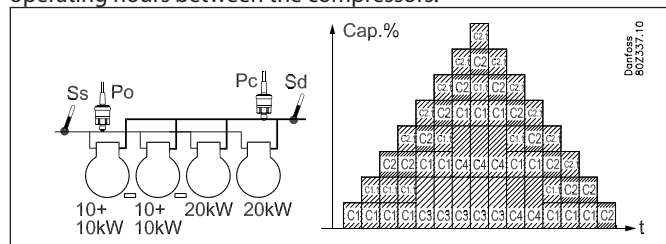

- The capacity controlled compressor is the first to start and the last to stop.
- Operating hours are equalised between the capacity-regulated compressors
- The unloader valve on the capacity-regulated compressor is used to fill capacity gaps
- Operating hours are equalised between the one-step compressors 3 and 4.

Compressor application 4 – Only capacity controlled compressors

The controller is capable of controlling capacity-regulated piston compressors of the same size with up to 3 unload valves.

Preconditions for using this compressor application are:

- All compressors are the same size
- The capacity-regulated compressors have the same number of unload valves (max 3)
- The main step on the capacity-regulated compressors are the same size
- The main step and the unload valves can be different sizes, i.e. 50%, 25% and 25%.

This compressor combination can be handled in the following coupling patterns:

- Sequential
- Cyclical

Cyclical operation - example

The compressors are cut in and cut out in accordance with the First-In-First-Out (FIFO) principle to equalise operating hours between compressors.

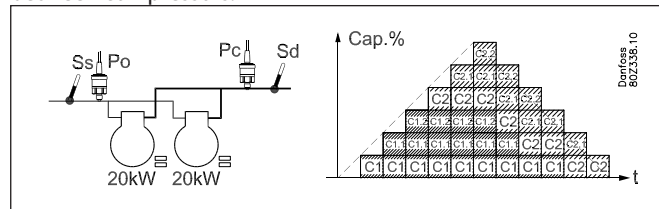

- For cyclical operation, the compressor with the fewest running hours starts (C1)
- Only when compressor C1 is completely loaded, should compressor C2 be cut in
- For cut-out, the compressor with the most operating hours should be unloaded (C2)
- When this compressor is completely unloaded, the second compressor is unloaded by one step before the main step on the completely unloaded compressor is cut out.

Compressor application 5 – 1 x Speed + single step

The controller is capable of controlling one speed-regulated compressor combined with one-step compressors of the same or different sizes.

Preconditions for using this compressor application are:

- A speed-regulated compressor that can be of a different size than the following one-step compressors
- Up to 11 one-step compressors of the same or different capacity (depending on coupling pattern)

This compressor combination can be handled in accordance with the following coupling patterns:

- Sequential
- Cyclical
- Best fit

Handling the speed-regulated compressor.

For more information on the general handling of the speed-regulated compressor, refer to section "Power pack types".

Cyclical operation - example

Here, the one-step compressors are of the same size.

The speed-regulated compressor is always the first to start and the last to stop.

One-step compressors should be cut in and cut out in accordance with the First-In-First-out principle in order to equalise operating hours.

The speed-regulated compressor is used to fill the capacity gaps between the one-step compressors.

Example:

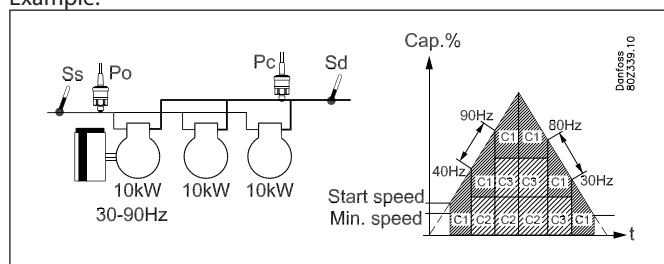

Increasing capacity:

- The speed-regulated compressor starts when the desired capacity equals the start speed
- The following one-step compressor with the smallest number of operating hours cut in when the speed-regulated compressor is running at full speed (90 Hz)
- When a one-step compressor cuts in, the speed-regulated compressor reduces speed (40 Hz) equivalent to the capacity of the one-step compressor.

Decreasing capacity:

- The following one-step compressors with the most operating hours should be cut out when the speed-regulated compressor reaches minimum speed (30 Hz)
- When a one-step compressor is cut out, the speed-regulated compressor's speed increases (80 Hz), equivalent to the capacity of the one-step compressor
- The speed-regulated compressor is the last compressor to be cut out when the preconditions for this are fulfilled.

Best fit - example:

Here, at least two of the one-step compressors are of different sizes.

The speed-regulated compressor is always the first to start and last to stop.

The capacity distributor cuts in and cuts out the one-step compressors in order to achieve the best possible capacity fit (least

possible capacity jump)

The speed-regulated compressor is used to fill out the capacity gaps between the one-step compressors.

Example:

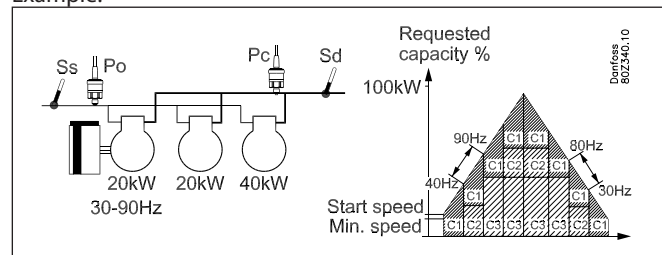

Increasing capacity:

- The speed-regulated compressor starts when the desired capacity matches the start speed
- The smallest one-step compressor is cut in when the speed-regulated compressor runs at full-speed (90 Hz).
- When the speed-regulated compressor again reaches max. speed (90 Hz), the smallest one-step compressor is cut out (C2) and the big one-step compressor (C3) is cut in.
- When the speed-regulated compressor again reaches max speed (90 Hz), the smallest one-step compressor (C2) is cut in again.
- When the one-step compressor is cut in, the speed is reduced on the speed-regulated compressor (40 Hz) equivalent to the capacity of the cut in capacity

Decreasing capacity:

- The small one-step compressor is cut out when the speed-regulated compressor has reached minimum speed (30 Hz)
- When the speed-regulated compressor again reaches minimum speed (30 Hz), the smallest one-step compressor (C2) is cut out and the big one-step compressor (C3) is cut in.
- When the speed-regulated compressor again reaches min. speed (30 Hz), the large one-step compressor (C3) is cut out and the small one-step compressor (C2) is cut in again.
- When the speed-regulated compressor again reaches min. speed (30 Hz), the small one-step compressor (C2) is cut in.
- The speed-regulated compressor is the last compressor to be cut out when the requirements for this are fulfilled.
- When the one-step compressor's capacity is cut out, the speed-regulated compressor increases speed (80 Hz) equivalent to the cut out capacity.

Compressor application 6 – 1 x Speed + unloader

The controller can operate one speed-regulated compressor combined with several capacity-regulated compressors of the same size and with the same number of unloaders.

The advantage of this combination is that the variable part of the speed-regulated compressor only needs to be large enough to cover the following unload valves in order to achieve a capacity curve without gaps.

Preconditions for using this compressor application are:

- A single speed-regulated compressor that can be of a different size than the following compressors
- The capacity-regulated compressors are the same size and have the same number of unload valves (max. 3)
- The main step on the capacity-regulated compressors are the same size
- The main step and the unload valves can be different sizes, i.e. 50%, 25% and 25%.

This compressor combination can be handled in the following coupling patterns:

- Sequential
- Cyclical

Handling the speed-regulating compressor.

For further information on the general handling of the speed-regulated compressor, refer to section "Power pack types".

Cyclical operation - example

The speed-regulated compressor is always the first to start and last to stop.

The capacity-regulated compressors are cut in and cut out in accordance with the First-in-First-Out principle in order to equalise operating hours

The speed-regulated compressor is used to fill the capacity gaps between the unload valves/main steps.

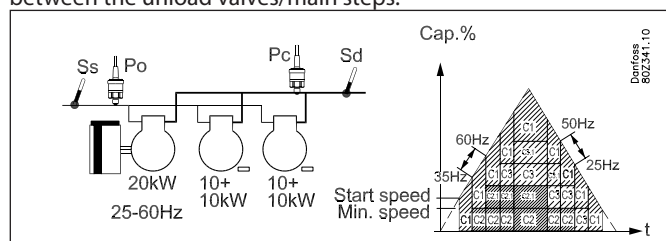

Increasing capacity:

- The speed-regulated compressor starts when the desired capacity matches the start speed
- The main step on the capacity-regulated compressor with fewest operating hours (C1) is cut in when the speed-regulated compressor runs at full speed (60 Hz)
- The unload valves are cut in gradually as the speed-regulated compressor again reaches max. speed (60 Hz)
- The main step on the last capacity-regulated compressor (C2) is cut in when the speed-regulated compressor again reaches max. speed (60 Hz)
- The unload valves are cut in gradually as the speed-regulated compressor again reaches max. speed (60 Hz)
- When the main step or unload valves are cut in, the speed is reduced on the speed-regulated compressor (35 Hz) is equivalent to the capacity of the cut in capacity.

Decreasing capacity:

- The capacity-regulated compressor with the most operating hours (C2) cuts out an unload valve when the speed-regulated compressor has reached min. speed (25 Hz)
- When the speed-regulated compressor again reaches min. speed (25 Hz), the unload valve is cut out on the next capacity-regulated compressor (C3)
- When the speed-regulated compressor again reaches min. speed (25 Hz), the main step is cut out on the capacity-regulated compressor with the most operating hours (C2)
- When the speed-regulated compressor again reaches min. speed (25 Hz), the main step is cut out on the last capacity-regulated compressor (C3)
- The speed-regulated compressor is the last compressor that is cut out when the conditions for this are fulfilled
- When the main step or unload valves are cut out, the speed of the speed-regulated compressor increases (50 Hz) to equivalent to the cut out capacity

Compressor application 7 – 2 x Speed + single

The controller can control two speed-regulated compressors combined with several one-step compressors that may be the same or different in size (depending on the selected coupling pattern). The advantage of using two speed-regulated compressors is that it is then possible to reach a very low capacity, which is an advantage with low loads while at the same time a very high variable regulating range is possible.

Preconditions for using this compressor application are:

- Two speed-regulated compressors which can be of a different size than the following one-step compressors
- The speed-regulated compressors can be the same or different sizes (depending on the choice of coupling pattern)
- The same frequency band for both speed-regulated compressors
- One-step compressors of the same or different sizes (depending on the choice of coupling pattern)

This compressor combination can be handled in accordance with the following coupling patterns:

- Sequential
- Cyclical
- Best fit

Handling the speed-regulated compressor.

For more information on the general handling of the speed-regulated compressors, refer to section "Power pack types".

Cyclical operation - example

Here the speed-regulated compressors are the same size. The one-step compressors should also be the same size.

The speed-regulated compressor is always the first to start and the last to stop.

The capacity-regulated compressors cut in and cut out in accordance with the operating time (First-In-First-Out principle).

The speed-regulated compressor is used to fill the capacity gaps between the following one-step compressors.

Example:

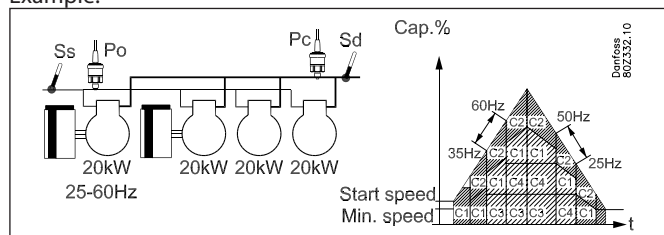

Increasing capacity:

- The speed-regulated compressor with the least operating hours (C1) starts when the desired capacity equals the start speed
- The following speed-regulated compressor C2 is cut in when the first speed-regulated compressor (C1) has reached max. speed (60 Hz) so that the compressors run in parallel.
- When the two speed-regulated compressors reach full speed (60 Hz) the one-step compressor with the fewest operating hours is cut in (C3)
- When the two speed-regulated compressors again reach full speed (60 Hz) the last one-step compressor cuts in (C4)
- When one-step compressors are cut in, the speed is reduced on the speed-regulated compressor (35 Hz) equivalent to the cut in capacity.

Decreasing capacity:

- The one-step compressor with the most operating time (C3)

is cut out when the speed-regulated compressor reaches min speed (25 Hz)

- When the two speed-regulated compressors again reach min speed (25 Hz), the last one-step compressor is cut out (C4)
- When the two speed-regulated compressors again reach min speed (25 Hz), the speed-regulated compressor with the most operating hours is cut out (C1)
- The last speed-regulated compressor (C2) is cut out when the requirements for this are fulfilled
- When one-step compressors are cut out, the speed-regulated compressors' speed increases (50 Hz), equivalent to the cut out capacity.

Best fit - examples

Here, either the two speed-regulated compressors are of different sizes, or the following one-step compressors are of different sizes. The speed-regulated compressors are always the first to start and the last to stop.

The capacity distributor cuts in and cuts out both speed-regulated and one-step compressors in order to reach the best possible capacity adjustment (least possible capacity jump).

Example 1

In this example, the speed-regulated compressors are of the same size and the following one-step compressors are of different sizes.

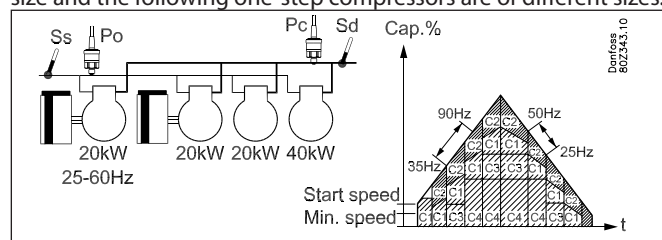

Increasing capacity:

- The speed-regulated compressor with the least operating hours (C1) starts when the desired capacity equals the start speed
- When the first speed-regulated compressor (C1) has reached max. speed (60 Hz), the second speed-regulated compressor (C2) cuts in so that the compressors run in parallel
- When the two speed-regulated compressors reach full speed (60 Hz), the small one-step compressor (C3) is cut in
- When the two speed-regulated compressors again reach full speed (60 Hz), the large one-step compressor (C4) is cut in and the small one-step compressor (C3) is cut out
- When the two speed-regulated compressors again reach full speed (60 Hz), the small one-step compressor (C4) is cut in again.
- When the one-step compressor is cut in, the speed is reduced on the speed-regulated compressor (35 Hz) corresponding to the cut in capacity

Decreasing capacity:

- The small one-step compressor (C3) is cut out when the speed-regulated compressor reaches the min. speed (25 Hz)
- When the two speed-regulated compressors again reach min. speed (25 Hz), the big one-step compressor (C4) is cut in and the small one-step compressor (C3) is cut out
- When the two speed-regulated compressors again reach min. speed (25 Hz), the large one-step compressor (C4) is cut out and the small one-step compressor (C3) is cut in
- When the two speed-regulated compressors again reach min speed (25 Hz), the speed-regulated compressor with the most operating hours (C1) is cut out (C1)
- The last speed-regulated compressor (C2) is cut out when the requirements for this are fulfilled

- When one-step compressors cut out, the speed-regulated compressors increase speed (50 Hz), corresponding to the cut out capacity

Example 2:

In this example, the speed-regulated compressors are of different sizes and the following one-step compressors are also of different sizes.

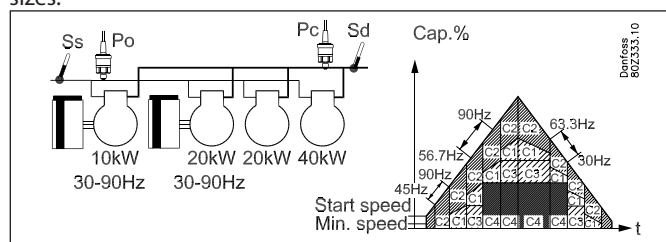

Increasing capacity:

- The smallest speed-regulated compressor (C1) starts when the desired capacity equals the start speed
- When the smallest speed-regulated compressor (C1) has reached max. speed (90 Hz), the large speed-regulated compressor (C2) cuts in and the small speed-regulated compressor cuts out.
- When the large speed-regulated compressor reaches max. speed (90 Hz), the small speed-regulated compressor (C1) cuts in again so that the compressors run in parallel
- When the two speed-regulated compressors reach full speed (90 Hz), the small one-step compressor (C3) is cut in
- When the two speed-regulated compressors again reach full speed (60 Hz), the big one-step compressor (C4) cuts in and then the small one-step compressor (C3) cuts out
- When the two speed-regulated compressors again reach full speed (60 Hz), the small one-step compressor (C4) is cut in again.
- When the one-step compressors are cut in, the speed decreases on the speed-regulated compressor (56.7 Hz) corresponding to the cut in capacity

Decreasing capacity:

- The small one-step compressor (C3) is cut out when the speed-regulated compressor reaches min. speed (30 Hz)
- When the two speed-regulated compressors again reach min. speed (30 Hz) the big one-step compressor (C4) cuts in and the small one-step compressor (C3) cuts out.
- When the two speed-regulated compressors again reach min. speed (30 Hz), the big one-step compressor (C4) cuts out and the small one-step compressor (C3) cuts in.
- When the two speed-regulated compressors again reach min. speed (30 Hz), the small speed-regulated compressor (C1) cuts out.
- When the big speed-regulated compressor reaches min. speed (30 Hz), it is cut out and the small speed-regulated compressor is cut in (C1)
- The small speed-regulated compressor (C1) is cut out when the conditions for this are met.
- When the one-step compressors are cut out, the speed-regulated compressors' speed increases (63.3 Hz) equivalent to the cut out capacity.

Appendix B - Alarm texts

Settings	Priority (factory)		English alarm texts	Description
Suction group				
Control mode	Low		Manual comp. cap. Control	Manual control of compressors
Low suction pressure P0	Low		Low pressure P0	Minimum safety limit for suction pressure P0 has been exceeded
High suction pressure P0	High		High pressure P0	High alarm limit for P0 has been exceeded
High S4 temperature	High		High S4 temp.	High S4 temperature
Low S4 temperature	Medium		Low S4 temp.	Low S4 temperature
High/Low superheat Ss	Medium		High superheat suction A	Superheat in suction line too high
			Low superheat section A	Superheat in suction line too low
Load shedding	Medium		Load Shed active	Load shedding has been activated
P0/S4 sensor error	High		P0A sensor error	Pressure transmitter signal from P ₀ is defective
			S4A sensor error	Temperature signal from S4 media temp. sensor defective
Misc. sensor error	High		S3 sensor error	Temperature signal from S3 media temp. sensor defective
			SsA sensor error	Temperature signal from Ss suction gas temp. is defective
			SdA sensor error	Temperature signal from Sd discharge gas temp. is defective
			Sc3 sensor error	Temperature signal from Sc3 air on condenser defective
			Heat recovery sensor error	Temperature signal from Shrec heat recovery thermostat defective
			Saux1 sensor error	Signal from extra Temp. sensor Saux1 is defective
			Saux2 sensor error	Signal from extra Temp. sensor Saux2 is defective
			Saux3 sensor error	Signal from extra Temp. sensor Saux3 is defective
	Saux4 sensor error	Signal from extra Temp. sensor Saux4 is defective		
Pump alarm	Medium		Cold pump 1 alarm	Cold pump 1 is defective
			Cold pump 2 alarm	Cold pump 2 is defective
Cold pump 1&2 alarm	High		Cold pump 1&2 alarm	Both cold pump 1 and 2 are defective
Frost protection	High		Anti freeze safety cutout	All compressors have been cut out on common safety input
All compressors				
Comp. 1 safety Comp. 2 safety Comp. 3 safety Comp. 6 safety	Medium		Comp. X oil pressure cut out	Compressor no. x has been cut out on oil pressure safety
			Comp. x over current cut out	Compressor no. x has been cut out on over current safety
			Comp. 1 motor prot. cut out	Compressor no. x has been cut out on motor protection safety
			Comp. 1 disch. Temp cut out	Compressor no. x has been cut out on discharge temperature safety
			Comp. 1 disch. Press. Cut out	Compressor no. x has been cut out on discharge pressure safety
	Comp. 1 General safety cut out	Compressor no. x has been cut out on general safety		
VSD safety	Medium		Comp. 1 VSD safety error	Variable speed drive for comp. x has been cut out on safety
Condenser				
Control mode	low		Manual cond. cap. Control	Manual control of condenser
High Pc/Sd temp.	High		High disch. temp. SdA	Safety limit for discharge temperature has been exceeded
			High pressure Pc	High safety limit for condensing pressure Pc has been exceeded
Pc/S7 Sensor error	High		PcA sensor error	Pressure transmitter signal from Pc is defective
			S7A sensor error	Temperature signal for S7 media temperature sensor is defective
Detect blocked air flow	Medium		Air flow reduced cond. A	The intelligent air flow monitoring of the condenser reports that a cleaning is due
Fan/VSD safety	Medium		Fan Alarm 1	Fan no. X is reported defective via safety input
			Fan VSD alarm	Variable speed drive for condenser fans has been cut out on safety

Various alarms

Standby mode	Medium		Control stopped, MainSwitch=OFF	The control has been stopped via the setting "Main switch" = Off or the external Main switch is off
Max defrost periode exceeded	Medium		Max defrost periode exceeded	The defrost has stopped on max time and not on temperature
Thermostat x – Low temp. alarm	Low		Thermostat x - Low alarm	The temperature for thermostat no. x has been below the low alarm limit for longer time than set delay
Thermostat x – High temp. alarm	Low		Thermostat x - High alarm	The temperature for thermostat no. x has been above the high alarm limit for longer time than set delay
Pressostat x – Low pressure alarm	Low		Pressostat x - Low alarm	The pressure for pressostat no. x has been below the low alarm limit for longer time than set delay
Pressostat x – alarm limit high pressure	Low		Pressostat x - High alarm	The pressure for pressostat no. x has been above the high alarm limit for longer time than set delay
Voltage input x – Low alarm	Low		Analog input x - Low alarm	The voltage signal has been below the low alarm limit for longer time than set delay
Voltage input x – High alarm	Low		Analog input x - High alarm	The voltage signal has been above the high alarm limit for longer time than set delay
Dlx alarm input	Low		Custom alarm x -define text	Alarm on general alarm input DI x
	Low		Extra cooling req. relay is ON	The controller cannot keep the brine temperature down and has activated the relay that activates extra cooling.

System alarms

The alarm priority can not be altered on system alarms				
	Low		Refrigerant A not selected	Refrigerant has not been selected
	Low		Refrigerant changed	Refrigerant type has been changed
	Medium		Time has not been set	Time has not been set
	Medium		System Critical exception	A unrecoverable critical system failure has occurred – exchange the controller
	Medium		System alarm exception	A minor system failure has occurred – power off controller
	Medium		Alarm destination disabled	When this alarm is activated the alarm transmission to the alarm receiver has been deactivated. Check and wait. When the alarm is cleared the alarm transmission to the alarm receiver has been activated again
	Medium		Alarm route failure	Alarms can not be transmitted to alarm receiver – check communication
	High		Alarm router full	The internal alarm buffer has an overrun – this might occur if the controller can not send the alarms to the alarm receiver. Check communication between controller and system unit.
	Medium		Device is restarting	The controller is restarting after flash updating of the software
	Medium		I/O board failure	There is a communication fault between the controller module and the extension modules – the fault must be corrected as soon as possible
Manual control				
	Low		MAN DI.....	The in put in question has been put in manual control mode via the AK-ST 500 service tool software
	Low		MAN DO.....	The output in question has been put in manual control mode via the AK-ST 500 service tool software

Appendix C - Recommended connection

Function

The controller has a setting where you can choose between various types of installation. If you use these settings, the controller will suggest a series of connection points for the different functions. These points are shown below.

Even if your installation is not 100% as described below, you can still use the function. After use, you need only adjust the divergent settings. The given connection points in the controller can be changed if you wish.

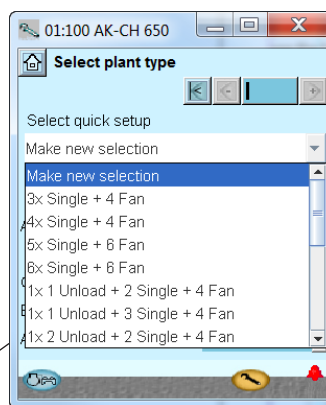

Appl.	Compressor	Fan	Description	Module	Point number					
					1	2	3	4	5	6
1			3 x single 4 fan	Module 1 - Controller	S3	S4	Loadshed 1	Flow switch	Heat recovery	Main Sw.
				Module 2 - AK-XM 102B	Comp. 1 safety	Comp. 2 safety	Comp. 3 safety			
				Module 3 - AK-XM 204_	Fan 1	Fan 2	Fan 3	Fan 4		
2			4 x single 4 fan	Module 1 - Controller	S3	S4	Loadshed 1	Flow switch	Heat recovery	Main Sw.
				Module 2 - AK-XM 102B	Comp. 1 safety	Comp. 2 safety	Comp. 3 safety	Comp. 4 safety		
				Module 3 - AK-XM 204_	Fan 1	Fan 2	Fan 3	Fan 4		
3			5 x single 6 fan	Module 1 - Controller	S3	S4	Loadshed 1	Flow switch	Heat recovery	Main Sw.
				Module 2 - AK-XM 102B	Comp. 1 safety	Comp. 2 safety	Comp. 3 safety	Comp. 4 safety	Comp. 5 safety	
				Module 3 - AK-XM 204_	Fan 1	Fan 2	Fan 3	Fan 4	Fan 5	Fan 6
4			6 x single 6 fan	Module 1 - Controller	S3	S4	Loadshed 1	Flow switch	Heat recovery	Main Sw.
				Module 2 - AK-XM 102B	Comp. 1 safety	Comp. 2 safety	Comp. 3 safety	Comp. 4 safety	Comp. 5 safety	Comp. 6 safety
				Module 3 - AK-XM 204_	Fan 1	Fan 2	Fan 3	Fan 4	Fan 5	Fan 6
5			1 x 1 unload 2 x single 4 fan	Module 1 - Controller	S3	S4	Loadshed 1	Flow switch	Heat recovery	Main Sw.
				Module 2 - AK-XM 102B	Comp. 1 safety	Comp. 2 safety	Comp. 3 safety			
				Module 3 - AK-XM 204_	Fan 1	Fan 2	Fan 3	Fan 4		
6			1 x 1 unload 3 x single 4 fan	Module 1 - Controller	S3	S4	Loadshed 1	Flow switch	Heat recovery	Main Sw.
				Module 2 - AK-XM 102B	Comp. 1 safety	Comp. 2 safety	Comp. 3 safety	Comp. 4 safety		
				Module 3 - AK-XM 204_	Fan 1	Fan 2	Fan 3	Fan 4		
7			1 x 2 unload 2 x single 4 fan	Module 1 - Controller	S3	S4	Loadshed 1	Flow switch	Heat recovery	Main Sw.
				Module 2 - AK-XM 102B	Comp. 1 safety	Comp. 2 safety	Comp. 3 safety			
				Module 3 - AK-XM 204_	Fan 1	Fan 2	Fan 3	Fan 4		
8			1 x 2 unload 3 x single 4 fan	Module 1 - Controller	S3	S4	Loadshed 1	Flow switch	Heat recovery	Main Sw.
				Module 2 - AK-XM 102B	Comp. 1 safety	Comp. 2 safety	Comp. 3 safety	Comp. 4 safety		
				Module 3 - AK-XM 204_	Fan 1	Fan 2	Fan 3	Fan 4	Liquid injection	
9			3 x 1 unload 6 fan	Module 1 - Controller	S3	S4	Loadshed 1	Flow switch	Heat recovery	Main Sw.
				Module 2 - AK-XM 102B	Comp. 1 safety	Comp. 2 safety	Comp. 3 safety			
				Module 3 - AK-XM 204_	Fan 1	Fan 2	Fan 3	Fan 4	Fan 5	Fan 6

Appl.	Point number														
	7	8	9	10	11	12	13	14	15	16	17	18	19	24	25
1	Sc3	Sd	Ss	P0	Pc	Comp. 1	Comp. 2	Comp. 3			Liquid injection	Pump 1	Pump 2		
2	Sc3	Sd	Ss	P0	Pc	Comp. 1	Comp. 2	Comp. 3	Comp. 4		Liquid injection	Pump 1	Pump 2		
3	Sc3	Sd	Ss	P0	Pc	Comp. 1	Comp. 2	Comp. 3	Comp. 4	Comp. 5	Liquid injection	Pump 1	Pump 2		
4	Sc3	Sd	Ss	P0	Pc	Comp. 1	Comp. 2	Comp. 3	Comp. 4	Comp. 5	Comp. 6	Pump 1	Pump 2		
		Liquid injection													
5	Sc3	Sd	Ss	P0	Pc	Comp. 1	Comp. 1 Unload. 1	Comp. 2	Comp. 3		Liquid injection	Pump 1	Pump 2		
6	Sc3	Sd	Ss	P0	Pc	Comp. 1	Comp. 1 Unload. 1	Comp. 2	Comp. 3	Comp. 4	Liquid injection	Pump 1	Pump 2		
7	Sc3	Sd	Ss	P0	Pc	Comp. 1	Comp. 1 Unload. 1	Comp. 1 Unload. 2	Comp. 2	Comp. 3	Liquid injection	Pump 1	Pump 2		
8	Sc3	Sd	Ss	P0	Pc	Comp. 1	Comp. 1 Unload. 1	Comp. 1 Unload. 2	Comp. 2	Comp. 3	Comp. 4	Pump 1	Pump 2		
9	Sc3	Sd	Ss	P0	Pc	Comp. 1	Comp. 1 Unload. 1	Comp. 2	Comp. 2 Unload. 1	Comp. 3	Comp. 3 Unload. 1	Pump 1	Pump 2		
		Liquid injection													

Appl.	Comp.	Fan	Description	Module	Point number					
					1	2	3	4	5	6
10			1 x speed 1 single 4 fan	Module 1 - Controller	S3	S4	Loadshed 1	Flow switch	Heat recovery	Main Sw.
				Module 2 - AK-XM 102B	Comp. 1 safety	Comp. 2 safety	VSD. 1 safety			
				Module 3 - AK-XM 204_	Fan 1	Fan 2	Fan 3	Fan 4		
11			1 x speed 2 single 4 fan	Module 1 - Controller	S3	S4	Loadshed 1	Flow switch	Heat recovery	Main Sw.
				Module 2 - AK-XM 102B	Comp. 1 safety	Comp. 2 safety	Comp. 3 safety	VSD. 1 safety		
				Module 3 - AK-XM 204_	Fan 1	Fan 2	Fan 3	Fan 4		
12			1 x speed 3 single 4 fan	Module 1 - Controller	S3	S4	Loadshed 1	Flow switch	Heat recovery	Main Sw.
				Module 2 - AK-XM 102B	Comp. 1 safety	Comp. 2 safety	Comp. 3 safety	Comp. 4 safety	VSD. 1 safety	
				Module 3 - AK-XM 204_	Fan 1	Fan 2	Fan 3	Fan 4		
13			1 x speed 4 single 6 fan	Module 1 - Controller	S3	S4	Loadshed 1	Flow switch	Heat recovery	Main Sw.
				Module 2 - AK-XM 102B	Comp. 1 safety	Comp. 2 safety	Comp. 3 safety	Comp. 4 safety	Comp. 5 safety	VSD. 1 safety
				Module 3 - AK-XM 204_	Fan 1	Fan 2	Fan 3	Fan 4	Fan 5	Fan 6
14			1 x speed 2 x 1 unload 4 fan	Module 1 - Controller	S3	S4	Loadshed 1	Flow switch	Heat recovery	Main Sw.
				Module 2 - AK-XM 102B	Comp. 1 safety	Comp. 2 safety	Comp. 3 safety	VSD. 1 safety		
				Module 3 - AK-XM 204_	Fan 1	Fan 2	Fan 3	Fan 4		
15			2 x speed 4 fan	Module 1 - Controller	S3	S4	Loadshed 1	Flow switch	Heat recovery	Main Sw.
				Module 2 - AK-XM 102B	Comp. 1 safety	Comp. 2 safety	VSD. 1 safety	VSD. 2 safety		
				Module 3 - AK-XM 204_	Fan 1	Fan 2	Fan 3	Fan 4		
16			2 x speed 2 single 4 fan	Module 1 - Controller	S3	S4	Loadshed 1	Flow switch	Heat recovery	Main Sw.
				Module 2 - AK-XM 102B	Comp. 1 safety	Comp. 2 safety	Comp. 3 safety	Comp. 4 safety	VSD. 1 safety	VSD. 2 safety
				Module 3 - AK-XM 204_	Fan 1	Fan 2	Fan 3	Fan 4		

Appl.	Point number														
	7	8	9	10	11	12	13	14	15	16	17	18	19	24	25
10	Sc3	Sd	Ss	P0	Pc	Comp. 1	Comp. 2				Liquid injection	Pump 1	Pump 2	Comp. speed	
11	Sc3	Sd	Ss	P0	Pc	Comp. 1	Comp. 2	Comp. 3			Liquid injection	Pump 1	Pump 2	Comp. speed	
12	Sc3	Sd	Ss	P0	Pc	Comp. 1	Comp. 2	Comp. 3	Comp. 4		Liquid injection	Pump 1	Pump 2	Comp. speed	
13	Sc3	Sd	Ss	P0	Pc	Comp. 1	Comp. 2	Comp. 3	Comp. 4	Comp. 5	Liquid injection	Pump 1	Pump 2	Comp. speed	
14	Sc3	Sd	Ss	P0	Pc	Comp. 1	Comp. 2	Comp. 2 Unload. 1	Comp. 3	Comp. 3 Unload. 1	Liquid injection	Pump 1	Pump 2	Comp. speed	
15	Sc3	Sd	Ss	P0	Pc	Comp. 1	Comp. 2				Liquid injection	Pump 1	Pump 2	Comp. speed	
16	Sc3	Sd	Ss	P0	Pc	Comp. 1	Comp. 2	Comp. 3	Comp. 4		Liquid injection	Pump 1	Pump 2	Comp. speed	

Installation considerations

Accidental damage, poor installation, or site conditions, can give rise to malfunctions of the control system, and ultimately lead to a plant breakdown.

Every possible safeguard is incorporated into our products to prevent this. However, a wrong installation, for example, could still present problems. Electronic controls are no substitute for normal, good engineering practice.

Danfoss will not be responsible for any goods, or plant components, damaged as a result of the above defects. It is the installer's responsibility to check the installation thoroughly, and to fit the necessary safety devices.

Special reference is made to the necessity of signals to the controller when the compressor is stopped and to the need of liquid receivers before the compressors.

Your local Danfoss agent will be pleased to assist with further advice, etc.