



REFRIGERATION AND
AIR CONDITIONING

Instructions

AK-CM 102

Communication module



080R9298



RI8PQ252

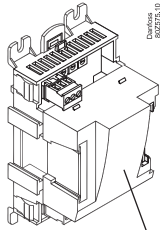

080Z0064

CE
24 V a.c./d.c. 2 VA
 $-20^{\circ} < t_{amb} < 55^{\circ}C$
 $-0^{\circ}F < t_{amb} < 130^{\circ}F$
0 - 95% RH, non condensing
IP10 / VBG4
UL: E357029

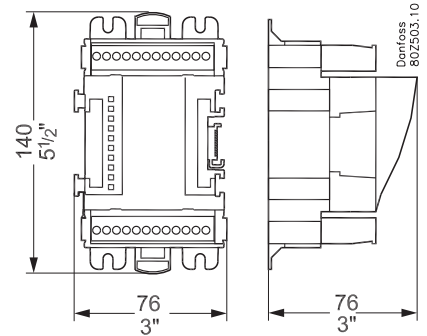

Princip Prinzip Principe

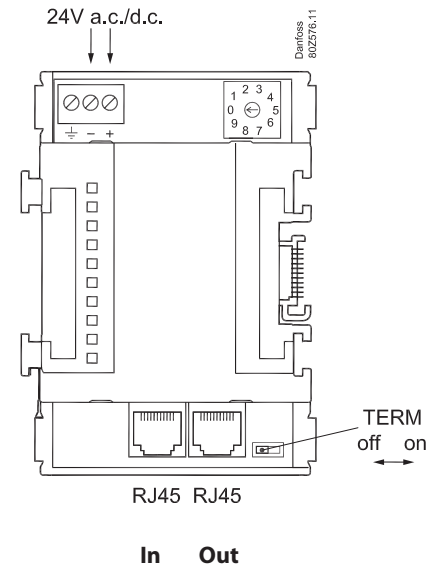
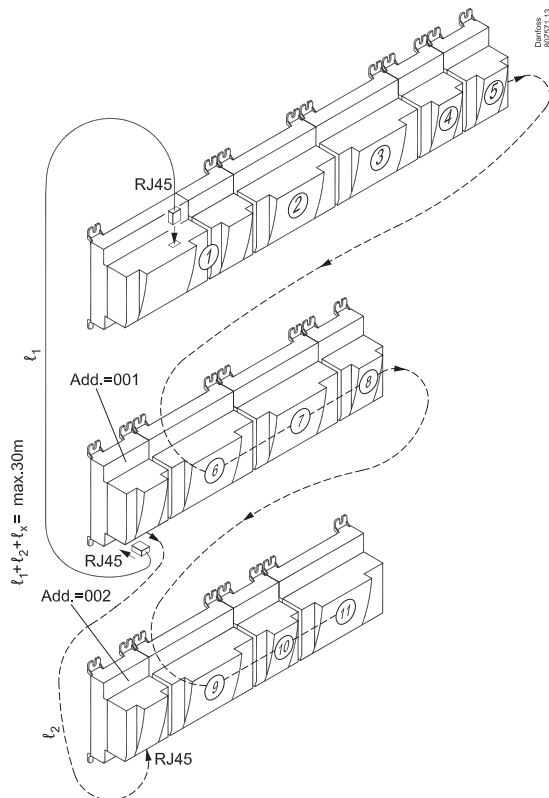

Montering Mounting Montage

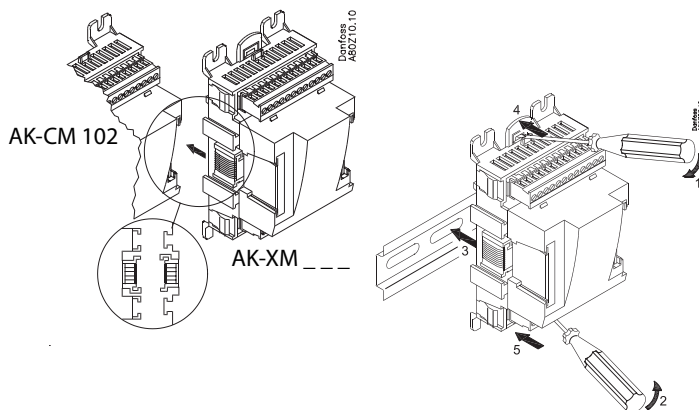

Warning

Ensure power is disconnected before adding or removing modules.

Controller configuration must be carried out when adding or removing modules.

Effektbehov
Power Requirements
Leistungsbedarf
Puissance requise

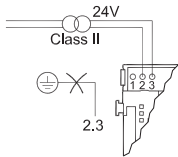

Rev. 001
 802972.12

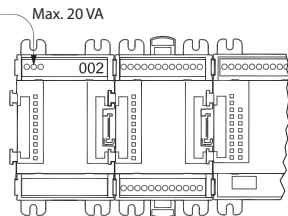
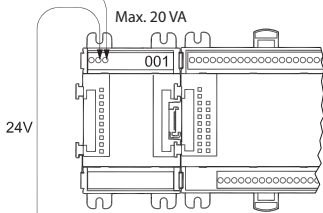
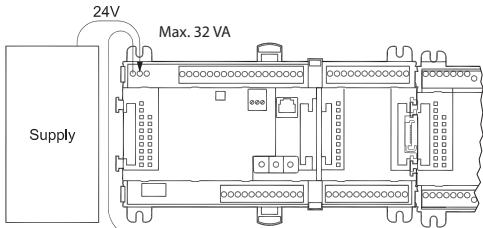

Strømforsyning = 24 V a.c. eller 18-36 V d.c.
 Sørg for, at den yder tilstrækkelig effekt til alle modulopstillingerne.
 Klasse II er påkrævet.
 Klemmerne 2,3 må **ikke** jordes.

Power supply = 24 V a.c. or 18-36 V d.c.
 Insure that it provides sufficient power for all the modules in the lineup.
 Class II is required.
 The terminals 2,3 must **not** be earthed.

Stromversorgung = 24 V a.c. oder 18-36 V d.c.
 Die Stromversorgung muss für sämtliche Module in der Anordnung
 ausreichend sein.
 Klasse II ist erfordert.
 Die Klemmen 2,3 dürfen **nicht** geerdet werden.

Alimentation = 24 V c.a. ou 18-36 V c.c.
 S'assurer que l'alimentation fournit suffisamment de puissance pour
 tous les modules de l'alignement.
 La class II est indiquée.
 Il **ne faut pas** relier les bornes 2,3 à la terre.

Dat kommunikation
Data communication
Datenübertragung
Transmission de données

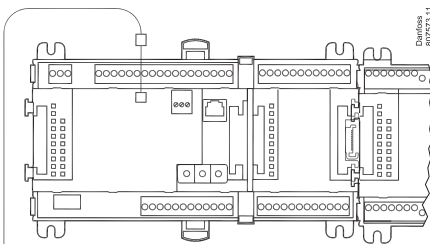

Address
 = 001
TERM
 = on

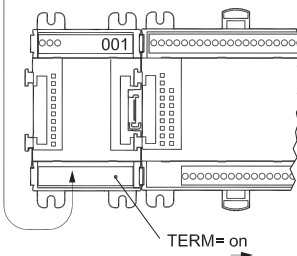

Address
 = 001
TERM
 = off

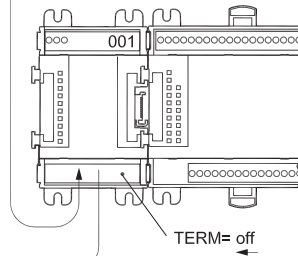
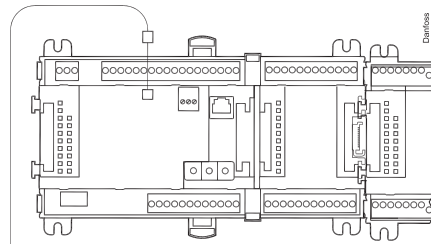

Address
 = 002
TERM
 = on

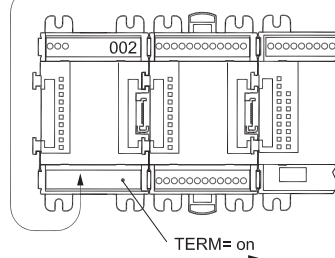

Cable:
 ANSI/TIA 568 B/C CAT5 UTP cable w/ RJ45 connectors

The Product contains electrical components.
 And may not be disposed together with domestic waste.
 Equipment must be separate collected with Electrical and Elec-
 tronic waste. According to local and currently valid legislation.

