

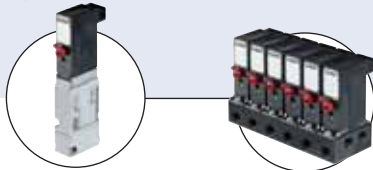

## 3/2-way Flipper Solenoid Valve

- Direct-acting
- 0 to 10 bar
- Low power consumption
- Sub-base connection
- 10mm width per station
- Standard, EEx ia Version

Type 6144 can be combined with...



### Type 6524

Servo-assisted pneumatic valve

### Type 6144

Multiple manifolds (e.g. 6 valves)

Type 6144 is a direct-action 3/2-way solenoid valve designed for neutral gases and liquids. Through the movement between the 2 end positions, the switching element (flipper) seals one of the two opposing valve seats and connects the other to the working port. This movement is caused by the solenoids magnetic field pushing a permanent magnet that is fixed to the flipper element. In addition to its exceptional performance characteristics, the flipper principle is especially marked by its very low switching noise and its low wear level. Furthermore, integrated medium separation enables use above and beyond pneumatic applications. Depending on the case of operation, various flange connections are available that are suitable for both individual and block mounting. Installation advice: The valve must have a minimum distance of 5 mm from other ferromagnetic materials in order to avoid malfunctioning during operating conditions.

### Circuit function C

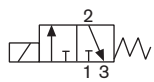

3/2-way valve, direct acting, de-energized port 2 exhausted

### Circuit function D

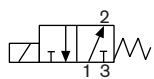

3/2-way valve, direct acting, de-energized port 2 pressurized

Technical data	
<b>Body material</b>	PPS (Polyphenylsulfide)
<b>Seal material</b>	FKM
<b>Media</b>	Compressed air lubricated, oil-free or dry; neutral gases and liquids (5µm filtering); technical vacuum
<b>Media temperature</b>	0 to +55°C
<b>Ambient temperature</b>	0 to +55°C
<b>Port connection</b>	· Bürkert flange · Lateral flange
<b>Electrical connection</b>	Rectangular plug as standard; on request: · Circular plug M8x1 · Flying lead 0.2 mm <sup>2</sup> , 300 mm · Blank connector (5.08 mm)
<b>Type of protection</b>	without Standard version Ex version
<b>Operating voltage</b>	24V/DC <sup>1)</sup> 12V/DC <sup>1)</sup> on request Further voltages on request
<b>Voltage tolerance</b>	±10% <sup>2)</sup> (Further voltages on request)
<b>Nominal power</b>	0.8W
<b>Switching function</b>	Monostable Bistable (impulse) on request
<b>Duty cycle</b>	100% continuous rating
<b>Installation</b>	As required, preferably with actuator upright; 5mm minimum distance to ferromagnetic materials
<b>Insulation class</b>	3 acc. VDE 0580
<b>Protection class</b>	IP 40, IP 65 by flying leads (without hand lever)
<b>Cycling rate</b>	ca. 1000/min
<b>Electrical control</b>	with SPS possible
<b>Response times</b>	Measurement at the valve outlet, at 20°C and 6 bar inlet pressure, according to DIN ISO 12238: Open (Pressure rise 0 to 10%) ca. 8 ms (Standard) ca. 14 ms (Ex version) Close (Pressure rise 100 to 90%) ca. 10 ms (Standard) ca. 18 ms (Ex version)

<sup>1)</sup> Battery voltage; observe polarity as shown on top of the valve

<sup>2)</sup> Max. allowed ripple

## Ordering chart, standard version (other versions on request)

All valves with mounting screws and flange seal; without plug connection (see Accessories)

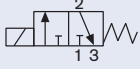
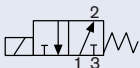
Circuit function	Port connection	Orifice [mm]	Qn value 1-2 air [l/min] <sup>1)</sup>	Qn value 2-3 air [l/min] <sup>1)</sup>	Pressure range <sup>2)</sup> [bar]	Manual override	Voltage [V]	Nominal power [W]	Item no. rectangular plug	Item no. flying leads with 500mm length
<b>C</b>  3/2-way valve NC	Bürkert flange	0.6	7.0	8.5	0-10 <sup>3)</sup>	with	12 24	0.8	182 862 181367	215 686 202 578
	Lateral flange	0.6	6.0	7.5	0-10 <sup>3)</sup>	with	24	0.8	175682	214 196
<b>D</b>  3/2-way valve NO	Bürkert flange	0.6	7.0	8.5	0-10	with	24	0.8	175653	■
	Lateral flange		6.0	7.5					179098	■

<sup>1)</sup> Qn value air [l/min]: Measurement with +20°C, 6 bar pressure on the valve input and 1 bar pressure differential

<sup>2)</sup> Pressure values [bar]: Measured as overpressure to the atmospheric pressure

<sup>3)</sup> Application with vacuum on request

Mounting screws for Bürkert flange: M1.6x5 for Lateral flange: M1.6x20

### i Further versions on request



#### Electrical connection

Electrical connection left or right-sided alternatively. Possible electrical connections are 2 single flying leads, M8x1 round plugs or plug for contacting circuit board.



#### Circuit functions

Circuit function A, B and T



#### Additional

On request, the valve can be delivered with a manual control on the left or right side, but also without.

Version without hand lever and with round plug M8x1 electrical connection or single flying lead has IP65 protection class.

## Ordering chart, Ex version

Approval acc. to II 2G Ex ia IIC T4 T5 T6 PTB01 ATEX 2048 and IECx PTB 07.0063

All valves with rectangular plug, mounting screws and flange seal; without plug connection (see Accessories)

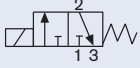
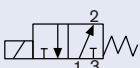
Circuit function	Port connection	Orifice [mm]	Qn value 1-2 air [l/min] <sup>1)</sup>	Qn value 2-3 air [l/min] <sup>1)</sup>	Pressure range <sup>2)</sup> [bar]	Manual override	Resistance at 20°C +/-4% [Ω]	Minimum holding current [mA]	Item no.
<b>C</b>  3/2-way valve NC	Bürkert Flange	0.6	7	8.5	0-7	yes	320	29	175 657
	Bürkert Flange	0.6	7	8.5	0-7	yes	510	23	175 656
<b>D</b>  3/2-Wege-Ventil NO	Bürkert Flange	0.6	7	8.5	0-7	yes	320	29	183 550

<sup>1)</sup> Qn value air [l/min]: Measurement with +20°C, 6 bar pressure on the valve input and 1 bar pressure differential

<sup>2)</sup> Pressure values [bar]: Measured as overpressure to the atmospheric pressure

<sup>3)</sup> Vacuum up to 10 bar on request

Mounting screws for Bürkert flange: M1.6x5 for Lateral flange: M1.6x20

#### Electrical data:

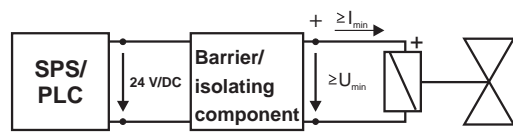

Functional values for valve switching function at 0 °C to +55°C	Permitted maximum values/ value pairs acc. to operating instructions
Min. holding current: 29mA	U <sub>i</sub> 35V
Nominal coil resistance 320Ω ±4%	I <sub>i</sub> 0.9A
Min. Holding current: 23mA	
Nominal coil resistance 510Ω ±4%	

## Ordering chart for accessories

Device	Characteristics	Item no.
<b>Bürkert flange</b>		
Single manifold	for Bürkert flange under M3	639 873
Manifold 2-fold	for Bürkert flange, M5	641 911
Manifold 4-fold	for Bürkert flange, M5	641 912
Manifold 6-fold	for Bürkert flange, M5	639 874
Blanking plate kit	for multiple manifolds, Bürkert flange	645 512
<b>Lateral flange</b>		
Single manifold	for lateral flange, M3	639 234
Manifold 2-fold	for lateral flange, M5	641 915
Manifold 4-fold	for lateral flange, M5	641 916
Manifold 6-fold	for lateral flange, M5	639 235
Blanking plate kit	for multiple manifolds, lateral flange	645 513
<b>Tube connector plug</b>		
Screw in fitting connection	Brass, straight, for M3 and tube - $\varnothing$ 4 mm	782 534
Screw in fitting connection	Brass, straight, for M5 and tube - $\varnothing$ 4 mm	787 810

Options for the electrical connection, rectangular plug as standard, other connections on request

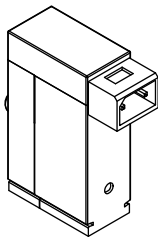

**Rectangular plug**  
Raster 5.08 mm

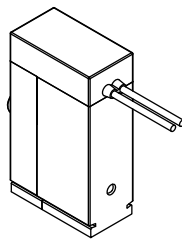

**2 flying leads**  
0.2 mm<sup>2</sup>, 300 mm long

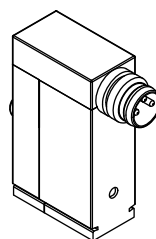

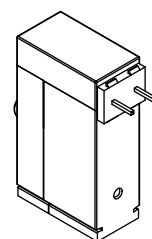

**Circular plug**  
M8x1, 3-pin



**Blank connector**  
Raster 5.08 mm  
(e.g. for board mounted connection 0,63 x 0,63)

## Cable plug, Type 2505

	<b>Type 2505, cable version</b>	<b>Item no.</b>
	with 3m	133 486
	with 5m	167 494
	<b>Type 2505, flying lead version</b>	<b>Item no.</b>
	with 300 mm	644 068
	with 600 mm	162 144

Dimensions [mm]

Type 6144 with lateral flange

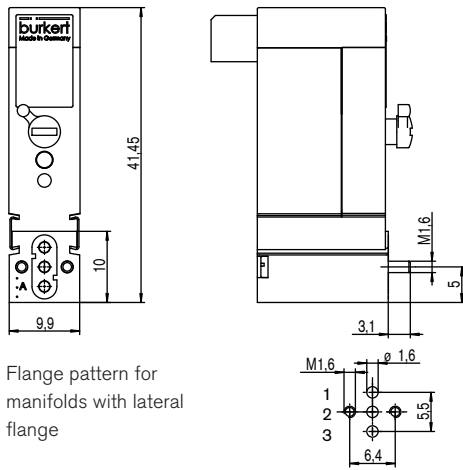

Flange pattern for manifolds with lateral flange

The valve can optionally be delivered with manual override on the left or right hand side (standard: opposite the electrical connection).

Single manifold for lateral flange

Material: Aluminium, M3 threaded

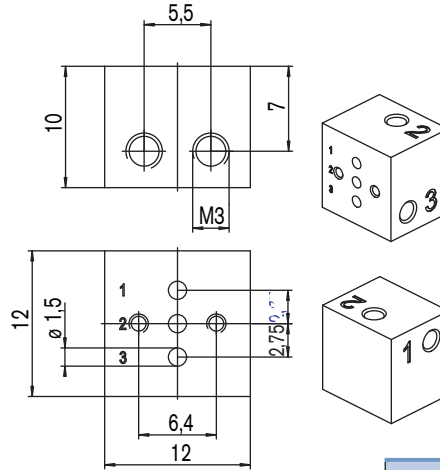

Item no.

639 234

Multiple manifolds for lateral flange

Material: Aluminium, M5 threaded

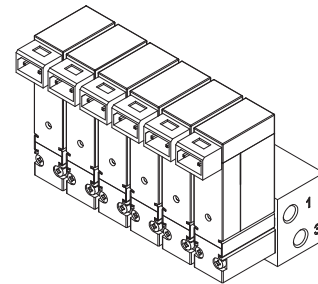
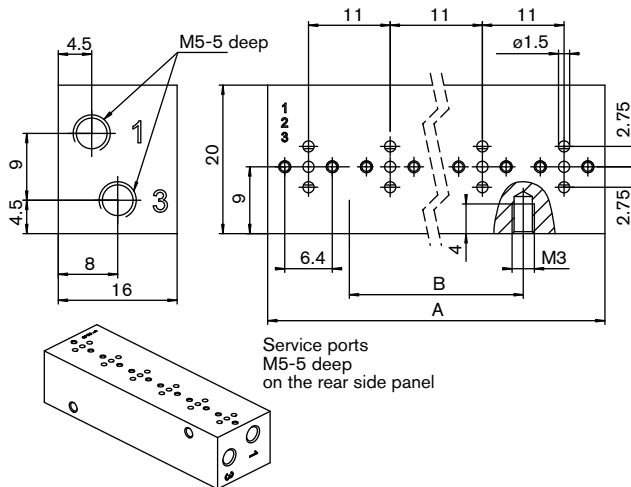

	A	B	Item no.
2 valves	22	-	641 915
4 valves	44	22	641 916
6 valves	66	44	639 235
8 valves	88	66	672 676
Blanking plate kit			645 513

Dimensions [mm] (cont.)

Type 6144 with Bürkert flange

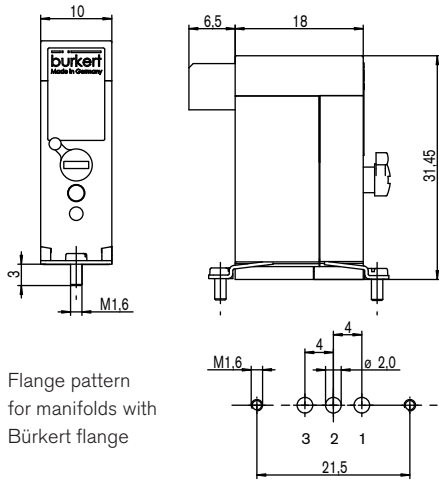

Flange pattern  
for manifolds with  
Bürkert flange

The valve can optionally be delivered with manual over-ride on the left or right hand side (standard: opposite the electrical connection).

Single manifold for Bürkert flange

Material: Aluminium, M3 threaded

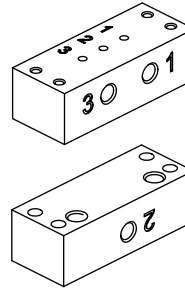
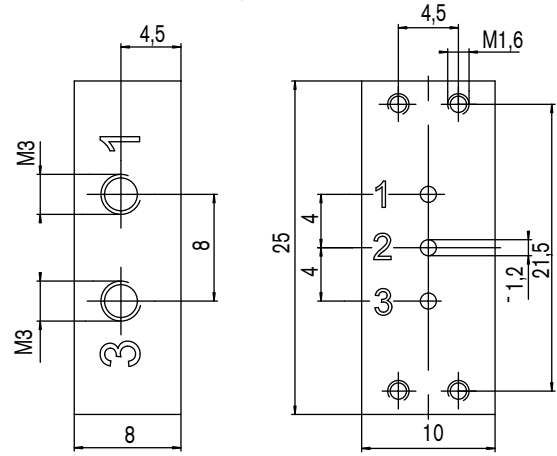

Item no.

639 873

Multiple manifolds for Bürkert flange,  
Material: Aluminium, M5 threaded

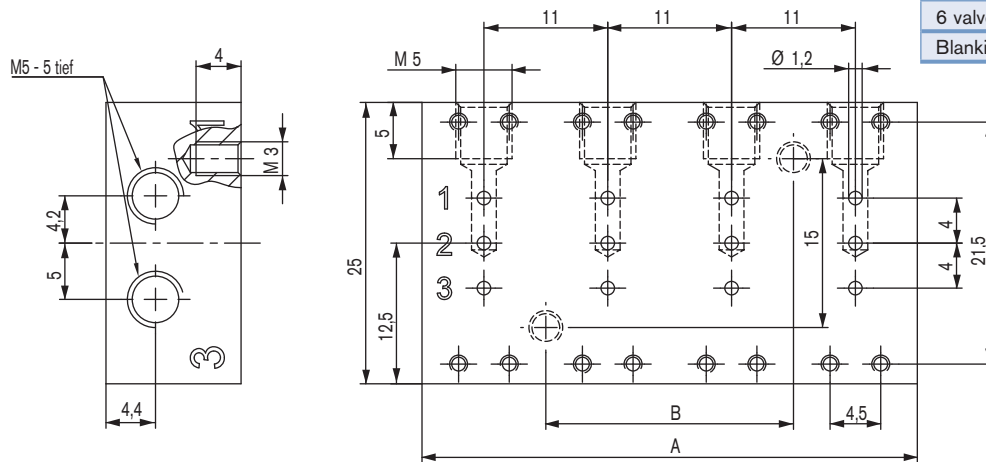

	A	B	Item no.
2 valves	22	-	641 911
4 valves	44	22	641 912
6 valves	66	44	639 874
Blanking plate kit			645 512

In case of special application conditions,  
please consult for advice.

We reserve the right to make technical changes without notice.  
© Christian Bürkert GmbH & Co. KG

1003/5\_EU-en\_00895023