



Type 2301 can be combined with...



Type 8692/8693

Positioner / Process
Controller TopControl



Type 8694

Positioner Basic
TopControl



Type 8696

Positioner Basic
TopControl



Type 8792/93

Positioner / Process
Controller SideControl
Remote



Type 8791

Positioner Basic
SideControl Remote



Pneumatic operated 2-way Globe Control Valve ELEMENT

- Excellent control characteristics
- High cycle life and maintenance-free operation
- Flow optimised body in stainless steel
- Several Kvs value per port size due to removable trim kit
- Control units can be mounted directly without external tubing

In line with Bürkert's philosophy the construction of the 2301 globe valve fulfils tough criteria for process environments. Unrivalled cycle life and sealing integrity is guaranteed by the proven self adjusting spindle packing with exchangeable V-seals.

Each globe valve body can be fitted with up to five sizes of trim sets. These parabolic trims provide a reliable and repeatable characteristic to vary the flow. The control cones are available in either stainless steel or with a durable PTFE seal or PEEK seal for tight shut-off. Leakage class III, IV or VI are available.

The design enables the easy integration of automation modules whether they are digital electropneumatic positioner or process controller.

The fully integrated system has a compact and smooth design, integrated pneumatic lines, IP65/67 protection class and superior chemical resistance.

Technical data	
Kvs values	0.1...140 m ³ /h
Port / Seat size (orifice)	DN10...DN100 / DN3...DN100
Pressure stage	PN 16 (Standard) ; PN 25 (on request)
Port connections	<ul style="list-style-type: none"> ▪ Flange ▪ Thread ▪ Weld ends ▪ Clamp
Medium	Neutral gases, water, alcohol, oils, fuel, hydraulic mediums, salt solution, alkali solutions, organic solvents, steam, optional fuel gas (EC Gas Appliances Directive 2009/142/EG)
Viscosity	max. 600 mm ² /s
Medium temperature	-10...+185°C (Stainless Steel seal /Stainless Steel cone) -10...+185°C (PEEK seal/Stainless Steel cone) -10...+130°C (PTFE seal /Stainless Steel cone)
Ambient temperature	0...+80°C (remote version) 0...+55°C (when used with positioner or process controllers)
Seat leakage gemäß IEC 534-4/EN 1349	Shut-off class III and IV for St.st./St.st. Shut-off class VI for PTFE/St.st. and PEEK/St. st. (see details in ordering chart)
Safety position	A: normally closed by spring action (NC) B: normally open by spring action (NO)
Control medium	instrument air acc. DIN ISO 8573-1
Approval and Conformity	FDA, EGV 1935/2004; (ATEX and DVGW on request)

Content

Valve specifications Type 2301		System Continuous ELEMENT 8802_GD	
	Technical data		System Combination information
	Dimensions		Dimensions
	Ordering chart		Request for quotation
	p. 1 ... 4		p. 5...7
	p. 8...12		p. 8
	p. 13...16		p. 17...19

Technical data, continued

Flow direction below the seat, Control function A (NC)

Port size (tube)		Seat size		Actuator size \varnothing	Operating pressure Seal/control cone		Pilot pressure	Leakage Class Seal/control cone		Kv values at stroke [m ³ /h]						Kvs values [m ³ /h]			
[mm]	[inch]	[mm]	[inch]		St. st. or PTFE/St. st. [bar]	PEEK/St. st. [bar]		PTFE or PEEK/St. st.	St. st./St. st.	5%	10%	30%	50%	70%	90%				
10	3/8	3	0.12	50	16	10	5.5...7	-	IV	0.001	0.003	0.015	0.037	0.065	0.090	0.1			
				70						0.00	0.02	0.10	0.19	0.27	0.33	0.35			
		4	0.16	50						0.04	0.05	0.16	0.27	0.36	0.44	0.5			
				70						VI	0.05	0.12	0.48	0.76	0.98	1.13	1.2		
		6 ²⁾	0.24	50							0.01	0.007	0.045	0.16	0.41	1.08	1.25		
				70						0.06	0.07	0.12	0.26	0.61	1.50	2.0			
		8	0.31	50						0.09	0.11	0.19	0.48	1.00	2.30	2.7			
10	0.39	50																	
15	1/2	3	0.12	50	16	10	5.5...7	-	IV	0.001	0.003	0.015	0.037	0.065	0.090	0.1			
				70						0.005	0.015	0.100	0.190	0.265	0.325	0.350			
		4	0.16	50						0.04	0.05	0.16	0.27	0.36	0.44	0.5			
				70						VI	0.05	0.12	0.48	0.76	0.98	1.13	1.1		
		6 ²⁾	0.24	50							0.005	0.007	0.045	0.160	0.410	1.080	1.250		
				70						0.07	0.08	0.13	0.27	0.63	1.60	2.1			
		8	0.31	50						0.09	0.11	0.19	0.49	1.10	2.50	3.1			
10	0.39	50	0.14	0.17	0.35	0.80	1.80	3.70	4.3										
20	3/4	10	0.39	50	16	10	5.5...7	VI	IV	0.11	0.12	0.20	0.52	1.20	2.60	3.2			
				70						0.14	0.17	0.35	0.80	1.80	4.00	5.2			
		15	0.29	50						10	-	III	0.20	0.25	0.45	1.10	2.40	5.20	7.1
25	1	15	0.29	50	16	10	5.5...7	VI	IV	0.14	0.17	0.35	0.80	1.80	4.10	5.3			
				70						0.20	0.25	0.47	1.10	2.50	5.40	7.2			
		20	0.79	50						10	-	III	0.20	0.25	0.47	1.10	2.50	5.40	7.2
				70						16	10	III	0.35	0.38	1.00	2.20	5.10	9.40	12.0
		25	0.98	50						5	-	III	0.35	0.38	1.00	2.20	5.10	9.40	12.0
70	12	7	IV	0.35	0.38	1.00	2.20	5.10	9.40	12.0									
90	16	10	IV	0.35	0.38	1.00	2.20	5.10	9.40	12.0									
32	1 1/4	20	0.79	90	16	10	5.5...7	VI	IV	0.21	0.24	0.45	0.85	1.75	3.75	5.5			
				130						0.22	0.25	0.50	1.10	2.50	5.80	8.0			
		25	0.98	90						0.38	0.45	0.95	1.95	4.00	7.40	9.9			
				130						0.40	0.47	1.10	2.50	5.40	10.3	13.0			
		32	1.3	90						0.45	0.58	1.10	2.50	4.90	10.1	13.4			
130	0.48	0.60	1.30	3.10	6.80	14.0	17.8												
40	1 1/2	25	0.98	90	16	10	5.5...7	VI	IV	0.38	0.48	0.95	2.00	4.10	7.90	10.3			
				130						0.40	0.50	1.10	2.60	5.60	10.7	13.6			
		32	1.3	90						0.45	0.55	1.10	2.50	4.95	10.8	14.4			
				130						0.48	0.60	1.30	3.20	6.90	15.0	20.2			
		40	1.6	90						0.55	0.67	1.50	3.15	6.50	13.6	17.5			
130	0.60	0.70	1.70	4.00	9.20	18.2	23.8												
50	2	32	1.3	90	16	10	5.5...7	VI	IV	0.45	0.56	1.10	2.50	4.95	11.4	15.3			
				130						0.48	0.60	1.30	3.20	6.90	16.0	21.0			
		40	1.6	90						0.57	0.68	1.45	3.15	6.40	13.8	18.0			
				130						0.60	0.70	1.70	4.00	9.20	18.9	24.6			
		50	2.0	90						0.85	1.05	2.55	5.35	11.4	21.7	28.0			
130	0.90	1.10	2.90	6.80	15.5	29.3	37.0												
65	2 1/2	40	1.6	130	16 (15°)	10	5.5...7	VI	IV	0.65	0.75	1.8	4.3	10.4	22	29.0			
				50						2.0	130	1.0	1.2	3.1	6.7	16.0	35.0	45.0	
		65	2.6	130						1.6	2.0	5.0	13.5	33.0	56.0	65.0			

Technical data, continued

Flow direction below the seat, Control function A (NC)

Port size (tube)		Seat size		Actuator size \varnothing	Operating pressure Seal/control cone		Pilot pressure	Leakage Class Seal/control cone		Kv values at stroke [m ³ /h]						Kvs values [m ³ /h]		
[mm]	[inch]	[mm]	[inch]		St. st. or PTFE/St. st. [bar]	PEEK/St. st. [bar]		PTFE or PEEK/St. st.	St. st./St. st.	5%	10%	30%	50%	70%	90%			
80	3	50	2.0	130	16 (12.5 ¹⁾)	10	5.5...7	VI	IV	1.0	1.2	3.4	8.3	19.0	35.0	45.0		
		65	2.6	130			5.6...7					1.6	2.0	5.0	13.0	35.0	61.0	73.0
		80	3.2	130	10	6					III	2.5	3.4	10.7	27.0	58.0	87.0	100.0
100	4	65	2.6	130	16 (10 ²⁾)	10	5.6...7	VI	IV	1.4	1.8	5.0	15.0	37.0	64.0	77.0		
		80	3.2	130	10	6					III	2.2	3.1	10.3	30.0	66.0	97.0	110.0
		100	3.9	130	6	-						3.8	5.2	15.0	46.5	90.0	128.0	140.0

¹⁾ low flow cone

²⁾ linear flow curve

³⁾ equal percentage flow curve

* acc. to the Pressure Equipment Directive 97/23/EC for compressible mediums in Group 1 (hazardous gases and vapours in accordance with Article 3, Section 1.3, letter a, first dash)

Flow curve and description

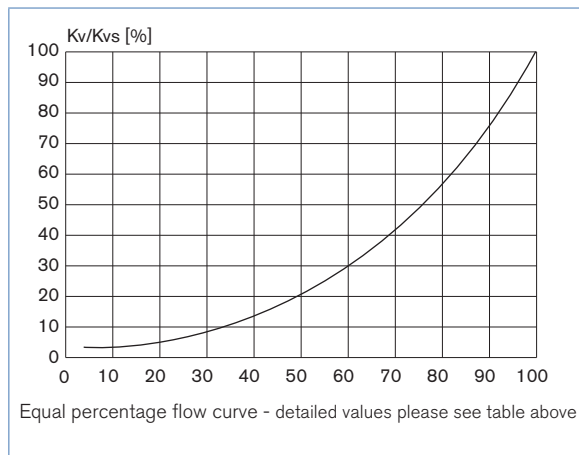

Remarks on the flow characteristic

- Linear cone for orifice DN3 to DN6
- Equal percentage cone for orifice DN8 to DN100 (DN6 optional with equal percentage cone)
- Flow characteristic runs within DIN EN 60534-2-4
- Theoretical control ratio (Kvs/Kvo) for drive size 70/90/130:
 - 50:1 for the orifices DN8 to DN100
 - 25:1 for the orifice DN6
 - 10:1 for the orifice DN3 and DN4
- KVR value at 5% of stroke for DN > 10 mm
- KVR value at 10% of stroke for DN ≤ 10 mm
- The drive size 70 has relative to the drive size 50 better control quality and is therefore preferable to use

(KVR value = smallest Kv value at which the gradient tolerance to DIN EN 60534-2-4 is still complied with)

Control pressure

Control pressure	min.	max.
Control function A (NC), normally closed by spring force	5.6 bar 560 kPa 81 PSI	7 bar 700 kPa 102 PSI
Control function B (NO), normally open by spring force	see pressure charts	7 bar 700 kPa 102 PSI

Selection chart for seat sealing

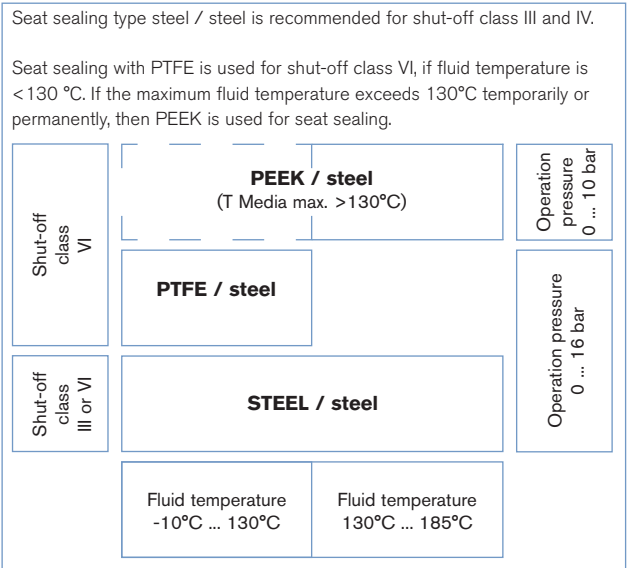

Pressure Charts with control function B (normally open, NO)

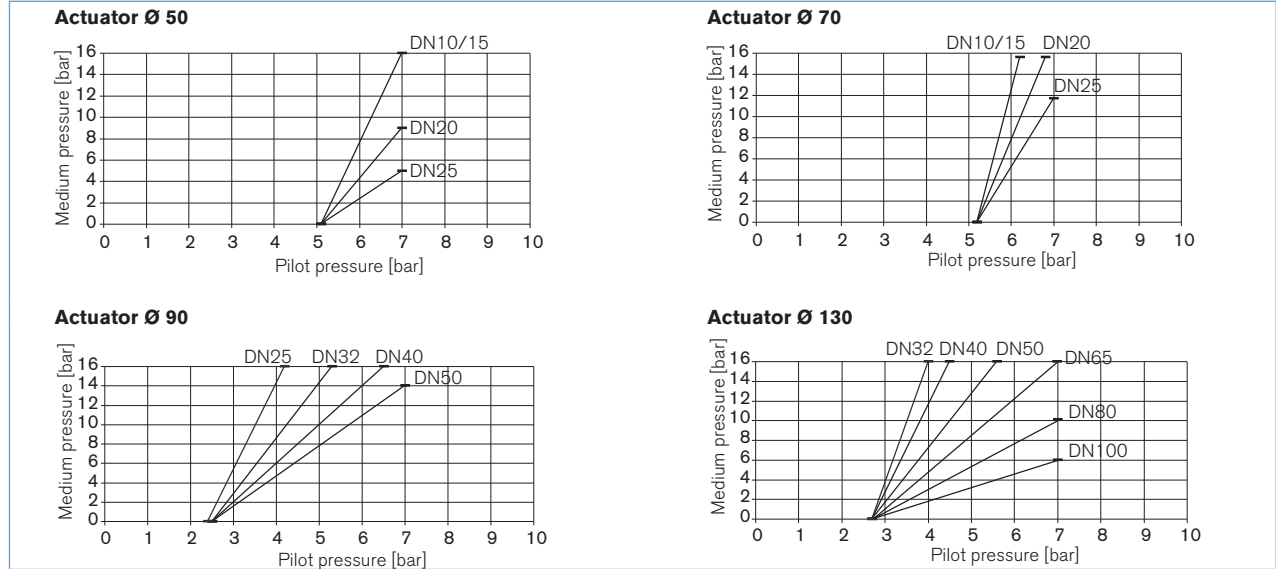

Design and materials view

The detailed parts and materials are displayed in the following picture:

Note: as the globe control valve Type 2301 could be delivered with miscellaneous port connection (flange, thread, weld ends and clamp), there will not be represented on the picture, but are made with same material as the valve body.

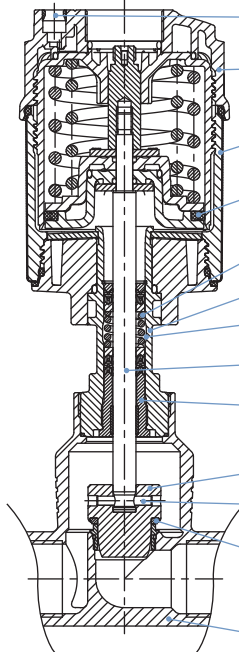
2301 globe control valve	Description	Material
	Pilot air ports	Push-in connector PP
	Actuator	PPS
	Cover	Stainless steel 1.4561 (316Ti)
	Piston seal	FKM
	Spring	Stainless steel 1.4310
	Tube	Stainless steel 1.4401 (316)
	Spindle packing	PTFE
	Spindle	Stainless steel 1.4401 (316) / 1.4404 (316L)
	Spindle guidance	Stainless steel 1.4404 (316L)
	Control cone	Stainless steel 1.4571
	Spring straight pin	Stainless steel 1.4310
	Control cone seal	Stainless steel 1.4571 / PTFE or PEEK disc for soft seat sealing
	Valve body	Cast stainless steel 316L

Decentralised automation - valve system Continuous ELEMENT Type 8802-GD

The **globe control valve Type 2301** can be combined with our comprehensive range of positioners and controllers, specially optimised for the decentralised automation of pneumatically controlled valve, to lead a **valve system Continuous ELEMENT Type 8802-GD**.

The range of control unit consists of:

- a digital electropneumatic Positioner/Process Controller **Type 8692/8693** (for valve actuator sizes \varnothing 70/90/130 mm)
- a digital electropneumatic Positioner Basic **Type 8694** (for valve actuator sizes \varnothing 70/90/130 mm)
- a digital electropneumatic Positioner Basic **Type 8696** (for valve actuator size \varnothing 50 mm).
- an electropneumatic Positioner SideControl **Type 8792** or an electropneumatic Process Controller **Type 8793** (for valve actuator sizes \varnothing 70/90/130 mm) and a remote sensor **Type 8798**
- an electropneumatic Positioner SideControl Basic **Type 8791** (for valve actuator sizes \varnothing 70/90/130 mm) and a remote sensor **Type 8798**

For the configuration of further valve systems please use the "Request for quotation" on p. 17 [go to page](#)

You order two components and receive a complete assembled and certified valve.

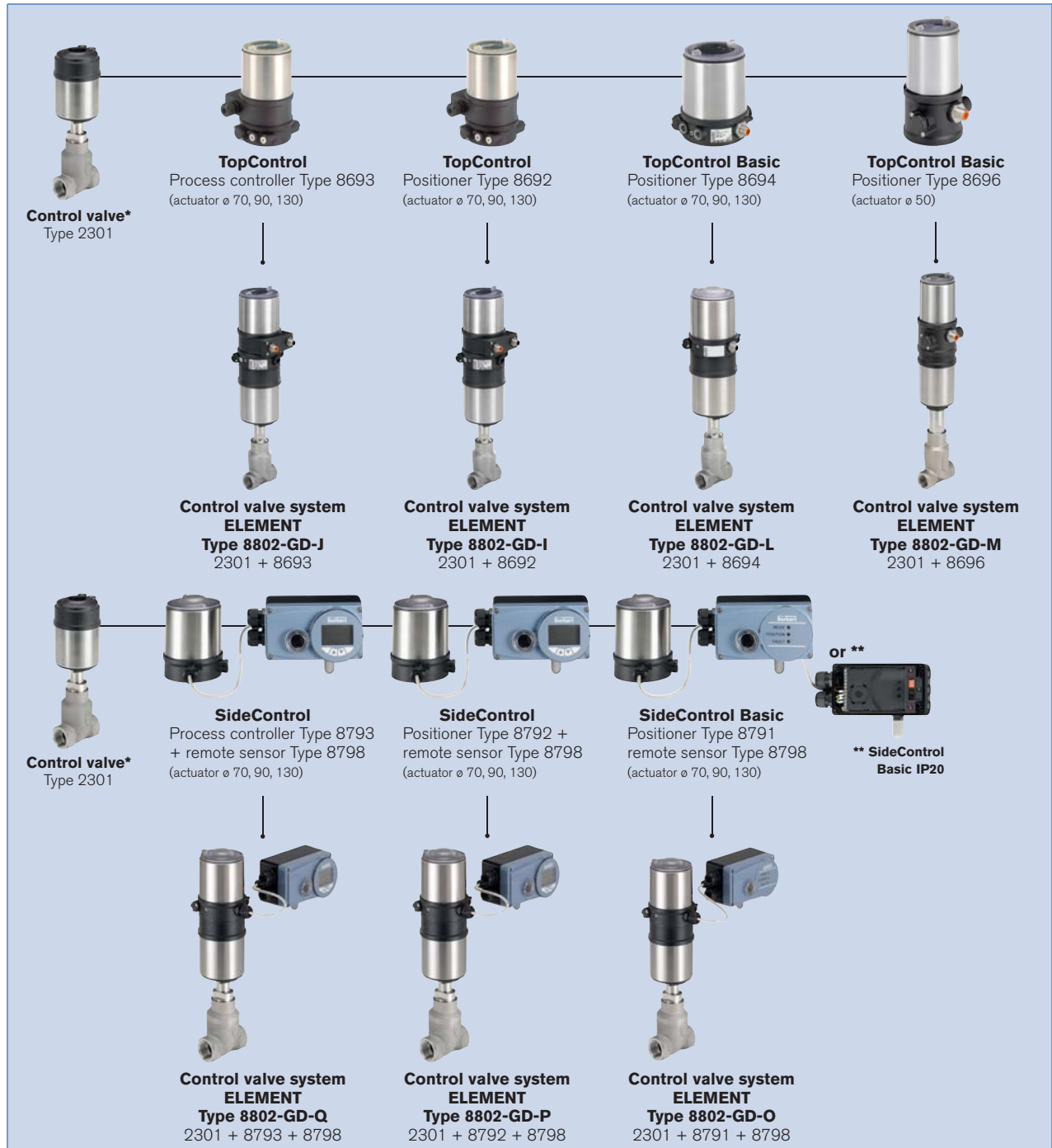

* Example with thread port connection

Decentralised automation - valve system Continuous ELEMENT Type 8802-GD, continued.

Positioners and controllers information

When you click on the orange box "More info." below, you will come to our website for the resp. product where you can download the datasheet.

Process Controller TopControl Type 8693 (actuator size: 70/90/130)

More
info.



PROFIBUS
DeviceNet™

The intelligent process controller Type 8693 is designed for integrated mounting on pneumatic actuators from the process control valve series Type 23xx/2103 and specifically for the requirements of hygienic process environments. The initialisation of the process controller and positioners can be automatically performed using Tune-Functions. The easy handling and the selection of additional software functions and parameterisation are done either on a big graphic display and keypad. Device configuration and parameterisation can be carried out easily by the Bürkert-COMMUNICATOR software tool via a PC interface.

Features:

- Hygienic stainless steel design according to EHEDG guidelines
- Contact and wearless analog position sensor
- Universal positioning system for single and double-acting actuators
- Highly dynamic positioning system without internal control air consumption
- Integrated diagnostic functions for valve monitoring
- Ensuring failure of the electrical or pneumatic power supply
- Profibus DPV1 or DeviceNet Field bus communication (optional)

Customer Benefits:

- Intuitive and easy operation via the large graphic display with backlight and keypad
- Automatic initialisation of positioners and process controllers using TUNE function
- High plant availability through increased drive life by spring chamber ventilation
- Guaranteed reliability and services can be scheduled through valve monitoring and diagnosis
- Outstanding price/performance ratio

Positioner TopControl Type 8692 (actuator size: 70/90/130)

More
info.



PROFIBUS
DeviceNet™

The intelligent electro-pneumatic positioner Type 8692 is designed for integrated mounting on pneumatic actuators from the process control valve series Type 23xx/2103 and specifically for the requirements of hygienic process environments. The initialisation of the positioners can be automatically performed using Tune-Functions. The easy handling and the selection of additional software functions and parameterisation are done either on a big graphic display and keypad. Device configuration and parameterisation can be carried out easily by the Bürkert-COMMUNICATOR software tool via a PC interface.

Features:

- Hygienic stainless steel design according to EHEDG guidelines
- Contact and wearless analog position sensor
- Universal positioning system for single and double-acting actuators
- Highly dynamic positioning system without internal control air consumption
- Integrated diagnostic functions for valve monitoring
- Ensuring failure of the electrical or pneumatic power supply
- Profibus DPV1 or DeviceNet Field bus communication (optional)

Customer Benefits:

- Intuitive and easy operation via the large graphic display with backlight and keypad
- Automatic initialisation of positioners and process controllers using TUNE function
- High plant availability through increased drive life by spring chamber ventilation
- Guaranteed reliability and services can be scheduled through valve monitoring and diagnosis

Positioner TopControl Basic Type 8694 (actuator size: 70/90/130)

More
info.



The compact positioner Type 8694 is designed for integrated mounting on pneumatic actuators from the process control valve series Type 23xx/2103 and specifically for the requirements of hygienic process environments. The operation and parameterisation are done via push buttons and DIP switches. Device configuration and parameterisation can be carried out easily by the Bürkert-COMMUNICATOR software tool via a PC interface.

Features:

- Hygienic stainless steel design according to EHEDG guidelines
- Contact and wearless analog position sensor
- Universal positioning system for single and double-acting actuators
- AS-Interface Field bus communication

Customer Benefits:

- Simple design
- Simple and safe start-up by teach function
- High plant availability through increased drive life by spring chamber ventilation
- Little space requirement in the plant piping

Positioner TopControl Basic Type 8696 (actuator size: 50)

More
info.



The compact positioner Type 8696 is designed for integrated mounting on pneumatic actuators from the process control valve series Type 23xx/2103 and specifically for the requirements of hygienic process environments. The operation and parameterisation are done via push buttons and DIP switches. Device configuration and parameterisation can be carried out easily by the Bürkert-COMMUNICATOR software tool via a PC interface.

Features:

- Hygienic stainless steel design according to EHEDG guidelines
- Contact and wearless analog position sensor
- Universal positioning system for single and double-acting actuators

Customer Benefits:

- Simple design
- Simple and safe start-up by teach function
- High plant availability through increased drive life by spring chamber ventilation
- Little space requirement in the plant piping

Decentralised automation - valve system Continuous ELEMENT Type 8802-GD, continued.

Positioners and controllers information

When you click on the orange box "More info." below, you will come to our website for the resp. product where you can download the datasheet.

Process Controller SideControl Type 8793
with remote sensor Type 8798
(actuator size: 70/90/130)

[More info.](#) [More info.](#)



PROFIBUS

The intelligent digital positioner/process controller Type 8793 is designed for mounting on lift or swivel drives with standardization in accordance with IEC 534-6 or VDI/VDE 3845 designed for demanding control tasks. The variant with the remote sensor Type 8798 is used to control Bürkert process control valves. The operation is done on a graphic display with backlight. The initialization of the process controller and positioners can be automatically performed using Tune-Function. Here, the type of control system is automatically detected and determines the appropriate controller structure with the corresponding optimal parameter set.

Features:

- Backlit graphic display with keypad
- Compact and robust design
- Adaption acc. to IEC534-6 and VDI/VDE 3845 for lift and swivel drives or as remote version together with Bürkert Process valves
- Universal positioning system for single and double-acting actuators
- Integrated diagnostic functions for valve monitoring
- Profibus DPV1 or DeviceNet Field bus communication (optional)

Customer Benefits:

- Automatic initialization of positioners and process controllers using TUNE function
- Valve monitoring and diagnosis through integrated diagnostic functions
- No air consumption in steady state condition
- Intuitive and easy operation via the large graphic display with backlight and keypad (Intuitive and simple operating concept)

Positioner SideControl Type 8792
with remote sensor Type 8798
(actuator size: 70/90/130)

[More info.](#) [More info.](#)



PROFIBUS

The intelligent digital positioner Type 8792 is designed for mounting on lift or swivel drives with standardization in accordance with IEC 534-6 or VDI/VDE 3845 designed for demanding control tasks. The variant with the remote sensor Type 8798 is used to control Bürkert process control valves. The operation is done on a graphic display with backlight. The initialization of the process controller and positioners can be automatically performed using Tune-Function. Here, the type of control system is automatically detected and determines the appropriate controller structure with the corresponding optimal parameter set.

Features:

- Backlit graphic display with keypad
- Compact and robust design
- Adaption acc. to IEC534-6 and VDI/VDE 3845 for lift and swivel drives or as remote version together with Bürkert Process valves
- Universal positioning system for single and double-acting actuators
- Integrated diagnostic functions for valve monitoring
- Profibus DPV1 or DeviceNet Field bus communication (optional)

Customer Benefits:

- Automatic initialization of positioners and process controllers using TUNE function
- Valve monitoring and diagnosis through integrated diagnostic functions
- No air consumption in steady state condition
- Intuitive and easy operation via the large graphic display with backlight and keypad (Intuitive and simple operating concept)

Positioner SideControl Basic Type 8791
with remote sensor Type 8798
(actuator size: 70/90/130)

[More info.](#) [More info.](#)



ASi

The positioner Type 8791 is designed for mounting on lift or swivel drives with standardization in accordance with IEC 534-6 or VDI/VDE 3845 designed for simple control tasks. The variant with the remote sensor Type 8798 is used to control Bürkert process control valves. All operating elements are located inside the housing.

Features:

- Simple design
- Adaption acc. to IEC534-6 and VDI/VDE 3845 for lift and swivel drives or as remote version together with Bürkert Process valves
- Universal positioning system for single and double-acting actuators for valve monitoring
- AS-Interface Field bus communication

Customer Benefits:

- Easy commissioning
- No air consumption in steady state condition
- Simple device for simple control tasks

Positioner SideControl Basic IP20 Type 8791
mit remote sensor Type 8798
(actuator size: 70/90/130)

[More info.](#) [More info.](#)



ASi

The positioner Type 8791 is designed for mounting on lift or swivel drives with standardization in accordance with IEC 534-6 or VDI/VDE 3845 designed for simple control tasks. The variant with the remote sensor Type 8798 is used to control Bürkert process control valves. All operating elements are located inside the housing.

Features:

- Simple design
- Adaption acc. to IEC534-6 and VDI/VDE 3845 for lift and swivel drives or as remote version together with Bürkert Process valves
- Universal positioning system for single and double-acting actuators for valve monitoring
- AS-Interface Field bus communication

Customer Benefits:

- Easy commissioning
- No air consumption in steady state condition
- Simple device for simple control tasks

Dimensions [mm] - Valve Continuous ELEMENT Type 2301 and valve system Continuous ELEMENT

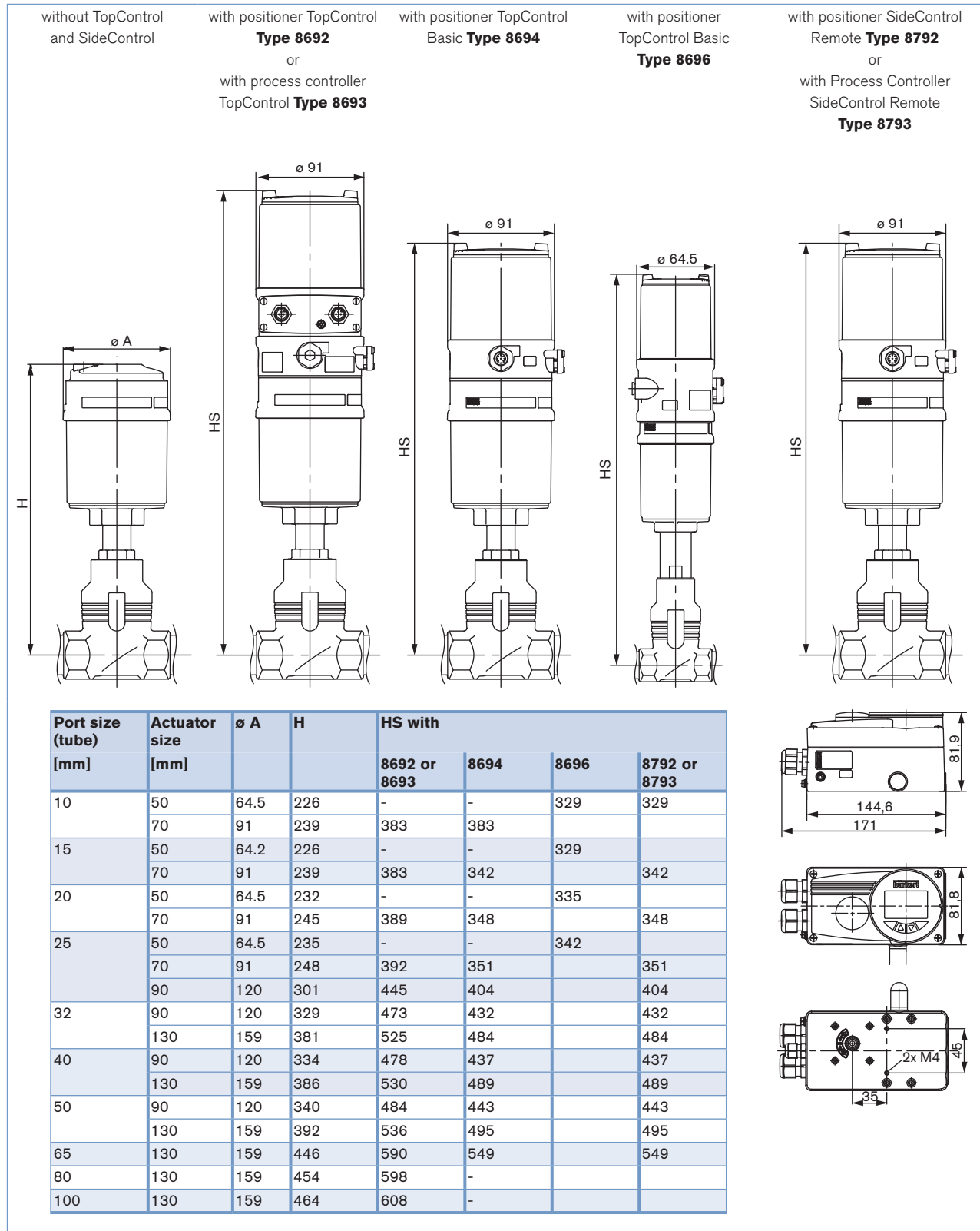

Dimensions [mm] - Body valve Continuous ELEMENT Type 2301

Flange port connection

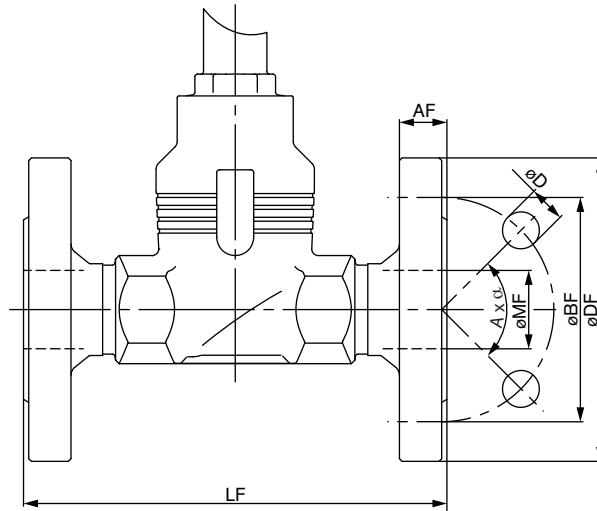

DIN EN 1092, JIS 10K

Port size (tube) [mm]	Actuator size [mm]	DIN EN 1092 FTF Series 1 acc. to DIN EN 558-1						JIS 10K FTF Series 10 acc. to DIN EN 558-2					
		ø DF	LF	ø BF	AF	ø D	ø MF	ø DF	LF	ø BF	AF	ø D	ø MF
10	50	90	130	60	16	14	13.6	-	-	-	-	-	-
	70	90	130	60	16	14	13.6	-	-	-	-	-	-
15	50	95	130	65	16	14	18.1	95	108	70	12	15	18.1
	70	95	130	65	16	14	18.1	95	108	70	12	15	18.1
20	50	105	150	75	18	14	23.7	100	117	75	14	15	23.7
	70	105	150	75	18	14	23.7	100	117	75	14	15	23.7
25	50	115	160	85	18	14	29.7	125	127	90	14	19	29.7
	70	115	160	85	18	14	29.7	125	127	90	14	19	29.7
	90	115	160	85	18	14	29.7	125	127	90	14	19	29.7
32	90	140	180	100	18	18	38.4	135	140	100	16	19	38.4
	130	140	180	100	18	18	38.4	135	140	100	16	19	38.4
40	90	150	200	110	18	18	44.3	140	165	105	16	19	44.3
	130	150	200	110	18	18	44.3	140	165	105	16	19	44.3
50	90	165	230	125	20	18	56.3	155	203	120	16	19	56.3
	130	165	230	125	20	18	56.3	155	203	120	16	19	56.3
65	130	185	290	145	22	18	66	175	216	140	18	19	72
80	130	200	310	160	24	18	81	185	241	150	18	19	84
100	130	235	350	190	24	22	100	210	292	175	18	19	109

ANSI B 16.5

Port size (tube) [inch]	Actuator size [mm]	ANSI B 16.5 Class 150 FTF Series 37 acc. to DIN EN 558-2					
		ø DF	LF	ø BF	AF	ø D	ø MF
1/2	50	89	184	60.5	11.2	15.7	15.7
	70	89	184	60.5	11.2	15.7	15.7
3/4	50	99	184	69.9	12.7	15.7	20.8
	70	99	184	69.9	12.7	15.7	20.8
1	50	108	184	79.2	14.2	15.7	26.7
	70	108	184	79.2	14.2	15.7	26.7
	90	108	184	79.2	14.2	15.7	26.7
1 1/2	90	127	222	98.6	17.5	15.7	40.9
	130	127	222	98.6	17.5	15.7	40.9
2	90	152	254	120.7	19.1	19.1	52.6
	130	152	254	120.7	19.1	19.1	52.6
2 1/2	130	178	276	139.7	22.3	19.1	63
3	130	190	298	152.5	23.9	19.1	78
4	130	229	352	190.5	23.9	19.1	102

Dimensions [mm] - Body valve Continuous ELEMENT Type 2301

Thread port connection

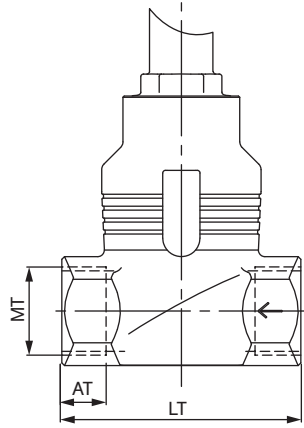

G, RC, NPT (EN ISO 228-1, ISO 7/1 /DIN EN 10226-2, ASME B 1.20.1)

Port size (tube) [mm]	MT G / NPT / RC [inch]	Actuator size [mm]	LT	AT		
				G	NPT	RC
10	3/8	50	65	12	10.3	10.1
		70	65	12	10.3	10.1
15	1/2	50	65	14	13.7	13.2
		70	65	14	13.7	13.2
20	3/4	50	75	16	14	14.5
		70	75	16	14	14.5
25	1	50	90	18	16.8	16.8
		70	90	18	16.8	16.8
		90	90	18	16.8	16.8
32	1 1/4	90	110	20	17.3	19.1
		130	110	20	17.3	19.1
40	1 1/2	90	120	22	17.3	19.1
		130	120	22	17.3	19.1
50	2	90	150	24	17.6	23.4
		130	150	24	17.6	23.4
65	2 1/2	130	185	26	23.7	26.7

Dimensions [mm] - Body valve Continuous ELEMENT Type 2301

Weld ends port connection

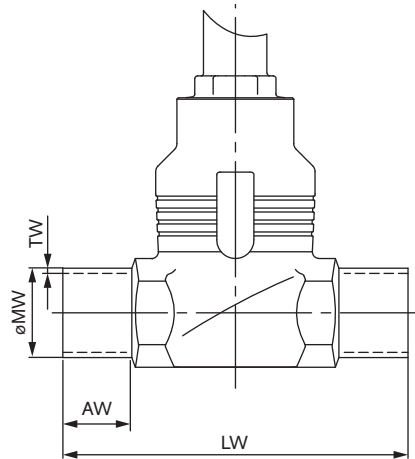

EN ISO 1127 series 1/ISO 4200/DIN 11866 series B, DIN 11850 series 2/DIN 11866 series A/DIN EN 10357 series A

Port size (tube) [mm]	Actuator size [mm]	AW	LW	EN ISO 1127 series 1/ ISO 4200/DIN 11866 series B		DIN 11850 series 2/DIN 11866 series A/ DIN EN 10357 series A	
				ø MW	TW	ø MW	TW
10	50	20	90	17.2	1.6	13	1.5
	70		90	17.2	1.6		
15	50	20	90	21.3	1.6	19	1.5
	70		90	21.3	1.6		
20	50	20	100	26.9	1.6	23	1.5
	70		100	26.9	1.6		
25	50	26	130	33.7	2.0	29	1.5
	70		130	33.7	2.0		
	90		130	33.7	2.0		
32	90	26	140	42.4	2.0	35	1.5
	130		140	42.4	2.0		
40	90	26	150	48.3	2.0	41	1.5
	130		150	48.3	2.0		
50	90	26	175	60.3	2.0	53	1.5
	130		175	60.3	2.0		
65	130	26	210	76.1	2.3	70	2
80	130	26	230	88.9	2.3	85	2
100	130	26	260	114.3	2.6	104	2

BS4825 Part 1, ASME BPE/DIN 11866 series C

Port size (tube) [inch]	Actuator size [mm]	AW	LW	BS 4825 Part 1		ASME BPE/ DIN 11866 series C	
				ø MW	TW	ø MW	TW
1/2	50	20	90	12.7	1.2	12.7	1.65
	70		90	12.7	1.2	12.7	1.65
3/4	50	20	90	19.05	1.2	19.05	1.65
	70		90	19.05	1.2	19.05	1.65
1	50	20	100	25.4	1.6	25.4	1.65
	70		100	25.4	1.6	25.4	1.65
	90		100	25.4	1.6	25.4	1.65
1 1/2	90	26	140	38.1	1.6	38.1	1.65
	130		140	38.1	1.6	38.1	1.65
2	90	26	150	50.8	1.6	50.8	1.65
	130		150	50.8	1.6	50.8	1.65
2 1/2	90	26	175	63.5	1.6	63.5	1.65
	130		175	63.5	1.6	63.5	1.65
3	130	26	210	76.2	1.6	76.2	1.65
4	130	26	260	101.6	2.0	101.6	2

Dimensions [mm] - Body valve Continuous ELEMENT Type 2301

Clamp port connection

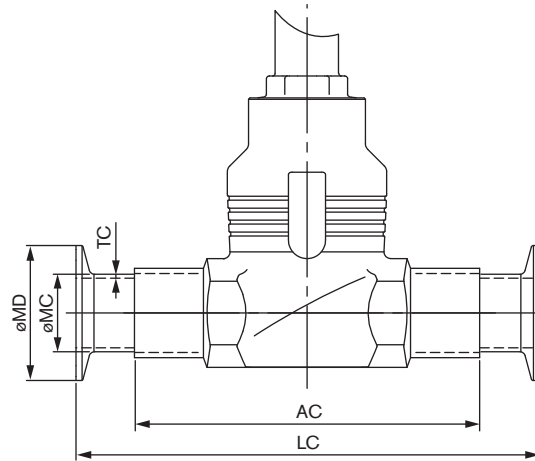

DIN 32676 series A, ASME BPE/DIN 32676 series C or BS4825-3

Port size (tube) [mm]	Actuator size [mm]	AC	LC	Clamp: DIN 32676 series A, Rohr: DIN 11850 series 2/ DIN 11866 series A/ DIN EN 10357 series A			Clamp: ASME BPE/ DIN 32676 series C, Rohr: ASME BPE/ DIN 11866 series C			Clamp: BS4825-3, Rohr: BS4825-1		
				ø MC	ø MD	TC	ø MC	ø MD	TC	ø MC	ø MD	TC
15	70	90	126	19	34.0	1.5	12.7	25.0	1.65	12.7	25.0	1.2
20	70	100	136	23	34.0	1.5	19.05	25.0	1.65	19.05	25.0	1.2
25	90	100	173	29	50.5	1.5	25.4	50.5	1.65	25.4	50.5	1.6
32	90	140	179	35	50.5	1.5	-	-	-	-	-	-
40	130	150	193	41	50.5	1.5	38.1	50.5	1.65	38.1	50.5	1.6
50	130	175	218	53	64.0	1.5	50.8	64.0	1.65	50.8	64.0	1.6

DIN 32676 series B

Port size (tube) [mm]	Actuator size [mm]	AC	LC	Clamp: DIN 32676 series B, Rohr: EN ISO 1127 series 1/ ISO 4200/DIN 11866 series B		
				ø MC	ø MD	TC
15	70	90	146	21.3	50.5	1.6
20	70	100	136	26.9	50.5	1.6
25	90	130	164	33.7	50.5	2.0
32	90	140	178	-	-	-
40	130	150	193	48.3	64.0	2.0
50	130	175	218	60.3	77.5	2.0

Ordering chart Globe Control Valve Type 2301

Flange connection

Flow direction below the seat, Control function A (NC)

Port size (tube)		Seat size		Actuator size ϕ	Kvs-value	Item no. DIN EN 1092-1		Item no. ANSI B 16.5		Item no. JIS 10K	
[mm]	[inch]	[mm]	[inch]	[mm]	[m ³ /h]	Seal/cone		Seal/cone		Seal/cone	
						PTFE/St. St.	St. St./St. St.	PTFE/St. St.	St. St./St. St.	PTFE/St. St.	St. St./St. St.
10	3/8	3	0.12	70	0.1	-	On request	-	-	-	-
		4	0.16	70	0.5	-	215 207	-	-	-	-
		6	0.24	70	1.25	-	215 209	-	-	-	-
		8	0.31	70	2.0	213 985	215 212	-	-	-	-
		10	0.39	70	2.7	213 989	215 215	-	-	-	-
15	1/2	3	0.12	70	0.1	-	233 165	-	On request	-	On request
		4	0.16	70	0.5	-	210 529	-	215 219	-	215 226
		6	0.24	70	1.25	-	215 211	-	215 220	-	215 227
		8	0.31	70	2.1	213 987	215 214	215 198	215 221	215 203	215 228
		10	0.39	70	3.1	213 991	215 217	215 199	215 222	213 913	213 911
		15	0.59	70	4.3	204 932	205 010	204 944	205 021	204 953	205 030
20	3/4	10	0.39	70	3.2	210 530	215 218	215 200	215 223	215 204	215 229
		15	0.59	70	5.2	213 993	214 030	214 009	214 046	213 936	213 933
		20	0.79	70	7.1	204 935	205 012	204 946	205 023	204 955	205 032
25	1	15	0.59	70	5.3	213 994	214 031	214 010	214 047	214 020	214 059
		20	0.79	70	7.2	213 995	214 032	214 011	214 048	213 930	213 914
		25	0.98	70	12.0	204 937	205 014	204 948	205 025	204 957	205 034
		90	12.0	242 054	229 421	464 851	464 367	242 165	242 199		
32	1 1/4	25	0.98	90	9.9	213 997	210 446	-	-	213 939	213 937
		130	13.0	222 634	222 655	-	-	222 643	222 665		
		32	1.3	90	13.4	204 939	205 016	-	-	213 177	213 178
		130	17.8	223 597	223 598	-	-	222 645	222 667		
40	1 1/2	32	1.3	90	14.4	213 999	214 035	215 201	215 224	213 932	213 931
		130	20.2	222 636	222 657	463 905	463 913	222 647	222 668		
		40	1.6	90	17.5	204 941	205 018	204 950	205 027	204 959	205 037
		130	23.8	219 791	222 659	463 907	463 915	222 649	222 670		
50	2	40	1.6	90	18.0	214 001	214 037	214 013	214 050	213 941	213 940
		130	24.6	222 638	222 660	463 908	463 916	222 650	222 671		
		50	2.0	90	28.0	204 942	205 019	204 951	205 028	204 960	205 038
		130	37.0	214 003	214 039	214 015	214 052	214 023	214 062		
65	2 1/2	50	2.0	130	45.0	214 005	214 040	239 537	239 573	214 024	214 063
		65	2.6	130	65.0	217 772	219 618	239 535	239 572	219 617	219 620
80	3	65	2.6	130	73.0	239 545	239 581	239 546	239 582	239 547	239 584
		80	3.2	130	100.0	239 540	239 576	239 541	239 577	239 542	239 578
100	4	80	3.2	130	110.0	239 561	239 597	239 562	239 598	239 563	239 599
		100	3.9	130	140.0	239 556	239 592	239 557	239 593	239 558	239 594

 Further versions on request

Control function
B (normally open: NO)

Process connection
Further port connections

Approvals
FDA, ATEX, DVGW

Ordering chart Globe Control Valve Type 2301, continued

Thread connection

Flow direction below the seat, Control function A (NC)

Port size (tube)		Seat size		Actuator size ϕ	Kvs-value	Item no. G (EN ISO 228-1) Seal/cone		Item no. NPT (ISO 7/1 / DIN EN 10226-2) Seal/cone		Item no. RC (ASME B 1.20.1) Seal/cone	
[mm]	[inch]	[mm]	[inch]	[mm]	[m ³ /h]	PTFE/St. St.	St. St./St. St.	PTFE/St. St.	St. St./St. St.	PTFE/St. St.	St. St./St. St.
10	3/8	3	0.12	70	0.1	-	284 168	-	On request	-	On request
		4	0.16	70	0.5	-	215 238	-	220 447	-	220 513
		6	0.24	70	1.25	-	215 240	-	220 450	-	220 516
		8	0.31	70	2.0	215 233	215 242	220 418	220 453	220 484	220 519
15	1/2	10	0.39	70	2.7	215 235	215 245	220 421	220 457	220 487	220 523
		3	0.12	70	0.1	-	227 784	-	466 159	-	233 369
		4	0.16	70	0.5	-	208 843	-	220 884	-	220 891
		6	0.24	70	1.25	-	215 241	-	220 452	-	220 518
20	3/4	8	0.31	70	2.1	212 964	215 243	220 881	220 455	220 888	220 521
		10	0.39	70	3.1	215 236	215 246	220 423	220 459	220 489	220 525
		15	0.59	70	4.3	206 432	213 955	220 882	220 886	220 889	220 894
		10	0.39	70	3.2	215 237	215 247	220 425	220 461	220 491	220 527
25	1	15	0.59	70	5.3	206 588	210 460	220 428	220 464	220 494	220 530
		20	0.79	70	7.2	206 586	210 721	220 431	220 467	220 497	220 533
		25	0.98	70	12.0	189 145	210 485	220 434	220 470	220 500	220 536
		90	12.0	242 203	242 207	464 864	464 867	242 257	242 380		
32	1 1/4	90	9.9	214 070	210 407	220 435	220 471	220 501	220 537		
		130	13.0	222 677	222 687	463 921	463 931	222 740	222 777		
		32	1.3	90	13.4	210 097	210 458	220 437	220 473	220 503	220 539
		130	17.8	223 599	223 600	463 956	463 957	223 605	223 606		
40	1 1/2	90	14.4	214 072	214 084	220 438	220 474	220 504	220 540		
		130	20.2	222 679	222 689	463 923	463 933	222 742	222 763		
		40	1.6	90	17.5	210 098	207 800	220 440	220 476	220 506	220 542
		130	23.8	222 681	222 691	463 925	463 935	222 767	222 765		
50	2	90	18.0	214 074	214 086	220 441	220 477	220 507	220 543		
		130	24.6	222 682	222 692	463 926	463 936	222 768	222 766		
		50	2.0	90	28.0	210 099	203 693	220 443	220 479	220 509	220 545
		130	37.0	214 076	214 088	220 444	220 480	220 510	220 546		
65	2 1/2	50	2.0	130	45.0	214 077	214 089	239 536	239 620	220 511	220 547
		65	2.6	130	65.0	219 621	219 622	239 534	239 571	220 512	220 548

 Further versions on request

Control function
B (normally open: NO)

Process connection
Further port connections

Approvals
FDA, ATEX, DVGW

Ordering chart Globe Control Valve Type 2301, continued

Weld ends connection

Flow direction below the seat, Control function A (NC)

Port size (tube)		Seat size		Actuator size \varnothing	Kvs-value	Item no. EN ISO 1127 series 1 / ISO 4200 / DIN 11866 Series B Seal/cone		Item no. DIN 11850 Series 2 / DIN 11866 Series A / DIN EN 10357 Series A Seal/cone		Item no. ASME BPE / DIN 11866 Series C Seal/cone	
[mm]	[inch]	[mm]	[inch]	[mm]	[m ³ /h]	PTFE/St. St.	St. St./St. St.	PTFE/St. St.	St. St./St. St.	PTFE/St. St.	St. St./St. St.
						Connection MW x TW		Connection MW x TW		Connection MW x TW	
10	3/8					17.2 x 1.6		13.0 x 1.5		-	
		3	0.12	70	0.1	-	On request	-	250 658	-	-
		4	0.16	70	0.5	-	On request	-	284 171	-	-
		6	0.24	70	1.25	-	On request	-	284 177	-	-
		8	0.31	70	2.0	On request	On request	On request	284 179	-	-
		10	0.39	70	2.7	On request	On request	257 412	208 553	-	-
15	1/2					21.3 x 1.6		19.0 x 1.5		12.7 x 1.65	
		3	0.12	70	0.1	-	259 240	-	225 130	-	466 160
		4	0.16	70	0.5	-	215 254	-	215 257	-	464905
		6	0.24	70	1.25	-	215 255	-	215 258	-	464907
		8	0.31	70	2.1	212 392	215 872	215 250	215 911	464 878	464909
		10	0.39	70	3.1	212 393	215 873	215 251	215 913	464 882	222997
20	3/4					26.9 x 1.6		23.0 x 1.5		19.05 x 1.65	
		15	0.59	70	5.2	214 094	214 132	214 113	208 555	464 455	211017
		20	0.79	70	7.1	214 096	210 696	211 937	211 953	-	-
25	1					33.7 x 2.0		29.0 x 1.5		25.4 x 1.65	
		20	0.79	70	7.2	214 097	214 135	214 116	214 154	464 891	464920
32	1 1/4					42.4 x 2.0		35.0 x 1.5		-	
		25	0.98	90	9.9	214 101	214 139	214 119	214 156	-	-
40	1 1/2					48.3 x 2.0		41.0 x 1.5		38.1 x 1.65	
		32	1.3	90	14.4	214 104	214 142	214 121	213 487	464 898	464927
				130	20.2	222 700	222 721	222 711	222 732	464 899	464928
		40	1.6	90	17.5	209 440	214 144	211 967	209 110	-	-
130	23.8			222 702	222 723	222 713	222 734	-	-		
50	2					60.3 x 2.0		53.0 x 1.5		50.8 x 1.65	
		40	1.6	90	18.0	210 756	213 561	214 123	213 411	464 902	464931
				130	24.6	222 703	222 724	222 714	222 735	464 903	464932
		50	2.0	90	28.0	214 107	214 146	211 968	209 185	-	-
130	37.0			214 108	214 147	214 125	214 159	-	-		
65	2 1/2					76.1 x 2.3		70.0 x 2.0		-	
		65	2.6	130	65.0	219 623	219 626	219 625	219 628	-	-
80	3					88.9 x 2.3		85.0 x 2.0		-	
		80	3.2	130	100.0	239 543	239 579	239 544	239 580	-	-
100	4					114.3 x 2.6		104.0 x 2.0		-	
		100	3.9	130	140.0	239 559	239 595	239 560	239 596	-	-

 Further versions on request

 **Control function**
B (normally open: NO)

 **Process connection**
Further port connections

 **Approvals**
FDA, ATEX, DVGW

Ordering chart Globe Control Valve Type 2301, continued

Clamp connection

Flow direction below the seat, Control function A (NC)

Port size (tube)		Seat size		Actuator size \varnothing	Kvs-value	Item no. DIN 32676 series A		Item no. DIN 32676 series B	
						Seal/cone		Seal/cone	
[mm]	[inch]	[mm]	[inch]	[mm]	[m ³ /h]	PTFE/St. St.	St. St./St. St.	PTFE/St. St.	St. St./St. St.
						Connection MC x TC, TC		Connection MC x TC, TC	
15	1/2	15	0.59	70	4.3	19 x 1.5, 34		21.3 x 1.6, 50.5	
						222 593	282 208	273 974	282 213
20	3/4	20	0.79	70	7.1	23 x 1.5, 34		26.9 x 1.6, 50.5	
						225 647	282 209	209 438	282 214
25	1	25	0.98	90	12.0	29 x 1.5, 50.5		33.7 x 2.0, 50.5	
						222 594	282 210	241 115	282 215
32	1 1/4	32	1.3	90	13.4	35 x 1.5, 50.5		-	
						240 415	282 211	-	-
40	1 1/2	40	1.6	130	23.8	41 x 1.5, 50.5		48.3 x 2.0, 64.0	
						240 351	282 212	209 880	284 181
50	2	50	2.0	130	37.0	53 x 1.5, 64		60.3 x 2.0, 77.5	
						282 258	282 259	282 261	282 263

 Further versions on request

 **Control function**
B (normally open: NO)

 **Process connection**
Further port connections

 **Approvals**
FDA, ATEX, DVGW

Valve system Continuous ELEMENT– request for quotation

Note
You can fill out the fields directly in the PDF file before printing out the form.

▶ Please fill out and send to your nearest Bürkert office* with your inquiry or order

Company:	Contact person:
Customer no.:	Department:
Address:	Tel./Fax.:
Postcode/town:	E-Mail:

= mandatory fields to fill out

Quantity:

Required delivery date:

Operating data

Pipe line DN PN

Pipe Material

Process medium

Type of medium Liquid Steam Gas

	min.	standard	max.	Unit
<input type="checkbox"/> Flow rate (Q, Q _N , W) ¹⁾	<input type="text"/>	<input type="text"/>	<input type="text"/>	<input type="text"/>
<input type="checkbox"/> Temperature at valve inlet T1	<input type="text"/>	<input type="text"/>	<input type="text"/>	<input type="text"/>
<input type="checkbox"/> Absolute pressure at valve inlet P1	<input type="text"/>	<input type="text"/>	<input type="text"/>	<input type="text"/>
<input type="checkbox"/> Absolute pressure at valve outlet P2	<input type="text"/>	<input type="text"/>	<input type="text"/>	<input type="text"/>
Steam Pressure P _v	<input type="text"/>	<input type="text"/>	<input type="text"/>	<input type="text"/>
Kinematic viscosity (ν)	<input type="text"/>	mm ² /s or cSt		
Dynamic viscosity (η)	<input type="text"/>	mPa.s or cP		
Standard density	<input type="text"/>	Kg/m ³		
Max. sound level accepted	<input type="text"/>	dB (A)		

¹⁾ standard unit:
Liquid Q = m³/h;
Steam W = kg/h;
Gas Q_N = Nm³/h

Valves features

Cone seal material PTFE/Stainless steel Stainless steel/Stainless steel PEEK/Stainless steel

Nominal pressure PN

Seat size (orifice) DN

Type of connection Flanged Threaded Welded Clamp

Standard connection ISO DIN Other

Control function NC¹⁾ NO¹⁾

¹⁾ NC: normally closed by spring action; NO: normally open by spring action:

Please specify item no. (if known):

Comments



continued on next page →

Valve system Continuous ELEMENT– request for quotation, *continued*

Control unit features

Click on the orange box „More info.“ below... you will come to our website for the resp. product where you can download the data sheet.

For actuator sizes $\varnothing 70/\varnothing 90/\varnothing 130$ mm

<input type="checkbox"/> Process Controller TopControl Type 8693 More info.  <ul style="list-style-type: none"> ▪ Intelligent digital positioners and process controllers with integrated PID controller for accurate process control ▪ Lighted graphic display with membrane keypad ▪ Tune function for automatic start-up ▪ Field bus communication ▪ Diagnostic functions 	<input type="checkbox"/> Positioner TopControl Type 8692 More info.  <ul style="list-style-type: none"> ▪ Digital positioner without sensor input ▪ Lighted graphic display with membrane keypad ▪ Tune function for automatic start-up ▪ Field bus communication ▪ Diagnostic functions
<p>Pneumatic function</p> <input type="checkbox"/> Single-acting <input type="checkbox"/> Double-acting	
<p>Communication</p> <input type="checkbox"/> Profibus <input type="checkbox"/> DeviceNet <input type="checkbox"/> None	
<p>Diagnostic function^{*)}</p> <input type="checkbox"/> Yes <input type="checkbox"/> No	
<p>Analogue feedback</p> <input type="checkbox"/> 0/4...20 mA <input type="checkbox"/> 0/4...20 mA + 2 binary outputs	
<p>Electrical connection</p> <input type="checkbox"/> Cable gland <input type="checkbox"/> Multipol connection <input type="checkbox"/> None	
<p>Proximity switches (optional)</p> <input type="checkbox"/> Yes (Request an end position) <input type="checkbox"/> No	
<p><small>*) In combination with digital outputs</small></p>	

For actuator sizes $\varnothing 70/\varnothing 90/\varnothing 130$ mm

 Positioner TopControl Type 8694 More info.

- Status LED and DIP switches
- Tune-function for automatic start-up
- Positioning system for single-acting actuators
- With AS-Interface fieldbus

Pneumatic function

 Single-acting

For actuator size $\varnothing 50$ mm

 Positioner TopControl Type 8696 More info.

- Status LED and DIP switches
- Tune-function for automatic start-up
- Positioning system for single-acting actuators
- With AS-Interface fieldbus

Pneumatic function

 Single-acting



continued on next page →

Valve system Continuous ELEMENT– request for quotation, continued

Control unit features

Click on the orange box „More info.“ below... you will come to our website for the resp. product where you can download the data sheet.



For actuator sizes $\varnothing 70/\varnothing 90/\varnothing 130$ mm

<input type="checkbox"/> Process Controller SideControl Type 8793 with remote sensor Type 8798 More info. More info.  <ul style="list-style-type: none"> ▪ Intelligent digital positioners and process controllers with integrated PID controller ▪ Lighted graphic display with membrane keypad ▪ Tune-function for automatic start-up, linearization and optimization of process characteristics ▪ Field bus communication ▪ Diagnostic functions 	<input type="checkbox"/> Positioner SideControl Type 8792 with remote sensor Type 8798 More info. More info.  <ul style="list-style-type: none"> ▪ Digital positioner without sensor input ▪ Lighted graphic display with membrane keypad ▪ Tune function for automatic start-up ▪ Field bus communication ▪ Diagnostic functions
--	--

Pneumatic function <input type="checkbox"/> Single-acting (actuator size $\varnothing 70/90$) <input type="checkbox"/> Single and Double-acting (actuator size $\varnothing 130$)	Analogue feedback <input type="checkbox"/> 0/4...20 mA <input type="checkbox"/> 0/4...20 mA + 2 binary outputs <input type="checkbox"/> 0...5/10 V <input type="checkbox"/> 0...5/10 V + 2 binary outputs	Approvals <input type="checkbox"/> ATEX Cat. 3GD <input type="checkbox"/> None
Communication <input type="checkbox"/> Profibus <input type="checkbox"/> DeviceNet <input type="checkbox"/> None	Electrical connection <input type="checkbox"/> Cable gland (without Bus) <input type="checkbox"/> Multipol connection	
Diagnostic function^{*)} <input type="checkbox"/> Yes <input type="checkbox"/> No		

*) In combination with digital outputs

For actuator sizes $\varnothing 70/\varnothing 90/\varnothing 130$ mm

<input type="checkbox"/> Positioner SideControl Basic Type 8791 with remote sensor Type 8798 More info. More info.  <ul style="list-style-type: none"> ▪ „simple positioner“ ▪ Universal positioning system for single and double acting actuators ▪ Tune function for automatic start-up ▪ Feldbuskommunikation 	<input type="checkbox"/> Positioner SideControl Basic IP20 Type 8791 with remote sensor Type 8798 More info. More info.  <ul style="list-style-type: none"> ▪ „simple positioner“ ▪ Universal positioning system for single and double acting actuators ▪ Tune function for automatic start-up
--	---

Pneumatic function <input type="checkbox"/> Single-acting (actuator size $\varnothing 70/90$) <input type="checkbox"/> Single and Double-acting (actuator size $\varnothing 130$)	Analogue feedback <input type="checkbox"/> 0/4...20 mA <input type="checkbox"/> No	Approvals <input type="checkbox"/> ATEX Cat. 3GD (not by Basic IP20) <input type="checkbox"/> None
Communication AS-Interface (not by Basic IP20) <input type="checkbox"/> Analogue-Profile S-7.3.4 (Only setpoint) <input type="checkbox"/> Analogue-Profile S-7A.5 (Only setpoint and Feedback) <input type="checkbox"/> None	Electrical connection <input type="checkbox"/> Cable gland (without Bus) <input type="checkbox"/> Multipol connection	

In case of special application conditions,
please consult for advice.

Subject to alteration.
© Christian Bürkert GmbH & Co. KG

1603/8_EU-en_00895107