





2/2 or 3/2 way Flipper-Solenoid Valve with separating diaphragm

- Only 4.5 mm wide
- Medium isolation, for aggressive fluids
- Direct-acting
- Vacuum up to 7 bar
- Short response times



Product variants described in the data sheet may differ from the product presentation and description.

Can be combined with

	Type 2504 ▶ Cable Plug for Bürkert Solenoid Valve Type 6650
	Type 8763 ▶ Pressure controller for precise time-pressure dosing

Type description

With a width of only 4.5mm, Type 6650 sets a new standard in medium isolation miniature solenoid valves. The optimized design enables reproducible and precise dosing, good rinsing capability and is suitable for the application of aggressive chemicals owing to the high quality of the materials used. With the two nominal sizes of 0.4 and 0.8mm, as well as the selection between 2/2-way and 3/2-way function, it is ideal for applications where the highest fluid performances are required in the smallest space. Type 6650 opens up new possibilities, owing to the 4.5mm station width, in particular in connection with dosing in 384-well microtiterplates. Based on the well-known flipper principle (Type 0330) it is tied to the success history of the legendary Type 127.

Table of contents

1. General Technical Data	3
2. Circuit functions	3
3. Materials	4
3.1. Chemical Resistance Chart – Bürkert resistApp.....	4
4. Dimensions	4
4.1. Valve	4
4.2. Cable plug type 2504 with integrated booster and power reduction electronics.....	5
4.3. Single manifolds made of PEEK for Bürkert sub-base interface 3 way	5
5. Ordering information	5
5.1. Bürkert eShop – Easy ordering and quick delivery.....	5
5.2. Bürkert product filter.....	6
5.3. Ordering chart.....	6
5.4. Ordering chart accessories.....	7

1. General Technical Data

Product properties	
Dimensions	Detailed information can be found in chapter “4. Dimensions” on page 4.
Material	
Seal	FFKM (Simriz)
Body	PEEK
Internal volume	
Fluid chamber	Ca. 30 µl
2/2 way	Ca. 37 µl
3/2 way	Ca. 42 µl
Nominal diameter	DN 0.4 and DN 0.8
Performance data	
Switching times	<5 ms (acc. to ISO 12238)
Electrical data	
Operating voltage	24 V (12 V on request)
Voltage tolerance	± 10 %
Duty cycle	100 % continuous operation only with external power reduction ^{1.)}
Switching frequency	80 Hz (for mechanical limit observe maximum temperature) ^{1.)} 15 Hz (continuous only with external power reduction ^{1.)}
Nominal power	5.7 W inrush power 0.7 W holding power with power reduction. For 100 % duty cycle the power must be reduced externally. ^{1.)} For details on power electronics, see chapter “4.2. Cable plug type 2504 with integrated booster and power reduction electronics” on page 5.
Medium data	
Medium temperature	+ 15 °C...+ 50 °C
Operating medium	Resistant to neutral and aggressive fluids and gases, see chapter “3.1. Chemical Resistance Chart – Bürkert resistApp” on page 4.
Process/Port connection & communication	
Port connection	Flange
Electrical connection	Cable plug Type 2504 ▶
Environment and installation	
Ambient temperature	+ 10 to + 50 °C
Installation position	As required, with side by side connection standard polarity is adhered to
Degree of protection	IP65

1.) For further information, please refer to operating instructions [Type 6650](#) ▶.

2. Circuit functions

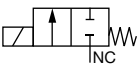
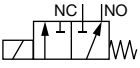
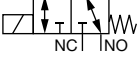
Circuit functions	Description
	Type: A, solenoid valve 2/2 way Direct-acting Normally closed
	Type: F, distribution solenoid valve 3/2 way Direct-acting
	Type: T, solenoid valve 3/2 way Direct-acting Flow direction optional Universal

3. Materials

3.1. Chemical Resistance Chart – Bürkert resistApp

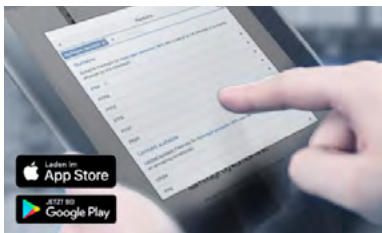

Bürkert resistApp – Chemical Resistance Chart

You want to ensure the reliability and durability of the materials in your individual application case? Verify your combination of media and materials on our website or in our resistApp.

[Start Chemical Resistance Check](#)

4. Dimensions

4.1. Valve

Note:
Dimensions in mm

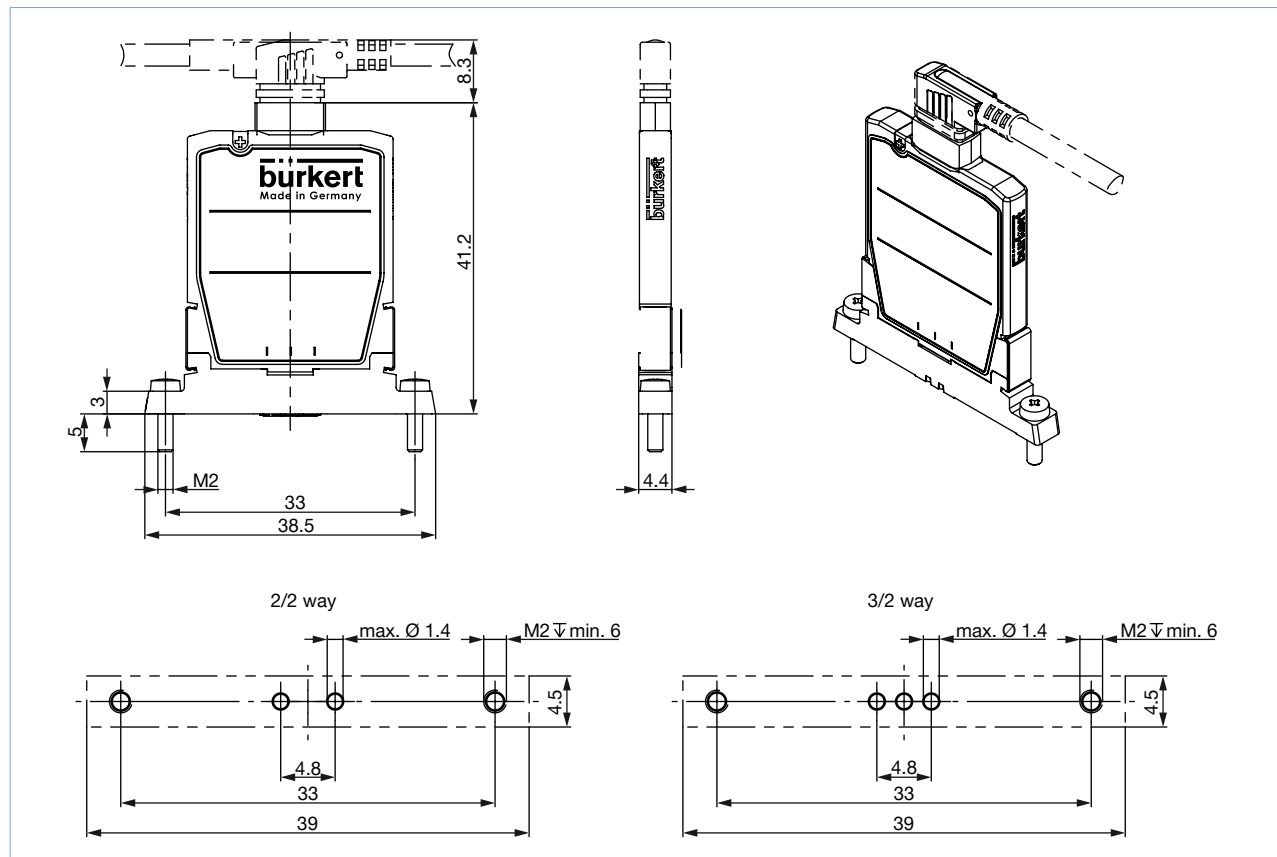

DTS 1000105258 EN Version: P Status: RL (released | freigegeben | validé) printed: 07.05.2020

4.2. Cable plug type 2504 with integrated booster and power reduction electronics

Note:
Dimensions in mm

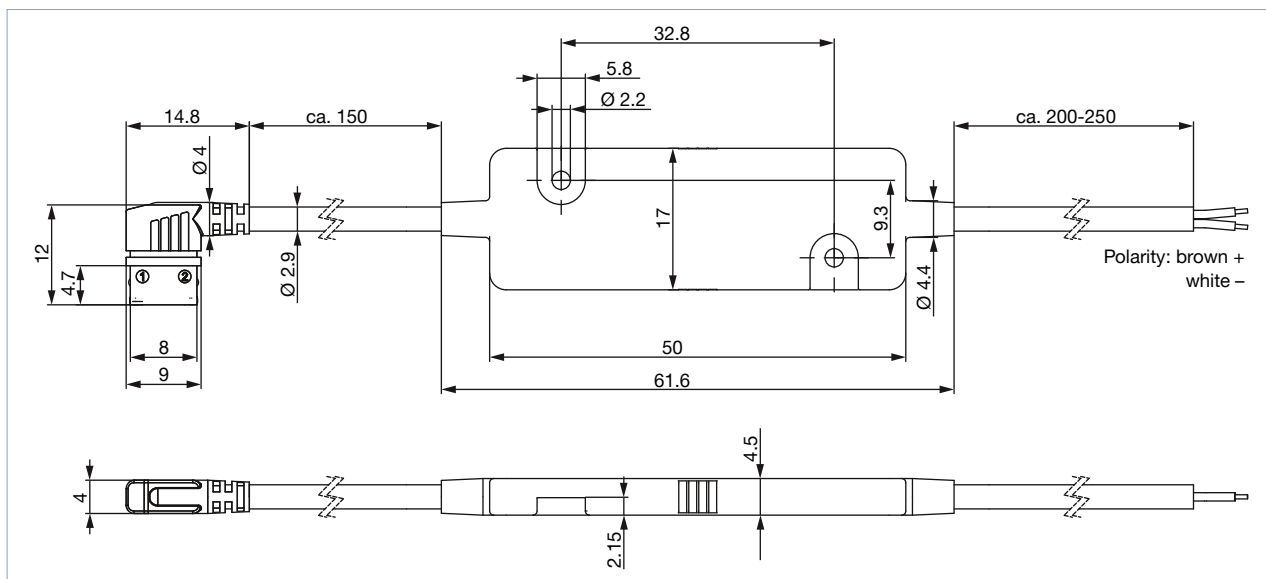

4.3. Single manifolds made of PEEK for Bürkert sub-base interface 3 way

Note:
Dimensions in mm

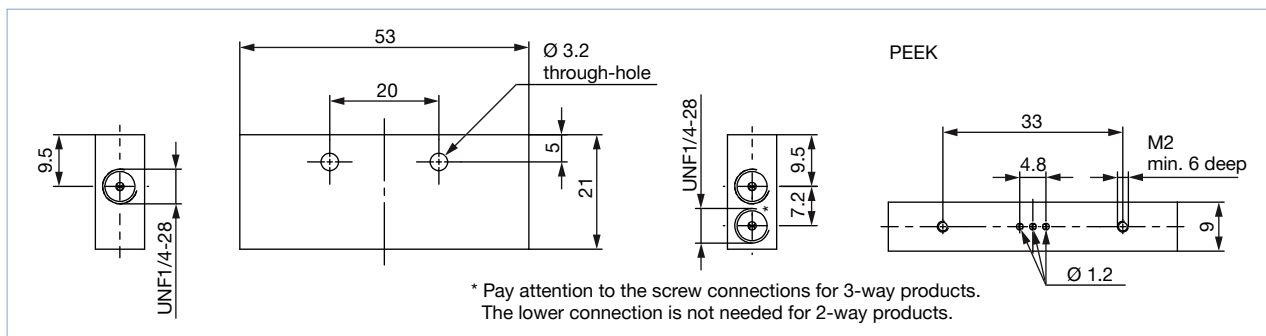

Description	Article no.
Single manifold material Peek	670181

5. Ordering information

5.1. Bürkert eShop – Easy ordering and quick delivery



Bürkert eShop – Easy ordering and fast delivery

You want to find your desired Bürkert product or spare part quickly and order directly? Our online shop is available for you 24/7. Sign up and enjoy all the benefits.

[Order online now](#)

5.2. Bürkert product filter



Bürkert product filter – Get quickly to the right product



You want to select products comfortably based on your technical requirements? Use the Bürkert product filter and find suitable articles for your application quickly and easily.

[Try out our product filter](#)

5.3. Ordering chart

Note:

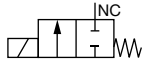
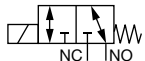
Mounting screws: Stainless steel, 2x M2 x 8 (included)

Circuit function	Orifice	K_v value water	Pressure range	Max. pressure difference	Voltage	Nominal power (Inrush-/nominal holding power)	Article no.
	[mm]	[m ³ /h] ^{1.)}	[bar] ^{2.)}	[bar]	[V]	[W]	
A, solenoid valve 2/2 way Direct-acting Normally closed 	0.4 ^{3.)}	0.004	Vac.-7	7	24	5.7/0.7	182284
	0.8 ^{4.)}	0.010	Vac.-3	3	24	5.7/0.7	226664
T, solenoid valve 3/2 way Direct-acting Flow direction optional Universal 	0.8	0.010	Vac.-1	1	24	5.7/0.7	189292
F, distribution solenoid valve 3/2 way Direct-acting 	0.8	0.010	Vac.-3	3	24	5.7/0.7	227020

1.) Measured at +20 °C, 1 bar pressure at valve inlet and free outlet.

2.) Measured as overpressure to the atmospheric pressure

3.) With orifice 0.4 mm flow permitted in both directions.

4.) With orifice 0.8 mm flow direction according to label.



Further versions on request



Voltage

12 V on request (external power reduction necessary, not possible with Article no. 670178)

5.4. Ordering chart accessories

Accessories	Description	Article no.
	Cable plug type 2504 with integrated hit and hold electronic, 24 V DC, 500 mm long, Power reduction to 0.7 W after 5 ms	670178
	Cable plug type 2504, single cable, 500 mm long ^{1.)}	670164
	Cable plug type 2504, single cable, 5000 mm long ^{1.)}	680840

1.) The valve must be operated with external power reduction. After 5 ms the voltage is reduced to 0.35x nominal voltage in hold mode or switched to a PWM signal (20 kHz, duty cycle 33 %). If the available integrated electronics are not used, the power must be reduced accordingly on the control side. If no power reduction is used, the permissible duty cycle is reduced, see operating instructions **Type 6650** ▶.

DTS 1000105258 EN Version: P Status: RL (released | freigegeben | validé) printed: 07.05.2020