

Paddle wheel flowmeter with optical principle for On/Off control



Type 8039 can be combined with...



Type 8801-YE

On/Off System,
angle-seat valve



Type 8611

Universal Controller
eControl

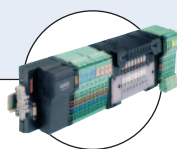

Type 8644-P AirLINE

Valve island with
electronic I/O

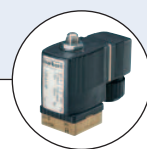

Type 6014

Solenoid valve

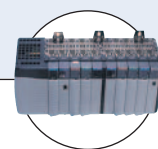

PLC

This flowmeter with an extra-large display is specially designed to switch a valve and to establish a monitoring system or an On/Off control loop.

Switching points can be programmed with the 3-key keypad under the display and the connection to the process in the piping is done with standard fittings.

The version with a frequency output makes it possible to transmit the paddle wheel rotation speed (2 pulses/paddle wheel rotation) directly to a PLC.

General data

Compatibility	With fittings S039
Materials	Housing, cover Front panel folio Cable plug Wetted parts materials Fitting / Holder Paddle wheel Axis and bearing / Seal
Electrical connection	Cable plug: EN 175301-803 (provided) Free positionable male fixed connector M12-5 pin for female 5-pin M12 cable plug (not provided)
Connection cable	0.14 up to 0.5 mm ² cross-section; max. 100 m length

Complete device data (fitting + electronic module)

Pipe diameter	DN06 to DN50
Measuring range	0.3 to 10 m/s
Sensor element	Paddle wheel without magnet
Medium temperature	-15 to 100°C (5 to 212°F)
Fluid pressure max.	PN10 (145.1 PSI) at 20°C (at 68°F)
Viscosity / Pollution	300 cSt. max. / max. 1% (size of particles 0.5 mm max.)
Measurement error	Teach-In Standard K-factor
Linearity	±0.5% of FS.*
Repeatability	±0.4% of Reading ¹⁾

* FS. = Full scale (10 m/s)

1) Under reference conditions i.e. measuring fluid = water, ambient and water temperature = 20°C, applying the minimum inlet and outlet pipe straights, matched inside pipe dimensions.

Electrical data	
Operating voltage (V+)	12 - 30 V DC, filtered and regulated
Current consumption	≤ 80 mA (without load)
Reversed polarity of DC	Protected
Threshold programming mode	window or hysteresis
Output	
Transistor for threshold (configurable)	Transistor NPN and/or PNP, open collector, 5 - 30 V DC, max. 700 mA, protect against short circuit.
Relay (configurable)	3A/250 V AC or 3A/30 V DC
Frequency	Transistor NPN, open collector, 5 - 30 V DC, max. 700 mA
Environment	
Ambient temperature	0 to +60°C (operating and storage)
Relative humidity	≤ 80%, without condensation
Standards, directives and approvals	
Protection class	IP65 with connector plugged-in and tightened
Standard and directives	
EMC	EN 50081-1, 50082-2
Low voltage	EN 61010-1
Pressure	Complying with article 3 of §3 from 97/23/CE directive.*
Vibration	EN 60068-2-6
Shock	EN 60068-2-27

* For the 97/23/CE pressure directive, the device can only be used under following conditions (depend on max. pressure, pipe diameter and fluid).

Type of fluid	Conditions
Fluid group 1, §1.3.a	DN ≤ 25 only
Fluid group 2, §1.3.a	PN*DN ≤ 1000
Fluid group 1, §1.3.b	PN*DN ≤ 2000
Fluid group 2, §1.3.b	DN ≤ 200

Pressure/temperature diagram

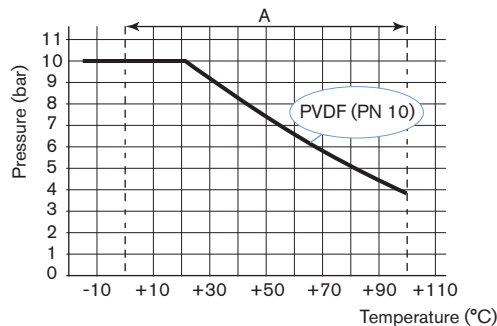

A: Application range for complete device (fitting + electronic module)

Design and principle of operation

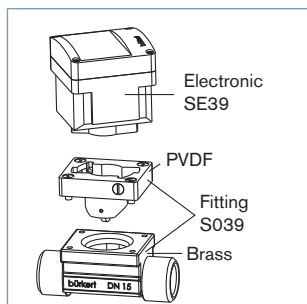

The flowmeter 8039 is built up with an electronic module and a measurement paddle wheel associated to a fitting. This connection is made by means of screws.

When liquid flows through the pipe, the paddle wheel is set in rotation, generating a measuring signal (pulses) which frequency is proportional to the flow velocity. A conversion coefficient (K factor, available in the instruction manual of the fitting), specific to each pipe (size and material) enables the conversion of this frequency into flow rate.

The output signal is provided via cable plug according to EN 175301-803 and/or a free positionable male M12-5 pin fixed connector.

Display and operation

The device can be calibrated by means of the K-factor, or via the TEACH-IN function. Customized adjustments, such as engineering units, output, filter, bargraph are carried out on site.

The operation is specified according to three levels:

- **Indication in operating mode / Display**
 - measured flow
 - high threshold value
 - low threshold value
- **Parameter definition**
 - engineering units (International measuring units)
 - K-factor / TEACH-IN function
 - selection of switching mode¹⁾ (window, hysteresis)
 - selection of threshold value¹⁾
 - filter
 - 10-segment bargraph (select min. and max. value)
- **Test**
 - switching threshold test with flow simulation (dry-run test operation)

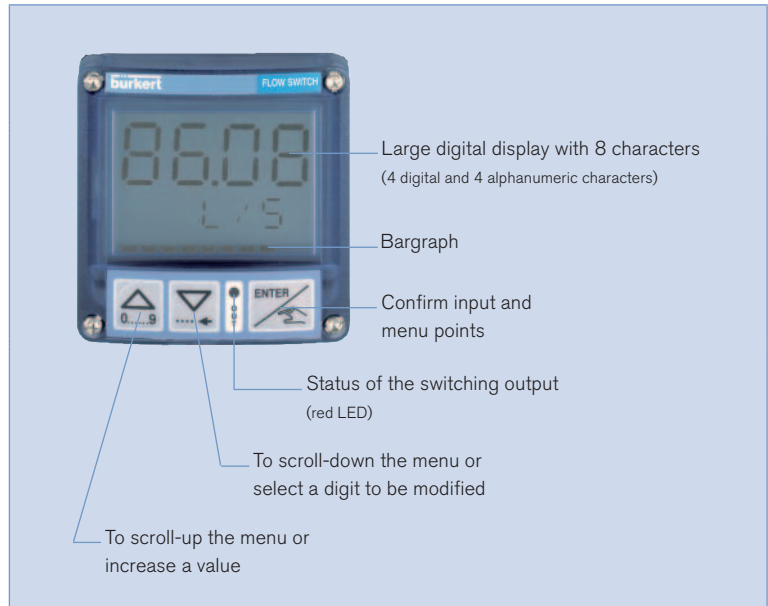

¹⁾ 8039 with standard On/Off output

- 2 switching modes for the output, either hysteresis or window, inverted or not
- Parameterizable delay before switching
- Possible outputs depending on the version: relay, transistor NPN, transistor PNP, frequency

Hysteresis operation

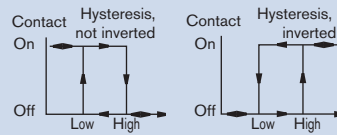

Window operation

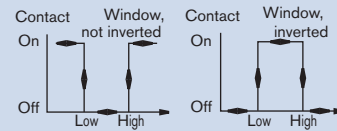

Installation

Minimum straight upstream and downstream distances must be observed. According to the pipe design, necessary distances can be bigger or use a flow conditioner to obtain the best accuracy. For more information, please refer to EN ISO 5167-1.

EN ISO 5167-1 prescribes the straight inlet and outlet distances that must be complied with when installing fittings in pipe lines in order to achieve calm flow conditions. The most important layouts that could lead to turbulence in the flow are shown below, together with the associated prescribed minimum inlet and outlet distances. These ensure calm, problem-free measurement conditions at the measurement point.

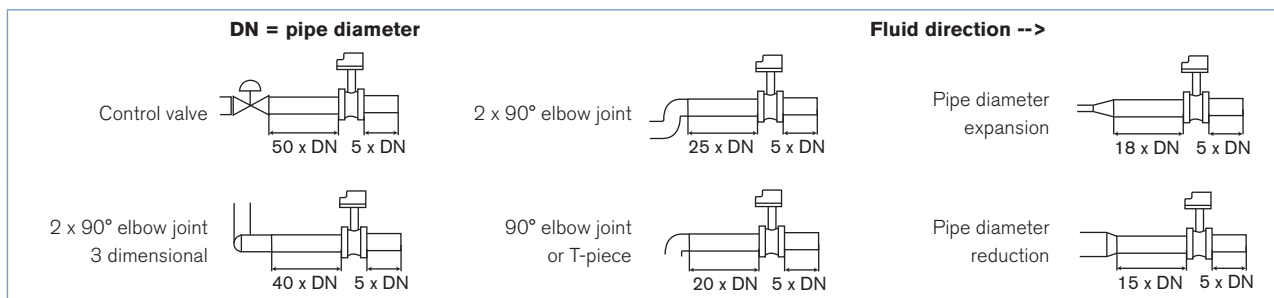

Installation (continued)

The device can be installed into either horizontal or vertical pipes.

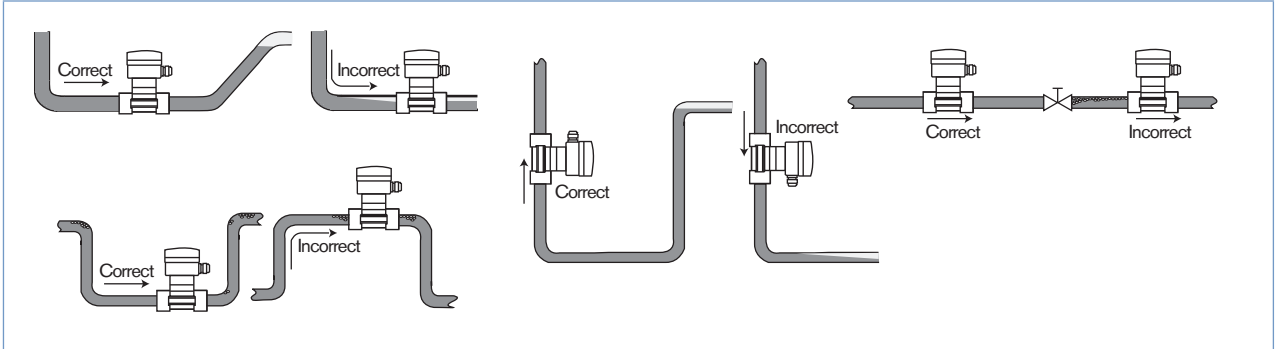

Pressure and temperature ratings must be respected according to the selected fitting material.
 The suitable pipe size is selected using the diagram Flow/Velocity/DN.
 The measuring device is not designed for gas flow measurement.

Diagram Flow/Velocity/DN

Example:

- Flow: 10 m³/h
 - Ideal flow velocity: 2...3 m/s
- For these specifications, the diagram indicates a pipe size of DN40

Flow rate of fluid

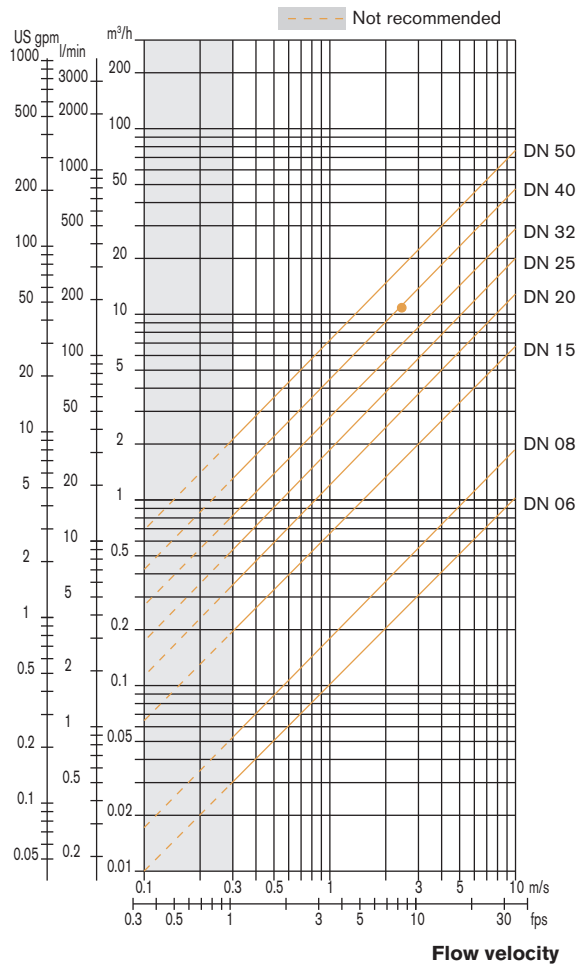

Dimensions 8039

8039 with internal thread connection

G, NPT

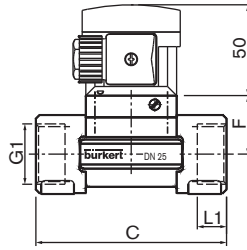

DN [mm]	F [mm]	C [mm]	G1			L1 [mm]
			[inch]	[inch]	[mm]	
15	34.5	84.0	G 1/2	NPT 1/2		16.0
20	32.0	94.0	G 3/4	NPT 3/4		17.0
25	32.2	104.0	G 1	NPT 1		23.5
32	35.8	119.0	G 1 1/4	NPT 1 1/4		23.5
40	39.6	129.0	G 1 1/2	NPT 1 1/2		23.5
50	45.7	150.0	G 2	NPT 2		27.5

8039 with external thread connection

G, NPT or metric

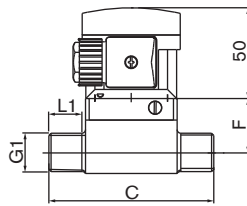

DN [mm]	F [mm]	C [mm]	G1			L1 [mm]
			[inch]	[inch]	[mm]	
06	29.7	90.0	G 1/4	G 1/2		14.0
08	29.7	90.0	G 1/2	NPT 1/2	M16x1.5	14.0

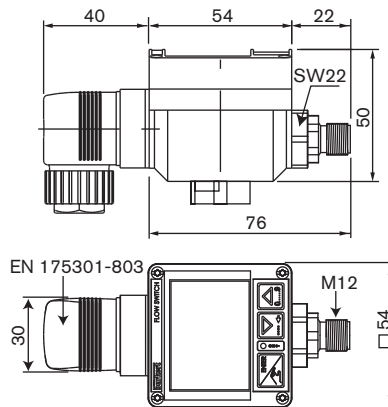

Ordering chart for flowmeter 8039

The flowmeter Type 8039 is built-up of an electronic module Type SE39 + an INLINE fitting Type S039.

Note: Please order the two required units separately. If a cable connector (M12) is needed please order that too

Electronic module Type SE39 - for fitting Type S039

Voltage supply	Output	Electrical connection	Item n.o.
12 - 30 V DC	NPN	Cable plug EN 175301-803	440 378
	PNP	Cable plug EN 175301-803	440 379
	NPN and PNP	Free positionable male fixed connector 5-pin M12	440 377
	Relay	Free positionable male fixed connector 5-pin M12 and cable plug EN 175301-803	440 382
	Relay and frequency	Free positionable male fixed connector 5-pin M12 and cable plug EN 175301-803	447 806

Ordering chart for flowmeter 8039 (continued)



Two versions of the fitting in DN15 and DN20 exist, having different K factors. Only version 2, identified by the "v2" marking, is available from March 2012.

The "v2" marking can be found on the side of the DN15 or DN20 fitting in metal

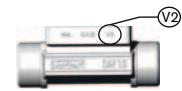

Fitting Type S039- Brass housing & PVDF paddle wheel holder (to be ordered separately)

Description	Item no. DN 06* - 1/4"	Item no. DN 06* - 1/25"	Item no. DN 08* - 1/2"	Item no. DN 15 - 1/2"	Item no. DN 20 - 3/4"	Item no. DN 25 - 1"	Item no. DN 32 - 1 1/4"	Item no. DN 40 - 1 1/2"	Item no. DN 50 - 2"
G-port connection	552 558	552 525	444 670	440 645	440 646	440 647	440 648	440 649	440 650
NPT-port connection	-	-	444 671	444 672	444 673	444 674	444 675	444 676	444 677
M-port connection	16 x 1.5 552 414	-	-	-	-	-	-	-	-

* Only version with external thread

Ordering chart - accessories for fitting S039 (to be ordered separately)

Specifications	Item no.
5-pin M12 female cable connector with plastic threaded locking ring	917 116
5-pin M12 female connector moulded on cable (2 m, shielded)	438 680
Cable plug EN 175301-803 with cable gland (Type 2508)	438 811
Cable plug EN 175301-803 with NPT1/2" reduction without cable gland (Type 2509)	162 673
Sensor armatures in PVDF with paddle wheel, FKM seal, screws for DN15 (except DN15 v2 and DN20 v2) to DN50	444 657
Sensor armatures in PVDF with paddle wheel, FKM seal, screws for DN06, DN08, DN15 v2 and DN20 v2	559 602

Interconnection possibilities with the 8039

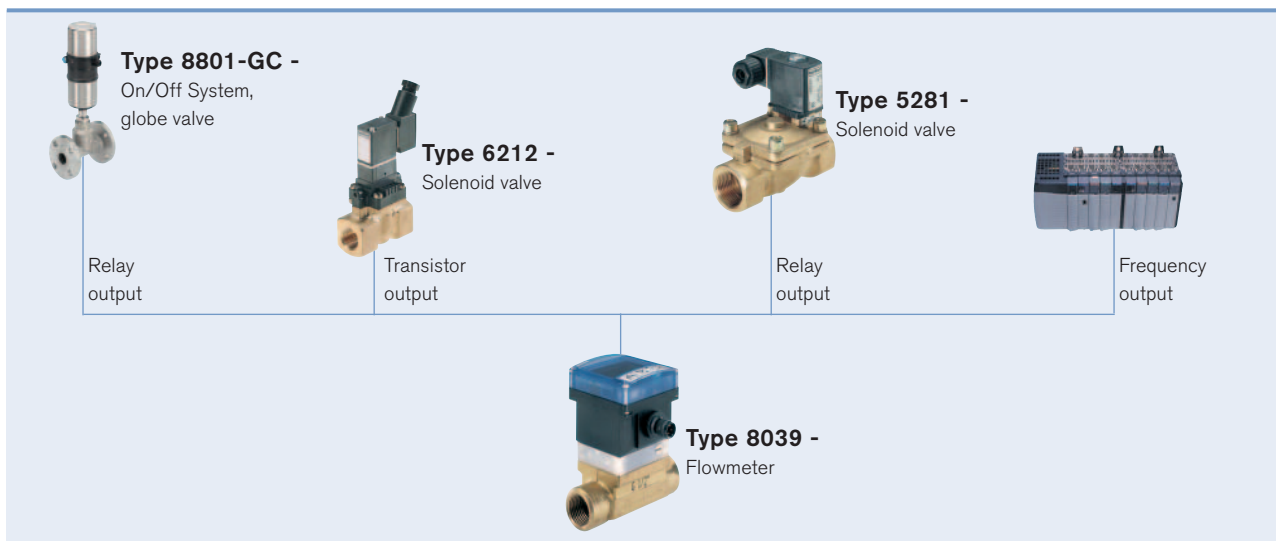

In case of special application conditions,
please consult for advice.

Subject to alteration.
© Christian Bürkert GmbH & Co. KG

1401/8_EU-en_00891788