



## AirLINE and AirLINE Quick – electrical/pneumatic Automation System – WAGO

Remote I/O and Fieldbus modules

- Fully compatible with WAGO I/O System 750
- Combination of Fieldbus, pilot valves and I/O modules
- higher flexibility in the control cabinet with AirLINE Quick
- Compact design
- High flow rate value

Type 8644 can be combined with...



**Type 8032**  
Switch



**Type 6212**  
Solenoid valve



**Type 2012**  
Process valve

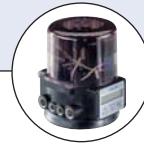



**Type 8630**  
Valve controller



**Type 1062**  
Position feedback

The AirLINE System integrates high performance solenoid pilot valves, remote electronic I/O and fieldbus communication into a process actuation and control system that is both compact and extremely flexible. Its modular design allows fully customized, pre-mounted and tested

solutions to exactly meet all application needs including the integration of a local Mini PLC. Due to the full electronic and mechanical integration, the valve block can be added without the need of any tools or wiring.

Technical data	Pilot valve	
	0460, 6524, 6525 	0461, 6526, 6527 
<b>width/station</b>	11 mm	16.5 mm
<b>Circuit function</b>	C (3/2) D (3/2) H (5/2) H (5/2) impulse L (5/3) in middle position all ports closed N (5/3) in middle position all ports vented	C (3/2) D (3/2) H (5/2) H (5/2) impulse L (5/3) in middle position all ports open N (5/3) in middle position all ports vented
<b>Flow rate</b>	300 l/min (200 l/min for functions H impulse, L and N)	700 l/min (500 l/min for functions H impulse, L and N)
<b>Pressure range</b>	Vac. up to 10 bar	Vac. up to 10 bar
<b>module types</b>	2x and 8x (optional integrated check valves and p-shut-off-valve)	2x and 4x (optional integrated check valves) Combination of 11 mm modules (3 valves) and 16.5 mm modules is possible
<b>Max. number of modules</b>	Depending on application	Depending on application
<b>Max. number of valves</b>	64 (by use of Type 0460 & Type 6524 2 x 3/2-way valve: 32)	32 (by use of Type 0461: 24)
<b>Pneumatic intermediate supply</b>	necessary after 24 valve functions; with 2 x 3/2-way valve: necessary after 16 valve functions	necessary after 16 valve functions
<b>Fieldbus type</b>	PROFIBUS DP, INTERBUS, DeviceNet, CANopen, Ethernet, further on request	PROFIBUS DP, INTERBUS, DeviceNet, CANopen, Ethernet, further on request
<b>Electrical modules</b>	WAGO I/O System 750	WAGO I/O System 750
<b>Digital modules</b>	2 or 4 inputs 2 or 4 outputs, others on request	2 or 4 inputs 2 or 4 outputs, others on request
<b>Analogue modules</b>	2 or 4 inputs (0-10 V, 0-20 mA, 4-20 mA, RTD, TC) 2 outputs (0-10 V, 0-20 mA, 4-20 mA) others on request	2 or 4 inputs (0-10 V, 0-20 mA, 4-20 mA, RTD, TC) 2 outputs (0-10 V, 0-20 mA, 4-20 mA) others on request

to be continued on page 2

Technical data	Pilot valve types	
	0460, 6524, 6525	0461, 6526, 6527
<b>Analogue modules</b>	2 or 4 inputs (0-10 V, 0-20 mA, 4-20 mA, RTD, TC) 2 outputs (0-10 V, 0-20 mA, 4-20 mA) others on request	2 or 4 inputs (0-10 V, 0-20 mA, 4-20 mA, RTD, TC) 2 outputs (0-10 V, 0-20 mA, 4-20 mA) others on request
<b>Operating voltage</b>	24 V/DC	24 V/DC
<b>Ripple</b>	1 Vss	1 Vss
<b>Nominal power per valve</b>	1 W (0.5 W nominal power after 120 ms)	2 W (1 W nominal power after 120 ms)
<b>Rated current per valve</b>	43 mA (28 mA holding current after 120 ms) 41mA (by use of Type 0460)	85 mA (52 mA holding current after 120 ms) 41mA (by use of Type 0461)
<b>Temperatures</b>		
Environment	0 to +55°C (by use of Type 0460: 0 to +50°C)	0 to +55°C (by use of Type 0461: 0 to +50°C)
Storage	-20 to +60°C	-20 to +60°C
<b>Protection class</b>	IP20 IP65 in closed field housing	IP20 IP65 in closed field housing
<b>Approvals</b>	Zone 2	on request

### Application example

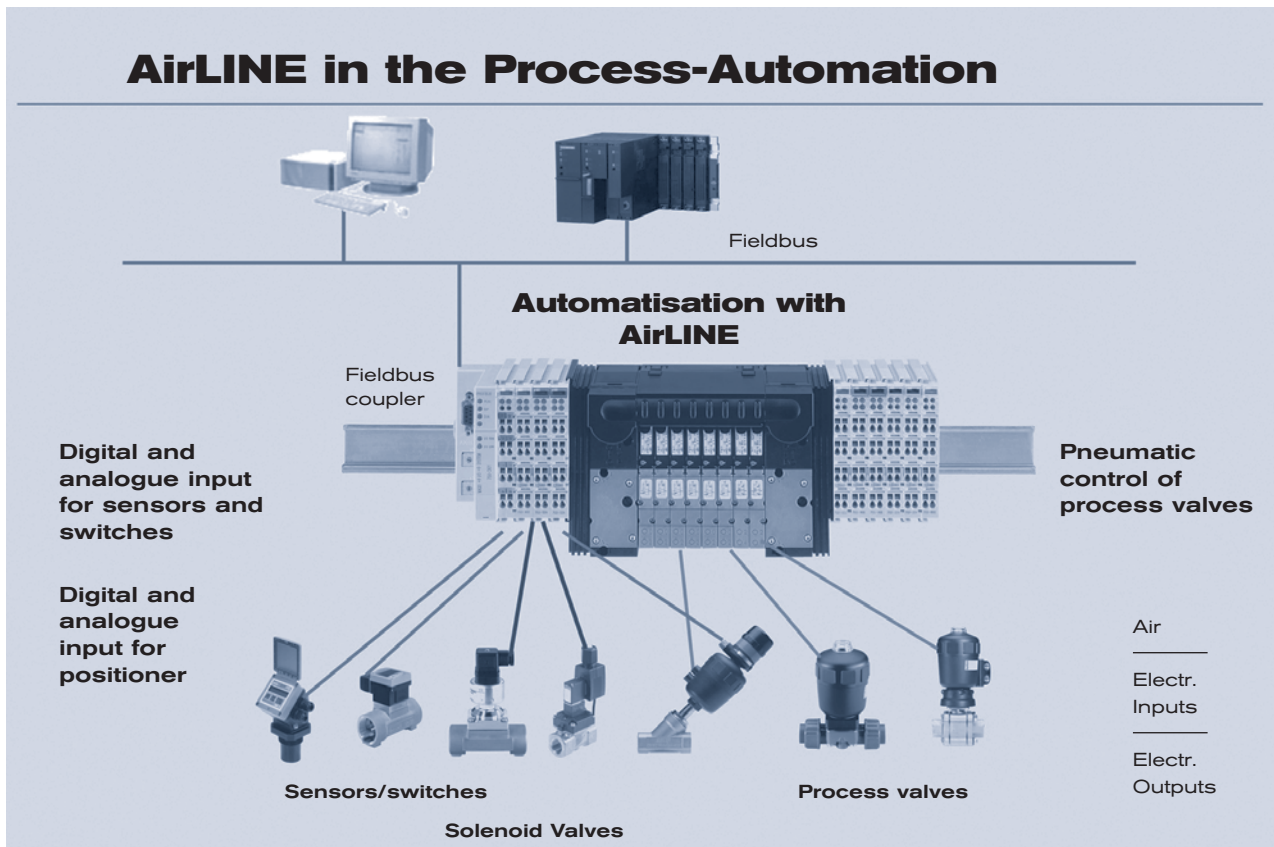

11 mm width/station Solenoid Valves 6524 and 6525



The solenoid valve Types 6524 and 6525 consist of a pneumatic valve body fitted with Type 6104 rocker pilot valve. The principle allows switching of high pressures together with low power consumption and fast response times. The pilot valves are equipped with manual override as a standard.

Specification	3/2-way valve	2 x 3/2-way valve
<b>Body material</b>	PA (Polyamide)	
<b>seal materials</b>	FPM, NBR and PUR	
<b>Medium</b>	lubricated and non lubricated dry compressed air; neutral gases (5 µm-Filter)	
<b>Port connections</b>	Flange for MP11	
<b>Pneumatic module</b>	Type MP11 with push-in connection Diameter 6 mm, D1/4 Threaded port M7	
<b>Manual override</b>	Standard	
<b>Operating voltage</b>	24 V DC	
<b>Nominal power</b>	0.8 W	2 x 0.8 W with reduction of power consumption
<b>Duty cycle</b>	Continuous operation (100% ED)	
<b>Electr. connection on valve</b>	Rectangular plug 2-pin grid spacing 5.08 mm	Rectangular plug 3-pin grid spacing 2.54 mm
<b>Mounting</b>	with 2 screws M2 x 20	with 2 screws M2 x 28
<b>Installation</b>	As required, preferably with actuator upright	
<b>Flow rate: QNn value air [l/min]</b>	Measured at +20°C, 6 bar pressure at valve inlet and 1 bar pressure difference	
<b>Pressure values [bar]:</b>	Overpressure with respect to atmospheric pressure	
<b>Response times [ms]:</b>	Measured according to ISO 12238	

Ordering chart for valves

Control function	Orifice [mm]	QNn value air [l/min]	Pressure range [bar]	Response times		Voltage/Frequency [V/Hz]	Item no.
				Opening [ms]	Closing [ms]		
<b>C</b>  3/2-way valve, pilot-controlled, currentless Port 2 decreased	4	300	Vac.-7	15	20	24 V DC *	186 258
			1-10 <sup>1)</sup>	15	20	24 V DC *	186 257
			2,5-10	15	28	24 V DC *	184 043
<b>D</b>  3/2-way valve, pilot-controlled, currentless Port 2 pressurised			2,5-10	15	28	24 V DC *	184 400
<b>H</b>  5/2-way valve, pilot-controlled, currentless Port 1 connected to port 2, port 4 exhausted	4	300	1,0-10 <sup>1)</sup>	15	20	24 V DC *	186 271
			2, 5-10	20	28	24 V DC *	179 938
<b>C</b>  3/2-way valve, pilot-controlled, currentless Port 2/4 decreased	4	300	1,0-10 <sup>1)</sup>	12	20	24 V DC *	186 259 <sup>2)</sup>
			2,5-10	12	20	24 V DC *	186 260 <sup>2)</sup>

<sup>1)</sup> Version with auxiliary pilot air

<sup>2)</sup> Version with integrated reduction of power consumption

\* 10% residual ripple allowed

11 mm width/station: pilot valve Type 0460



The solenoid valve Type 0460 consists of a pneumatic valve body fitted with a double coil pilot valve. The principle allows switching of high pressures together with low power consumption and fast response times. All valves are equipped with manual override as a standard.

Technical data	
Body material	Aluminium
Seal material	NBR
Medium	lubricated and non lubricated dry compressed air; Neutral gases (5µm filter recommended)
Port connections	Flange
Pneumatic module	MP11
Supply port connection 1 (P), 3 (R), 5 (S)	G 1/4 NPT 1/4 Push-in Ø 10 mm
Service port 2 (A), 4 (B)	Push-in Ø 6 mm Push-in Ø 1/4" Threaded port M7
Operating voltage	24 V/DC
Electrical connection at the valve	Rectangular plug
Manual override	standard
Flow rate: QNn value air [l/min]	Measured at +20°C, 6 bar pressure at valve inlet and 1 bar pressure difference
Pressure values [bar]	Measured as overpressure to the atmospheric pressure
Response times [ms]	Measured according to ISO 12238

Ordering chart for valves

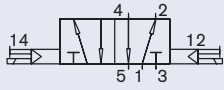
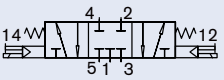
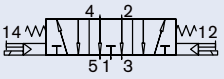
Control function	Orifice [mm]	QNn value air [l/min]:	Pressure range [bar]	Nominal power [W]	Response times		Item no.
					OPENING [ms]	Closing [ms]	
 <p>5/2-way valve, pilot-controlled, Impulse version</p>	2,5	200	2,0-7,0	1	15	15	154 183
 <p>5/3-way-valve, pilot-controlled, in middle position all ports locked</p>	2,5	200	2,0-7,0	1	15	20	154 184
 <p>5/3-way-valve, pilot-controlled, in middle position port 2 and 4 exhausted</p>	2,5	200	2,0-7,0	1	15	20	154 185

16,5mm width/station Solenoid Valves 6526 and 6527



The solenoid valve Types 6526 and 6527 consist of a pneumatic valve body fitted with Type 6106 rocker pilot valve. The principle allows switching of high pressures together with low power consumption and fast response times. The pilot valves are equipped with manual override as a standard.

Specification	
Body material	PA (Polyamide)
seal materials	NBR
Medium	lubricated and non lubricated dry compressed air; neutral gases (10 µm filter)
Port connections	Flange for MP12
Pneumatic module	Type MP12 with G 1/8, Push-in Ø 8 mm NPT 1/8
Manual override	Standard
Operating voltage	24 V DC
Nominal power	2 W, 1W
Duty cycle	Continuous operation 100%
Electr. connection on valve	Tag connector acc. to DIN EN 175301-803 (previously DIN 43650) Form C
Mounting	with 2 screws M3 x 30
Installation	As required, preferably with actuator upright
Flow rate: QNn value air [l/min]:	Measured as overpressure to the atmospheric pressure 1 bar pressure difference
Pressure values [bar]	Measured as overpressure to the atmospheric pressure
Response times [ms]	Measured according to ISO 12238

Ordering chart for valves

Control function	Orifice [mm]	QNn value air [l/min]	Pressure range [bar]	Nominal power [W]	Response times		Voltage/Frequency [V/Hz]	Item no.
					Opening [ms]	Closing [ms] <sup>3)</sup>		
<b>C</b>  3/2-way valve, pilot-controlled, currentless, Port 2 decreased	6	700	1,0 - 10 <sup>1)</sup>	2	20	12	24 V DC	156 842
			1,0 - 10 <sup>1)</sup>	2	20	12	24 V DC	163 028 <sup>2)</sup>
			2,0 - 10	2	20	12	24 V DC	156 318
			2,0 - 10	2	20	12	24 V DC	158 944 <sup>2)</sup>
			2,0 - 8,0	1	20	17	24 V DC	156 840
			2,0 - 8,0	1	20	12	24 V DC	158 947 <sup>2)</sup>
<b>D</b>  3/2-way valve, pilot-controlled, currentless, Port 2 pressurized	6	700	1,0 - 10 <sup>1)</sup>	2	20	12	24 V DC	163 029 <sup>2)</sup>
			2,0 - 10	2	12	20	24 V DC	156 320
			2,0 - 10	2	20	12	24 V DC	158 946 <sup>2)</sup>
			2,0 - 8,0	1	17	20	24 V DC	156 841
<b>H</b>  5/2-way valve, pilot-controlled, currentless, Port 1 connected to port 2, port 4 exhausted	6	700	1,0 - 10 <sup>1)</sup>	2	20	12	24 V DC	156 828
			1,0 - 10 <sup>1)</sup>	2	20	12	24 V DC	163 030 <sup>2)</sup>
			2,0 - 10	2	20	12	24 V DC	156 337
			2,0 - 10	2	20	12	24 V DC	158 942 <sup>2)</sup>
			2,0 - 8,0	1	20	17	24 V DC	156 827
			2,0 - 8,0	1	20	12	24 V DC	158 943 <sup>2)</sup>

<sup>1)</sup> Version with auxiliary pilot air

<sup>2)</sup> Electric connection with manual override.

<sup>3)</sup> Closing time approx. 5 ms higher when used together with valve unit

16,5 mm width/station: pilot valve Type 0461



The solenoid valve Type 0461 consists of a pneumatic valve body fitted with a double coil pilot valve. The principle allows switching of high pressures together with low power consumption and fast response times. All valves are equipped with manual override as a standard.

Technical data	
<b>Body material</b>	Aluminium
<b>Seal material</b>	NBR
<b>Medium</b>	lubricated and non lubricated dry compressed air; neutral gases (10µm filter recommended)
<b>Port connections</b>	Flange
<b>Pneumatic module</b>	MP12
<b>Supply port connection 1 (P), 3 (R), 5 (S)</b>	G 3/8 NPT 3/8
<b>Service port 2 (A), 4 (B)</b>	G 1/8 NPT 1/8 Push-in connection Ø 8 mm
<b>Operating voltage</b>	24 V/DC
<b>Electrical connection at the valve</b>	Rectangular plug
<b>Manual override</b>	standard
<b>Flow rate: QNn value air [l/min]</b>	Measured at +20°C, 6 bar pressure at valve inlet and 1 bar pressure difference
<b>Pressure values [bar]</b>	Measured as overpressure to the atmospheric pressure
<b>Response times [ms]</b>	Measured according to ISO 12238

Ordering chart for valves

Circuit function	Orifice [mm]	QNn value air [l/min]:	Pressure range [bar]	Nominal power [W]	Response times		Item no.
					OPENING [ms]	Closing [ms]	
<p>5/2-way valve, pilot-controlled, Impulse version</p>	6	500	2,5-7,0	1	20	30	156 766
<p>5/3-way-valve, pilot-controlled, in middle position all ports locked</p>	6	500	2,5-7,0	1	15	50	156 767
<p>5/3-way-valve, pilot-controlled, in middle position port 2 and 4 exhausted</p>	6	500	2,5-7,0	1	15	50	156 768

**AirLINE Quick**

With AirLINE Quick you can reduce the amount of the components in the control cabinet considerably. With the AirLINE Quick Adapter the valve island is directly adapted on the control cabinet floor or wall.

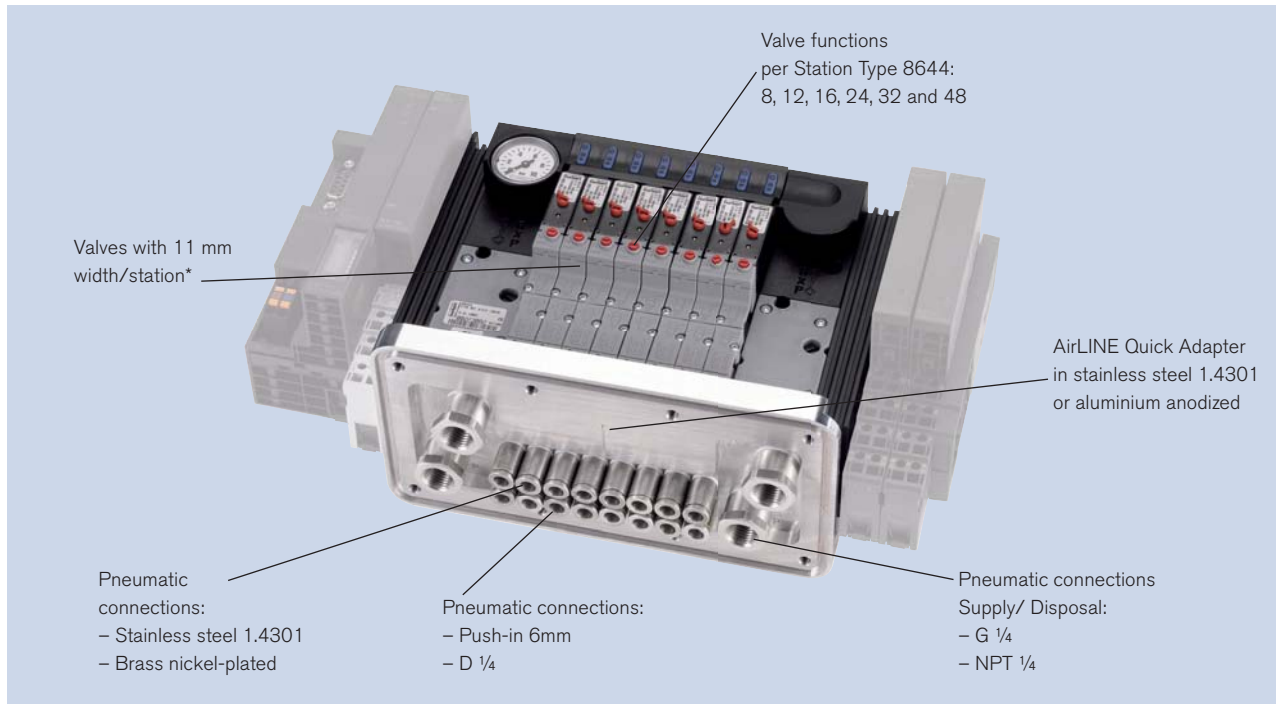

\* The valves of Type 0460 can not be installed with AirLINE Quick because of their size.

**Technical data**

Technical data	
<b>Material AirLINE Quick Adapter</b>	stainless steel 1.4301 aluminium anodized
<b>Material pneumatic connection</b>	stainless steel 1.4301 Brass nickel-plated
<b>Connection pneumatic feeding</b>	G 1/4, NPT 1/4
<b>Connection pneumatic service ports</b>	Push-in D6 mm, D1/4"
<b>Installation</b>	Control cabinet wall Control cabinet floor
<b>Valve functions per station</b>	8, 12, 16, 24, 32 and 48



## Additional accessories for AirLINE Quick

### Blanking plates

A blanking plate is used to cover an existing flange for AirLINE Quick on the cabinet wall or on the cabinet floor.

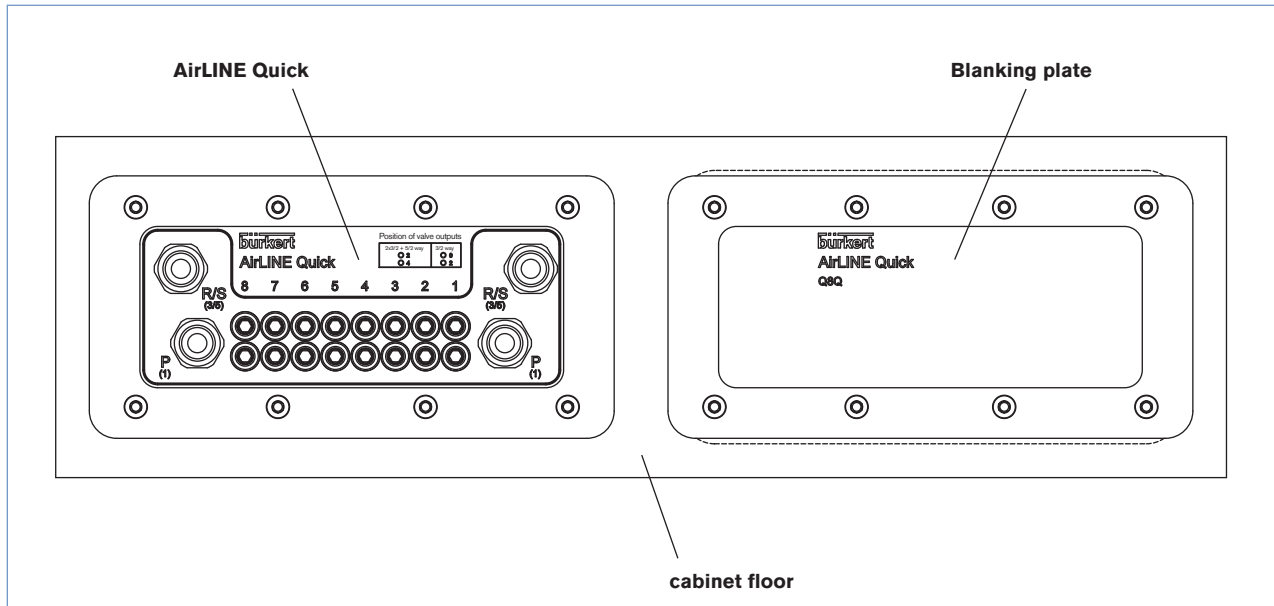

### Ordering chart blanking plates

Material	Amount of valve slots	Item no.
Aluminium anodized	8	246 933
	12	246 929
	16	246 925
	16*	246 935
	24	246 927
Stainless steel 1.4301	24*	246 931
	8	246 934
	12	246 930
	16	246 926
	16*	246 936
	24	246 928
	24*	246 932

\* with intermediate pneumatic supply module



Integration of AirLINE Quick in WAGO I/O System 750

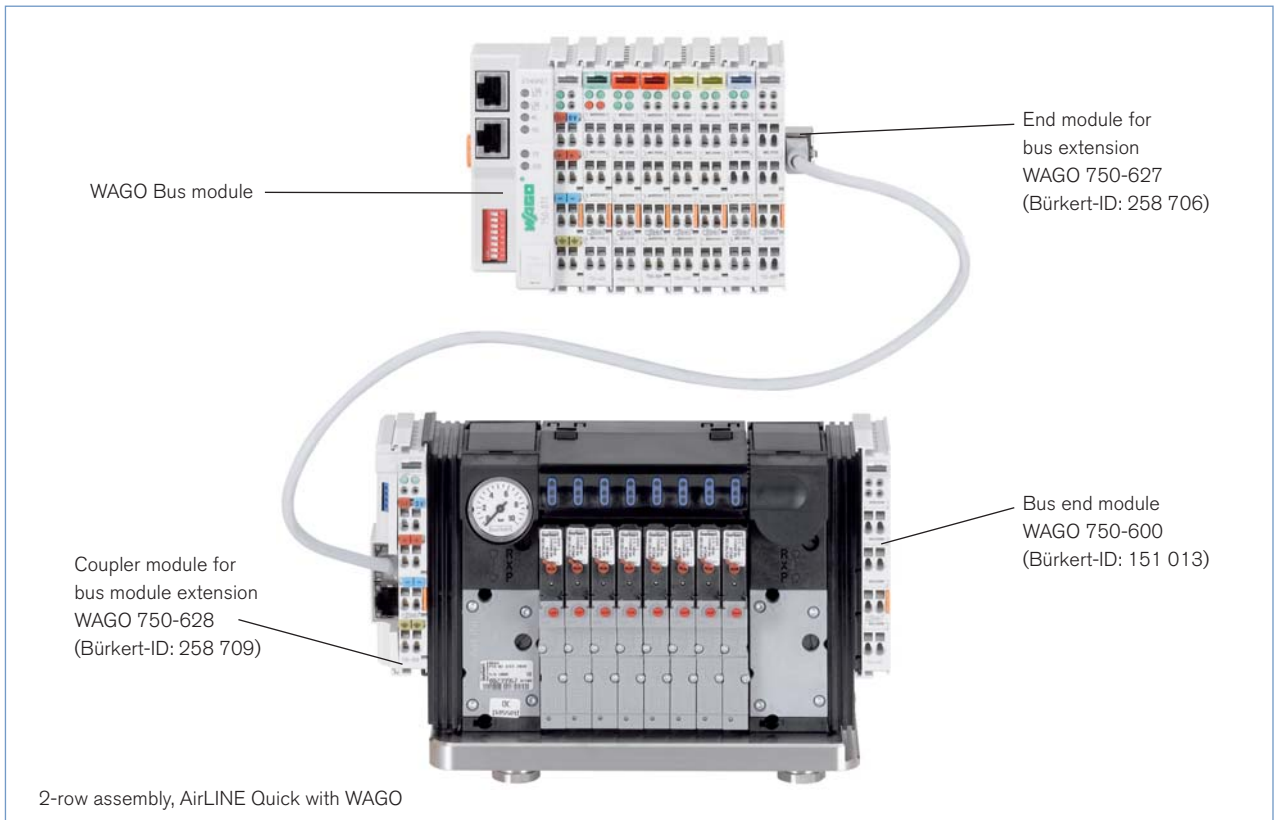

Pneumatic module and electrical interfaces for modules series 750 WAGO

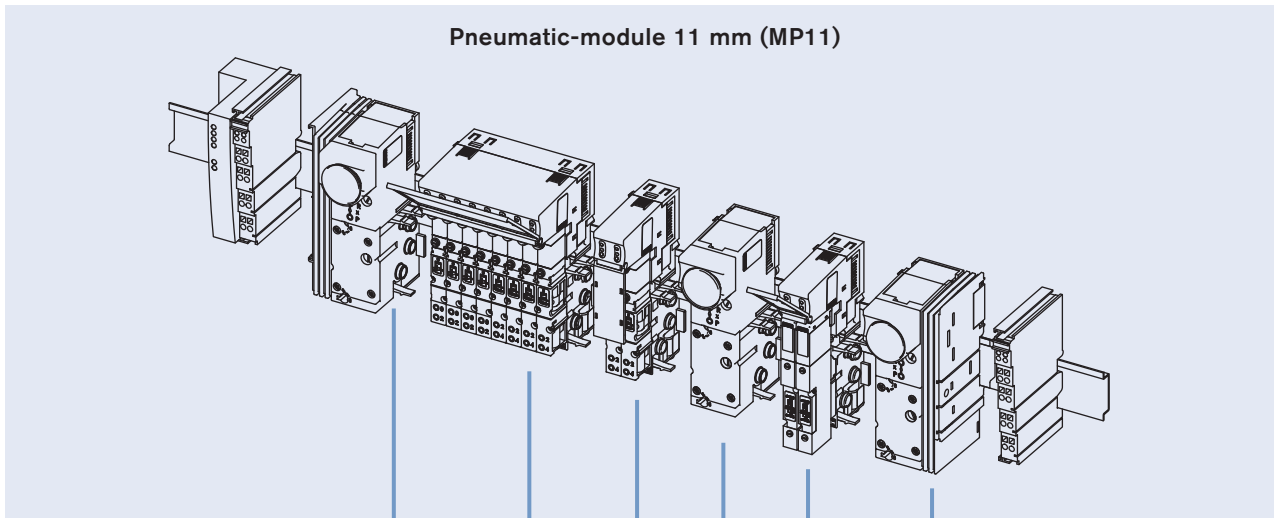

**Connector module "left",  
with or without pressure gauge**  
Threaded port G 1/4  
Threaded port NPT 1/4  
Push-in Ø 10 mm

**Pneumatic basic module,  
electrical basic module & pilot valve**  
**8 valves  
(8 x 11 mm)**

**Service port 2 (A), 4 (B)**  
Push-in Ø 6 mm  
Push-in Ø 1/4"  
Threaded port M7

**2-fold (2 x 11 mm)**  
**Service port 2 (A), 4 (B)**  
Push-in Ø 6 mm  
Push-in Ø 1/4"  
Threaded port M7

**Connector module "right",  
with or without pressure gauge**  
Threaded port G 1/4  
Threaded port NPT 1/4  
Push-in Ø 10 mm

**Pneumatic basic module,  
electrical basic module & pilot valve**  
**2-fold (8 x 11 mm)**

**Service port 2 (A), 4 (B)**  
Push-in Ø 6 mm  
Push-in Ø 1/4"  
Threaded port M7

**Intermediate module,  
with or without pressure gauge**  
Threaded port G 1/4  
Threaded port NPT 1/4  
Push-in Ø 10 mm

Pneumatic module and electrical interfaces for modules series 750 WAGO

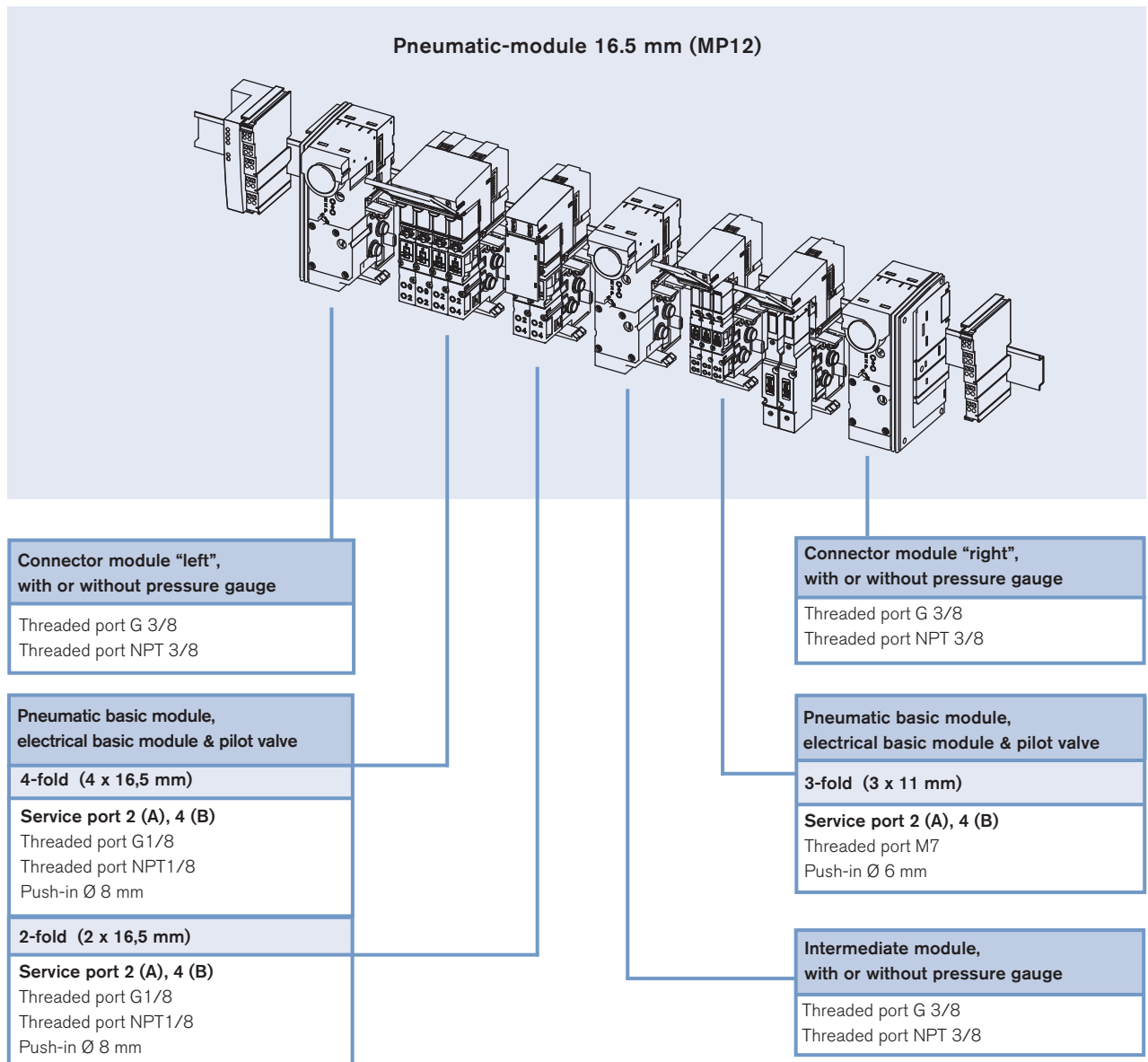

Dimensions [mm]

width/station 11 mm, with Type 6524 / 6525

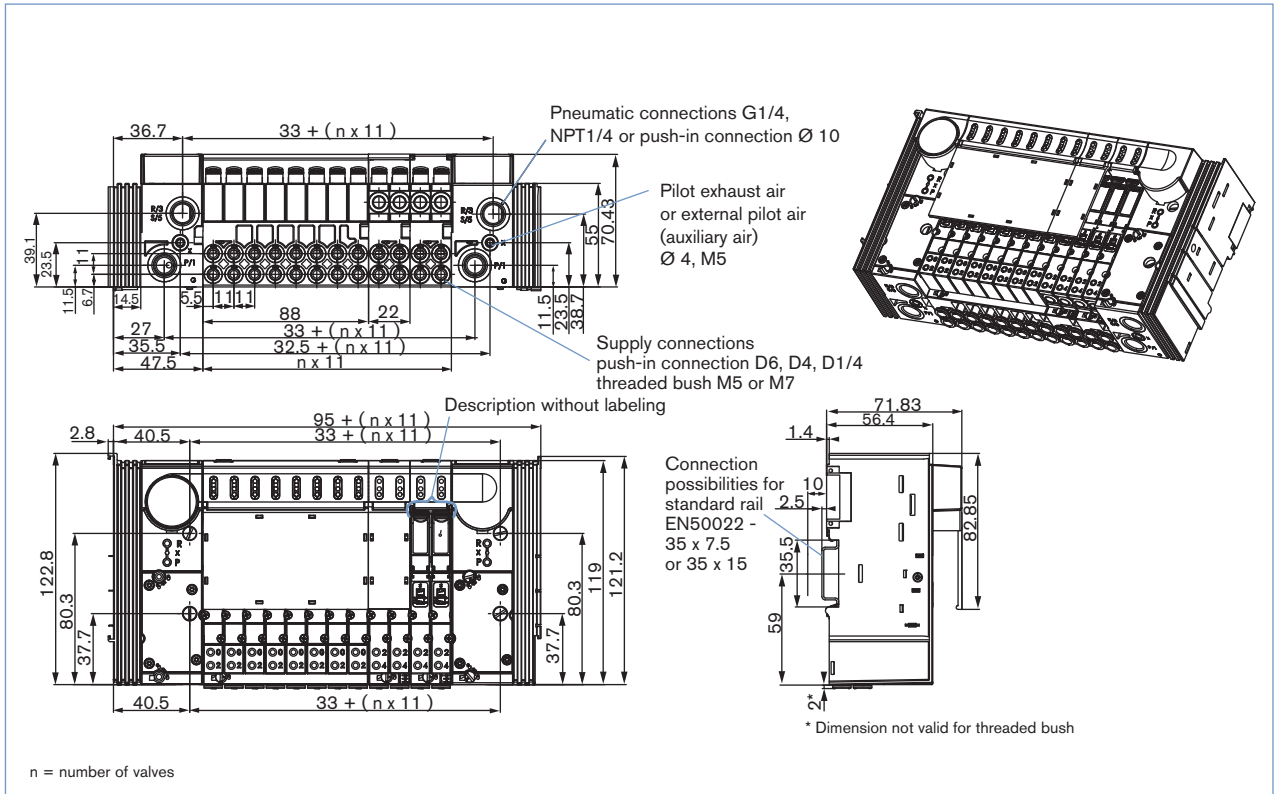

width/station 11 mm, with Type 6524 2 x 3/2-way valve

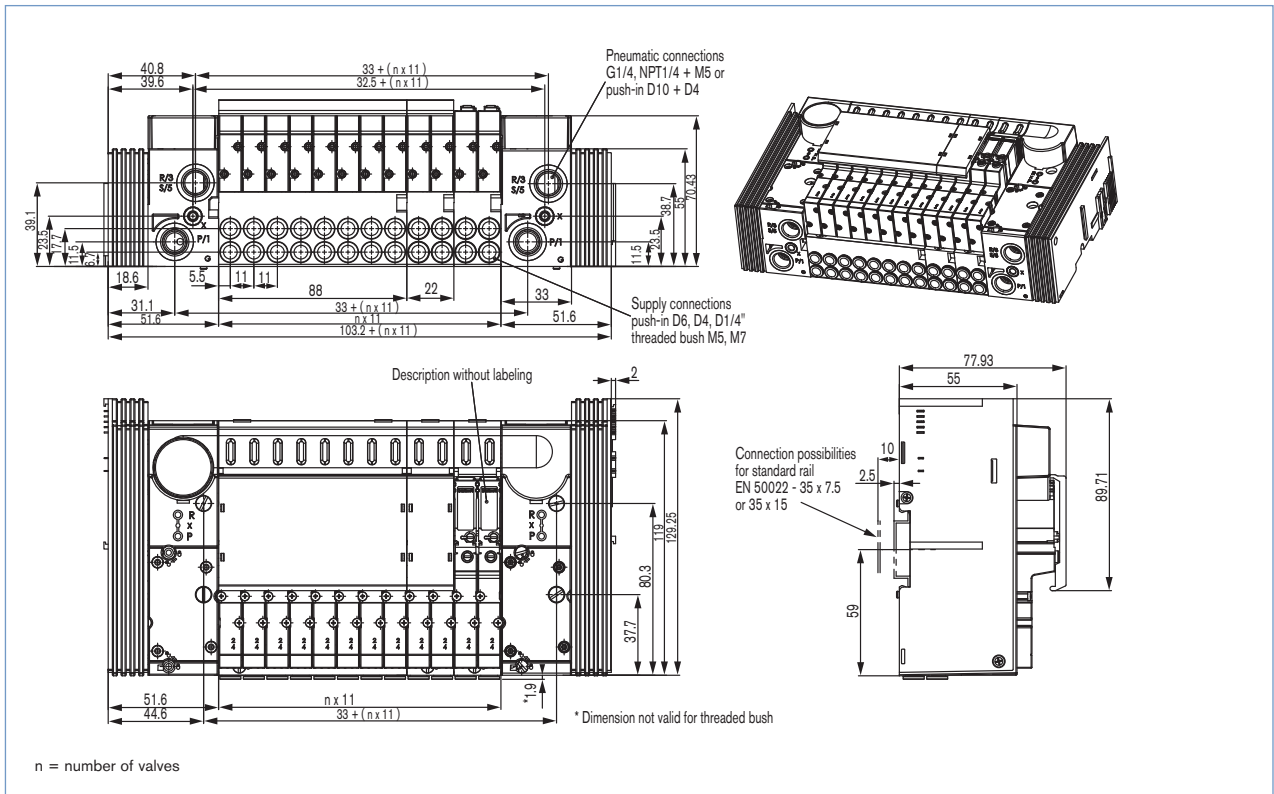

Dimensions [mm]

width/station 16,5 mm, for Type 6526 / 6527

