

SE56 standard
with display,
Housing in
stainless steel

SE56 basic



SE56 blind

Electronics for electromagnetic flowmeters

- Must be equipped with sensor fitting S051, S054, S055 or S056
- Continuous measurement or batch control
- High accuracy
- Data logger, PROFIBUS DP, HART available

Type SE56 must be combined with...

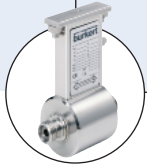
**Type S051**

Magnetic sensor fitting
- for low flow

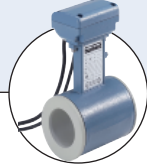
**Type S054**

Magnetic sensor fitting
- Wafer

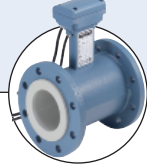
**Type S055**

Magnetic sensor fitting
- Flange

**Type S056**

Magnetic sensor fitting
- Hygienic

The electronics Type SE56 (blind in compact version or with display in compact or remote version) connected to the magnetic flow sensor fitting Type S051, S054, S055 or S056 is designed for applications with liquids with a minimum conductivity of 5 $\mu\text{S}/\text{cm}$.

The device can be parameterize either with 3 keypads (version with display) or by computer via a serial interface.

As standard, the equipment is supplied with one or two transistor outputs and one digital input. As options, other features are available: such as high frequency output, current output, data logger 2 MB, PROFIBUS DP, HART.

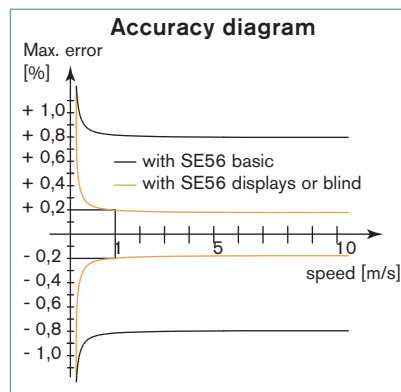

Technical data (electronics SE56 standard with display)



Compatibility	S051, S054, S055, S056 sensor fitting (see separate data sheet 8051, 8054/8055, 8056)
Housing materials	Die casting aluminium or stainless steel 304 electro-polish
Display	Graphic display 8 lines x 16 Characters, 128 x 64 pixels with back light
Keyboard	3 membrane keys
Electrical connection	6 cable glands PG11



Medium temperature, please see separate data sheets of the complete magflowmeter 8051, 8054/8055, 8056

Environment

Ambient temperature Operating and storage	-20 to +60°C (-4 to 140°F)
Relative humidity	≤ 85%, without condensation
Height above sea level	-200 to 6000 m

Standard

Protection	Class I, IP67, category of installation II
Standard	
EMC	EN 61326-1
Emission	EN 55011 (Group1, Class B)
Immunity	IEC 1000-4-2/3/4/5/6/11
Safety	EN 61010

Technical data (electronics SE56 standard with display) - continued

Electrical data	
Power supply	90... 265 V AC - 44 Hz to 66 Hz
Power consumption	max. 25 VA
Cable length	max. 20 m (distance between sensor fitting and electronics)
Input circuit	1 digital, selectable function
Outputs	
Transistor	2 outputs, selectable open collector as pulse/frequency (1250 Hz, 100 mA, 40 V DC) or alarm (adjustable usage)
Current	1 output, 4... 20 mA - RL = 1000 Ω (+ a second output)*
Serial interface*	RS 485, RS232, PROFIBUS DP or HART
Datalogger*	2 MB, 32 values + 64 alarm events
Velocity range	0.4... 10 m/s

* on request.

Electrical data (continued)	
Measurements tolerance	Flow rate (volume) = ±0.05% of reading Out 4/20 mA = ±0.08% of reading Frequency out = ±0.08% of reading
Accuracy ¹⁾	±0.2% of reading (see diagram, on page 1)
Repeatability	±0.1% of reading
Galvanic isolation	All the input/outputs are galvanically isolated from power supply
Data storage	An EEPROM stores the measured values (in case of power failure)
Special functions	Bidirectional measure Dual measurement range Diagnostic function Empty pipe detection Remote configuration (for connection to PC or hand terminal through remote configuration tool kit) Batch function

¹⁾ under reference conditions: water temperature = 20°C, ambient temperature = 25°C, constant flow rate during the test, liquid speed > 1 m/s

Technical data (electronics SE56 blind)



General data	
Compatibility	S051, S054, S055, S056 sensor fitting (see separate data sheet 8051, 8054/8055, 8056)
Materials	
Housing	Stainless steel
Cover	PPS
Seal	EPDM
Display	None
Parameterization	Through remote configuration tool kit (accessories Item No. 559 374)
Electrical connection	2 cable glands PG9



Medium temperature, please see separate data sheets of the complete magflow-meter 8051, 8054/8055, 8056

Electrical data	
Power supply	20... 30 V DC
Power consumption	max. 10 W
Input	1 digital, selectable function
Outputs	
Transistor	2 outputs, selectable open collector as pulse/frequency (1250 Hz, 100 mA, 40 V DC) or alarm (adjustable usage)
Current	1 output, 4... 20 mA - RL = 800 Ω passive
Serial interface*	RS 485 or PROFIBUS DP

* on request.

Electrical data (continued)	
Accuracy ¹⁾	±0.2% of reading (see diagram, on page 1)
Repeatability	±0.1% of reading
Galvanic isolation	All the input/outputs are galvanically isolated from power supply
Data storage	An EEPROM stores the measured values (in case of power failure)
Special functions	Bidirectional measure Diagnostic function Empty pipe detection Remote configuration (for connection to PC or hand terminal) Batch function
Velocity range	0.4... 10 m/s

Environment	
Ambient temperature	
Operating and storage	-20 to 40°C (-4 to 104°F)
Relative humidity	≤ 85%, without condensation
Height above sea level	-200 to 6000 m

Standard	
Protection	Class I, IP67, category of installation II
Standard	
EMC	EN 61326-1
Emission	EN 55011 (Group1, Class B)
Immunity	IEC 1000-4-2/3/4/5/6/11
Safety	EN 61010

Technical data (electronics SE56 basic)



General data

Compatibility	S051, S054, S055, S056 sensor fitting (see corresponding data sheet)
Materials Housing	PA6 with glass fibre
Display	Alphanumeric display 2 lines x 16 Characters, without back light
Parameterization	Through remote configuration tool kit (accessories Item No. 559 374) or 3 keys inside
Electrical connection	3 cable glands PG11



Medium temperature, please see separate data sheets of the complete magflow-meter 8051, 8054/8055, 8056

Electrical data

Power supply	90... 265 V AC or 12... 60 V DC
Power consumption	max. 6 W
Input	1 digital, selectable function
Outputs Transistor	2 outputs, selectable open collector as pulse/frequency (1250 Hz, 100 mA, 40 V DC) or alarm (adjustable usage)
Current	1 output, 4... 20 mA - RL = 800 Ω passive
Serial interface*	RS 485

* on request.

Electrical data (continued)

Measurements tolerance	Flow rate (volume) = $\pm 0.1\%$ of reading Out 4/20 mA = $\pm 0.12\%$ of reading Frequency out = $\pm 0.12\%$ of reading
Accuracy	$\pm 0.8\%$ of reading (see diagram, on page 1)
Repeatability	$\pm 0.2\%$ of reading
Galvanic isolation	All the input/outputs are galvanically isolated from power supply
Data storage	An EEPROM stores the measured values (in case of power failure)
Special function	Bidirectional measure Diagnostic function Empty pipe detection Plug in (protected plug for connection to PC or hand terminal)
Velocity range	0.4... 10 m/s

Environment

Ambient temperature Operating	-10 to 50°C (14 to 122°F)
Storage	-20 to 50°C (-4 to 122°F)
Relative humidity	$\leq 85\%$, without condensation
Height above sea level	-200 to 6000 m

Standard

Protection	Class I, IP65, category of installation II
Standard EMI Safety	EN 55011 (Group 1, Class B) EN 61326-1, IEC 1000-4-2/3/4/5/6/11 EN 61010

Dimensions [mm]

Electronics SE56 blind

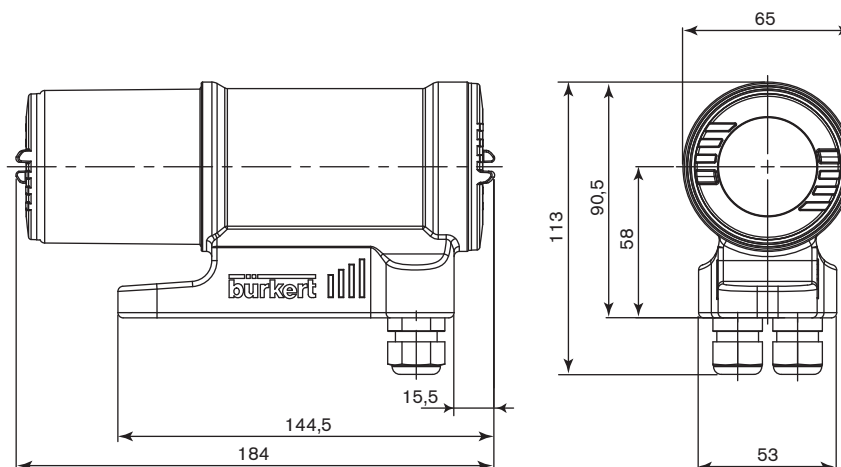

Dimensions [mm]

Electronics SE56 Basic

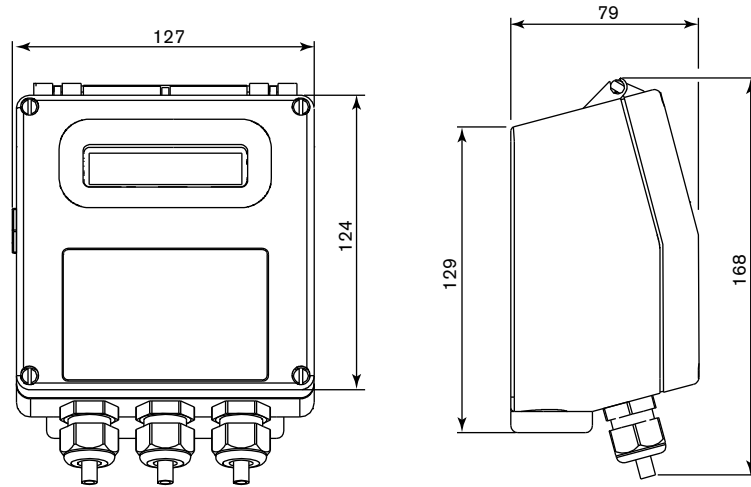

Electronics SE56 standard with display

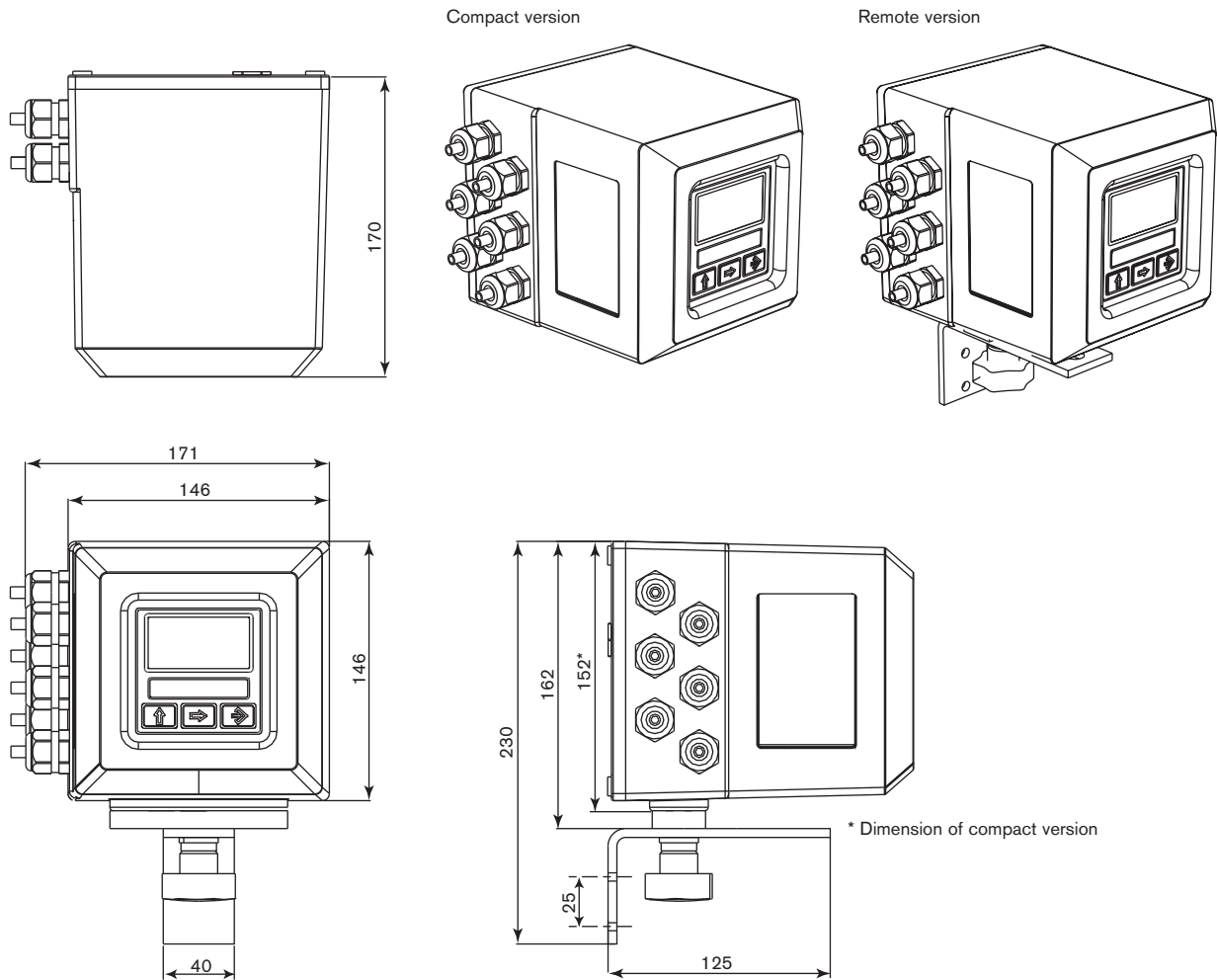

Ordering information for complete full bore magflowmeter Type 8051, 8054/8055 or 8056

A complete full bore magflowmeter consists of a sensor fitting and an electronics SE56.

Examples for variations of complete full bore magflowmeter (electronics + sensor fitting)

Electronics Type SE56

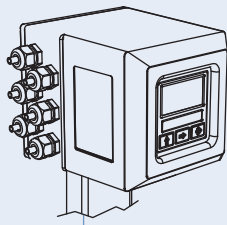

Standard with display
compact version

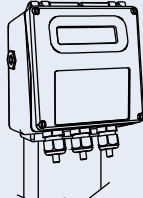

Basic (with or without display)
compact version

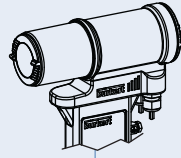

Without display (blind)
compact version

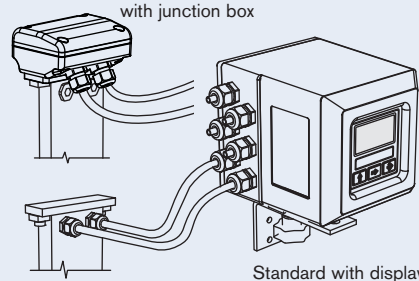

Standard with display
remote version

Magflowmeter Type 8051

More info.

For more technical information about this product, click on this box... you will come to our website for this product where you can download the datasheet.

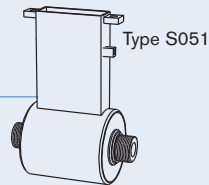

Compact version
sensor fitting

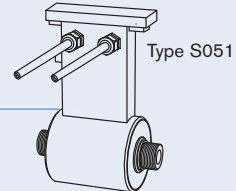

Remote version
sensor fitting

Magflowmeter Type 8054/8055

More info.

For more technical information about this product, click on this box... you will come to our website for this product where you can download the datasheet.

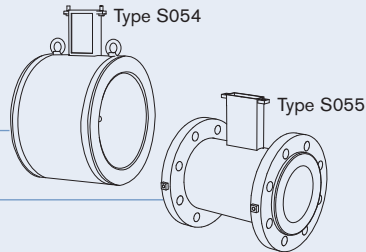

Compact version
sensor fitting

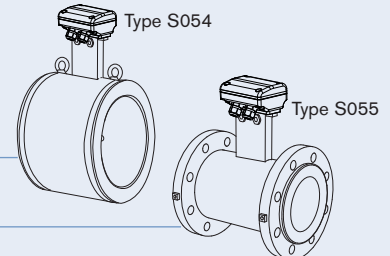

Remote version
sensor fitting

Magflowmeter Type 8056

More info.

For more technical information about this product, click on this box... you will come to our website for this product where you can download the datasheet.

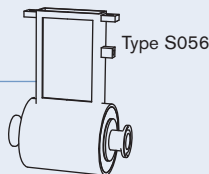

Compact version
sensor fitting

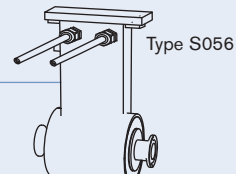

Remote version
sensor fitting

The following information is necessary for the selection of a complete full bore magflowmeter:

- **item no.** of the sensor fitting **Type S051, Type S054/Type S055 or Type S056** (see separate data sheets of the complete magflowmeter 8051, 8054/8055, 8056)
- **item no.** of the electronics **Type SE56** (Ordering chart on page 6)

Ordering chart for electronics Type SE56 for magflowmeter

Description	Power supply	Output	Body material	Electrical connection	Item no.
Standard compact version with display	90... 265 V AC	2 transistors	Aluminium	6 cable glands	558 745
			Stainless steel	6 cable glands	559 780
		2 transistors + 4... 20 mA	Aluminium	6 cable glands	558 747
			Stainless steel	6 cable glands	558 306
Standard wall-mounting version with display	90... 265 V AC	2 transistors	Aluminium	6 cable glands	559 781
			Stainless steel	6 cable glands	558 310
		2 transistors + 4... 20 mA	Aluminium	6 cable glands	558 750
			Stainless steel	6 cable glands	558 308
Basic compact version with display	90... 265 V AC	2 transistors	Nylon	3 cable glands	562 439
		2 transistors + 4... 20 mA	Nylon	3 cable glands	562 440
	12... 60 V DC	2 transistors	Nylon	3 cable glands	562 443
		2 transistors + 4... 20 mA	Nylon	3 cable glands	562 444
Basic compact version without display	90... 265 V AC	2 transistors	Nylon	3 cable glands	562 441
		2 transistors + 4... 20 mA	Nylon	3 cable glands	562 442
	12... 60 V DC	2 transistors	Nylon	3 cable glands	562 445
		2 transistors + 4... 20 mA	Nylon	3 cable glands	562 446
Blind compact version	20... 30 V DC	up to 4 transistors	Stainless steel	2 cable glands	559 132
		up to 4 transistors + 4... 20 mA	Stainless steel	2 cable glands	559 133
		up to 4 transistors + PROFIBUS DP	Stainless steel	2 cable glands	559 134

i Further versions on request

Please also use the "request for quotation" form on page 7 for ordering a customized electronics [go to page](#).

Ordering chart - accessories

Description	Item no.
Remote configuration tool kit	559 374

Configuration accessories

Remote configuration tool kit

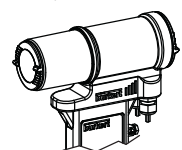
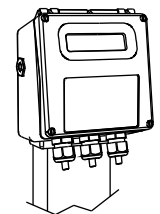
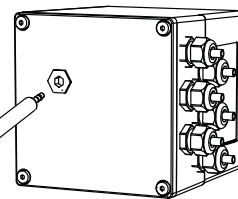
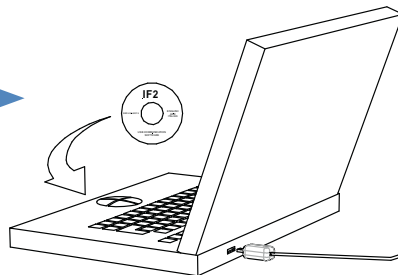

Electronics Type SE56 for magflowmeter - request for quotation

Note

You can fill out the fields directly in the PDF file before printing out the form.

Please fill out and send to your nearest Bürkert facility* with your inquiry or order.

NOTE : Please take into account that the electronics Type SE56 must be associated with a sensor fitting Type S051, S054, S055 or S056.

Company:	Contact person:
Customer No.:	Department:
Address:	Tel. / Fax.:
Postcode / Town:	E-mail:

Electronics SE56 standard with display

Quantity: Desired delivery date:

■ Mounting version

 Compact Wall-mounting Panel-mounting (body only in plastic)

■ Body material

 Aluminium Stainless steel

■ Power supply

 90... 265 V AC 18... 63 V DC / 15... 45 V AC 10... 35 V DC

■ Outputs

 4... 20 mA RS 485 PROFIBUS DP 2 transistors 2 transistors + 4... 20 mA 2 transistors (one of them: 10 KHz) 2 transistors + 1 x RS 232 2 transistors + 4... 20 mA + 1 x RS 232 Data Logger 2 MB HART Protocol 2 Relays 60 V AC 2 Relays 250 V AC

Electronics SE56 blind, compact, in stainless steel, 20... 30 V DC

Quantity: Desired delivery date:

■ Outputs

 4... 20 mA RS 485 PROFIBUS DP

Electronics SE56 basic, compact, in plastic

Quantity: Desired delivery date:

■ Display

 With Without

■ Power supply

 90... 265 V AC 12... 60 V DC / 18... 45 V AC

■ Outputs

 4... 20 mA RS 485