

**Maintenance**

Maintenance is necessary in case of valve failure only (no function rightness, no tightness). Preventive maintenance is advised in case of worse operating conditions, often initializing of valve or by medium pollution.

Maintenance work must be carried out only by the absence of pressure in the pipeline and with solenoid disconnected from the voltage supply.

After valve repair or replacing test the valve with 1,5 multiple of maximum operating pressure. Valve should be not initializing by testing, valve could be opened or closed by testing.

Upon request, manufacturer is able to supply some kinds of spare parts and brochures with sectional drawing and assembly instructions. By coil ordering is it necessary to set number and kind of voltage (AC or DC).

**Guarantee and Service**

The manufacturer is responsible for the solenoid valve properties during 12 months since delivery. In case of any claim it is required to present the solenoid valve, a document about buying (payment receipt) and these Installation, Service and Maintenance Instructions. The guarantee is not approved if the damages are caused by inappropriate impact to the regulator or with not following these Instructions.

Under-and out-of –guarantee repairs can be performed by the manufactures.

**Product liquidation**

Components and pack can be used as source of secondary raw material.

Product is not source of environmental pollution and doesn't include danger scrap.

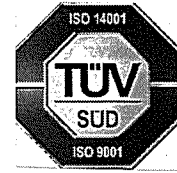

## **INSTALLATION, SERVICE AND MAINTENANCE INSTRUCTION**

**2-way solenoid valve direct acting**  
**3-way solenoid valve direct acting**  
**Normally closed ( NC )**

<b>Type: 2 SVE 1,2 M</b>	<b>3 SVE 1,2 M</b>
<b>2 SVE 1,6 M</b>	<b>3 SVE 1,6 M</b>
<b>2 SVE 2 M</b>	<b>3 SVE 2 M</b>
<b>2 SVE 2,5 M</b>	

REGADA, s. r. o., Strojnícka 7  
080 01 Prešov, Slovenská republika  
Tel.: +421 51 7480 465, 7480 464  
Fax: +421 51 7480 466  
www.regada.sk

75 0359 03

**2-way and 3-way solenoid valves direct acting Normally closed (NC)**

**Application**

Two-way (2/2) and three-way (3/2) solenoid valves direct acting can be used for flow control of water, air and other non-aggressive medium suitable for applied materials. Valves are closed at the basic position without voltage. After bringing of voltage to the coil the valve is open.

**2-way solenoid valves - technical data according TP 75 0357/03**

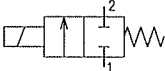

Type	Connection	Diameter DN [mm]	Operating pressure [MPa]		Voltage / Power consumption	Flow factor Kv [m <sup>3</sup> h <sup>-1</sup> ]	Medium temperature [°C]	Ambient temperature [°C]	Weight [kg]
			min.	max.					
2SVE1,2M	flange	1,2	0	1,2	AC / 9,4 VA DC / 6 W	0,04	max. 90	-10 ÷ +50	0,09
2SVE1,6M		1,6		0,8	AC / 9,4 VA DC / 6 W	0,07			
2SVE2M		2		0,6	AC / 9,4 VA DC / 6 W	0,1			
2SVE2,5M		2,5		0,4	AC / 9,4 VA DC / 6 W	0,12			

**3-way solenoid valves - technical data according TP 75 0357/03**

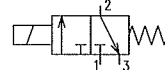

Type	Connection	Diameter DN [mm]	Operating pressure [MPa]		Voltage / Power consumption	Flow factor Kv [m <sup>3</sup> h <sup>-1</sup> ]	Medium temperature [°C]	Ambient temperature [°C]	Weight [kg]
			min.	max.					
3SVE1,2M	flange	1,2	0	1,2	AC / 9,4 VA DC / 6 W	0,04	max. 90	-10 ÷ +50	0,09
3SVE1,6M		1,6		0,8		0,07			
3SVE2M		2		0,6		0,10			

**Applied materials**

Body.....brass  
 Internal parts .....stainless steel, brass  
 Seals.....NBR ( operator - FPM ( Viton ) )  
 Coil .....thermal class F

**Ports**

- 1 - Inlet
- 2 - Outlet
- 3 - Exhaust

**Valve cut :**

Type 2SVExM

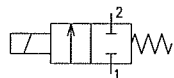

Type 3SVExM

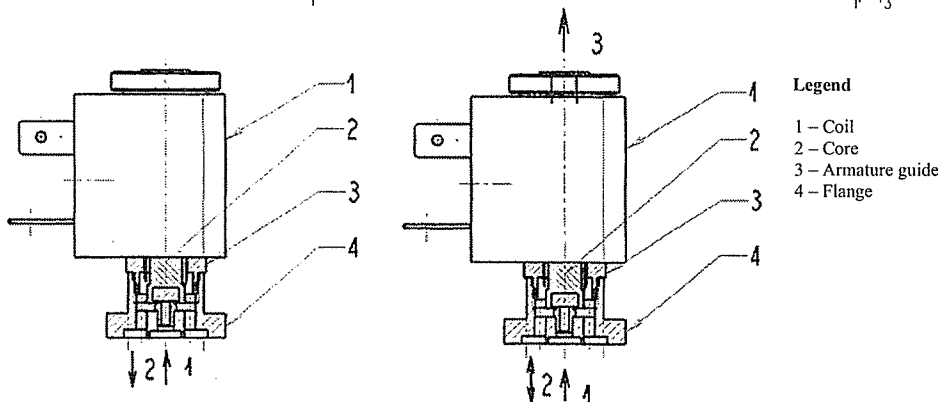
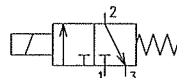

**Measurements flange valve :**

Type 2SVExM

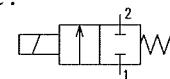

Type 3SVExM

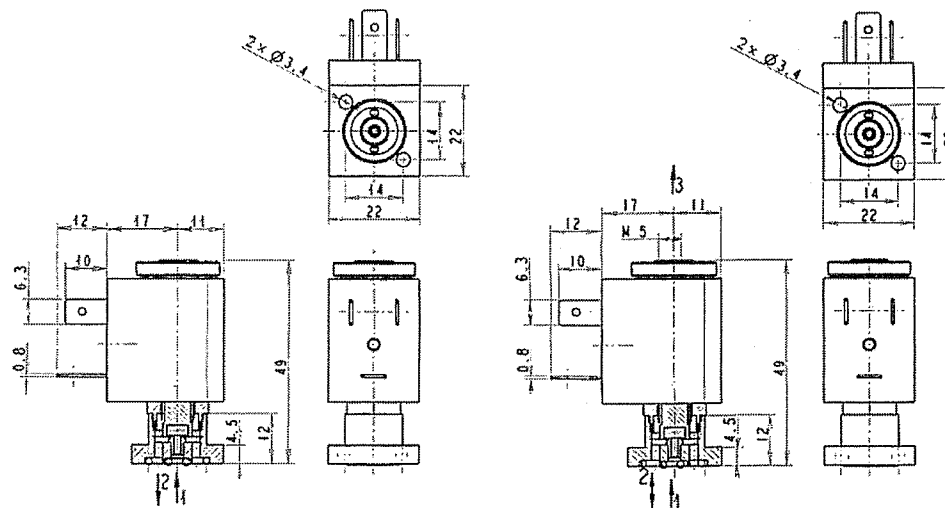
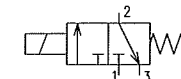

Clean thoroughly pipeline system before valve installing. Dirt causes malfunction. Necessary fit filter with 0, 2 mm filtration softness of valve inlet. The valve will not open or close if the control ducts or the armature are blocked by dirt. Electromagnet may not be used to capture the torque when fitting into the pipe. Operating position of valve is optional. Preferentially recommended is mounting with coil over the body to horizontal pipeline.

2-way solenoid valves – controlled medium has to flow through in direction of arrow as marked on the body. Valve is running correctly only in marked flow direction.

3-way solenoid valves – controlled medium is connected to inlet marked as 1. Output 2 is connected to controlled element. Exhaust 3 is connected to the waste, or serves directly as a blow off to the atmosphere. It is possible to assembly silencer to exhaust for reducing the noise of blown off air, which provides although protection against impurities penetration from ambient surroundings to the valve. The valve has in bottom body part two threaded openings M3 ( M4 ) for potential assembly to the equipment.

**Electrical connection**

Connect the coil in accordance with National electrical Engineering Standards. Before coil connection check electric data on coil and mains voltage. Voltage is connected to terminals marked on terminal board. Protective conductor must by safely connected to protective terminal, which is marked on the terminal board. The electrical cable must by effectively sealed in a plug. Electric connector plug provides protection for coil IP 65.

Coil is mounted to valve rotated in 360°. The plug can be positioned on the coil by 2 x 180°. Voltage can be connected to the coil only when assembled on the valve, the coil for alternating power can be damaged during connection, if is not slipped on the core guide !!!!!

**Instruction for operation**

Operating conditions should correspond with valve technical data. Temperature and medium type should correspond with seals and material of valve. By valve running is it necessary to check function rightness, seals and joints tightness.

Frozen medium causes a damage of valve and coil. Valves are not frost-proof. In case that medium freezes valve shall not be switch on because of possibility to coil damage.