

# **1760**

Power Quality Recorder

Users Manual

## **LIMITED WARRANTY AND LIMITATION OF LIABILITY**

Each Fluke product is warranted to be free from defects in material and workmanship under normal use and service. The warranty period is two years and begins on the date of shipment. Parts, product repairs, and services are warranted for 90 days. This warranty extends only to the original buyer or end-user customer of a Fluke authorized reseller, and does not apply to fuses, disposable batteries, or to any product which, in Fluke's opinion, has been misused, altered, neglected, contaminated, or damaged by accident or abnormal conditions of operation or handling. Fluke warrants that software will operate substantially in accordance with its functional specifications for 90 days and that it has been properly recorded on non-defective media. Fluke does not warrant that software will be error free or operate without interruption.

Fluke authorized resellers shall extend this warranty on new and unused products to end-user customers only but have no authority to extend a greater or different warranty on behalf of Fluke. Warranty support is available only if product is purchased through a Fluke authorized sales outlet or Buyer has paid the applicable international price. Fluke reserves the right to invoice Buyer for importation costs of repair/replacement parts when product purchased in one country is submitted for repair in another country.

Fluke's warranty obligation is limited, at Fluke's option, to refund of the purchase price, free of charge repair, or replacement of a defective product which is returned to a Fluke authorized service center within the warranty period.

To obtain warranty service, contact your nearest Fluke authorized service center to obtain return authorization information, then send the product to that service center, with a description of the difficulty, postage and insurance prepaid (FOB Destination). Fluke assumes no risk for damage in transit. Following warranty repair, the product will be returned to Buyer, transportation prepaid (FOB Destination). If Fluke determines that failure was caused by neglect, misuse, contamination, alteration, accident, or abnormal condition of operation or handling, including overvoltage failures caused by use outside the product's specified rating, or normal wear and tear of mechanical components, Fluke will provide an estimate of repair costs and obtain authorization before commencing the work. Following repair, the product will be returned to the Buyer transportation prepaid and the Buyer will be billed for the repair and return transportation charges (FOB Shipping Point).

THIS WARRANTY IS BUYER'S SOLE AND EXCLUSIVE REMEDY AND IS IN LIEU OF ALL OTHER WARRANTIES, EXPRESS OR IMPLIED, INCLUDING BUT NOT LIMITED TO ANY IMPLIED WARRANTY OF MERCHANTABILITY OR FITNESS FOR A PARTICULAR PURPOSE. FLUKE SHALL NOT BE LIABLE FOR ANY SPECIAL, INDIRECT, INCIDENTAL OR CONSEQUENTIAL DAMAGES OR LOSSES, INCLUDING LOSS OF DATA, ARISING FROM ANY CAUSE OR THEORY.

Since some countries or states do not allow limitation of the term of an implied warranty, or exclusion or limitation of incidental or consequential damages, the limitations and exclusions of this warranty may not apply to every buyer. If any provision of this Warranty is held invalid or unenforceable by a court or other decision-maker of competent jurisdiction, such holding will not affect the validity or enforceability of any other provision.

# Table of Contents

Chapter	Title	Page
<b>1</b>	<b>Introduction .....</b>	<b>1-1</b>
	About this Manual.....	1-3
	Symbols.....	1-3
	CAT Identification .....	1-4
	Safety Instructions.....	1-4
	Safety Instructions on Device Housing.....	1-7
	Mains Connection.....	1-7
	Input Voltage – Measuring Inputs.....	1-8
	Servicing and Maintenance .....	1-8
	Design and Functions.....	1-8
	Mains Connection and Interfaces.....	1-8
	Functional Description .....	1-10
	Basic Measurements .....	1-18
	Measurement Types.....	1-18
	Measurements.....	1-19
<b>2</b>	<b>Getting Started .....</b>	<b>2-1</b>
	Delivered Items .....	2-3
	Setup.....	2-4
	Installation .....	2-4
	Switching the Device On .....	2-4
	Switching the Device Off .....	2-4
	Simple Measurement - Function Check .....	2-4
	Transport and Storage .....	2-9
	Transport.....	2-9
	Storage.....	2-9
<b>3</b>	<b>Operation .....</b>	<b>3-1</b>
	Connections to Measuring Circuits.....	3-3
	Connecting Sequence .....	3-3
	Connection Diagrams .....	3-4
	1-Phase Measurement .....	3-4
	3-Wire Network with Two Current Sensors (ARON2 Method).....	3-5
	3-Wire Network with Two Current Sensors (ARON2 Method, Open Delta Method) .....	3-7

	4-Wire Network: 3-Wattmeter Method .....	3-8
	Four-Wire Network: Three-Wattmeter Method with N Conductor Voltage and N Conductor Current .....	3-9
	Two Star-Connected Voltage Systems .....	3-11
	Two Voltage Systems in Delta Configuration .....	3-12
	Methods of Measurement/Formulas .....	3-13
	Parameter Aggregation .....	3-13
	Calculation of Power Parameters .....	3-14
	Aggregations 200 ms and higher .....	3-14
	Real power .....	3-14
	Apparent power .....	3-15
	Reactive power .....	3-15
	Power factor .....	3-16
	Displacement power factor $\cos \varphi$ .....	3-16
	Half and full cycle aggregations .....	3-17
	Real power .....	3-17
	Apparent power .....	3-18
	Reactive power .....	3-18
	Power factor .....	3-18
	Events and Flicker .....	3-18
	Harmonics and Interharmonics Parameters .....	3-19
	Signaling Voltage .....	3-22
	Unbalance, Overdeviation, Underdeviation .....	3-22
	Current Unbalance .....	3-23
	Overdeviation and Underdeviation .....	3-24
<b>4</b>	<b>Maintenance .....</b>	<b>4-1</b>
	Introduction .....	4-3
	Maintenance of Battery Package .....	4-3
	Cleaning .....	4-3
	Replacement of Battery Pack .....	4-4
	Decommissioning and Disposal .....	4-4
	Shutting Down .....	4-4
	Recycling and Disposal .....	4-5
	Warranty .....	4-5
	Recalibration .....	4-5
<b>5</b>	<b>Specifications .....</b>	<b>5-1</b>
	General Specifications .....	5-3
<b>6</b>	<b>Options and Accessories .....</b>	<b>6-1</b>
	Instruments .....	6-3
	Accessories .....	6-3
	Standard Voltage Probes for AC and DC .....	6-4
	Flexible Current Probes for AC .....	6-5
	Current Probes for AC Currents .....	6-5
	Shunt Resistors for AC and DC Currents .....	6-6
	Other Accessories .....	6-6
	Current Clamp 1 A/10 A AC .....	6-6
	Current Clamp 5 A/50 A AC .....	6-10
	Current Clamp 20 A/200 A AC .....	6-14
	Flexi Current Sensor 100 A/500 A .....	6-17
	Flexi Current Sensor 200 A/1000 A .....	6-21

Flexi Current Sensor 3000 A/6000 A.....	6-24
GPS-Time Synchronization Module Option.....	6-27



# ***List of Tables***

<b>Table</b>	<b>Title</b>	<b>Page</b>
1-1.	Symbols.....	1-3
1-2.	Controls and Indicators .....	1-9
3-1.	Symbols in the Connection Diagrams .....	3-4
3-2.	Parameter Aggregation Matrix .....	3-25





# **List of Figures**

<b>Figure</b>	<b>Title</b>	<b>Page</b>
1-1.	CAT .....	1-4
1-2.	Instrument Labels .....	1-7
1-3.	Top View .....	1-8
1-4.	Front View .....	1-9
2-1.	Communication Cables .....	2-3
3-1.	Circuit Diagram: 1-Phase Measurement .....	3-4
3-2.	Circuit Diagram: 3-Wire Network (Aron 2) .....	3-6
3-3.	Circuit Diagram: Aron 2 Method/Open Delta Method .....	3-7
3-4.	Circuit Diagram: 4-Wire Network (Wye Connection) .....	3-8
3-5.	Circuit Diagram: 4-Wire .....	3-10
3-6.	Circuit Diagram: 2 Voltage System with Neutral .....	3-11
3-7.	Circuit Diagram: 2 Voltage System in Delta Connection .....	3-12



# **Chapter 1**

## **Introduction**

<b>Title</b>	<b>Page</b>
About this Manual .....	1-3
Symbols .....	1-3
CAT Identification .....	1-4
Safety Instructions .....	1-4
Safety Instructions on Device Housing.....	1-7
Mains Connection.....	1-7
Input Voltage – Measuring Inputs.....	1-8
Servicing and Maintenance .....	1-8
Design and Functions.....	1-8
Mains Connection and Interfaces .....	1-8
Functional Description .....	1-10
Basic Measurements .....	1-18
Measurement Types.....	1-18
Measurements.....	1-19



## About this Manual











This manual consists of several chapters.

- Introduction
- Getting Started
- Operation
- Maintenance
- Specifications
- Options and Accessories

## Symbols

Table 1-1 shows the symbols used on the instrument and/or in this manual.

**Table 1-1. Symbols**

Symbol	Description
	Hazardous voltage. Risk of electric shock.
	Important information. See manual.
	Do not apply around or remove from HAZARDOUS LIVE conductors.
	Earth ground.
	Double insulation.
	AC (Alternating Current)
	DC (Direct Current).
	Conforms to requirements of European Union.
	Canadian Standards Association is the certified body used for testing compliance to safety standards.
	Do not dispose of this product as unsorted municipal waste. Go to Fluke's website for recycling information.
	Conforms to relevant Australian Standards.
<b>CAT II</b>	IEC Overvoltage Category/Measurement Category II equipment is designed to be protected against transients from socket outlets and similar points.
<b>CAT III</b>	IEC Overvoltage Category III equipment is designed to protect against transients in installations, such as distribution panels, feeders and short branch circuits, and lighting systems in large buildings.
<b>CAT IV</b>	IEC Overvoltage Category IV equipment is designed to protect against transients from the primary supply level, such as an electricity meter or an overhead or underground utility service.

## CAT Identification

Figure 1-1 shows an example to identify the locations of different measurement categories (CAT).

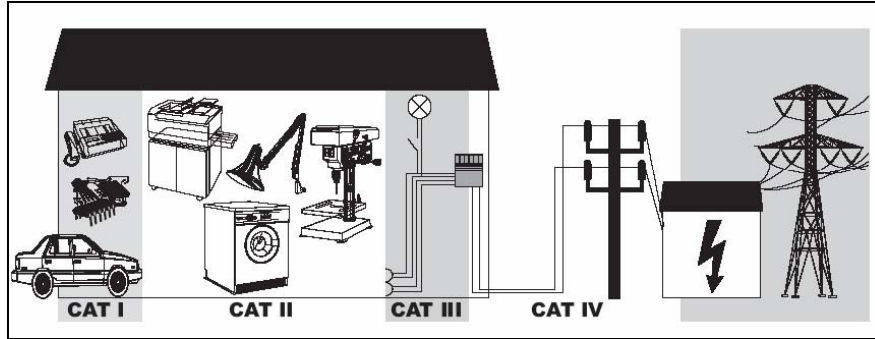

1\_1.bmp

Figure 1-1. CAT

## Safety Instructions

The design and manufacture of the device conform to the latest state of technology and the safety standards laid down in EN/IEC 61010-1:2001 (2<sup>nd</sup> ed.). If used improperly, there is a risk of injury to persons and damage of property.

Please read this section carefully. It will familiarize you with important safety instructions for handling your 1760 Power Quality Recorder. In this manual a **Warning** identifies conditions and actions that pose hazard(s) to the user. A **Caution** identifies conditions and actions that may damage the Recorder.

### Note

*The 1760 Power Quality Recorder is referred to as 'Recorder' throughout the manual.*

### Warnings

To avoid electric shock or personal injury:

- **The Power Quality Recorder must only be used and handled by qualified personnel.**
- **Maintenance work must be done only by qualified service personnel.**
- **Use only specified voltage and current probes. If you use flexible current probes, wear suitable protective gloves or work on de-energized conductors.**
- **Protect the Recorder against wetness and humidity.**
- **Do not hold the Current Clamp anywhere beyond the tactile barrier.**
- **To prevent electrical shock, always connect current probe test leads to the Recorder before connecting to the load.**

- To avoid electrical shock, do not connect the voltage measuring or power supply input to systems with higher voltages to ground (earth) than is marked on the Recorder.
- To avoid damage to the Recorder, never connect the voltage measuring inputs to phase-to-phase voltages higher than defined on the voltage sensors.
- To avoid damage to the Recorder, never connect the power supply voltage inputs to phase-to-phase voltages.
- Use only the provided original or specified accessories.
- Use these accessories only in the specified overvoltage category areas.
- Current transformers should not be applied or removed from HAZARDOUS LIVE conductors without using high-voltage gloves.
- Flexi-probes should not be applied to or removed from hazardous live conductors.
- Use the clamps only on insulated conductors, max. 600 V rms or dc to ground.
- The power company side of the revenue power meter is considered a CAT IV area. To avoid electrical shock or damage to the equipment, never supply the Recorder from the power in this area.
- Additional personal protective measures as required by local government agencies must be taken if the measuring sensors are installed on live conductors.
- Avoid connection from multiple channels to the same phase.

### **Protection Class**

This device is assigned to protection class I according to IEC 61140 and is equipped with a protective earth connector.

### **Qualified Personnel**

The device may only be operated by suitably qualified personnel. The adequate qualifications required are:

- Trained and authorized to switch on/off, ground (earth) and mark the power distribution circuits and devices in accordance with the safety standards of electrical engineering
- Training or instruction in accordance with the standards of the safety engineering in maintenance and use of appropriate safety equipment
- Training in first aid

### **Safe Operation**

For safe operation of the Recorder:

- Ensure that all persons using the device have read and fully understood the operating manual and safety instructions.

- The device may only be used under certain ambient conditions. Ensure that the actual ambient conditions conform to the admissible conditions laid down in Chapter 5, *General Specifications*.
- During the operation, ensure that the circulation of air around the instrument is possible in order to prevent the accumulation of heat inside the housing.
- Always comply with the instructions in Chapter 2, *Transport and Storage*.

### **Proper Usage**

Do not use the device for any other purpose other than measuring of voltages and currents that are within the measuring ranges and categories, including voltage to earth as laid down in Chapter 5, *General Specifications*.

Improper use shall void all warranty.

### **Electrical Connections**

- Ensure that the power and connecting cables used with the device are in proper working order.
- Ensure that the protective earth connector of the power lead and the housing earth connector are connected according to the instructions to the low-resistance unit earth cable.
- Ensure that the power and connecting cables as well as all accessories used in conjunction with the device are in proper working order and clean.
- Install the device in such a way that its power cable is accessible at all times and can easily be disconnected. If this is not applicable a two pole circuit breaker with a nominal current must be installed in the power supply lines.

### **Risks During Operation**

For connection work, do not work on your own but in teams of at least two persons.

Do not use the device if the housing or an operating element is damaged.

Ensure that the connected devices work properly.

Measurement sensors must not be connected to unfused circuits.

Connectors with locking mechanism have to be locked firmly.

### **Maintenance and Repairs**

Do not open the housing.

Do not carry out any repairs and replace any component parts of the device other than the replaceable battery.

Damaged connecting and power leads must be repaired or replaced by an authorized service technician.

Authorized, specialized technicians may only repair damaged or defective devices.

### **Accessories**

Only use the accessories supplied with the device or specifically available as optional equipment for your model.

Ensure that any third-party accessories used in conjunction with the device conform to IEC 61010-031/-2-032 standard and are suitable for respective measuring voltage range.



**Device Shutdown**

If you detect any damage to the housing, controls, power cable, connecting leads or connected devices, immediately disconnect the measuring inputs of the unit and then from the power supply.

If you are in doubt as regards the safe operation of the device, immediately shutdown the unit and the respective accessories, secure them against inadvertent switching on and bring them to an authorized service agent.

**Safety Instructions on Device Housing**

**Mains Connection**

The mains connection must conform to the ranges/values as inscribed on the instrument labels.

Figure 1-2 shows the instrument labels.

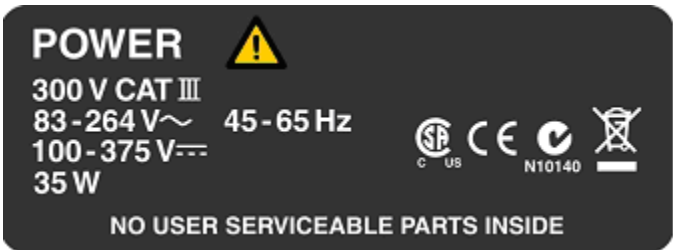

schild-mains.wmf



schild-akku.wmf

**Figure 1-2. Instrument Labels**

**⚠ ⚠ Warning**

**Risk of voltage peaks in higher categories. Connect the supply cable of the device only to sections CAT I, II or III of the supply system (Refer to the 'Functional Description' section) the voltage to earth may not exceed 300 V.**

**Input Voltage – Measuring Inputs**

The measurement category (refer to *Functional Description* section) and the max. voltage to earth of the sensors has to conform to the power supply system (See the inscription and the technical specifications of the accessories).

**Servicing and Maintenance**

- Do not remove the cover
- Refer servicing to qualified personnel
- The user can replace the accumulator package (Refer to Chapter 4, *Maintenance*)

**Design and Functions**

This section provides an overview of the terminals, ports and interfaces of the Recorder, as well as a list of displays and operating devices and a brief introduction to the basic functions of the unit.

**Mains Connection and Interfaces**

Figure 1-3 and Figure 1-4 show the top view and front view of the Recorder respectively.

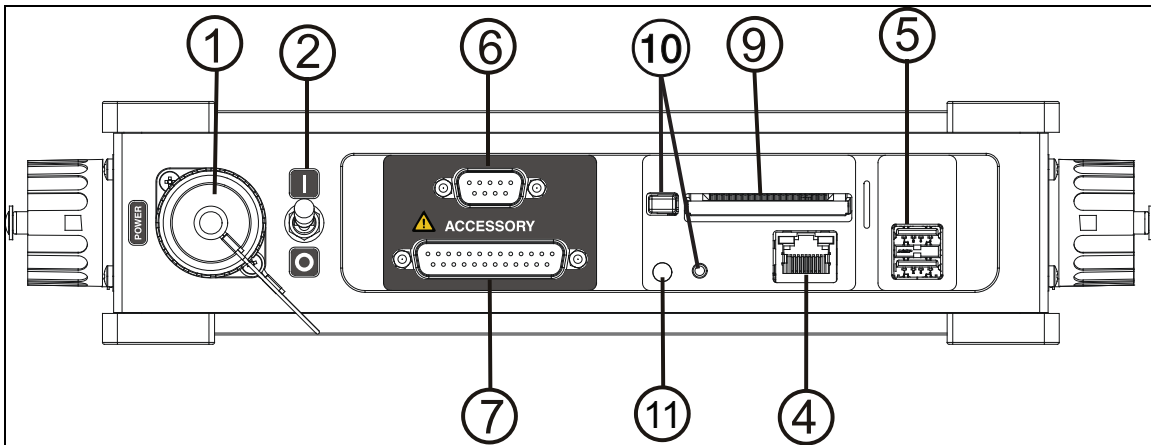

Figure 1-3. Top View

grafikview.eps

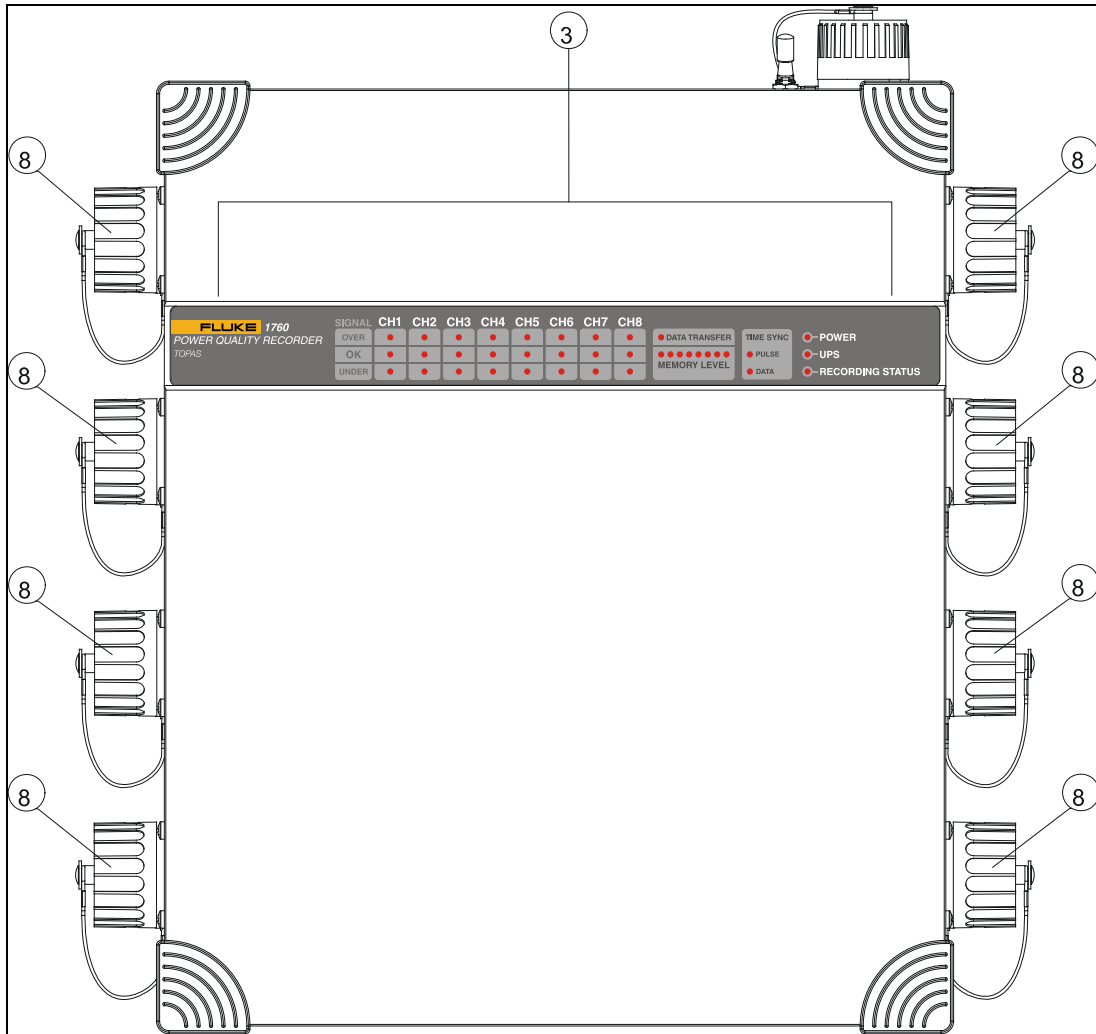

Figure 1-4. Front View

grafikview2.eps

Table 1-2 shows the controls and indicators of the Recorder.

Table 1-2. Controls and Indicators

SI No.	Description
①	Mains connection.
②	Mains switch.
③	LED indicators.
④	Ethernet connector
⑤	USB connectors type A.
⑥	COM1 – serial port (RS232).
⑦	Feature connector (GPS, DCF 77, COM2, alarms, etc).
⑧	Measurement input connectors.
⑨	Compact Flash card slot.
⑩	Compact Flash eject button and LED
⑪	Reset button.

*Note*

Channels 'CH1' to 'CH4' are labeled:



Schild CH1.wmf

The text *TRANSIENT* indicates that these channels can be equipped with a fast transient option.

Channels 'CH5' to 'CH8' cannot be used for fast transient recordings and are labeled like this:



schild ch5.wmf

## Functional Description

### ① Mains Connector

Connect the device to 83 V – 264 V AC-47 Hz – 65 Hz or 100 V – 375 V DC, power consumption approx. 30 W.

*Note*

Connect the supply cable of the device only to sections *CAT I, II or III* of the supply system the voltage to earth may not exceed 300 V.

### ② Mains Switch

Activate the mains switch to switch the device on or off.

*Note*

The switch is secured by a mechanical feature against inadvertent activation. Lift the knob slightly before moving it to the other position.

Instrument can be turned on only if the mains power supply is connected and the supply voltage is within the specified range.

If the mains switch is in position *I* the instrument is turned on automatically as soon as an appropriate supply voltage is applied to the mains connector.

If there is no mains supply and the battery pack capacity is too low the instrument is turned off automatically.

## Rebooting the Instrument

To reboot the instrument:

1. Set the mains switch to the 0-position.
2. Wait until all LEDs are off.
3. Connect instrument to mains and set the mains switch to the I-Position.

*Note*

*If the Reset button is held down while rebooting the instrument, the Recorder's stored data will be erased. This may be useful when the Recorder memory is full and may help to resolve connection problems.*

③ LED Indicators



LEDs in the field *Power*:

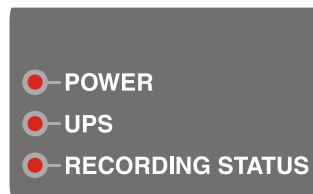

**Overview**

Condition	LED POWER	LED UPS
Instrument boot	Green	OFF
Mains is on, battery is not charged	Green	Green, yellow, or red according to capacity
Mains is on, battery is charged	Green	Slowly Flashing Green, yellow, or red according to capacity
Battery operation	OFF	Green, yellow, or red according to capacity
Battery discharge mode	OFF	Flashing Green, yellow, or red, Memory LEDs show "decreasing" yellow flashlight
Instrument shutdown	Green, flashing	Flashing Green, yellow, or red according to capacity
	Flashing alternately	

## Details

These LEDs provide information about the power supply:

### LED POWER:

- Continuously green: Instrument is supplied from mains
- OFF: Supply from battery package

### LED UPS:

Indicates charging state of the UPS battery package:

- *Green*: Battery is charged with 80 % to 100 % of nominal capacity
- *Yellow*: Capacity is between 30 % and 80 %, mains independent operation is possible for more than 3 minutes
- *Red*: Capacity is between 25 % and 30 % of nominal capacity. Mains independent operation is possible for less than 3 minutes
- *Flashing*: During charging the LED is flashing red, yellow, or green corresponding to charging state and turns to continuous green light when charging is complete

### LED RECORDING STATUS:

This indicator gives information about the recording status of the measurement campaign.

Condition	LED RECORDING STATUS
Instrument is not yet initialized for a measurement campaign	OFF
Measurement initialization is in progress, Instrument is not yet ready for recording data	green, flashing rapidly
Measurement campaign has been initialized, but not yet started	Green
Measurement campaign is active, data are recorded	Green, flashing slowly
Measurement campaign is active, data are recorded, but some memory portions are full, i. e. some virtual instruments do not record any more	Yellow, flashing slowly
Measurement campaign finished, no further campaign is programmed, data ready for upload to the PC, Instrument does not record data any more	Yellow
In case of error	Red

### LEDs Time Sync:

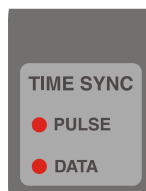

led-timesync.wmf

These indicators provide information about the time synchronization of the Instrument.

*LED PULSE:*

This LED indicates the reception of sync pulses. If Instrument is synchronized correctly the LED is green and flashes yellow for each pulse detected.

If external pulses are used without GPS time information the LED is off and flashes red for each detected sync pulse (to enable this, the “Pulse” protocol must be selected in the “Time Synchronization Configuration” in the PQ Analyze software).

*LED DATA:*

- *Green:* The Recorder is configured for time synchronization (Service menu), a time synchronization adaptor (GPS or DCF77) is connected, and the received time information is valid.
- *Yellow:* The Recorder is configured for time synchronization; a time synchronization adaptor is connected, but the received time information is not correct. Possible reasons: No satellites or time source found or adaptor still synchronizing after power on.
- *Red:* The Recorder is configured for time synchronization, but no time synchronization adaptor is connected or it is not working properly.
- *Off:* The recorder is not configured for time synchronization.

**LEDs for Data Transfer and Storage:**

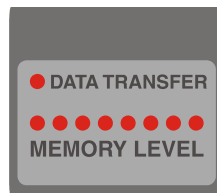

led-data.wmf

*LED DATA TRANSFER:*

The DATA TRANSFER LED indicates data transfer via external interfaces or to the Compact Flash card.

- *Off:* No connection between PQ Analyze software and Recorder exists.
- *Green:* Connection between PQ Analyze software and Recorder established.
- *Flashing yellow:* data are written to the internal CF-card, external CF-card, USB memory stick or data transfer via any of the interfaces (USB, RS232, or Ethernet)

*LEDs MEMORY LEVEL:*

The row of MEMORY LEVEL LEDs indicates the amount of free/occupied measurement data memory on the Compact Flash card.

Occupied blocks are indicated by lit LEDs, 5 on the left side are green, 3 on the right side are red to indicate that the memory is soon full.

During a forced battery discharge these LEDs are flashing yellow, the number of LEDs lit represents the remaining capacity in minutes.

**LEDs CH1 to CH8:**



led-kanäle.wmf

Three LEDs are assigned to each of the eight input channels of the Recorder. The indicators refer to half cycle or full cycle rms values of the input signal (depending on the configuration).

The following information is provided in case a valid sensor is detected.

Condition	LED UNDER	LED OK	LED OVER
Signal within nominal range	Off	Green	Off
Signal too low (dip)	Yellow	Off	Off
Signal too high (swell)	Off	Off	Yellow
Over range (ADC-overflow)	Off	Off	Flashing red
Phase sequence wrong	Off	LEDs blinking in sequence L3-L2-L1	Off

The following information is provided in case no valid sensor is detected:

Condition	LED UNDER	LED OK	LED OVER
Signal within nominal range	Off	Red	Off
Signal too low	Yellow	Red	Off
Signal too high	Off	Red	Yellow
Over range	Off	Red	Flashing red



*Note*

The LED OK is red if no valid sensor can be detected.

The limits for 'Signal too low' and 'Signal too high' are equal to the thresholds for voltage dips and voltage swells (e.g.  $\pm 10\%$  of  $U_n$ ).

For current inputs 'Signal too low' is indicated for half cycle or full cycle rms values below 10 % of the sensor range as configured in the "Hardware Settings" panel (if sensor is set to "Auto" the "Signal too low" indication is deactivated).

'Over range' is indicated if the input signal is outside the valid measurement range.

The phase voltages UL1, UL2, and UL3 of a three-phase system are monitored with the symmetrical components (zero, positive and negative system). If the negative system exceeds an upper threshold a wrong phase sequence condition is indicated (e.g. two lines interchanged); the associated LEDs are flashing in sequence L3-L2-L1.

 **Warning**

**The LEDs do not indicate whether there is voltage. Do not rely on the LEDs to find out whether the device under test is live or not.**

**④ Ethernet port**

Used for connection of the Recorder to an Ethernet port of a PC, or to an Ethernet network (LAN). For a connection to an Ethernet network use the supplied Ethernet cable. For direct connection of the instrument to a PC use the cross-linked Ethernet cable (with the red plug).

**⑤ 2 USB connectors**

The USB type A connectors for connection of a USB memory device, USB version V2.0 is supported.

USB connectors have the following function:

- USB stick support for storing of measurement data (same as external CF card).

CF card LED behaviour during USB copy process:

- copy process started --> flashing LED
- copy process finished and all data copied --> LED goes off
- copy process finished but not all data could be copied --> LED is turned on statically
- on error --> fast flashing LED for approx. 3 seconds then statically on

*Note*

*USB stick must not be pulled out while CF card LED is flashing. This can cause permanent damage to the storage media. Only remove CF card / USB stick while CF card LED is OFF or statically ON. Do not use CF card or data connection at the same time.*

**⑥ Serial port COM1 (RS232)**

Serial port for connection of the device to the serial port of a PC.

The default settings are 57.600 Baud, 8 data bits, 1 stop bit, no parity.

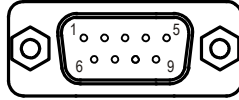

com\_stecker.wmf

**Pin assignment:**

Pin	Signal	Description
1	DCD	Data Carrier Detect
2	RxD	Receive Data
3	TxD	Transmit Data
4	DTR	Data Terminal Ready
5	GND	Ground
6	DSR	Data Set Ready
7	RTS	Request To Send
8	CTS	Clear To Send
9	RI	Ring Indicator

⑦ **Feature connector**

**Specification of outputs / inputs:**

Condition	Voltage level
Low (inactive)	0 - 0.8 V
High (active)	2.5 - 5 V

Maximum load current: 5 mA.

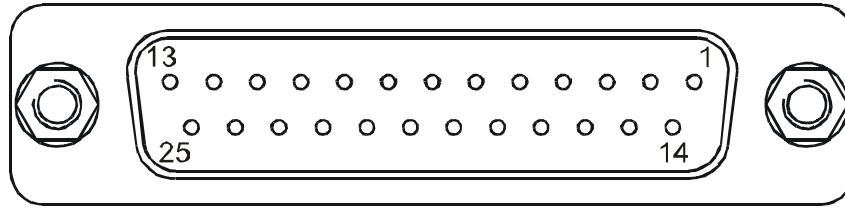

stecker lpt.wmf

**Pin assignment:**

Pin	Signal	Description
1	+15 V	Power supply voltage, max. 300 mA
2	TxD	Output, Transmit Data COM2
3	RxD	Input, Receive Data COM2
4	RTS	Output, Request to send COM2
5	CTS	Input, Clear to Send COM2
6	Service	Output, internal use
7	GND	Signal ground
8	Service	Output, internal use
9	Watchdog Pulse	Output, CPU watch dog signal
10	O1	Alarm output, reset with input RES 1
11	O2	Alarm output, reset with input RES 1
12	O3	Alarm output, reset with input RES 2
13	O4	Alarm output, reset with input RES 2
14	+5 V	Power supply voltage
15	GPS PPS+	Input for GPS time synchronization
16	GPS PPS –	Input for GPS time synchronization
17	GPS Transmit+	Input for GPS time synchronization
18	GPS Transmit-	Input for GPS time synchronization
19-23	Service	Output, internal use
24	RES1	Reset input for alarm outputs O1, O2
25	RES2	Reset input for alarm outputs O3, O4

**⑧ Measurement Channels**

Plugs for 8 isolated measurement channels. Connect only original accessories such as voltage and current sensors (clamps, Flexi Set, shunt resistors, etc.). The plug is secured by means of a bayonet mechanism.

*Note*

*Inputs that are not in use must be covered with the supplied protective caps to prevent pollution.*

*When analyzing transients with 500 kHz transient option or 10 MHz transient option, the potential to earth/ground is measured.*

## ⑨ ⑩ Compact Flash Card

Replaceable Compact Flash card for storage of measurement data. ⑩ Compact Flash eject button and LED. Do not operate when data transfer is active (LED indicates activity).

CF card LED behaviour during CF copy process:

- CF card inserted and detected --> short flashing (double pulses)
- copy process started --> flashing LED
- copy process finished and all data copied --> LED goes off
- copy process finished but not all data could be copied --> LED is turned on statically
- on error --> fast flashing LED for approx. 3 seconds then statically on

### Notes

- *CF card must not be pulled out while CF card LED is flashing. This can cause permanent damage to the storage media. Only remove CF card / USB stick while CF card LED is OFF or statically ON. Do not use USB stick or data connection at the same time.*
- *Stored data can be erased by holding down the Reset Button ⑪ while switching on (booting) the instrument. This may be useful when the memory is full and may also resolve connectivity issues.*

## Basic Measurements

The Instrument offers all functions necessary to perform network analysis, quality assurance evaluations and location of disturbance sources. A large compact flash data memory provides a method of effecting long-term recordings. All data is saved even without connection of the instrument to an evaluation computer. No information will be lost. The recordings are the basis for detailed evaluations and analyze to assess disturbances and the mains voltage quality. The instrument records and provides historical event data, which protective relays or protective switches have induced and how the resources have performed.

### Measurement Types

The instrument combines many different measurement types, also referred to as “virtual instruments”:

- Digital recording of measured data (data logger)
- Power measuring device (recording of load profiles)
- Recording of power frequency
- Power Quality Analyzer (including statistical evaluation)
- Fast transient recorder (optional)
- Ripple control signal analyzer
- Harmonics analyzer
- Voltage disturbances analyzer (events)

## **Measurements**

The following measurements can be made:

- rms values of voltage and current as well as power values with programmable averaging time
- Oscilloscope data (instantaneous value, sensing value)
- Powerful and versatile triggering engine
- Load and energy measurements
- Analysis of voltage and current harmonics
- Analysis of voltage and current interharmonics
- Fast transient analysis
- Signaling voltage, ripple control signal analysis
- Mains voltage quality analysis as per EN 50160



## **Chapter 2**

# **Getting Started**

<b>Title</b>	<b>Page</b>
Delivered Items.....	2-3
Setup .....	2-4
Installation .....	2-4
Switching the Device On.....	2-4
Switching the Device Off.....	2-4
Simple Measurement - Function Check.....	2-4
Transport and Storage.....	2-9
Transport .....	2-9
Storage.....	2-9





## Delivered Items

Before commencing work with the device, check the delivery to ensure that it is complete, using the following list and the delivery specifications.

- 1 Power Quality Recorder Instrument
- 1 Getting Started manual
- CD-ROM with PQ Analyze application software, manuals, data sheets, and demo data
- 1 power cord for mains connection
- 1 main connection adapter set
- 1 crosslink RS232 connection cable
- 1 Ethernet cable for direct PC connection
- 1 Ethernet cable for network connection

Optional:

- 4 voltage sensors
- 4 Flexi current sensors
- Carrying bag
- GPS receiver module

Figure 2-1 shows the communication cables.

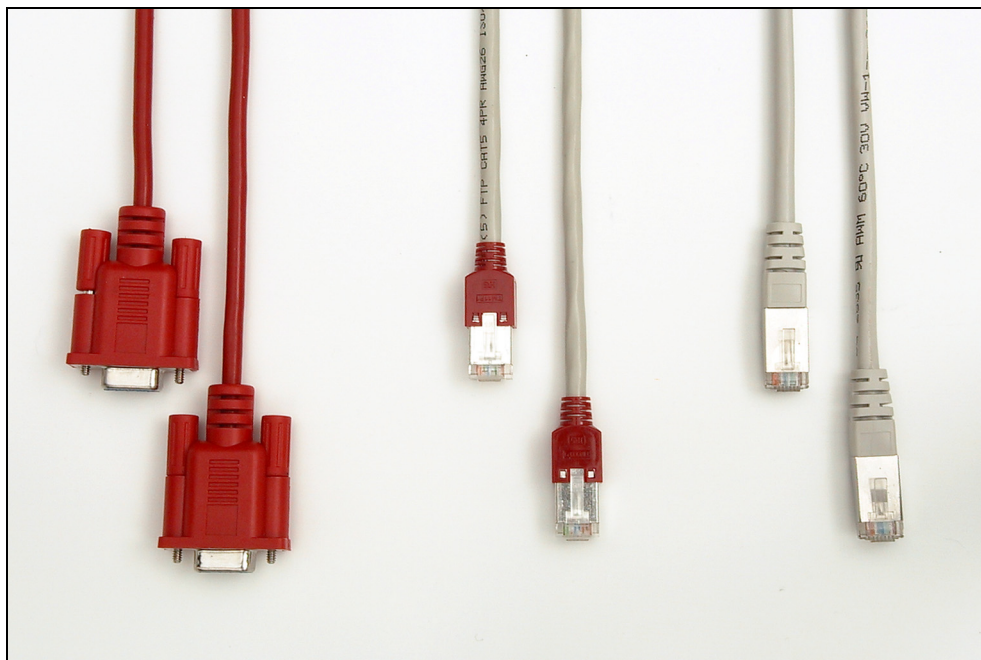

**Figure 2-1. Communication Cables**

ph\_interfacecables.bmp

## Setup

### Installation

Follow the safety instructions regarding the ambient conditions and location of the installation.

#### Warning

**First connect the device with the mains cable and compatible adapter to the power supply network. Observe the specifications on the device type plate.**

**The device is connected to mains power, and a number of internal components are live with dangerous voltage levels. To remain safe during the operation, the device must be equipped with a low-resistance connection to the earth. Therefore, check the mains socket and its wiring.**

**Connect the supply cable of the device only to the sections CAT I, II or III of the supply system. The voltage to earth may not exceed 300 V.**

### Switching the Device On

Switch on the power supply to the device (lift switching knob ② slightly and move to position 'I'). The LED POWER is lit. After approx. 40 seconds of booting, the device is ready for the operation.

### Switching the Device Off

Lift switching knob ② slightly and move to position '0'. The LED POWER goes off after closing all the internal data files.

#### *Note*

*The instrument can be only switched off after the boot process is finished (duration is approx. 40 seconds).*

## Simple Measurement - Function Check

The procedure below allows users to familiarize themselves with the measuring functions of the instrument, while testing all basic device functions.

Installation: Install the instruments SW PQ Analyze, see *Reference Manual PQ Analyze*.

Connect device: Connect instrument to mains and switch on.

Connect your computer and the recorder via the red Ethernet cable for direct connection. Wait for a short time (see the *1760 Reference Manual*, "Direct Peer to Peer Communication over Crossover Ethernet Cable").

Connect the device channels as described in the "*Connections to Measuring Circuits*".



2\_1.bmp

Communication: Start PQ Analyze

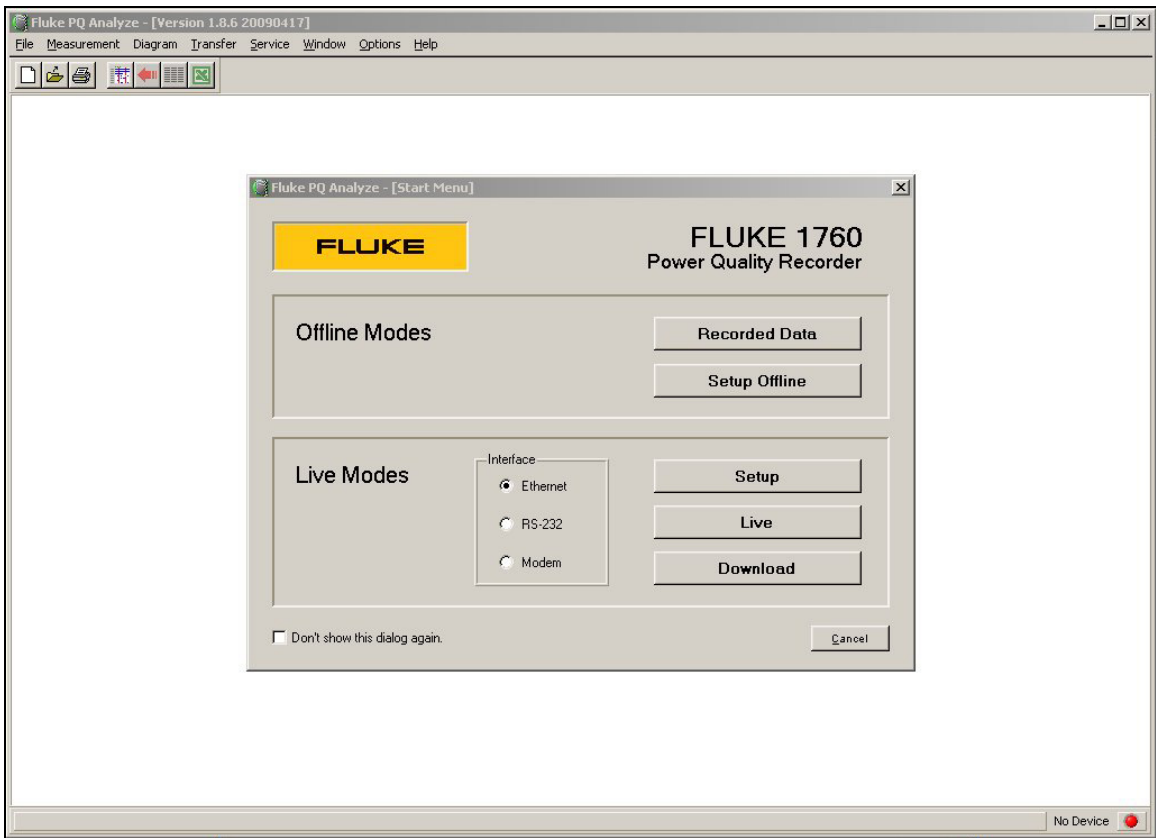

2\_2.bmp

In the “Live Modes” section press “Setup”.

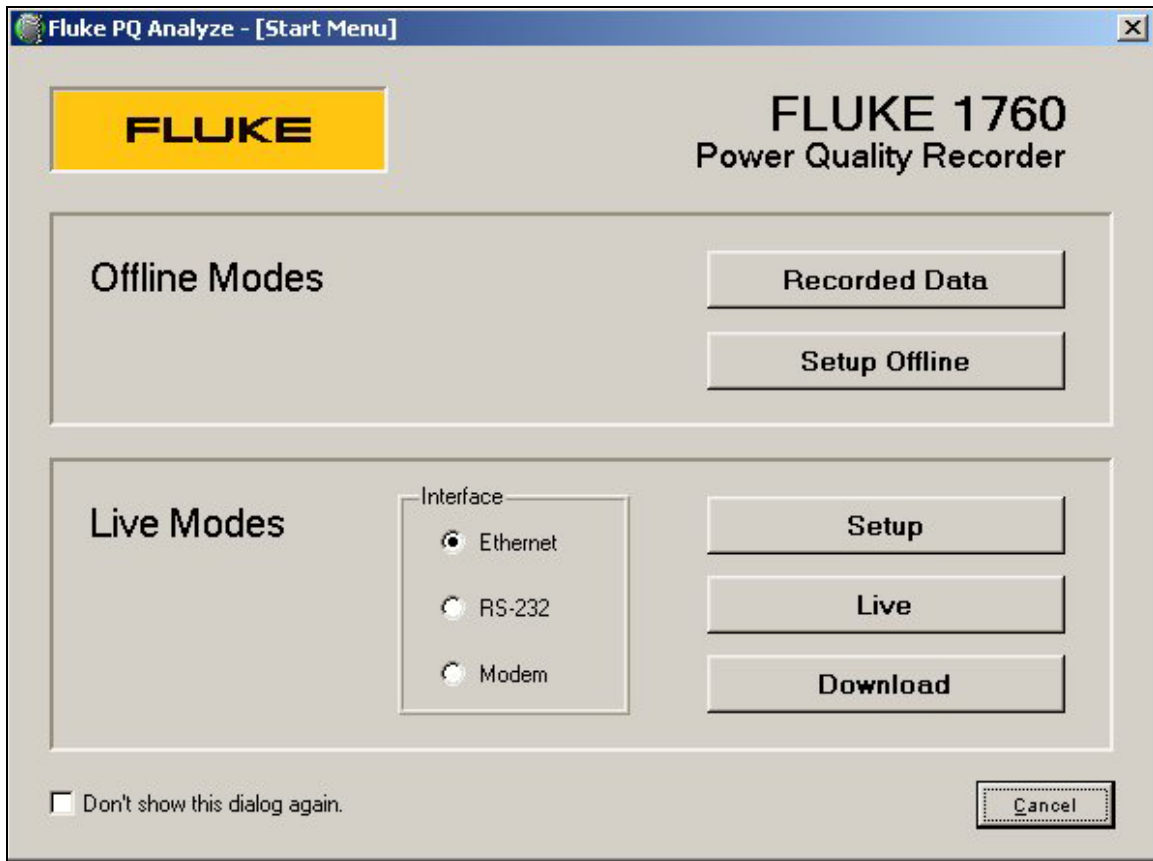

In the “Search Devices” dialog press “Search”.

Select your instrument in the list and press “Connect”.

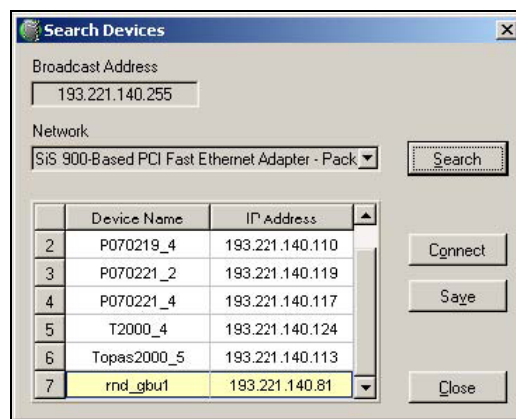

After successful connection, you see a green light in the lower right corner next to status information about the instrument.

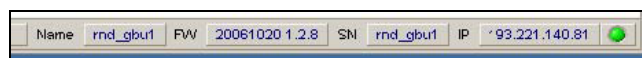

Initialization: The “Settings” window is the starting point for all measurement configurations. For now accept the default settings and press “Initialize”

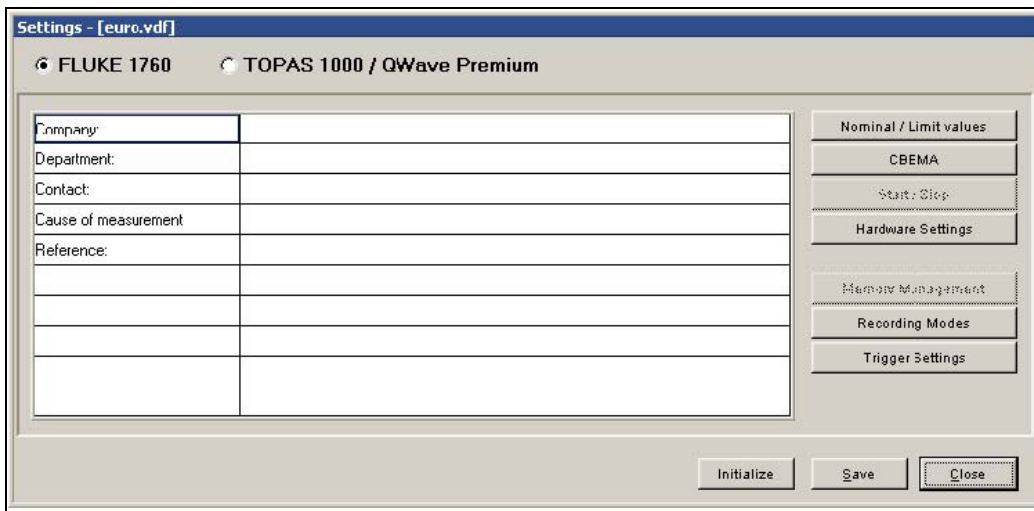

2\_6.bmp

Choose a name or accept the default one. Press OK.

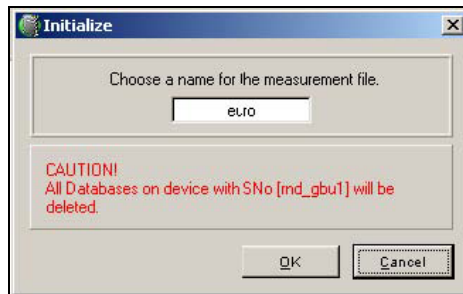

2\_7.bmp

Wait while measurement is initialized.

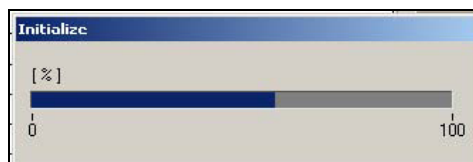

2\_8.bmp

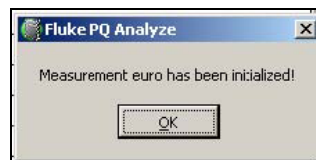

2\_9.bmp

Press “OK” and watch the “RECORDING STATUS” LED on the instrument. It should start flashing slowly indicating the active measurement.

Close the “Settings” window.

Measure: Select menu “Transfer > Live Mode”.  
Press “Oscilloscope”

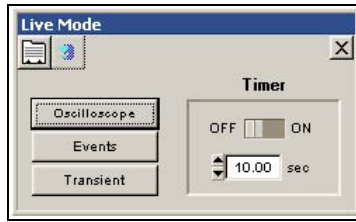

2\_10.bmp

Select all channels that you want to have displayed and press the “Timeplot” icon.

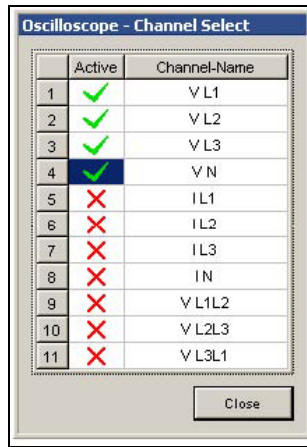

2\_11.bmp

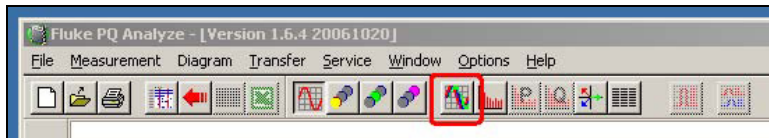

2\_12.bmp

If everything works correctly you will see an oscilloscope like recording of the signals supplied to the input channels. All connections and sensors are working properly.

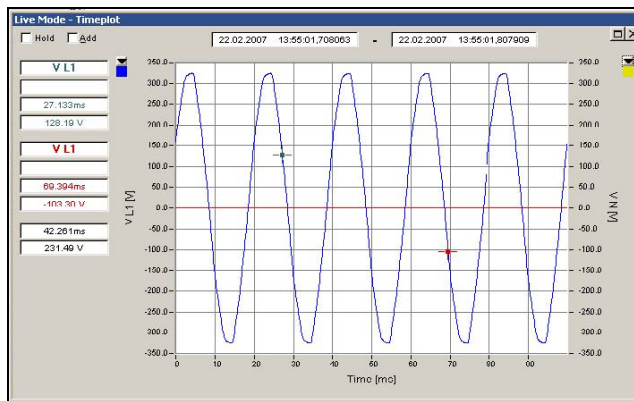

2\_13.bmp

For detailed instructions, refer to the *Reference Manual PQ Analyze*.

Next steps: For transferring the measured data from the device to the PC and for evaluating the data according to your requirements see *Reference Manual PQ Analyze*.

## **Transport and Storage**

### **Transport**

- Transport the device only in its original packaging
- Keep the operating manual supplied with the device for future reference
- Protect the device during the transport against heat and moisture. Do not exceed the temperature range of  $-20\text{ }^{\circ}\text{C}$  to  $+60\text{ }^{\circ}\text{C}$  and a maximum humidity of 85 %
- Protect the device against impacts and loads

### **Storage**

- Keep the original packaging, as it might be required at a later stage for transport purposes or to return the device for repairs. Only the original packaging guarantees the proper protection against mechanical impacts
- Store the device in a dry room; the temperature range of  $-20\text{ }^{\circ}\text{C}$  to  $+60\text{ }^{\circ}\text{C}$  and a maximum humidity of 85 % may not be exceeded  
Keep the operating manual supplied with the device for future reference
- Protect the device against direct sunlight, heat, moisture and mechanical impacts.





## **Chapter 3**

# **Operation**

<b>Title</b>	<b>Page</b>
Connections to Measuring Circuits.....	3-3
Connecting Sequence .....	3-3
Connection Diagrams .....	3-4
1-Phase Measurement .....	3-4
3-Wire Network with Two Current Sensors (ARON2 Method).....	3-5
3-Wire Network with Two Current Sensors (ARON2 Method, Open Delta Method).....	3-7
4-Wire Network: 3-Wattmeter Method.....	3-8
Four-Wire Network: Three-Wattmeter Method with N Conductor Voltage and N Conductor Current .....	3-9
Two Star-Connected Voltage Systems.....	3-11
Two Voltage Systems in Delta Configuration .....	3-12
Methods of Measurement/Formulas .....	3-13
Parameter Aggregation.....	3-13
Calculation of Power Parameters .....	3-14
Aggregations 200 ms and higher.....	3-14
Real power .....	3-14
Apparent power.....	3-15
Reactive power.....	3-15
Power factor .....	3-16
Displacement power factor $\cos \phi$ .....	3-16
Half and full cycle aggregations.....	3-17
Real power .....	3-17
Apparent power.....	3-18
Reactive power.....	3-18
Power factor .....	3-18
Events and Flicker .....	3-18
Harmonics and Interharmonics Parameters.....	3-19
Signaling Voltage .....	3-22
Unbalance, Overdeviation, Underdeviation .....	3-22
Current Unbalance .....	3-23
Overdeviation and Underdeviation .....	3-24



## Connections to Measuring Circuits

### Warning

By connecting the unit to circuits, the terminals and certain parts inside the device are live. Utilization of leads and accessories that do not fulfill the relevant safety standards could lead to serious injury or death from electric shock.

In order to ensure safe operation:

First connect the device to protective earth and to the power supply.

Open the circuit before establishing a connection to the device. Prior to connecting the circuits, ensure that the maximum measuring voltage and the max. voltage to earth do not exceed and the category of distribution system corresponds with the inscription of the sensor 'or' meet the country specific standard.

### Connecting Sequence



When connecting a circuit to Instrument, for safety reasons, proceed in the sequence outlined below:

1. Check the standard mains socket for a proper protective earth connection. Connect the instrument to the power supply socket. The PQ Recorder is now connected to the protective earth (Safety Class 1 equipment).
2. Connect the measuring circuit as shown in the connection diagrams.
3. Switch on the Recorder.
4. Ensure that the direction of the energy flow is correct (load flow direction).

### Connection Diagrams

The measuring circuit is selected by means of the *File > New / Hardware Settings* menu of the PQ Analyze software. Connect the sensors in load flow direction (observe arrows).

**Table 3-1. Symbols in the Connection Diagrams**

Symbol	Meaning
	Connect the Flexi current sensors in the right direction. The arrow on the Flexi must show from the network to the load.
	Red connector.
	Black connector.

*Note*

*Use channel 'CH4' as control channel for triggering on external signals.*

*Note*

*Fast voltage transients are always measured between the red plug of the voltage sensor and the device ground (earth, protective conductor).*

*Please, note that the voltage sensors with a rated range of >100 V are equipped with the fast transient function (if the transient option is installed).*

### 1-Phase Measurement

Figure 3-1 shows the circuit diagram for 1-phase measurement.

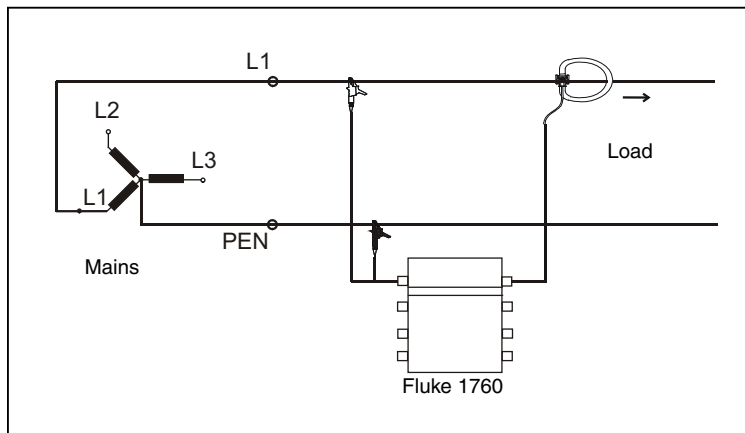

1wattm1.eps

**Figure 3-1. Circuit Diagram: 1-Phase Measurement**

**Associated PC software settings:**

Connection to Single-Phase 2-Wire Network:

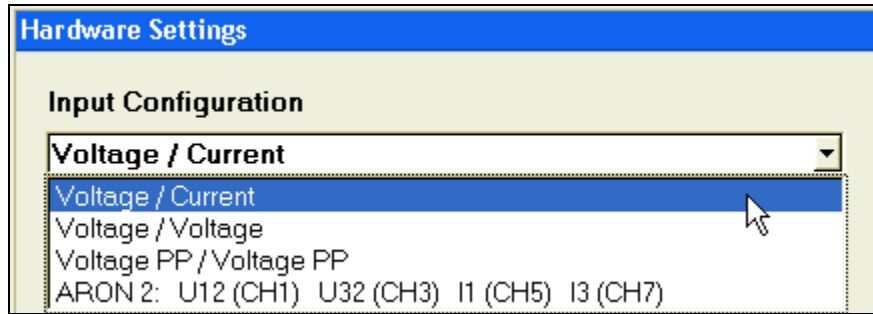

messsystem1 u-i-1.bmp

and

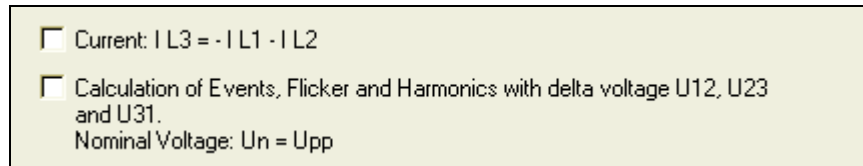

messsystem1 u-i-1.bmp

The option *Calculation of Events, Flicker, and Harmonics with delta voltage U12, U23 and U31* for the phase-to-phase voltages is not of relevance here.

*Note*

*All 8 channels are measured. Please keep this in mind when assessing the power quality according to EN 50160.*

*To avoid false triggering, please switch channels that are not connected to "OFF" in the "Hardware Settings" configuration panel.*

**3-Wire Network with Two Current Sensors (ARON2 Method)**

Conventional two-wattmeter method with current sensors on phases *L1* and *L3*.

The device calculates  $I_{L2} = -I_{L1} - I_{L3}$ . Two phase-to-phase voltages (*U12* *U32*) are measured. The third phase-to-phase voltage (*U23*) is calculated. The recorder then transforms this delta system into a virtual Wye system by calculating virtual phase voltages. This virtual Wye system is in turn used to calculate the power values of all three phases as well as the total power. This method is applicable only if  $I_1 + I_2 + I_3 = 0$ , i.e. if there is no neutral conductor.

Figure 3-2 shows the circuit diagram for 3-wire network (Aron 2).

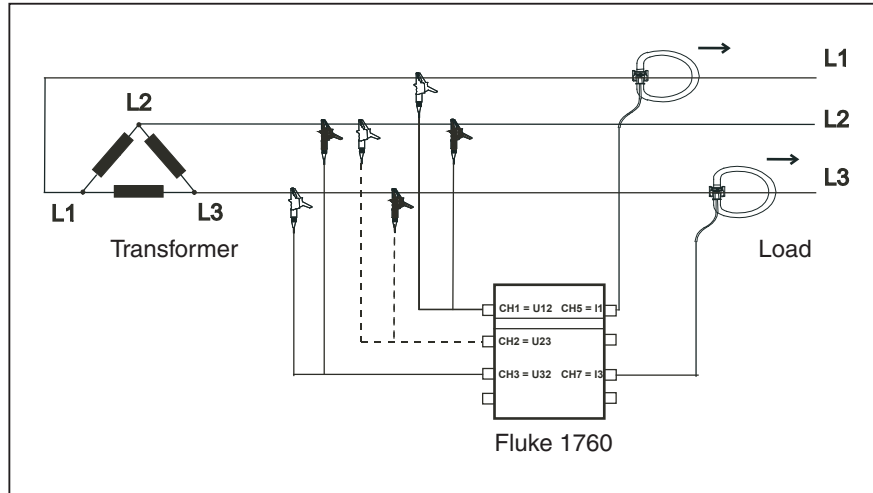

2wattm1-aron2.eps

Figure 3-2. Circuit Diagram: 3-Wire Network (Aron 2)

*Note*

The voltage sensor at channel CH2 denoted with dotted lines is only required for transient measurements; for current, voltage power measurements, no sensor is required at CH2.

**Associated Device Software Settings:**

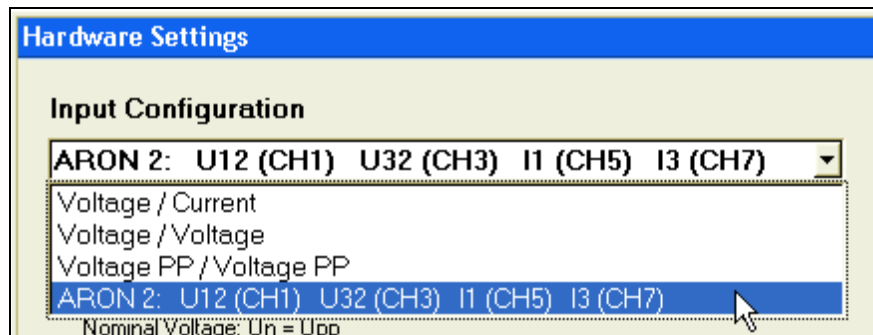

messsystem5 aron2.bmp

Check the respective option.

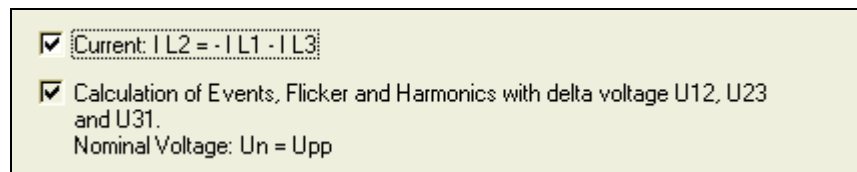

messsystem5 aron2-1.bmp

If the option  $IL2 = -IL1 - IL3$  is checked, the current  $IL2$  is calculated. If this option is not checked, the current  $IL2$  is measured by means of a sensor at phase L2 (Instrument channel CH6).

*Note*

The nominal voltage has to be entered as a phase-phase voltage in the dialogue Nominal-Limit values (i.e. 400 V in a 230 V P-N-system).

### 3-Wire Network with Two Current Sensors (ARON2 Method, Open Delta Method)

The conventional two-wattmeter method with current sensors at phases L1 and L3 is frequently used in the medium voltage networks with built-in current and voltage converters.

The device calculates  $I_{L2} = -I_{L1} - I_{L3}$ . Two phase-to-phase voltages (U12, U32) are measured. The third phase-to-phase voltage (U23) is calculated. The recorder then transforms this delta system into a virtual Wye system by calculating virtual phase voltages. This virtual Wye system is in turn used to calculate the power values of all three phases as well as the total power. This method is only applicable, if  $I_1 + I_2 + I_3 = 0$ , i.e. if there is no neutral conductor.

Figure 3-3 shows the circuit diagram for 3-wire network with 2 current sensors (Aron method), open delta method.

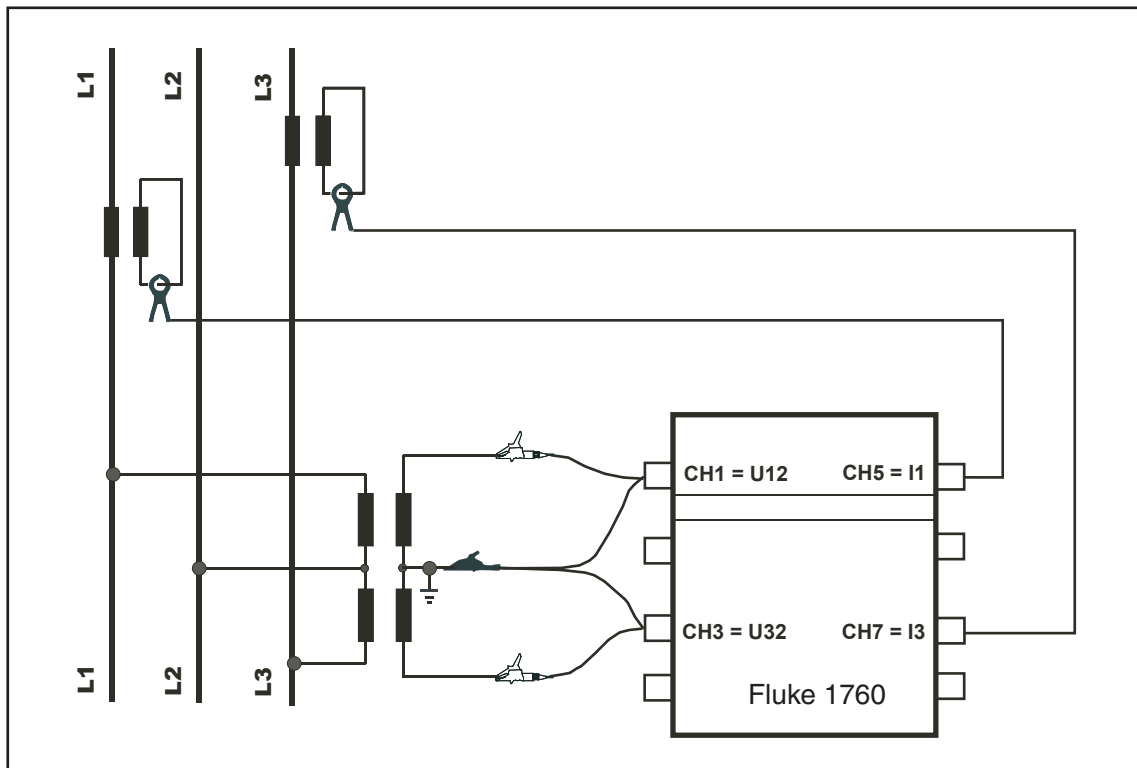
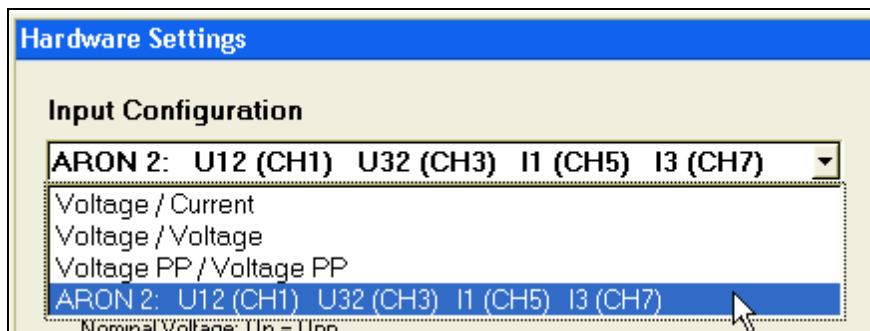

Figure 3-3. Circuit Diagram: Aron 2 Method/Open Delta Method

v-schaltung-3.eps

#### Associated PC Software Settings:



messsystem5 aron2.bmp

Check the respective option.

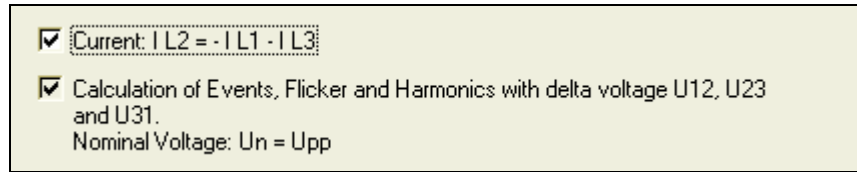

messsystem5 aron2-1.bmp

If option  $I_{L2} = -I_{L1} - I_{L3}$  is checked, the current  $I_{L2}$  is calculated. If this option is not checked, the current  $I_{L2}$  is measured by means of a sensor connected to phase L2 (Instrument channel CH6).

The option *Calculation of Events, Flicker, and Harmonics with delta voltage  $U_{12}$ ,  $U_{23}$  and  $U_{31}$*  is automatically on and cannot be deactivated.

*Note*

*The nominal voltage has to be entered as a phase-phase voltage in the dialogue Nominal-Limit values (i.e. 400 V in a 230 V P-N-system).*

*Enter the applicable transformation ratios for the current and voltage converters in the 'Hardware Settings' dialog.*

*As conventional current converters have an output current of 1 A or 5 A AC respectively at rated current, we recommend using current probes rather than flexible current sensors, as they provide better resolution and linearity at low currents.*

**4-Wire Network: 3-Wattmeter Method**

This is the standard measurement configuration for three-phase networks with 3 voltage and 3 current sensors.

Figure 3-4 shows the circuit diagram for 4-wire network (Wye connection).

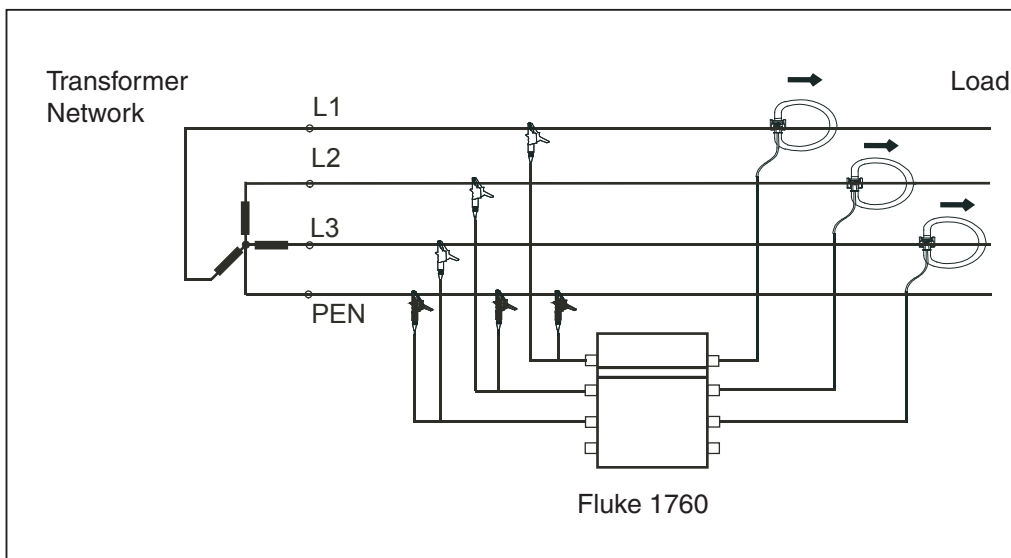

3wattm1.eps

**Figure 3-4. Circuit Diagram: 4-Wire Network (Wye Connection)**



**Associated PC Software Settings:**

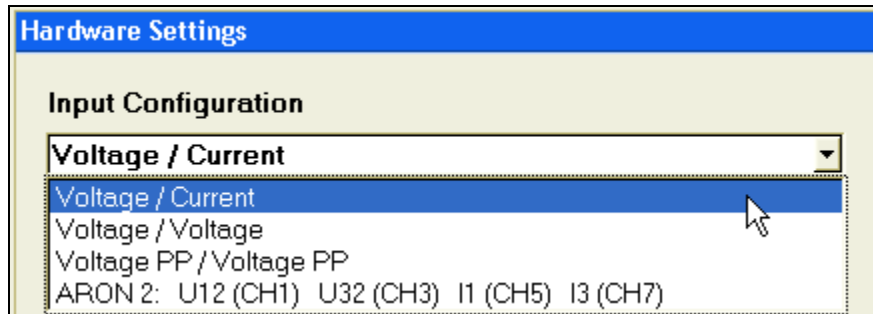

messsystem1 u-i.bmp

If required, you have the option to determine events, Flicker and Harmonics, of the phase-to-phase voltages.

Check the respective option.

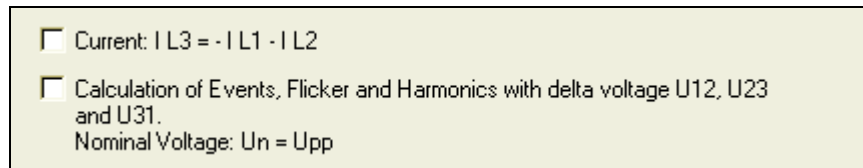

messsystem1 u-i-1.bmp

*Note*

*If this option (calculation) is checked, you must enter the phase-to-phase voltage as the rated voltage  $V_N$  in 'Settings – Nominal / Limit values' (e.g. 400 V in the 230 V P-N network).*

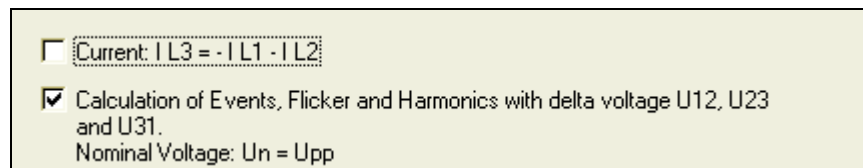

messsystem1 u-i-2.bmp

**Four-Wire Network: Three-Wattmeter Method with N Conductor Voltage and N Conductor Current**

This is the standard measurement configuration for three-phase networks with 4 voltage and 4 current sensors.

Figure 3-5 shows the circuit diagram for 4-wire network (3-wattmeter method) with N-conductor voltage and N-conductor current.

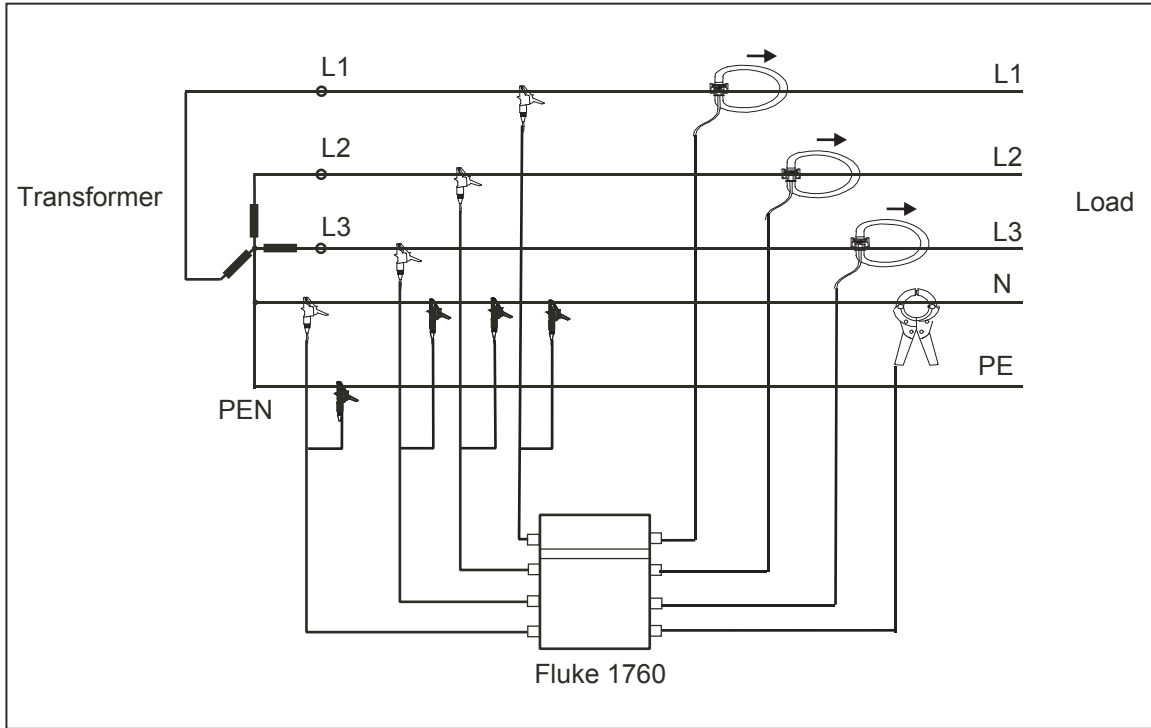
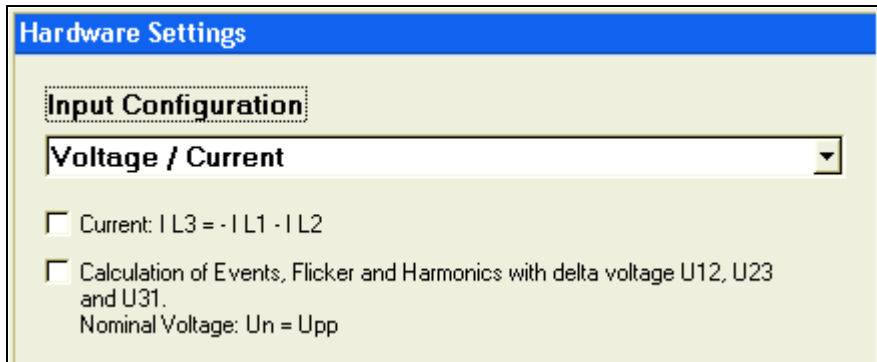

Figure 3-5. Circuit Diagram: 4-Wire

3wattm2.eps

Associated PC Software Settings:



messsystem1 u-i-0.bmp

If required, you have the option to determine events, Flicker and Harmonics, of the phase-to-phase voltages.

Check the respective option.

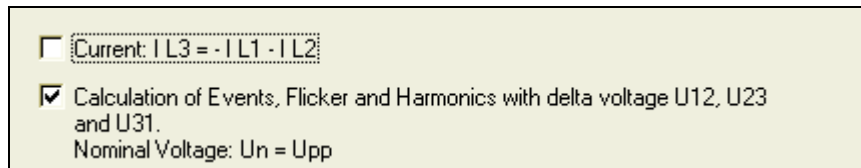

messsystem1 u-i-2.bmp

*Note*

*If this option (Calculation) is checked, you have to enter the phase-to-phase voltage as the rated voltage  $V_N$  in 'Settings – Nominal / Limit Values' (e.g. 400 V in the 230 V P-N network).*

**Two Star-Connected Voltage Systems**

With this method, you can determine two phase voltages and the respective N conductor voltages in two star connected three-phase systems.

Figure 3-6 shows the circuit diagram for 2-voltage system with neutral.

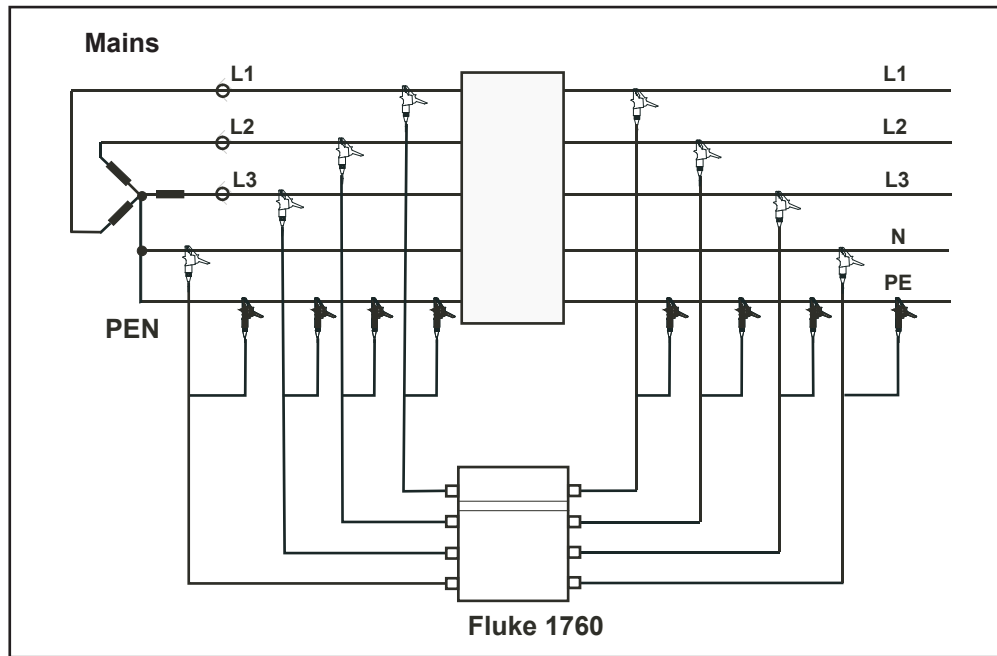

**Figure 3-6. Circuit Diagram: 2 Voltage System with Neutral**

System-U-U-Stern.eps

**Associated PC Software Settings:**

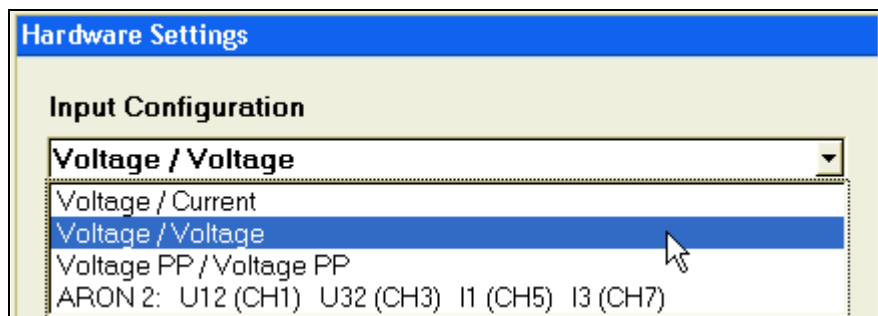

messsystem2.bmp

*Note*

*The power quality assessment according to EN50160 can be performed for the phase voltages of system 1 and system 2 respectively; the preset limit values apply to both evaluations.*

If required, you have the option to determine events, Flicker and Harmonics, of the phase-to-phase voltages.

Check the respective option.

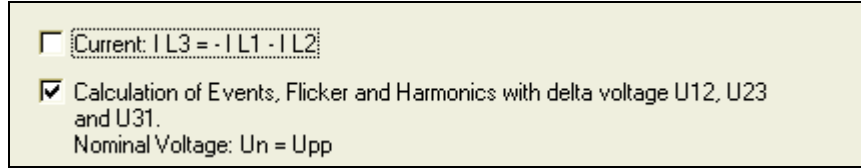

messsystem1 u-i-2.bmp

*Note*

*If this option (Calculation) is checked, you have to enter the phase-to-phase voltage as the rated voltage  $V_N$  in 'Settings – Nominal / Limit Values' (e.g. 400 V in the 230 V P-N network).*

**Two Voltage Systems in Delta Configuration**

This method is used to measure 3 phase-to-phase voltages in two delta-configured three-phase systems. Channels CH4 and CH8 can be used for other parameters.

Figure 3-7 shows the circuit diagram for 2-voltage system in Delta connection.

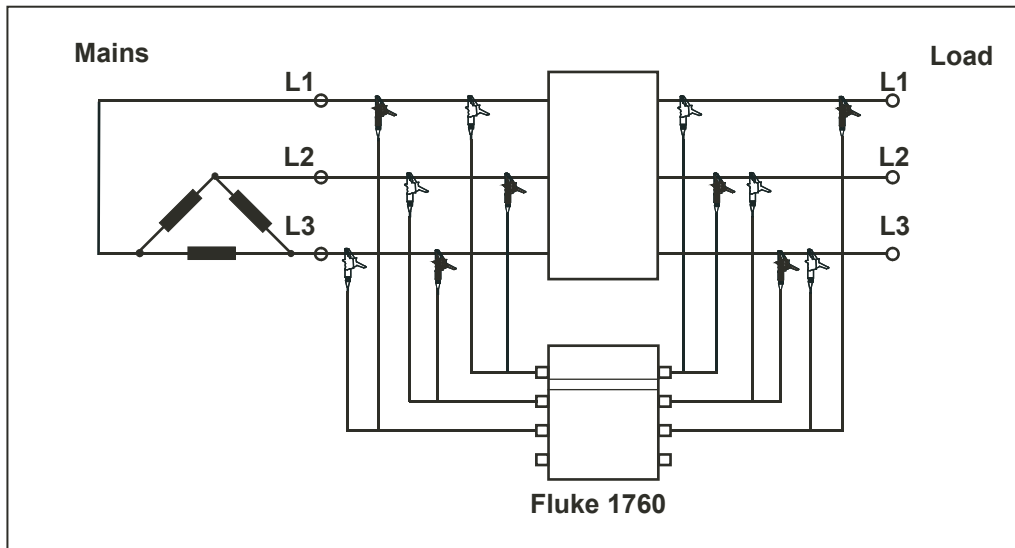

system u-u dreieck.eps

**Figure 3-7. Circuit Diagram: 2 Voltage System in Delta Connection**

**Associated PC Software Settings:**

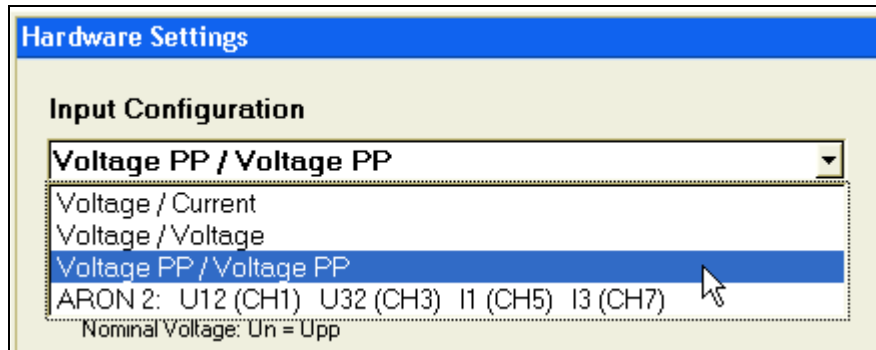

messsystem4.bmp

*Note*

*The power quality assessment according to EN50160 can be performed for the phase-to-phase voltages of system 1 and system 2 respectively; the preset limit values apply to both evaluations.*

*We have to enter the phase-to-phase voltage as the rated voltage  $V_N$  in 'Settings – Nominal/Limit Values' (e.g. 400 V in the 230 V P-N network).*

## Methods of Measurement/Formulas

### Parameter Aggregation

#### Signal Sampling

The device samples measurement signals at a nominal frequency of 10.24 kHz at nominal power frequencies of 50 Hz and 60 Hz respectively.

The sampling frequency is synchronized to the power frequency on the reference channel CH1, the signal level has to be at least 10 % of the input range. The required PLL (Phase Locked Loop) is realized in the firmware of the instrument.

The synchronization range is according to IEC 61000-4-30 class A:

- Range for 50 Hz systems: 50 Hz  $\pm 15\%$  (42.5 Hz - 57.5 Hz)
- Range for 60 Hz systems: 60 Hz  $\pm 15\%$  (51 Hz - 69 Hz)
- Resolution: 16 ppm

#### Aggregations

The time aggregation of the measurement values is according to IEC 61000-4-30 class A, section 4.5 based on 10/12 cycle values (10 cycles for 50 Hz and 12 cycles for 60 Hz nominal frequency).

The following time aggregations are available:

- Half cycle, full cycle updated every half cycle, 200 ms (precisely: 10/12 cycle values), 3 s (precisely: 150/180 cycles), 10 minutes, 2 hours, Free interval ( $\geq 10$  seconds)
- Half cycle and full cycle values are based on the zero crossings of the fundamental

- The 10/12 cycle values are aggregated from 2.048 samples synchronized to the power frequency
- The 3s (150/180 cycles)-intervals are derived from 15 consecutive 10/12 cycle intervals
- The 10 minute and free interval values are based on the synchronized 10/12 cycle values
- 2 hours interval is aggregated from 12 – ten minute intervals
- The 10 minute values are synchronized to the absolute time (e.g. via GPS time sync option)

### **Power Frequency**

For 10 s frequency values, the sample data are filtered by a 2<sup>nd</sup> order IIR filter (the 3 dB cut-off frequency is 50 Hz for 50 Hz nominal frequency and 60 Hz for 60 Hz nominal frequency). Based on the filtered signal whole periods within 10 s intervals (taken from the internal real time clock) are counted by detecting the zero crossings. The frequency is calculated by dividing the number of whole periods by the duration of this number of whole periods. The time interval is derived from the timestamps generated by the hardware of the first and the last sample within the block of whole periods. A special calculation method is used for the frequency measurement related to the 10 ms and 20 ms (half/full cycle) rms values. The measured frequency is the sync frequency of the PLL which is refreshed every 200 ms (based on the FFT evaluation).

### **Voltage, Current rms Values, Min-/Max-Values**

Half cycle rms is synchronized with the zero crossings of the fundamental component. The fundamental component zero crossing is calculated from 200 ms FFT. Half cycle rms is available as real half cycle rms and/or as full cycle rms, updated every half cycle.

The extreme values (Min-, Max-values) are derived from the half cycle rms values or full cycle rms values updated every half cycle (whatever is configured in the “Nominal and Limit Values” settings panel in PQ Analyze).

The interval values are averaged squared over the respective time interval.

### **FFT – Fast Fourier Transformation**

FFT is calculated using an algorithm which is optimized for real input and complex output with 2.048 points. As long as the PLL controlling the sampling frequency is locked, no window function is applied. If locking cannot be established, a Hanning window is used. The FFT is calculated over 200 ms intervals and therefore results in a frequency spectrum of 1024 5 Hz bins (DC to 5115 Hz).

### **Calculation of Power Parameters**

Two different sets of power parameter calculations are used. One for aggregations of 200ms and higher the other one for half and full cycle aggregations.

#### **Aggregations 200 ms and higher**

##### **Real power**

Real power  $P$  is derived from the results of the FFT calculations of voltage and current.

$$P = \sum_{i=0}^{1023} U_i \cdot I_i \cdot \cos \varphi_i$$

where

$U_i$  rms value of the voltage bin with the frequency  $5 \cdot i$  Hz

$I_i$  rms value of the current bin with the frequency  $5 \cdot i$  Hz

$\varphi_i$  phase angle difference between voltage and current of the frequency  $5 \cdot i$  Hz

The 3-phase real power sum is calculated as

$$P_{sum} = P_{L1} + P_{L2} + P_{L3}$$

### Apparent power

Apparent power  $S$  is calculated by multiplying rms values of voltage and current of the given aggregation.

$$S = U \cdot I$$

The 3-phase apparent power sum is calculated as

$$S_{sum} = S_{L1} + S_{L2} + S_{L3}$$

### Reactive power

The harmonic reactive power  $Q_h$  is also derived from the results of the FFT calculations of voltage and current. The index  $h$  in  $Q_h$  indicates that the calculated reactive power component is derived from the harmonics (FFT) calculation.

$$Q_h = \sum_{i=0}^{1023} U_i \cdot I_i \cdot \sin \varphi_i$$

Because every frequency component of the calculation has a sign,  $Q_h$  is also signed. All other reactive power components are unsigned (always positive) by definition.

The 3-phase harmonic reactive power sum is calculated as

$$Q_{h\ sum} = Q_{h\ L1} + Q_{h\ L2} + Q_{h\ L3}$$

The total reactive power  $Q_{tot}$  is calculated by

$$Q_{tot} = \sqrt{S^2 - P^2}$$

The 3-phase total reactive power sum is calculated as

$$Q_{tot\ sum} = Q_{tot\ L1} + Q_{tot\ L2} + Q_{tot\ L3}$$

The remaining reactive power component  $Q_d$  (d stands for distortion) contains the rest of the reactive power phenomena (mainly distortion reactive power and modulation reactive power, the first originating e.g. from power converters with highly non sinusoidal current waveforms, the latter from pulsating loads).

$$Q_d = \sqrt{Q_{tot}^2 - Q_h^2}$$

The 3-phase distortion reactive power sum is calculated as

$$Q_{d\ sum} = Q_{d\ L1} + Q_{d\ L2} + Q_{d\ L3}$$

Please note that the quadratic terms in the  $Q_d$  calculation means that

$$Q_{d\ sum} \neq \sqrt{Q_{tot\ sum}^2 - Q_h^2}$$

### Power factor

For the power factor one of two different formulas can be selected by the user through the “Options > Power Factor” menu in PQ Analyze.

Formula 1: The sign is taken from the reactive harmonic power therefore giving an indication about inductive or capacitive characteristic of the load.

$$PF = \frac{|P|}{S} \cdot \frac{Q_h}{|Q_h|}$$

Formula 2: The sign is taken from the real power therefore giving the power flow direction (motor / generator characteristic of the load).

$$PF = \frac{P}{S}$$

The 3-phase power factor sum is calculated as

$$PF_{sum} = \frac{|P_{sum}|}{S_{sum}} \cdot \frac{Q_{h\ sum}}{|Q_{h\ sum}|} \text{ or } PF_{sum} = \frac{P_{sum}}{S_{sum}}$$

### Displacement power factor $\cos \varphi$

The  $\cos \varphi$  is most commonly referred to as the power factor of the fundamental component. More general there is a  $\cos \varphi$  for every harmonic frequency component.

When you select the harmonics analysis in the main analysis window in PQ Analyze you can display the  $\cos \varphi$  for all harmonics including the fundamental.

Harmonics analysis parameter group: 

The formula used for calculating the  $\cos \varphi$  is:

$$\cos \varphi_i = \cos \left( \arctan \left( \frac{Q_i}{|P_i|} \right) \right)$$



where

$P_i$  Real power of harmonic order  $i$

$Q_i$  Reactive power of harmonic order  $i$

For historic reasons the  $\cos \varphi$  parameter is also included in the V-I-P parameter group:



Calculation formula:

$$\cos \varphi = \cos \left( \arctan \left( \frac{Q_h}{|P|} \right) \right)$$

where

$P$  Real power

$Q_h$  Harmonic reactive power

*Note*

*If you want to display the displacement power factor of the fundamental component select the harmonics analysis parameter group and choose the fundamental component in the drop-down list of available parameters.*

### Half and full cycle aggregations

#### Real power

Real power  $P$  is calculated by directly multiplying the samples of voltage and current in the time domain.

$$P = \frac{\sum_{i=1}^n u(i) \cdot i(i)}{n}$$

where

$u(i)$  the  $i$ -th voltage sample of the cycle or half cycle

$i(i)$  the  $i$ -th current sample of the cycle or half cycle

$n$  the number of samples per cycle or half cycle

*Note*

*There is no integer number of samples per cycle or half cycle (neither for 50 Hz nor for 60 Hz systems). A 50 Hz cycle consists of 204.8 samples a 60 Hz cycle of 170.67 samples. Therefore the calculation uses sample interpolation.*

The 3-phase real power sum is calculated as

$$P_{sum} = P_{L1} + P_{L2} + P_{L3}$$

### Apparent power

Apparent power  $S$  is calculated by multiplying rms values of voltage and current of the given aggregation.

$$S = U \cdot I$$

The 3-phase apparent power sum is calculated as

$$S_{sum} = S_{L1} + S_{L2} + S_{L3}$$

### Reactive power

The reactive power  $Q_{tot}$  is calculated by

$$Q_{tot} = \sqrt{S^2 - P^2}$$

$Q_{tot}$  always has a positive sign.

The 3-phase total reactive power sum is calculated as

$$Q_{tot\ sum} = Q_{tot\ L1} + Q_{tot\ L2} + Q_{tot\ L3}$$

#### Note

*The reactive power components  $Q_h$  and  $Q_d$  are not calculated with these aggregations.*

### Power factor

The power factor is calculated as

$$PF = \frac{P}{S}$$

The sign of the power factor is an indication of the power flow direction (motor / generator characteristic of the load).

### Events and Flicker

#### Voltage Events as per EN 50160 or as per IEC 61000-4-30

Voltage events are detected based on half cycle rms values (as per EN 50160) or on full cycle rms values updated every half cycle (as per IEC 61000-4-30). As a default, the phase-neutral voltages are monitored. If the option *Events, Flicker, and Harmonics of U12....* is activated in the “Hardware Settings” dialog in PQ Analyze, the voltage events of the phase-to-phase voltages U12, U23, U31 are recorded.

#### Flicker

Flicker is measured according to the methods described by the standard IEC 61000-4-15:2003-02 edition 1.1. As a default Flicker is calculated on the basis of the phase voltages. For 50 Hz or 60 Hz power systems the appropriate filter coefficients are applied. The classifier consists of 1130 logarithmic classes.

If the option *Events, Flicker, and Harmonics of U12....* in the device settings is activated, the Flicker of the phase-to-phase voltages U12, U23, U31 is recorded.

## Harmonics and Interharmonics Parameters

### Voltage and Current Harmonics and Interharmonics

Voltage and current harmonics are calculated based on a 10/12 cycle (200ms) averaging interval. This interval contains exactly 2048 sample values. From these samples 1024 FFT bins (5Hz) are calculated.

The harmonics are then calculated using a gapless harmonic subgroup assessment.

The interharmonics are calculated using a gapless interharmonic centered subgroup assessment.

Harmonics and interharmonics calculation as per IEC 61000-4-7:2002 section 5.6 (no smoothing).

### THD – (Total Harmonic Distortion)

The calculation utilizes the following formula: Voltage or current respectively.

$$THD = \sqrt{\frac{\sum_{n=2}^{40} V_n^2}{V_1^2}}$$

n: order of the harmonic.

$V_1$ : rms value of the voltage fundamental.

$V_n$ : rms value of the voltage harmonic with order n.

$$THD = \sqrt{\frac{\sum_{n=2}^{40} I_n^2}{I_1^2}}$$

n: order of the harmonic.

$I_1$ : rms value of the current fundamental.

$I_n$ : rms value of the current harmonic with order n.

### TID

TID is the complete interharmonics contents of the signal. It is calculated as per EN 61000-4-7:1993 from all interharmonics spectral bins (absolute values) up to the harmonic with order 40.

### THD ind

THD ind is calculated according to the formula in the norm EN61000-4-7:1993. This formula is no more part of the actual version of EN 61000-4-7 but has still importance for applications in networks with inductive loads.

$$THD_{ind} = \frac{1}{V_1} \sqrt{\sum_{n=2}^{40} \frac{V_n^2}{n}}$$

n: Order of the harmonic.

$V_1$ : rms value of the voltage fundamental.

$V_n$ : rms value of the voltage harmonic with order n.

### THD cap

THD cap is calculated according to the formula in the norm EN61000-4-7:1993. This formula is no longer part of the most recent version of EN 61000-4-7 but has still importance for applications regarding reactive power compensation equipment.

$$THD_{cap} = \frac{\sqrt{\sum_{n=2}^{40} n^2 * V_n^2}}{V_1}$$

n: Order of the harmonic.

V<sub>1</sub>: rms value of the voltage fundamental.

V<sub>n</sub>: rms value of the voltage harmonic with order n.

### K-Factor and Factor K

The two parameters are meant to assess transformer losses.

Harmonic currents are generated whenever a non-linear load is connected to the mains supply. The problems caused by harmonic currents include overheating of cables, especially the neutral conductor, overheating and vibration in induction motors and increased losses in transformers. Where power factor capacitors are fitted, harmonic currents can damage them and care must be taken to avoid resonance with the supply inductance.

Losses in transformers are due to stray magnetic losses in the core, and eddy current and resistive losses in the windings. Of these, eddy current losses are of most concern when harmonics are present, because they increase approximately with the square of the frequency.

There are two distinct approaches to accounting for this increased eddy current loss in selecting a transformer. The first, devised by transformer manufacturers in conjunction with Underwriters Laboratories in the United States, is to calculate the factor increase in eddy current loss and specify a transformer designed to cope; this is known as 'K-Factor'. The second method, used in Europe, is to estimate by how much a standard transformer should be de-rated so that the total loss on harmonic load does not exceed the fundamental design loss; this is known as 'Factor K'. The figures produced by each method are numerically different; 'Factor K' is a total rating factor while 'K-Factor' is a multiplier (although a de-rating factor can be derived from it). The fact that both methods use K as a designation can lead to confusion when talking to suppliers.

K-Factor formula:

$$K = \frac{P_t}{P_f} = \sum_{h=1}^{h=50} I_h^2 h^2$$

where

$P_t$  total eddy current loss

$P_f$  eddy current loss at fundamental frequency

$I_h$  relative harmonic current component at order h (relative to fundamental)

$h$  harmonic order

Factor K formula:

$$K = \sqrt{1 + \frac{e}{1+e} \left(\frac{I_1}{I}\right)^2 \sum_{n=1, n+2}^{n=50} \left( n^q \left(\frac{I_n}{I_1}\right)^2 \right)}$$

where

$e$  eddy current loss at the fundamental frequency divided by the loss due to a dc current equal to the RMS value of the sinusoidal current (constant factor to be entered by the user – see dialog below)

$q$  exponential constant that is dependent on the type of winding and frequency. Typical values are 1.7 for transformers with round or rectangular cross section conductors in both windings and 1.5 for those with foil low voltage windings (to be entered by the user – see dialog below)

$I$  rms value of the sinusoidal current including all harmonics

$I_n$  magnitude of the harmonic current of order n

$I_1$  magnitude of the fundamental current component

$h$  harmonic order

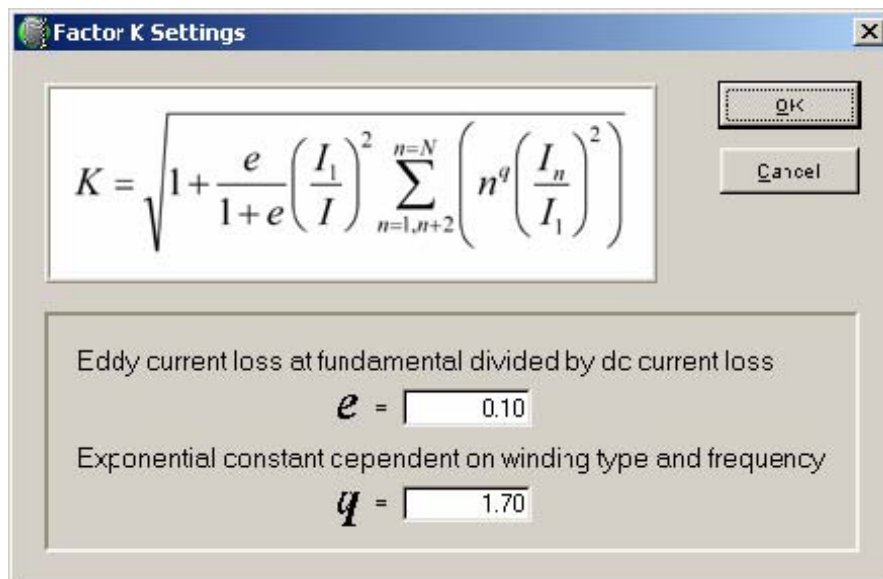

3\_1.bmp

PQ Analyze supports both formulas, the user can select the formula he wants to use.  
K-Factor (US) and Factor K (EU) are only available via the *Measurement* menu.

## Signaling Voltage

### Ripple Control Signals

The frequency of the ripple control signal of the local utility can be defined in the PQ Analyze software in the trigger settings dialogue. These signals are calculated from the FFT results. The FFT bin related to the signaling voltage is calculated from the rated signaling frequency and the nominal power frequency (derived from the 50 Hz or 60 Hz setting in the PQ Analyze software) using 2.048 samples per 10/12 cycle interval with 10.24 kHz sample rate. If the signaling voltage corresponds to the frequency of a FFT bin within 1 % (referred to the bin spacing), only this bin is used. Otherwise, the rms values of four neighboring FFT bins are added, giving the rms value of the signaling frequency. 200 ms and 3 s aggregations are available.

## Unbalance, Overdeviation, Underdeviation

### Unbalance

The unbalance (imbalance) is derived from the symmetrical components as per IEC 61000-4-30 class A section 5.7.1. based on the 10/12 cycle values of the voltage fundamentals. The symmetrical components are calculated as:

$$V_Z = \frac{1}{3} \sqrt{(V_1 + V_2 * \cos \varphi_{12} + V_3 * \cos \varphi_{13})^2 + (V_2 * \sin \varphi_{12} + V_3 * \sin \varphi_{13})^2}$$

$$V_P = \frac{1}{3} \sqrt{V_1 + V_2 * \cos(\varphi_{12} + 120^\circ) + V_3 * \cos(\varphi_{13} + 240^\circ)^2 + V_2 * \sin(\varphi_{12} + 120^\circ) + V_3 * \sin(\varphi_{13} + 240^\circ)^2}$$

$$V_N = \frac{1}{3} \sqrt{V_1 + V_2 * \cos(\varphi_{12} + 240^\circ) + V_2 * \cos(\varphi_{13} + 120^\circ)^2 + V_2 * \sin(\varphi_{12} + 240^\circ) + V_3 * \sin(\varphi_{13} + 120^\circ)^2}$$

$V_Z, V_P, V_N$	rms values of zero, positive, and negative system
$V_1, V_2, V_3$	rms values of the fundamentals of the phase voltages
$\varphi_{12}, \varphi_{13}$	phase angles between phases 1 and 2, phases 1 and 3 (nominal: -120° and -240°)

**Calculation of unbalance as per IEC 61000-4-30:**

$$V_2 = \frac{V_N}{V_P} * 100\%$$

$$V_0 = \frac{V_Z}{V_P} * 100\%$$

V<sub>Z</sub>: zero system

V<sub>P</sub>: positive system

V<sub>N</sub>: negative system

The calculation of V<sub>0</sub>, V<sub>2</sub> utilizes the above formulas for V<sub>Z</sub>, V<sub>P</sub>, V<sub>N</sub> or for a 3-wire system the following formulas with phase-phase voltages (same results):

$$V_2 = \sqrt{\frac{1 - \sqrt{3 - 6\beta}}{1 + \sqrt{3 - 6\beta}}} * 100\%$$

$$\beta = \frac{V_{12,k1}^4 + V_{23,k1}^4 + V_{31,k1}^4}{(V_{12,k1}^2 + V_{23,k1}^2 + V_{31,k1}^2)^2}$$

*Note*

*For a 3-wire network the zero system component V<sub>z</sub> is 0 per definition.*

*The voltage values are averaged squared versus time, afterwards the unbalance is calculated for the time interval.*

For more information, see Table 3-2.

**Current Unbalance**

In addition to the system component parameters that are available for voltage measurement (zero system, positive system, negative system) for current there is the special current unbalance calculation.

In some applications when you want to check if the current load of the power system is distributed equally over the three phases this simpler calculation of current unbalance is preferred.

Calculation:

Calculate average current  $I_{avg} = (I_1 + I_2 + I_3)/3$

Find the maximum deviation from this average current.

Maximum value of  $\max(|I_1 - I_{avg}|, |I_2 - I_{avg}|, |I_3 - I_{avg}|)$

Current unbalance is  $100 * \max(|I_1 - I_{avg}|, |I_2 - I_{avg}|, |I_3 - I_{avg}|) / I_{avg}$

The purpose is to have a simple indicator of detecting an unbalanced current load in a 3-phase system based on the RMS values only. The phase angles do not matter in this calculation.

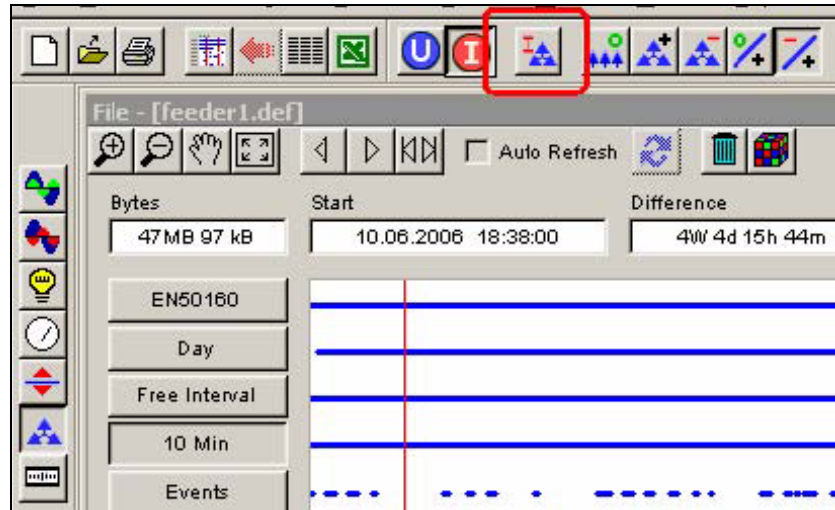

3\_2.bmp

### Overdeviation and Underdeviation

The Over- and Underdeviation parameters give an indication if the signal in a given aggregation was higher or lower than the nominal voltage.

The formulas according to IEC 61000-4-30 are:

Underdeviation

$$U_{under} = 0 \text{ if } U_{r.m.s.} > U_{nom}$$

otherwise

$$U_{under} = \left( \frac{U_{nom} - U_{r.m.s.}}{U_{nom}} \right) \cdot 100\%$$

Overdeviation:

$$U_{over} = 0 \text{ if } U_{r.m.s.} < U_{nom}$$

otherwise

$$U_{over} = \left( \frac{U_{r.m.s.} - U_{nom}}{U_{nom}} \right) \cdot 100\%$$

These parameters give additional information for assessing the stability of the voltage.







# **Chapter 4**

## **Maintenance**

<b>Title</b>	<b>Page</b>
Introduction.....	4-3
Maintenance of Battery Package .....	4-3
Cleaning .....	4-3
Replacement of Battery Pack.....	4-4
Decommissioning and Disposal.....	4-4
Shutting Down.....	4-4
Recycling and Disposal .....	4-5
Warranty .....	4-5
Recalibration.....	4-5



## Introduction

The instrument itself is maintenance-free.

## Maintenance of Battery Package

### Note

*We recommend carrying out a forced battery discharge at regular time intervals (no longer than 3 months) to maintain the battery capacity as long as possible. It is recommended to replace the battery every 2 years to ensure full operational readiness for UPS.*

### Procedure:

1. Connect the instrument to mains.
2. Set the mains switch to the I-position.
3. Wait until the POWER LED is on.
4. Disconnect the power supply.
5. Wait until the POWER LED goes off.
6. Set the mains switch to the 0-position.
7. Wait until the LEDs POWER and UPS are flashing rapidly.
8. Within 3 second set the mains switch to I-position again.

The battery package will be discharged completely when:

- LED POWER is OFF
- LED UPS is flashing slowly
- LEDs MEMORY LEVEL show flashing light, the number of LEDs lighting up indicates the remaining time period for discharging in minutes (e.g. 5 LEDs means that the discharging will last for appr. 5 minutes)
- Afterwards the instrument is turned off automatically

### Note

*For terminating the forced discharge mode at any time, connect instrument to mains or set the mains switch to the 0-position.*

## Cleaning

The device can be cleaned with an Isopropanol impregnated cloth.

### Caution

**Do not use abrasives or other solvents.**

## Replacement of Battery Pack

### Warning

- Disconnect all the sensors from the instrument's input connectors.
- Disconnect the instrument from the power supply.
- Do not short circuit the terminals of the battery pack.
- For replacement of the battery pack, use the original spare parts only (PN 2540406).



*Always adhere to the applicable statutory regulations for recycling and waste disposal.*

### Procedure:

1. Locate the battery compartment on the backside of the instrument.
2. Remove the screw of the lid with a screwdriver (Pozi-drive).
3. Unlock and remove the connector cable.
4. Replace the battery pack by an original spare part (PN 2540406) using the attached strip.
5. Connect the cable to the plug of the instrument.

### *Note*

*Note the polarity of the plug and the locking mechanism.*

## Decommissioning and Disposal

### Shutting Down

1. Ensure that all the devices connected to measuring circuits are disconnected from the measuring circuits.
2. Switch off the Power Quality Recorder.
3. Disconnect the plug from the mains socket.
4. Remove all the connected devices.
5. Secure the unit against inadvertent switching on.
6. Ensure that the operating manual is kept near the device.

## Recycling and Disposal



*Always adhere to the applicable statutory regulations for recycling and waste disposal. Do not dispose in domestic household waste.*

<i>Packaging:</i>	Packaging consists solely of recycleable material. For any packaging disposal licenses for your country, contact your distributor or retailer.
<i>Housing:</i>	The housing is made of insulating plastics material.
<i>Weight, Volume:</i>	The instrument has a weight of approx. 4.900 g (10.8 lbs) and a volume of approx. 4.700 cm <sup>3</sup> (287 cubic in).

## Warranty

The warranty period for the instrument is limited to 2 years, the specified uncertainty of measurement is limited to 1 year from the date of purchase.

The warranty is not valid for batteries.

The warranty is only valid if accompanied with the respective invoice or receipt of payment.

Damages due to improper use, overload or operation under conditions that are outside the range of permitted ambient conditions are not covered by the warranty.

Warranty covers only technical data that is specified with a tolerance range. Values or limits for which there are no tolerances specified are intended for information purposes only.

## Recalibration

Fluke recommends recalibrating the device every year if the instrument is operated over the full operating temperature range. For operation between +15 °C and +35 °C the calibration period can be extended to 2 years. For an accuracy of 0.5 % for voltages and 1 % for currents, 5 years calibration period is recommended.

The device can be calibrated by the Fluke service department or any other calibration specialist.





# **Chapter 5**

## ***Specifications***

<b>Title</b>	<b>Page</b>
General Specifications .....	5-3



## General Specifications

Intrinsic uncertainty	refers to reference conditions and is guaranteed for one year
Quality system	developed, manufactured as per ISO 9001: 2000
Ambient conditions	
Operating temp. range	0 °C... +50 °C; 32 °F... +122 °F
Working temp. range	-20 °C... +50 °C; -4 °F... +122 °F
Storage temp. range	-20 °C... +60 °C; -4 °F... 140 °F
Reference temperature	23 °C ± 2 K; 74 °F ± 2 K
Climatic class	B2 (IEC 654-1), -20 °C... +50 °C; -4 °F +122 °F
Max. Voltage to earth/ Overvoltage category	Altitude: 2000 m: max. 600 V CAT IV* Basic unit and mains supply: 300 V CAT III Altitude: 5000 m: max 600 V CAT III* Basic unit and mains supply: 300 V CAT II * depending on the connected sensor
Reference conditions	Environment temp.: 23 °C ± 2 K < 60 % rH; 74 °F ± 2 K < 60 % RH Power frequency: 50 Hz / 60 Hz Signal: declared input voltage U <sub>in</sub> Averaging: 10 minute intervals Warmed up instrument > 3 h Power supply: 120 V/60 Hz or 230 V/50 Hz, ± 10 %
Housing	insulated, robust plastics housing
Protection	IP40
Electrical safety	EN 61010-1 2nd edition, basic unit 300 V CAT III entire measuring system depending on the used sensors from 300V CATII up to 600V CATIV (1000V CATIII)
Power supply	83 to 264 V ac, 35 W, < 70 V A 45 to 65 Hz dc: 100 to 375 V
Environmental	Pollution Degree 2, Protection class I
Emissions/Immunity	IEC 61326-1:2006
Display	Fluke 1760 features LED indicators for the status of the 8 channels, phase sequence, power supply (mains or accumulator), memory usage, time synchronization, and data transfer.
Power LED	<ul style="list-style-type: none"> <li>• Permanent light: normal power supply from mains.</li> <li>• OFF: supply via internal accumulator in case of a power failure.</li> </ul>

Channel LEDs	3-color LEDs per channel for: <ul style="list-style-type: none"> <li>• overload condition</li> <li>• OK and signal level too low condition</li> </ul> signal level in nominal range
Data memory	2 GB Flash memory
Memory model	Selectable : Linear or circular
Recording mode	Continuous, gapless recording
Measurement system	4 voltages + 4 currents for 3 phases + N conductor or 8 voltages
Interfaces	Ethernet (100 MB/s), compatible to Windows® 2000/XP SP3/Vista, RS 232 and USB 2.0
Baud rate for RS 232	9600 Baud ... 115 kBaud
Dimensions (H x W x D)	325 mm x 300 mm x 65 mm (13 x 12 x 2.6 inch)
Weight (without accessories)	approximately 4.9 kg (10.8 lbs)
Warranty	2 years
Calibration interval	1 year recommended for Class-A, otherwise 2 years
Signal conditioning	Specification
<b>Range for 50 Hz systems</b>	50 Hz ± 15 % (42.5 Hz to 57.5 Hz)
<b>Range for 60 Hz systems</b>	60 Hz ± 15 % (51 Hz to 69 Hz)
Frequency Resolution	16 ppm
Sampling frequency for 50 Hz and 60 Hz nominal power frequency	10.24 kHz, The sampling rate is synchronized to mains frequency.
Uncertainty for frequency measurements	< 20 ppm
Uncertainty of internal clock	< 1s / day
Measurement intervals Min-Max-values Transients	Aggregation of the interval values as per IEC 61000-4-30 Class-A Half cycle Sample rate 100 kHz to 10 MHz per channel

Harmonics Range Intrinsic uncertainty basic aggregation interval 200 ms	<25 % of VRMS fundamental up to a THD of 50 % $\geq 1\%$ Vnom: $\pm 5\%$ of reading $< 1\%$ of Vnom: $\pm 0.05\%$ of Vnom as per IEC 61000-4-7:2002 and amendment 1:2008, IEC 61000-2-4 Class 3
Interharmonics Range Intrinsic uncertainty basic aggregation interval 200 ms	<25 % of VRMS fundamental up to a TID of 50 % $\geq 1\%$ Vnom: $\pm 5\%$ of reading $< 1\%$ of Vnom: $\pm 0.05\%$ of Vnom as per IEC 61000-4-7:2002 and amendment 1:2008
Conditions for Harmonics and Interharmonics Specifications Temperature Humidity Supply voltage Common mode interference voltage Static electricity discharge Radiated electric fields	within operating temperature range 10%-60% r.H. 83 - 264 V ac, 45 - 65 Hz, 100 - 375 V dc $\leq$ Vnom IEC 61326-1 / industrial environment IEC 61326-1 / industrial environment
Voltage unbalance – Range Intrinsic uncertainty	0 to 100 % $\pm 0.15\%$ absolute deviation
Flicker	as per EN 61000-4-15:2003: 10 min (Pst), 2 h (Plt)
All PQ parameters are evaluated in accordance with IEC 61000-4-30 Class A, 2008 Edition 2 In regulations the standard expression for $V_{nom}$ is $U_{nom}$	

<b>Measurement inputs</b>	
Number of inputs	8 galvanically isolated inputs for voltage and current measurements.
Sensor safety	up to 600 V CAT IV depending on sensor
Basic unit safety rating	300 V CAT III
Nominal voltage (rms)	100 mV
Range (peak value)	280 mV
Overload capacity (rms)	1000 V, continuously
Voltage rise rate	max. 15 kV / $\mu$ s
Input resistance	1 M $\Omega$ for instrument, 1000 V sensor 10 M $\Omega$
Input capacitance	< 50 pF
Input filter	Each channel is equipped with a passive low-pass filter, an anti-aliasing filter and a 16-bit A/D converter. All channels are sampled synchronously with a common quartz-controlled clock pulse. The filters protect against voltage transients and limit the signal rise rate, reduce high frequency components and especially the noise voltage above half the sampling rate of the A/D converter by 80 dB, thus achieving very small measuring errors in an exceptionally large amplitude range. This is also valid under extreme operating conditions like transient voltages at the output of converters.



## **Chapter 6**

# **Options and Accessories**

<b>Title</b>	<b>Page</b>
Instruments.....	6-3
Accessories .....	6-3
Standard Voltage Probes for AC and DC.....	6-4
Flexible Current Probes for AC.....	6-5
Current Probes for AC Currents.....	6-5
Shunt Resistors for AC and DC Currents.....	6-6
Other Accessories.....	6-6
Current Clamp 1 A/10 A AC.....	6-6
Current Clamp 5 A/50 A AC.....	6-10
Current Clamp 20 A/200 A AC.....	6-14
Flexi Current Sensor 100 A/500 A.....	6-17
Flexi Current Sensor 200 A/1000 A.....	6-21
Flexi Current Sensor 3000 A/6000 A.....	6-24
GPS-Time Synchronization Module Option.....	6-27





**Instruments**

Product	Description/technical specifications
<b>Fluke 1760 Basic</b> without fast transient without voltage and current sensors	<b>Power Quality Recorder/Analyzer</b> 8 channels (4 voltages/4 currents or 8 voltages) <b>Interfaces:</b> 1 RS 232 interface cable Ethernet 1 Ethernet cable for network connection 1 crosslink Ethernet cable for direct PC connection <b>Memory:</b> 2 GB Flash memory <b>CDROM:</b> PQ Analyze software and SW manual, operators guide on CDROM 1 mains cable, mains adapter set, for country specific connection 1 Getting Started Manual 1 carrying bag
<b>Fluke 1760TR Basic</b> with fast transient, without voltage and current sensors	The Fluke 1760 TR Basic includes all of the items in the Fluke 1760 Basic unit, plus. <b>Fast transient analysis</b> up to 10 MHz
<b>Fluke-1760 INTL</b> <b>Fluke-1760 US</b> without fast transient, with voltage and current sensors	<b>The Fluke 1760</b> includes all of the items in the Fluke 1760 Basic unit, plus. <b>INTL:</b> 4 voltage probes 600 V + two Dolphin clips for each probe <b>US:</b> 4 voltage probes 1000 V + two Dolphin clips for each probe 4 flexible current probes 1000 A/200 A <b>GPS time</b> sync receiver
<b>Fluke-1760TR INTL</b> <b>Fluke-1760TR US</b> with fast transient, with voltage and current sensors	<b>The Fluke 1760 TR</b> includes all of the items in the Fluke 1760 unit, plus. <b>Fast transient analysis</b> up to 10 MHz

**Accessories**

The voltage probes for various ranges between 0.1 V and 1000 V are available for the instrument.

The current sensor for direct current measurement (shunt) is available for 20 mA, 1 A, and 5 A.

The passive current clamps (ac only) are available in ranges with 1 A up to 200 A, 2 ranges can be selected in the PQ Analyze software.

The flexible current sensors (TPS Flex) are available for ranges between 100 A and 6000 A ac; 2 ranges can be selected in the PQ Analyze software.

All probes contain a memory for calibration factors, sensor identity, and serial number which is read automatically by the instrument. Ranges can be selected in the PQ Analyze software.

Other measuring transducers can be connected to the inputs of these sensors, such as mV output temperature sensors.

### Standard Voltage Probes for AC and DC

Temperature coefficient: 100 ppm/K  
 Aging: <0.05 %/year  
 All voltage sensors are suitable for DC for DC and AC up to 5 kHz

Voltage Probe	PN	V nom	Range V rms	max. overload continuous	Input resistance <sup>1</sup>	Intrinsic Uncertainty
TPS VOLTPROBE 0.1 V	2540613	0.1 V	10 mV - 0.2 V	100 V	1 MΩ	0.15 % of rdg ± 0.8 mV
TPS VOLTPROBE 10 V	2540636	10 V	0.1-17 V	100 V	16 kΩ	0.15 % of rdg ± 8 mV
TPS VOLTPROBE 100 V	2540624	100 V	1-170 V	1000 V	8.5 MΩ	0.15 % of rdg ± 80 mV
TPS VOLTPROBE 400 V	2540660	400 V	4-680 V	1000 V	8.5 MΩ	0.15 % of rdg ± 0.32 V
TPS VOLTPROBE 600 V	2540697	600 V	10-1000	1000 V	8.5 MΩ	0.1 % <sup>2</sup>
TPS VOLTPROBE 1000 V	2540649	1000 V	10-1700	2000 V	13 MΩ	0.1 % <sup>3</sup>

<sup>1</sup> between red and black connector  
<sup>2</sup> sensor + basic unit 0.1 % of U<sub>din</sub> = 230 V P-N in accordance with IEC61000-4-30 Class A  
<sup>3</sup> sensor + basic unit 0.1 % of U<sub>din</sub> = 480 V and 600 V P-N in accordance with IEC61000-4-30 Class A

Voltage Probe	PN	Transient Range <sup>1</sup>	Transient uncertainty	Max. Voltage to earth Overvoltage category
TPS VOLTPROBE 0.1 V	2540613	---	---	300V CATII
TPS VOLTPROBE 10 V	2540636	---	---	300V CATII
TPS VOLTPROBE 100 V	2540624	50-6000V	5 %	600V CATIV
TPS VOLTPROBE 400 V	2540660	50-6000V	5 %	600V CATIV
TPS VOLTPROBE 600 V	2540697	50-6000V	5 %	600V CATIV
TPS VOLTPROBE 1000 V	2540649	50-6000V	5 %	1000V CATIII / 600 V CAT IV

<sup>1</sup> signal duration <1ms

**Flexible Current Probes for AC**

Model No. Product No	Type	Range Selectable Per Software	Peak Current for Sinusoidal Currents	Intrinsic Uncer- tainty (>1 % of range)	Frequency Range	Operating Voltage	Phase Error	Diameter
TPS Flex 18 PN 2540477	Flexible Current Probe	1 A – 100 A 5 A – 500 A	240 A 1350 A	1 %	45 Hz – 3.0 kHz	600 V CAT IV	0.5 °	45 cm (18 inch) length 2 m cable
TPS Flex 24 PN 2540489	Flexible Current Probe	2 A – 200 A 10 A – 1000 A	480 A 2700 A	1 %	45 Hz – 3.0 kHz	600 V CAT IV	0.5 °	61 cm (24 inch) length 2 m cable
TPS Flex 36 PN 2540492	Flexible Current Probe	30 A – 3000 A 60 A – 6000 A	10 kA 19 kA	1 %	45 Hz – 3.0 kHz	600 V CAT IV	0.5 °	91 cm (36 inch) length 4 m cable

**Current Probes for AC Currents**

Model No. Product No	Type	Range Selectable	Peak Current for Sinusoidal Currents	Intrinsic Uncertainty (>1 % of range)	Frequency Range	Operating voltage	Phase error	Jaw Opening
TPS CLAMP 10 A/1 A PN 2540445	Clip-on Current Trans- former	0.01 A – 1 A 0.1 A – 10 A	3.7 A 37 A	0.5 %	40 Hz – 10 kHz	300 V CAT IV	0.5 °	conductor cross- section 15 mm, (0.6 inch) 2 m cable
TPS CLAMP 50 A/5 A PN 2540461	Clip-on Current Trans- former	0.05 A – 5 A 0.5 A – 50 A	18 A 180 A	0.5 %	40 Hz – 10 kHz	300 V CAT IV	0.5 °	conductor cross- section 15 mm, (0.6 inch) 2 m cable
TPS CLAMP 200 A/20 A PN 2540450	Clip-on Current Trans- former	0.2 A – 20 A 2 A – 200 A	74 A 300 A	0.5 %	40 Hz – 10 kHz	300 V CAT IV	0.5 °	conductor cross- section 15 mm, (0.6 inch) 2 m cable

### Shunt Resistors for AC and DC Currents

Model No. Product No.	Type	Range	Peak Current for Sinusoidal Currents	Intrinsic Uncertainty (>1 % of range)	Frequency Range	Operating Voltage	Phase Error
TPS SHUNT 20 mA PN 2540553	SHUNT 20 mA	0 – 55 mA	77.8 mA $I_{max}=1.5 A$	0.2 %	DC 3.0 kHz	300 V CAT II	0.1 °
TPS SHUNT 1 A PN 2540548	SHUNT 1 A	0 – 2.8 A	4 A $I_{max}=5.5 A$	0.2 %	DC 3.0 kHz	300 V CAT II	0.1 °
TPS SHUNT 5 A PN 2540566	SHUNT 5 A	0 – 10 A	21.9 A $I_{max}=10 A$	0.2 %	DC 3.0 kHz	300 V CAT II	0.1 °

Errors in % of measuring range at 23 °C ± 2 K, for 48 – 65 Hz.

Phase angle error at nominal current.

$I_{max}$  maximum current without time limit.

### Other Accessories

Product	Description/technical specifications	Product- No.
Transport case	For Instrument and accessories	2540414
Safety adapter	With quick-break fuse of 100 kA circuit-breaking capacity	2540530
2 A quick-break fuse	With 100 kA circuit-breaking capacity	2540509
Battery pack	Replacement battery pack	2540406

### Current Clamp 1 A/10 A AC

This current probe has been designed for non intrusive, accurate measurements of small AC currents. Using latest technologies (internal memory for calibration data) provides current ranges from 0.01 A up to 10 A. The measurement range can be selected in the PQ Analyze software: *IAC1* or *IAC10*.

#### Warning

To protect against electrical shock:

- Use personal protective equipment measures as required by local government agencies, when attaching clamps to live circuits.
- Utilize the clamps only on insulated conductors, max. 600 V r.m.s. or dc to ground.

**Electrical Characteristics**

Nominal current In:	1 A/10 A AC rms
Measuring ranges:	0.01 A – 1 A or 0.1 A – 10 A
Crest factor:	< 3
Peak current:	3.7 A/37 A
Max. non destructive current:	Up to 100 A rms
Conductor position influence:	< 0.5 % of range for 50/60 Hz
Error due to adjacent conductor:	≤ 15 mA/A for 50 Hz
Phase error (to reference conditions):	< ±0.5 degrees
Frequency range (clamp without the instrument):	40 Hz – 10 kHz (–3 dB)
Temperature coefficient:	0.015 % of range/ °C
Safety:	300 V CAT IV, type C sensor, pollution degree 2

**General Characteristics**

Maximum conductor size:	<i>Diameter:</i> 15 mm. <i>Bus bar:</i> 15 x 17 mm
Cable length:	2 m
Operating temperature range:	–10 °C - +55 °C
Storage temperature range:	–20 - +70 °C
Operating humidity:	15 % - 85 % (non-condensing)
Weight (per clamp):	220 g
Order-number:	2540445

**Reference Conditions**

Environment temperature range:	+18 °C to +26 °C
Humidity:	20 to 75 % rh
Current:	Sinusoidal waveform with 48 to 65 Hz
Distortion factor:	<1 %, no DC component, stray field <40 A/m, conductor centered within the clamp jaws

**Safety Standards**

- IEC/EN 61010-1 2<sup>nd</sup> edition
- IEC/EN 61010-2-032
- IEC/EN 61010-031

**EMC Standards**

EN61326 –1:2006

*Accuracy (Typical, for 50/60 Hz)*

Linearity, error in % of measured value, primary current in A:

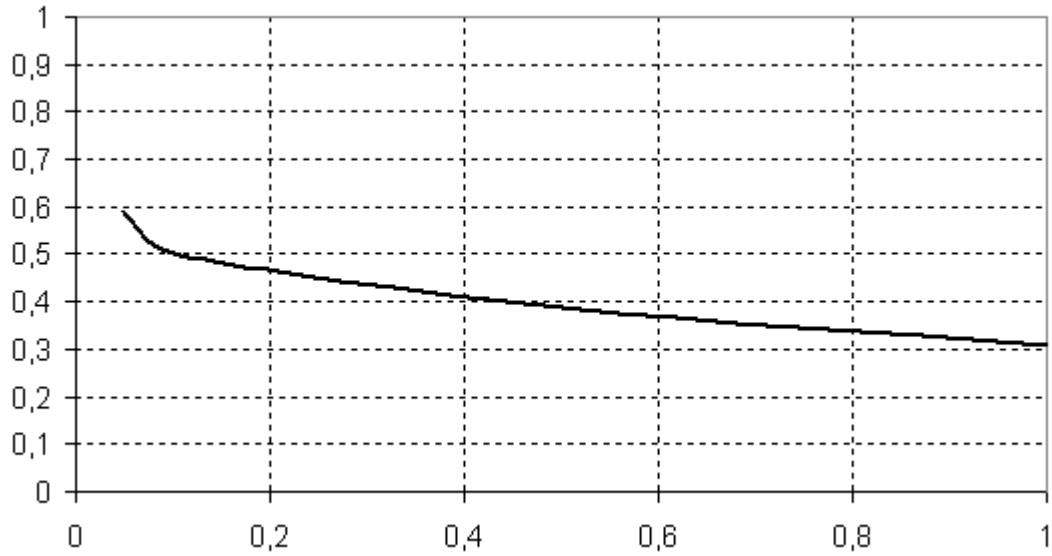

a680501049-linearity-1a.bmp

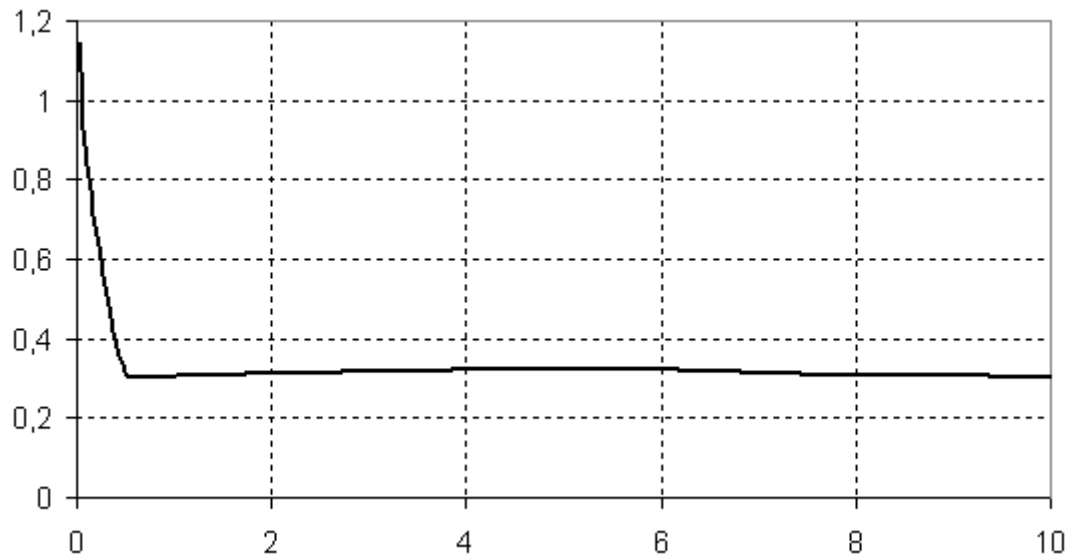

a680501049-linearity-10a.bmp

Phase angle in degrees, primary current in A:

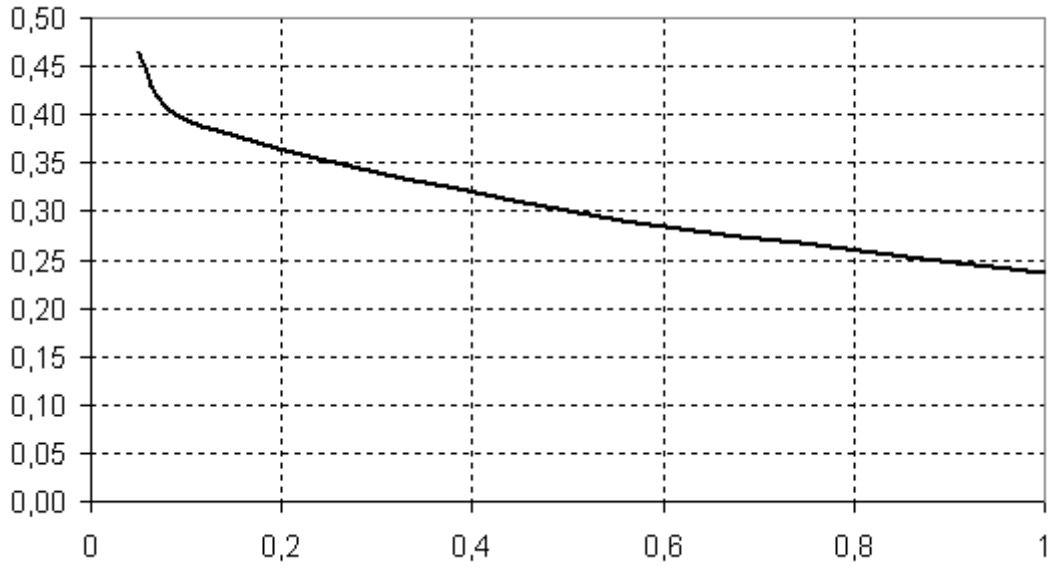

a680501049-phase-1a.bmp

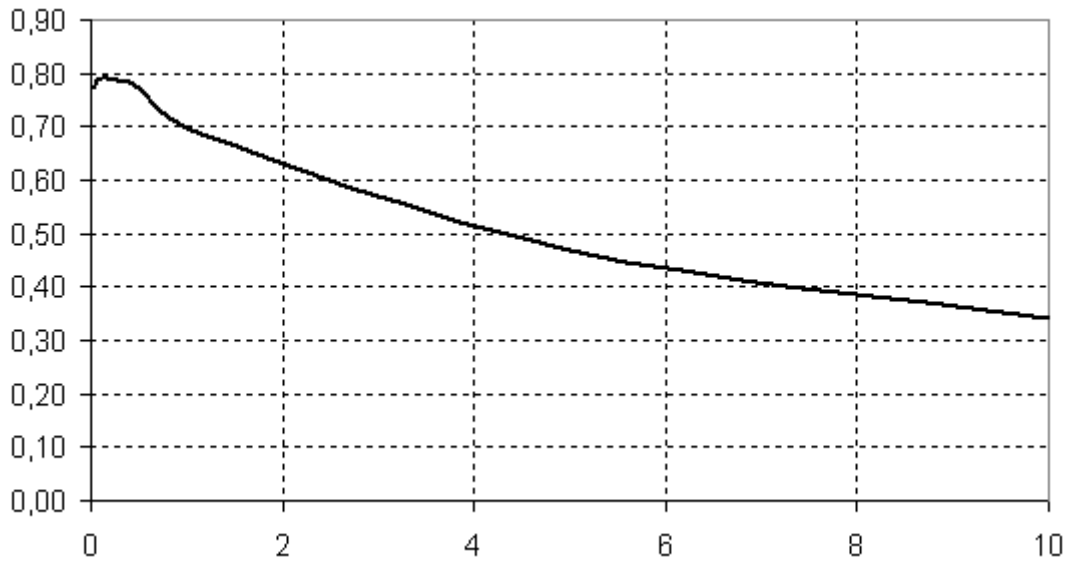

a680501049-phase-10a.bmp

Dimensions (in mm):

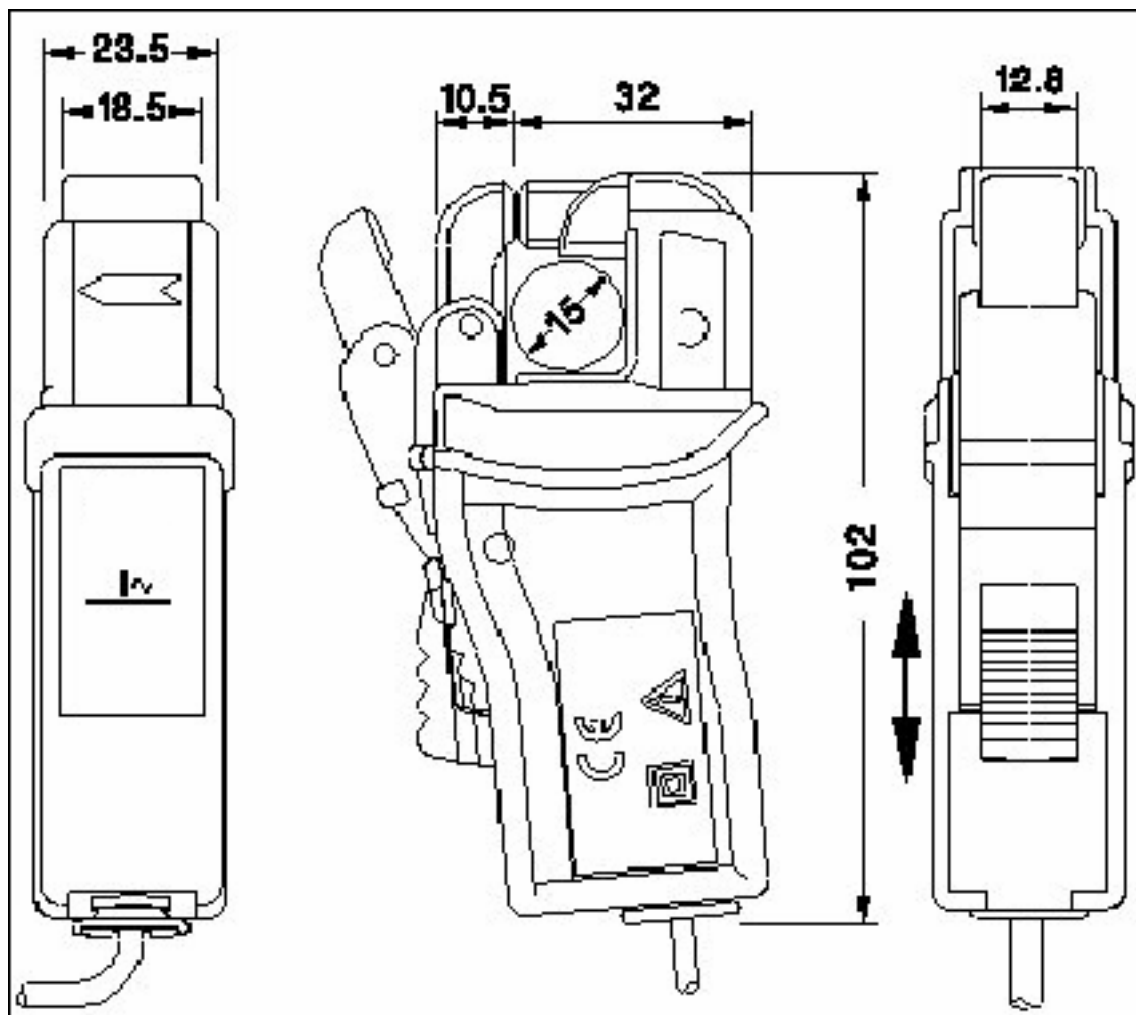

small clamp-dimensions.bmp

### Current Clamp 5 A/50 A AC

This current probe has been designed for non intrusive, accurate measurements of small AC currents. Using the latest technologies (internal memory for calibration data) provides reliable current ranges from 0.05 A up to 50 A. The measurement range can be selected in the PQ Analyze software: *IAC5* or *IAC50*.

#### **⚠ ⚠ Warning**

**To protect against electrical shock:**

- Utilize the clamps only on insulated conductors, max. 600 V rms or dc to ground.
- Use personal protective equipment measures as required by local government agencies, when attaching clamps to live circuits.

### Electrical Characteristics

Nominal current In:	5 A/50 A AC rms
Measuring ranges:	0.05 A – 5 A or 0.5 A – 50 A



Crest factor:	< 3
Peak current:	18 A, 180 A
Max. non destructive current:	Up to 200 A rms
Conductor position influence:	< 0.5 % of range at 50/60 Hz
Error due to adjacent conductor:	≤ 15 mA/A at 50 Hz
Phase error (to reference conditions):	< ±0.5 degrees
Frequency range (clamp without the instrument):	40 Hz – 10 kHz (–3 dB)
Temperature coefficient:	0.015 % of range/ °C
Safety:	300 V AC CAT IV, type C sensor, pollution degree 2

### General Characteristics

Maximum conductor size:	<i>Diameter:</i> 15 mm. <i>Bus bar:</i> 15 x 17 mm
Cable length:	2 m
Operating temperature range:	–10 °C - +55 °C
Storage temperature range:	–20 - +70 °C
Operating humidity:	15 % - 85 % (non-condensing)
Weight (per clamp):	Approx. 220 g
Order-number:	2540461

### Reference Conditions

Environment temperature range:	+18 °C to +26 °C
Humidity:	20 to 75 % rh
Current:	Sinusoidal waveform, with 48 to 65 Hz
Distortion factor:	< 1 %, no DC component, stray field < 40 A/m, conductor centered within the clamp jaws

### Safety Standards

- IEC/EN 61010-1 2<sup>nd</sup> edition
- IEC/EN 61010-2-032
- IEC/EN 61010-031

### EMC Standards

EN61326 –1:2006

### Accuracy (Typical, for 50/60 Hz)

Linearity, error in % of measured value, primary current in A:

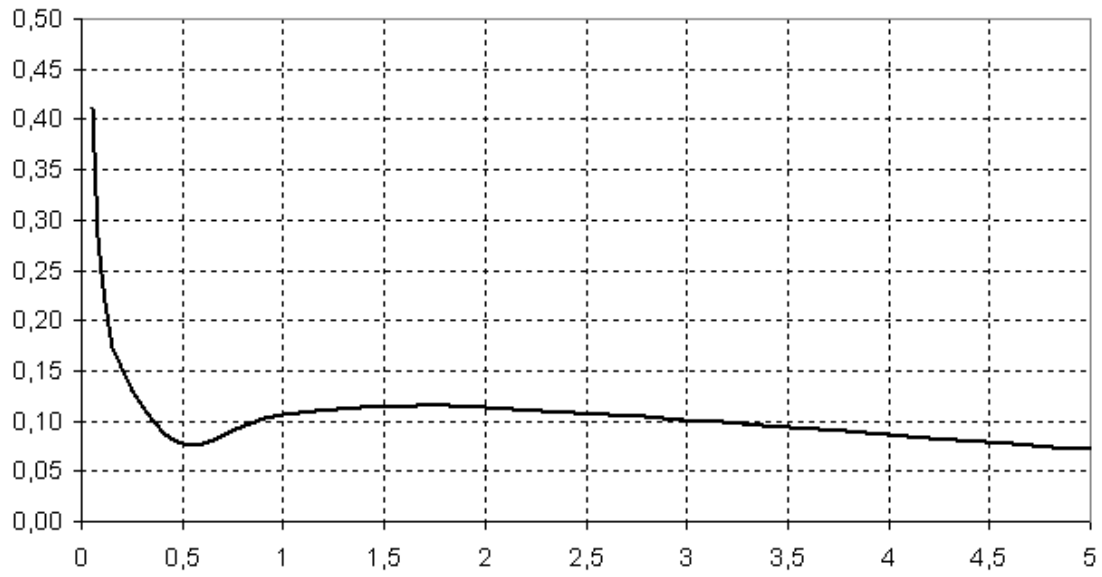

a680501048-linearity-5a.bmp

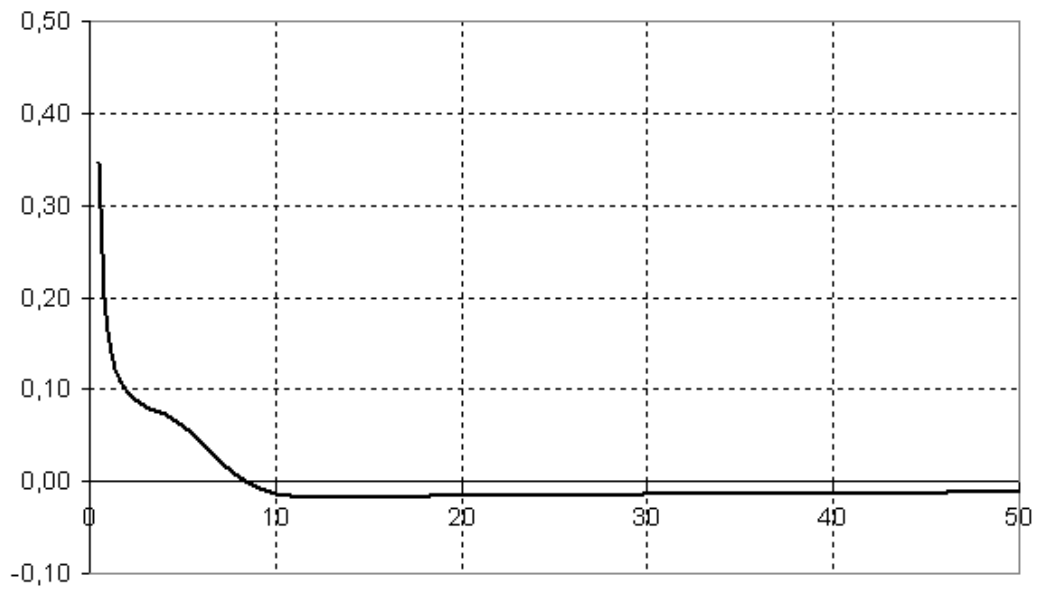

a680501048-linearity-50a.bmp

Phase angle in degrees, primary current in A:

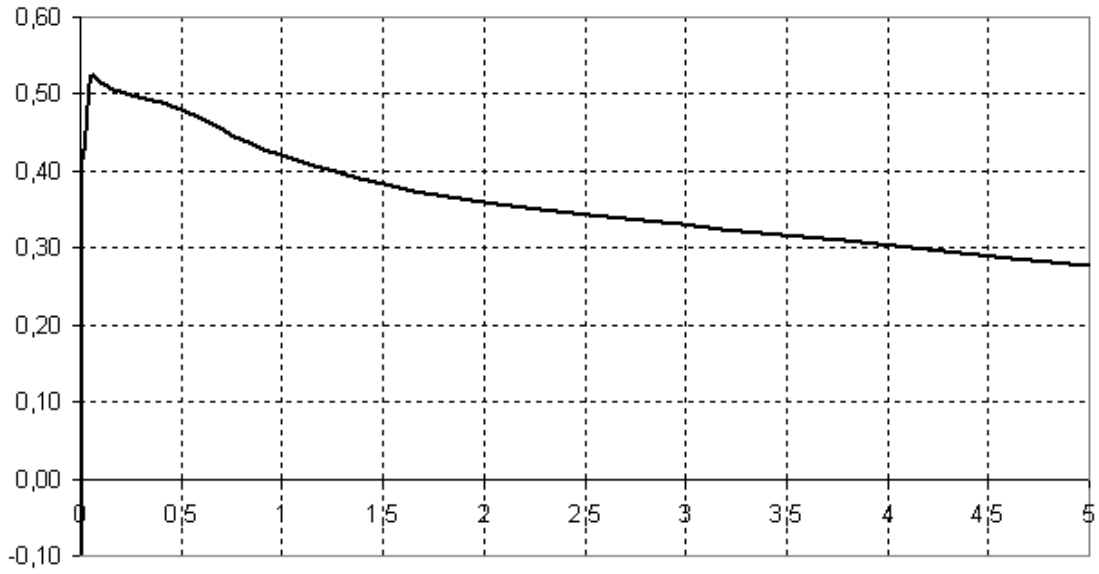

a680501048-phase-5a.bmp

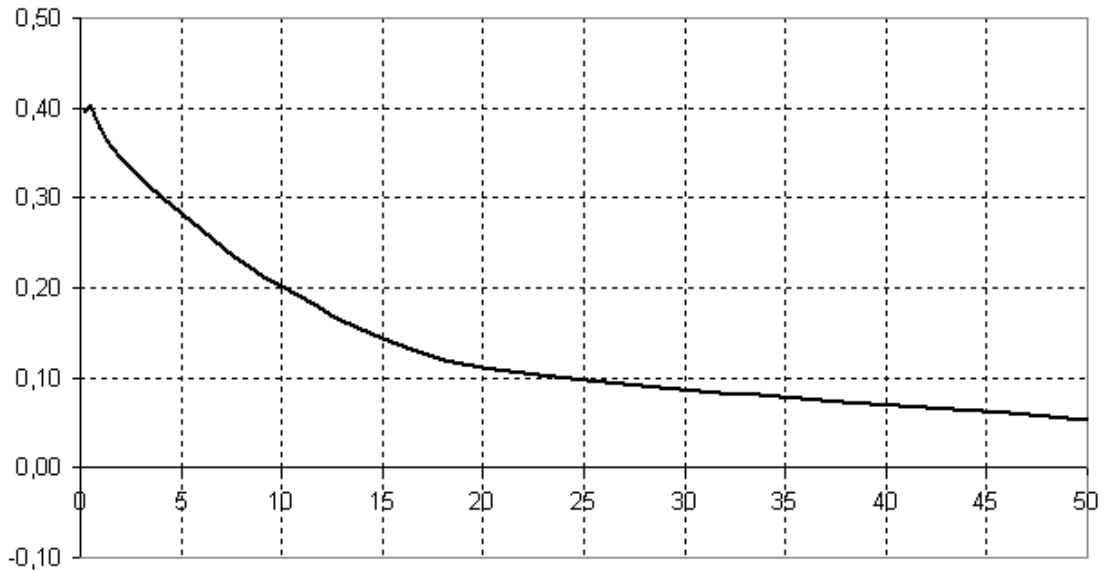

a680501048-phase-50a.bmp

Dimensions: See 2540445 (1 A/10 A Current Clamp).

### Current Clamp 20 A/200 A AC

This current probe has been designed for non intrusive, accurate measurements of small AC currents. Using the latest technologies (internal memory for calibration data) provides current ranges from 0.2 A up to 200 A. The measurement range can be selected in the PQ Analyze software: *IAC20* or *IAC200*.

#### Warning

To protect against electrical shock:

- Utilize the clamps only on insulated conductors, max. 600 V rms or dc to ground.
- Use personal protective equipment measures as required by local government agencies, when attaching clamps to live circuits.

### Electrical Characteristics

Nominal current In:	20 A, 200 A AC rms
Measuring ranges:	0.2 A – 20 A or 2 A – 200 A
Crest factor:	< 3
Peak current:	74 A, 300 A
Max. non destructive current:	Up to 300 A rms
Conductor position influence:	< 0.5 % of range for 50/60 Hz
Error due to adjacent conductor:	≤15 mA/A for 50 Hz
Phase error (to reference conditions):	< ±0.5 degrees
Frequency (clamp without the instrument):	40 Hz – 10 kHz (–3 dB)
Temperature coefficient:	0.015 % of range/ °C
Safety:	300 V CAT IV, type C sensor, pollution degree 2

### General Characteristics

Maximum conductor size:	<i>Diameter:</i> 15 mm <i>Bus bar:</i> 15 x 17 mm
Cable length:	2 m
Operating temperature range:	–10 °C - +55 °C
Storage temperature range:	–20 - +70 °C
Operating humidity:	15 % - 85 % (non-condensing)
Weight (per clamp):	Approx. 220 g
Order-number:	2540450

### Reference Conditions

Environment temperature range:	+18 °C to +26 °C.
Humidity:	20 up to 75 % r.h.

Current:	Sinusoidal waveform with 48 to 65 Hz.
Distortion factor:	< 1 %, no DC component, stray field < 40 A/m, conductor centered within the clamp jaws

### **Safety Standards**

- IEC/EN 61010-1 2<sup>nd</sup> edition
- IEC/EN 61010-2-032
- IEC/EN 61010-031

### **EMC Standards**

EN61326 –1:2006

### **Accuracy (Typical, for 50/60 Hz)**

Linearity, error in % of measured value, primary current in A:

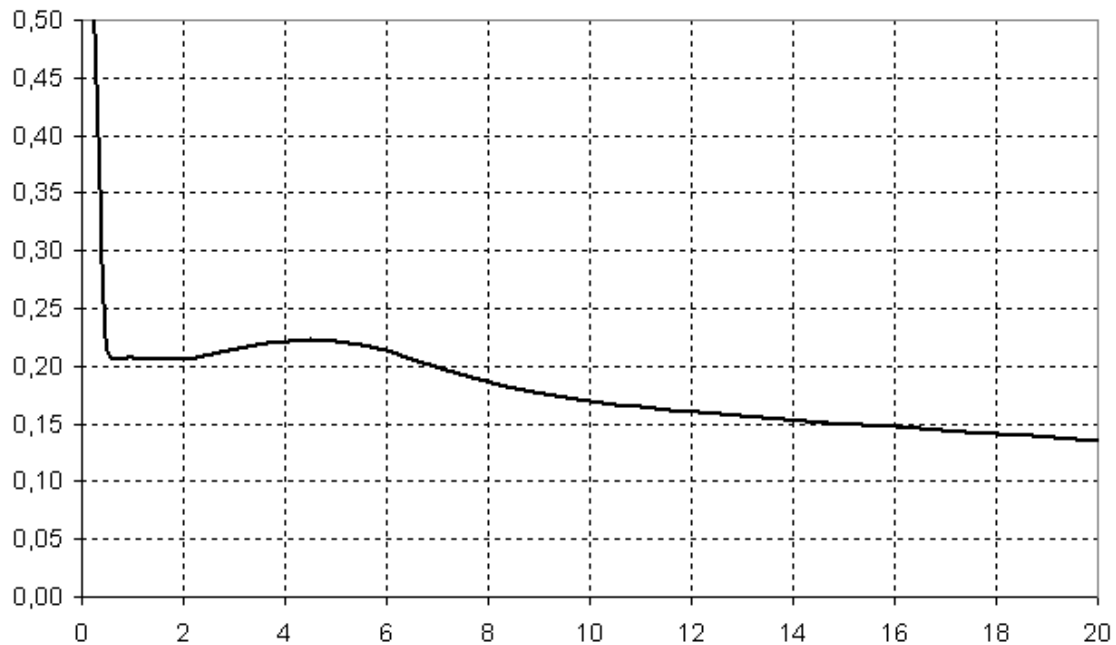

a680501050-linearity-20a.bmp

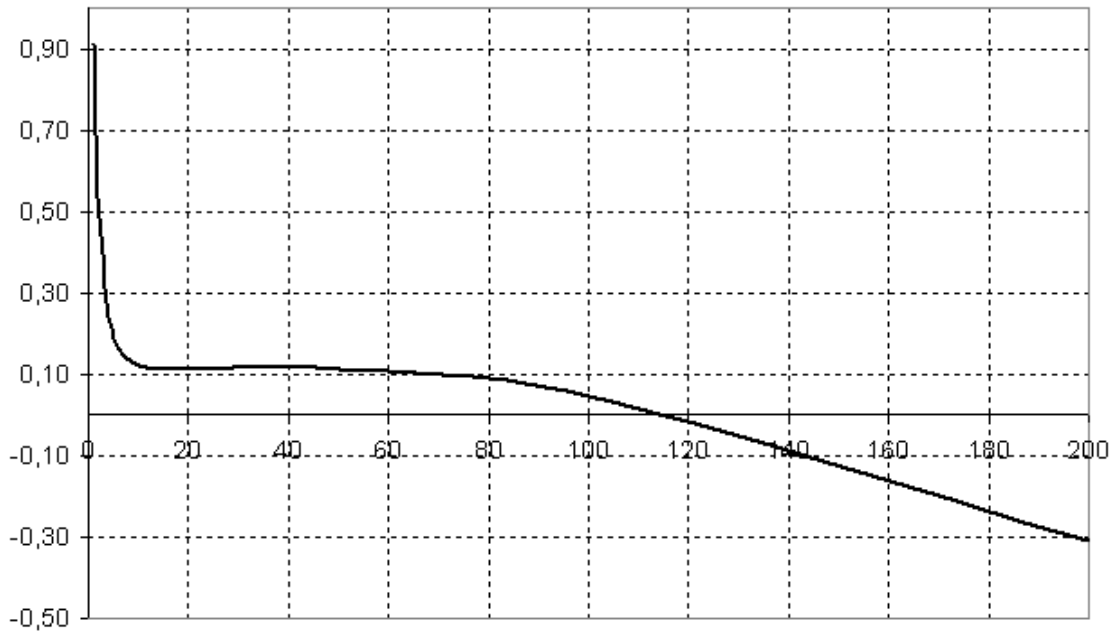

a680501050-linearity-200a.bmp

Phase angle in degrees, primary current in A:

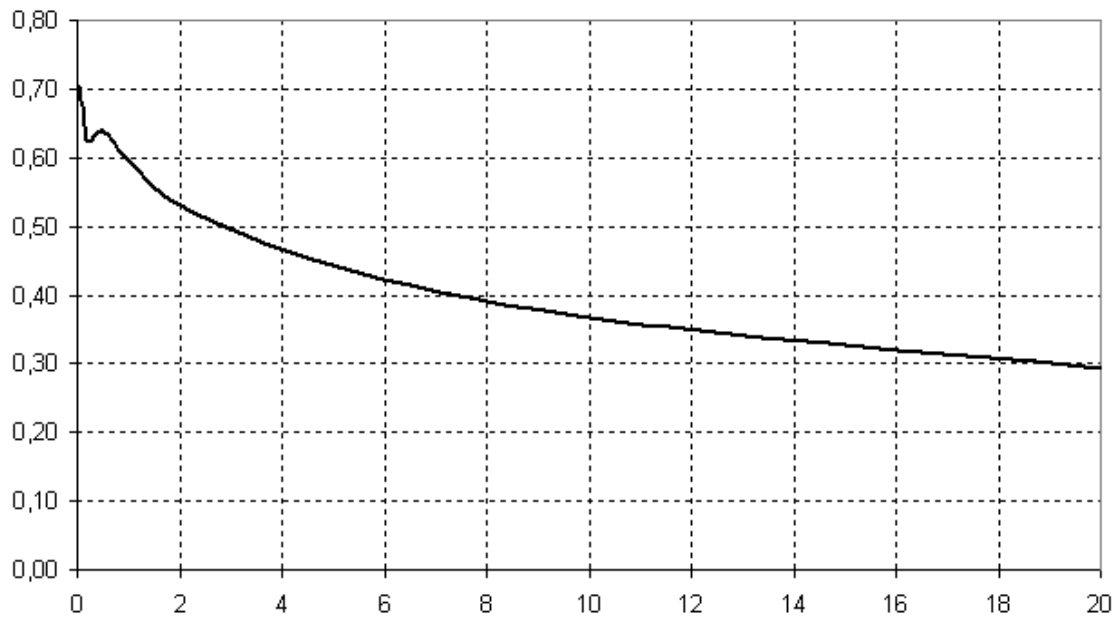

a680501050-phase-20a.bmp

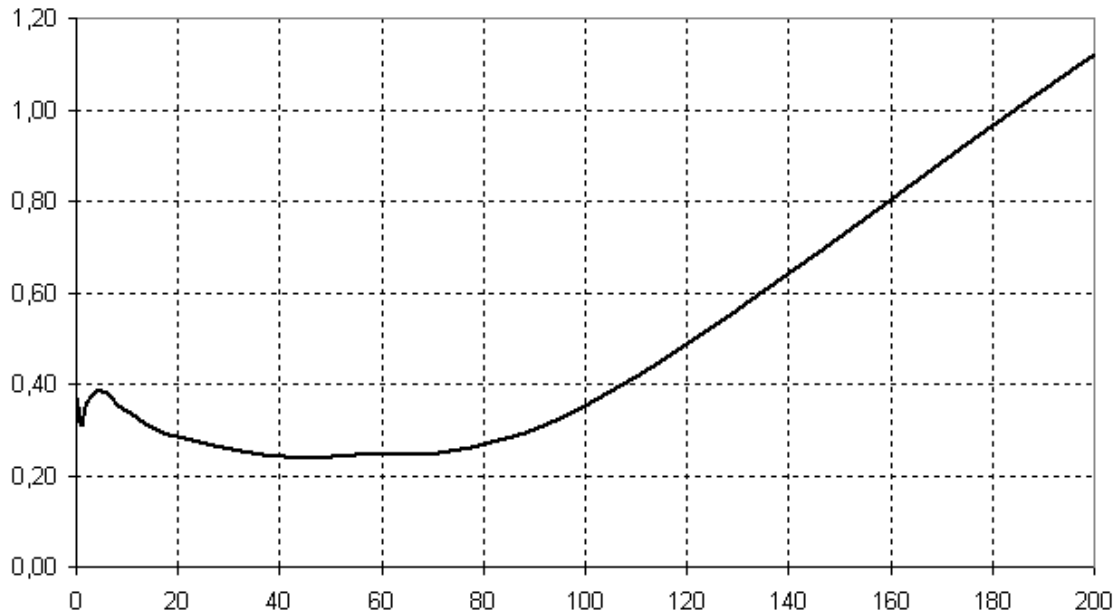

a680501050-phase-200a.bmp

Dimensions: See 2540445.

### **Flexi Current Sensor 100 A/500 A**

This current probe has been designed for non intrusive, accurate AC current measurements. Using the latest technologies (internal memory for calibration data) provides current measurements between 1 A and 500 A. The measurement range can be selected in the PQ Analyze software: *IAC100* or *IAC500*.

#### **⚠️ ⚠️ Warning**

**To protect against electrical shock:**

- **Utilize the clamps only on insulated conductors, max. 600 V rms or dc to ground.**
- **Use personal protective equipment measures as required by local government agencies, when attaching clamps to live circuits.**

### **Electrical Characteristics**

Nominal current $I_n$ :	100 A, 500 A AC rms
Measuring ranges:	1 A – 100 A or 5 A – 500 A AC
Peak current:	240 A, 1350 A
Overload capacity:	Up to 2000 A rms
Intrinsic error:	$< \pm 1$ % of mv
Linearity (10 % - 100 % of $I_n$ ):	$\pm 0.2$ % of $I_n$ .
Conductor position influence:	$< \pm 2$ % of mv, distance to measuring head >30 mm
Error due to adjacent conductor:	$\leq \pm 2$ A (Iext = 500 A, distance to head >200 mm)

Phase error (to reference conditions):	< $\pm 0.5$ degrees
Temperature coefficient:	0.005 % of range/ °C
Safety:	600 V CAT IV, type B sensor, pollution degree 2

### *General Specification*

Cable length:	2 m
Length of measuring head:	45 cm (18 inch)
Operating temperature range:	-10 °C - +70 °C
Storage temperature range:	-20 °C - +90 °C
Operating humidity:	10 % - 80 % (non-condensing)
Weight:	Approx. 220 g
Order-number:	2540477

### *Reference Conditions*

Environment temperature range:	+18 °C to +26 °C
Humidity:	20 – 75 % rh
Current:	Nominal value $I_n$ , sinusoidal waveform, 48 – 65 Hz
Distortion factor:	< 1 %. No DC component, stray field < 40 A/m, conductor centered within the Flexi current sensor

### *Safety Standards*

- IEC/EN 61010-1 2<sup>nd</sup> edition
- IEC/EN 61010-2-032
- IEC/EN 61010-031

### *EMC Standards*

EN61326 –1:2006

### *Accuracy (Typical, for 50/60 Hz)*

Linearity, error in % of measured value, primary current in A:



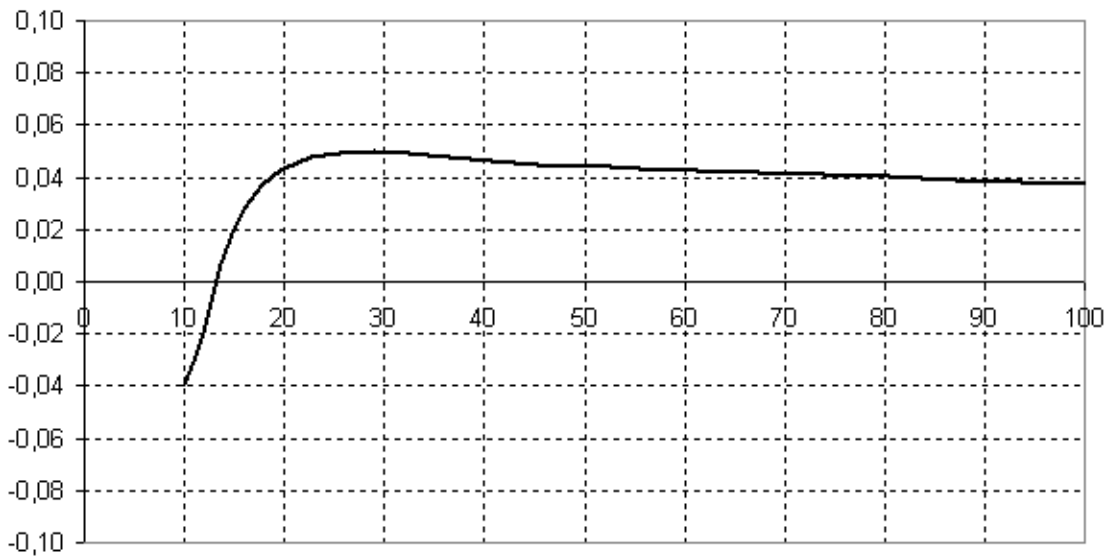

ep1205-linearity-100a.bmp

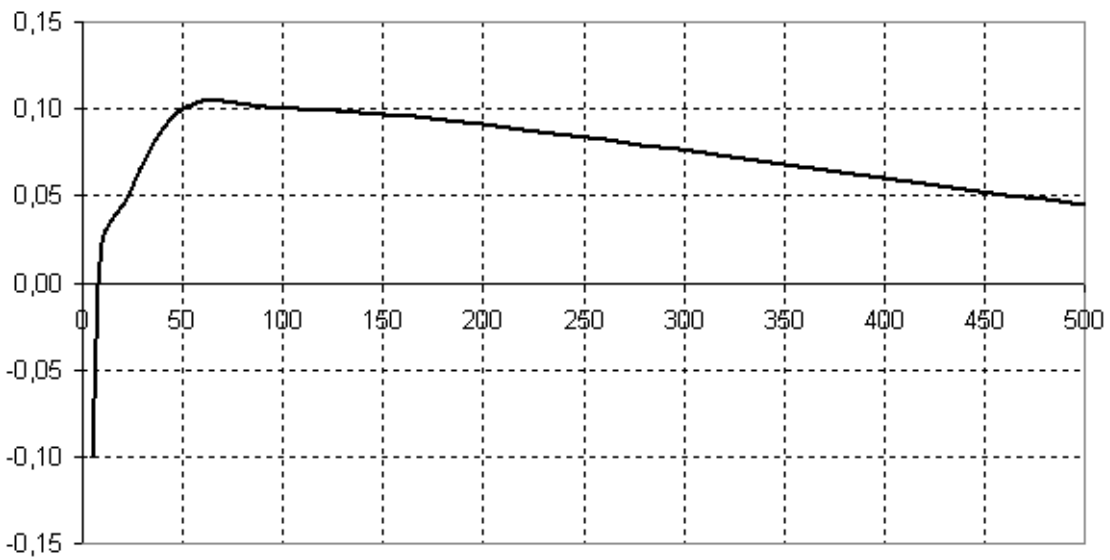

ep1205-linearity-500a.bmp

Phase angle in degrees, primary current in A:

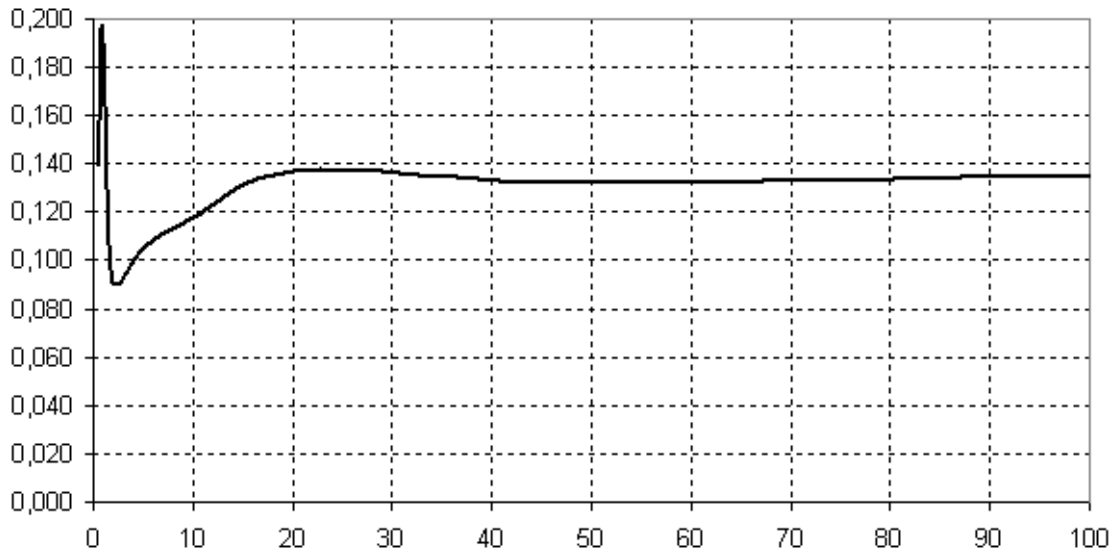

ep1205-phase-100a.bmp

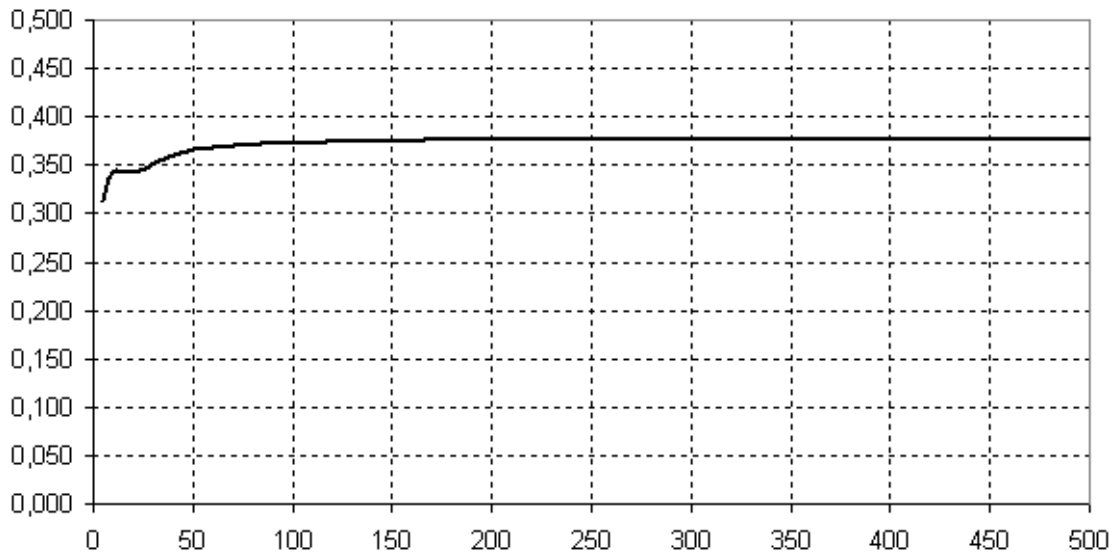

ep1205-phase-500a.bmp

**Flexi Current Sensor 200 A/1000 A**

This current probe has been designed for non intrusive, accurate ac current measurements. Using the latest technologies (internal memory for calibration data) provides current measurements between 2 A and 1000 A. The measurement range can be selected in the PQ Analyze software: *IAC200* or *IAC1000*.

**⚠ ⚠ Warning****To protect against electrical shock:**

- **Utilize the clamps only on insulated conductors, max. 600 V rms or dc to ground.**
- **Use personal protective equipment measures as required by local government agencies, when attaching clamps to live circuits.**

**Electrical Characteristics**

Nominal current In:	200 A, 1000 A AC rms
Measuring ranges:	2 A – 200 A or 10 A – 1000 A ac
Peak current:	480 A, 2700 A
Max. non destructive current:	Up to 2000 A rms
Intrinsic error:	< ±1 % of mv
Linearity (10 % - 100 % of In):	±0.2 % of In
Conductor position influence:	< ±2 % of mv, distance to measuring head >30 mm
Error due to adjacent conductor:	≤ ±2 A (I <sub>ext</sub> = 500 A, distance to head >200 mm)
Phase error (to reference conditions):	< ± 0.5 degrees
Temperature coefficient:	0.005 % of range/ °C
Safety:	600 V CAT IV, type B sensor, pollution degree 2

**General Specifications**

Cable length:	2 m
Length of measuring head:	61 cm (24 inch)
Operating temperature range:	-10 °C - +70 °C
Storage temperature range:	-20 °C - +90 °C
Operating humidity:	10 % - 80 % (non condensing)
Weight:	Approx. 220 g
Order-number:	2540489

**Reference Conditions**

Environment temperature range:	+18 °C to +26 °C
Humidity:	20 – 75 %

Current:	Nominal value $I_n$ , sinusoidal waveform, 48 – 65 Hz
Distortion factor:	< 1 %. No DC stray field <40 A/m, conductor centered within the Flexi current sensor

### Safety Standards

- IEC/EN 61010-1 2<sup>nd</sup> edition
- IEC/EN 61010-2-032
- IEC/EN 61010-2-031

### EMC Standards

EN61326 –1:2006

### **⚠ ⚠ Warning**

**To protect against electrical shock:**

- **Utilize the clamps only on insulated conductors, max. 600 V rms or dc to ground.**
- **Use personal protective equipment measures as required by local government agencies, when attaching clamps to live circuits.**

### Accuracy (Typical, for 50/60 Hz)

Linearity, error in % of measured value, primary current in A:

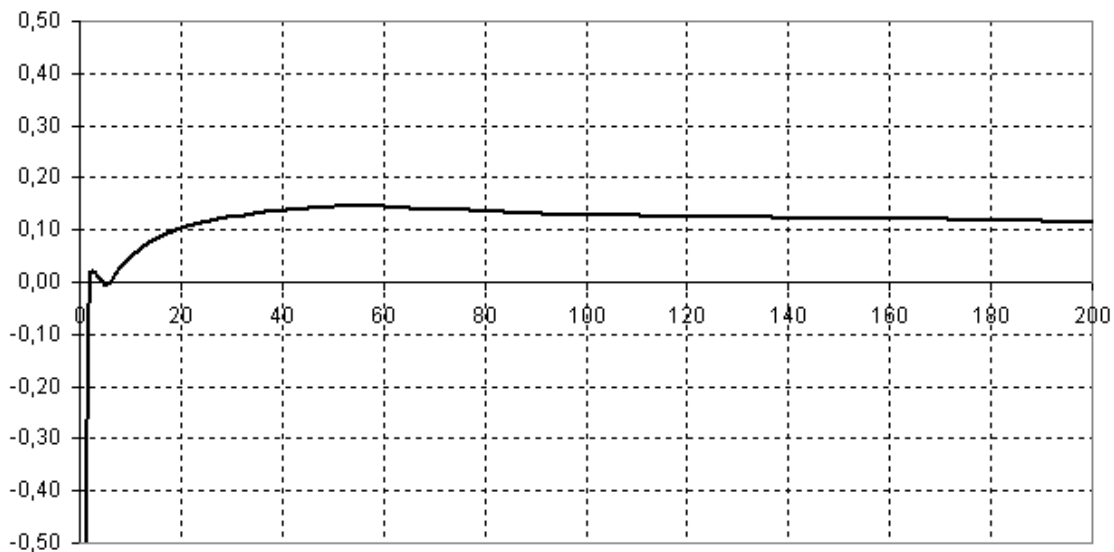

ep1210a-linearity-200a.bmp

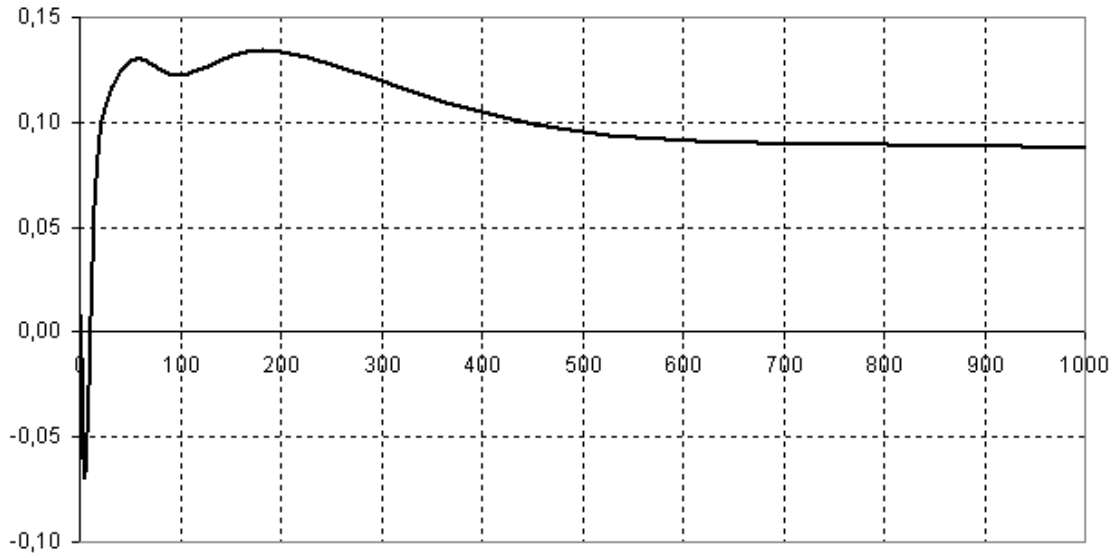

ep1210a-linearity-1000a.bmp

Phase angle in degrees, primary current in A:

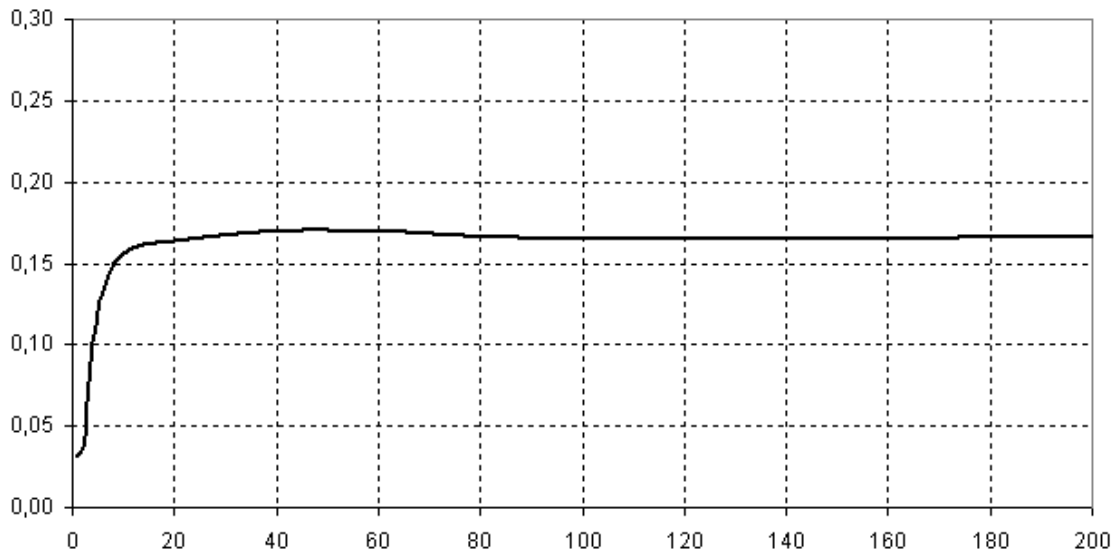

ep1210a-phase-200a.bmp

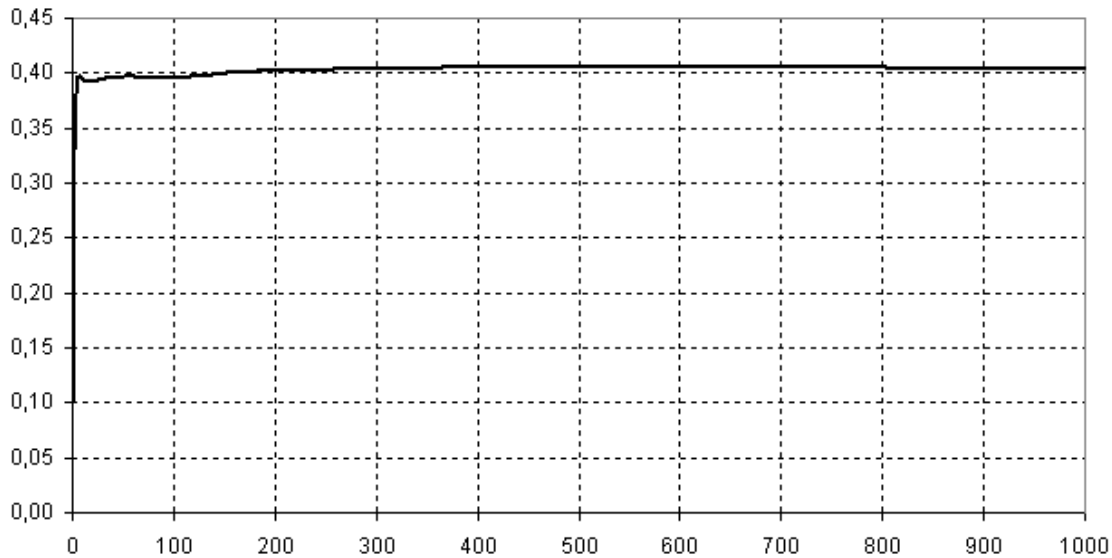

ep1210a-phase-1000a.bmp

### **Flexi Current Sensor 3000 A/6000 A**

This current probe has been designed for non intrusive, accurate ac current measurements. Using the latest technologies (internal memory for calibration data) provides current measurements between 30 A and 6000 A. The measurement range can be selected in the PQ Analyze software: *IAC3000* or *IAC6000*.

#### **⚠ ⚠ Warning**

##### **To protect against electrical shock:**

- **Utilize the clamps only on insulated conductors, max. 600 V rms or dc to ground.**
- **Use personal protective equipment measures as required by local government agencies, when attaching clamps to live circuits.**

##### Electrical Characteristics

Nominal current $I_n$ :	3000 A, 6000 A AC rms
Measuring ranges:	30 A ... 3000 A or 60 A ... 6000 A AC
Peak current:	10 kA, 19 kA
Max. non destructive current:	up to 19 kA rms
Intrinsic error:	$< \pm 2$ % of mv
Linearity (10 % - 100 % of $I_n$ ):	$\pm 0.2$ % of $I_n$
Conductor position influence:	$< \pm 2$ % of m.v, distance to measuring head >30 mm
Error due to adjacent conductor:	$\leq \pm 2$ A ( $I_{ext} = 500$ A, distance to head >200 mm)
Phase error (to reference conditions):	$< \pm 0.5$ degrees

Temperature coefficient:	0.005 % of range/ °C
Safety:	600 V CAT IV, type B sensor, pollution degree 2

### **General Characteristics**

Cable length:	4 m (156 inches)
Length of measuring head:	91 cm (36 inches)
Operating temperature range:	-10 °C - +70 °C
Storage temperature range:	-20 °C - +90 °C
Operating humidity:	10 % - 80 % (non condensing)
Weight:	Approx. 400 g
Order-number:	2540492

### **Reference Conditions**

Environment temperature range:	+18 °C to +26 °C
Humidity:	20 – 75 %
Current:	Nominal value $I_n$ , sinusoidal waveform, 48 – 65 Hz
Distortion factor:	<1 %. Stray field <40 A/m, conductor centered within the Flexi current sensor

### **Safety Standards**

- IEC/EN 61010-1 2<sup>nd</sup> edition
- IEC/EN 61010-2-032
- IEC/EN 61010-031

### **EMC Standards**

EN61326 –1:2006

### **Accuracy (Typical, for 50/60 Hz)**

Linearity, error in % of measured value, primary current in A:

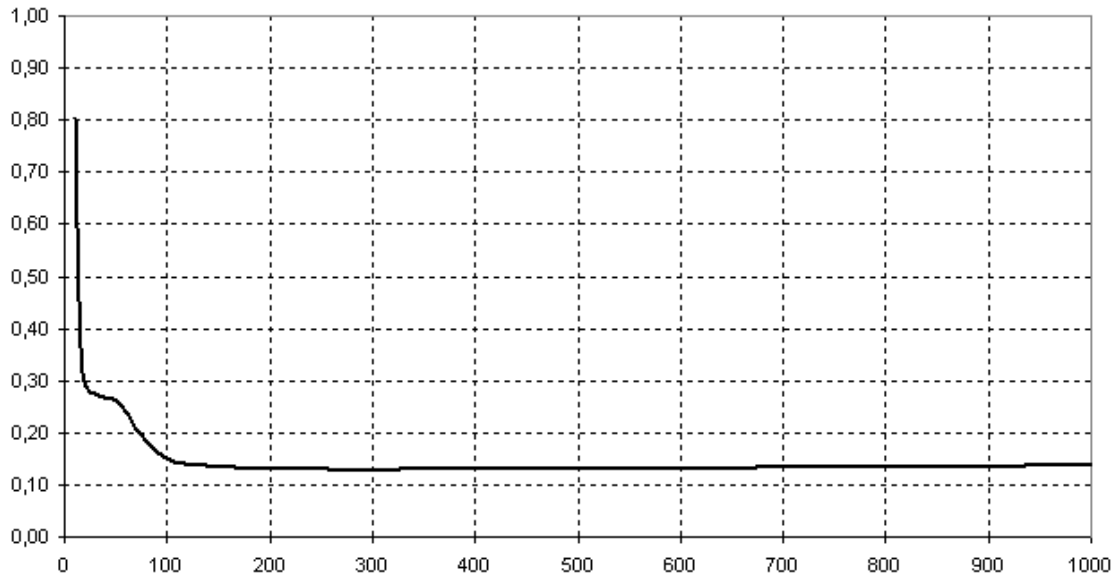

ep1360a-linearity.bmp

Phase angle in degrees, primary current in A:

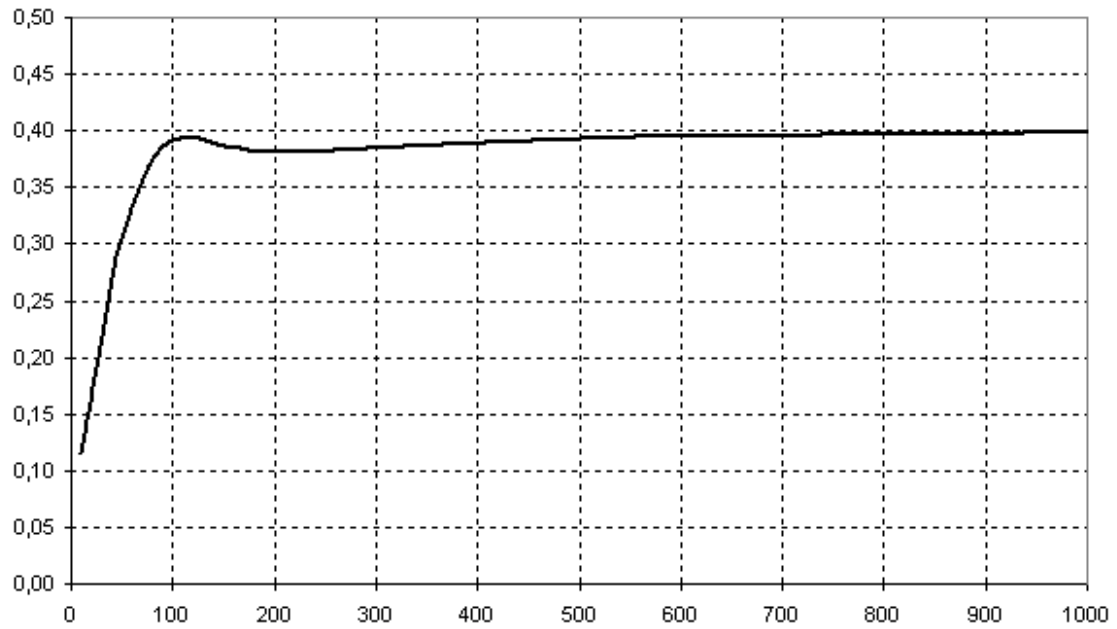

ep1360a-phase.bmp



## GPS-Time Synchronization Module Option

This option consists of a GPS-receiver module including GPS antenna, and a 5 m connection cable for the Instrument 25-pole feature connector (on top of the instrument).

### Note

*For optimal performance the GPS receiver should be placed in a location where at least 4 satellites are within the receiving area; concrete, metal construction elements and roofs may interfere with, and reduce the GPS signal level. An extension cable with 10 m length is available to enable positioning of the receiver in clear sight.*

### Technical Specification

Dimensions:	Diameter 61 mm (2.4 inch). Height: 19.5 mm (0.77 inch).
Weight:	Appr. 200 g. (0.4 lbs)
Cable length:	5 m. (16.5 ft)
Mounting:	Integrated magnetic base.
Case:	Polycarbonate thermoplastic.
Protection:	IPX7 as per IEC 60529.
Operating temp. range:	-30 °C - +80 °C.
Storage temp. range:	-40 °C - +90 °C.
Power consumption:	0.3 W typ.
Sensitivity:	-165 dBW.
Acquisition time:	Cold start: 45 s. Warm start: 15 s. Re-acquisition: 2 s.
Protocol:	NMEA 0183 V2.0, or V2.30. UTC (Coordinated Universal Time). PPS (pulse per second), rising edge.
Satellites:	Tracking of up to 12 satellites continuously.
Time accuracy:	Better than $\pm 1 \mu\text{s}$ at rising edge of pulse.
Memory:	Non volatile memory for storage of configuration data.
Part Number:	2539223

### Procedure:

1. Run the PQ Analyze software and open menu *Service – GPS Configuration*.

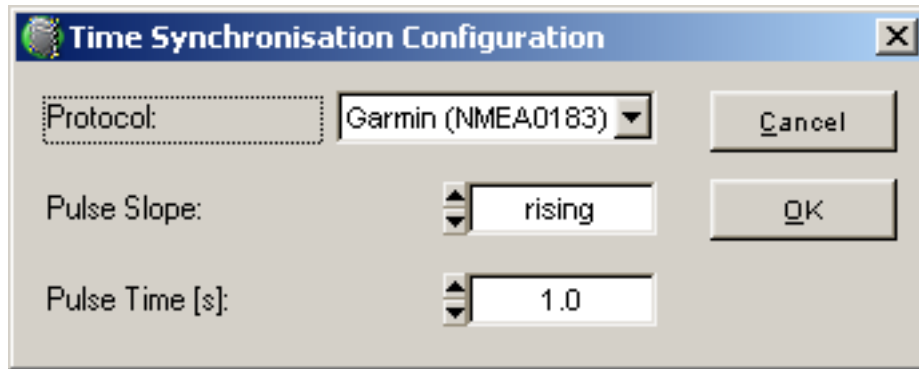

garmin-settings.bmp

2. Put the GPS receiver in a location with clear view to the sky.
3. Connect the GPS-receiver to the Instrument 25-pole feature connector on top.
4. Power on the Instrument. The instrument checks if there are NMEA data available. If *yes* it corrects the internal time. The internal time is taken for measurements.
5. The *Pulse* LED on the Instrument will start to blink at the reception of synchronization pulses. For LED functions see LEDs *Time Sync*.

### Handling of Date/Time in the Instrument

There are two ways for changing date/time:

- *Hard change*: Date/time (used for timestamps of measurement values) are set to the actual time immediately.
- *Soft change*: Measurement date/time are accelerated or decelerated by a small amount until the real-time is reached.

### Changing Date/Time: No Measurement is Active

When no measurement is running, then time changes by GPS or software are always performed immediately.

### Changing Date/Time during a Measurement

During a measurement only soft time changes can be done.

When the GPS signal becomes available during a measurement, then the *system time* is set immediately and the measurement time adapts slowly ( $\pm 0.01\%$ ) to the new system time. This provides a correction of max. 8.64 seconds per day. The error for the power frequency measurement is  $< 0.005$  Hz at 50 Hz and  $< 0.006$  Hz at 60 Hz (IEC61000-4-30 5.1.2 requires that the measurement uncertainty never exceeds  $\pm 0.01$  Hz).

If you need to carry out a “hard” date/time change of the instrument via the software then proceed as follows:

1. Download measurement data
2. Adjust date/time
3. Load current measurement settings: select Measurement-> Settings
4. Initialize a new measurement by pressing the Initialize button