

avrora-arm.ru  
+7 (495) 956-62-18

**SIMRAD**

**PRO**  
SERIES

# FU80, NF80, QS80

## User Guide

ENGLISH



# Preface

---

As Navico is continuously improving this product, we retain the right to make changes to the product at any time which may not be reflected in this version of the manual. Please contact your nearest distributor if you require any further assistance.

It is the owner's sole responsibility to install and use the equipment in a manner that will not cause accidents, personal injury or property damage. The user of this product is solely responsible for observing safe boating practices.

NAVICO HOLDING AS AND ITS SUBSIDIARIES, BRANCHES AND AFFILIATES DISCLAIM ALL LIABILITY FOR ANY USE OF THIS PRODUCT IN A WAY THAT MAY CAUSE ACCIDENTS, DAMAGE OR THAT MAY VIOLATE THE LAW.

Governing Language: This statement, any instruction manuals, user guides and other information relating to the product (Documentation) may be translated to, or has been translated from, another language (Translation). In the event of any conflict between any Translation of the Documentation, the English language version of the Documentation will be the official version of the Documentation.

This manual represents the product as at the time of printing. Navico Holding AS and its subsidiaries, branches and affiliates reserve the right to make changes to specifications without notice.

## Compliance statements

Simrad FU80, NF80 and QS80:

- meet the technical standards in accordance with Part 15.103 of the FCC rules
- comply with CE under EMC directive 2004/108/EC
- comply with the requirements of level 2 devices of the Radio communications (Electromagnetic Compatibility) standard 2008.

The relevant Declaration of Conformity is available in the following website under model documentation section:

[pro.simrad-yachting.com](http://pro.simrad-yachting.com) or [www.simrad-yachting.com](http://www.simrad-yachting.com).

## Copyright

Copyright © 2013 Navico Holding AS.

## Warranty

In case of any queries, refer to the website of your display or system.

# Contents

---

## **5 Introduction**

- 5 About this manual
- 5 Wheelmark approval
- 6 Parts included

## **7 Installation**

- 7 Mounting
- 9 Wiring
- 10 Configuring

## **11 Operation**

- 11 Basic operation - all remotes
- 14 Using the NF80
- 16 Using the FU80
- 18 Using the QS80
- 20 Changing commanded rudder direction
- 20 Alarms
- 21 Restoring factory settings
- 21 Maintenance

## **22 Changing default settings**

- 22 The main menu

## **23 Specifications**

- 23 Technical specifications
- 24 Drawings

# 1

## Introduction

### About this manual

This manual describes how to install and use the FU80, NF80 and the QS80 remotes.

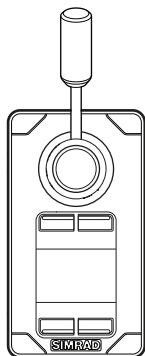

**NF80**

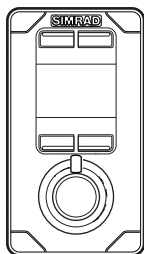

**FU80**

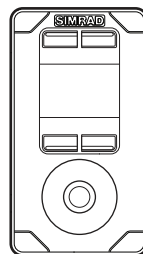

**QS80**

These remotes can be used to remotely control the AP70, AP80, AP24, AP28 and AP60 autopilot systems. They can also be used to remotely operate the autopilot function in NSE, NSS and NSO (Simrad Multifunction Displays).

→ **Note:** It is not possible to use FU80 with an AP24/28 operating on VRF (Virtual Rudder Feedback).

For detailed description of operational modes, see the Operator manual for your autopilot system or for your NSE/NSO/NSS.

For details about installation of CAN bus or SimNet backbone, see the autopilot System Installation manual.

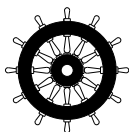

### Wheelmark approval

The remotes are produced and tested in accordance with the European Marine Equipment Directive 96/98 and can be used in a Wheelmark installation according to the certificates.

For details and certificates refer to our websites:

[pro.simrad-yachting.com](http://pro.simrad-yachting.com) and [www.simrad-yachting.com](http://www.simrad-yachting.com).

## Parts included

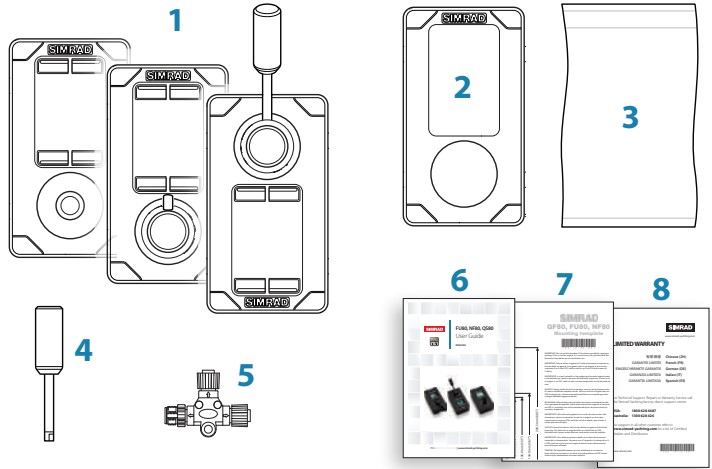

No.	Description
1	Remote unit, including 6 m (19.7 ft) Micro-C drop cable
2	Bezel
3	Bag including: <ul style="list-style-type: none"> <li>- Gasket for panel sealing</li> <li>- Mounting accessories</li> </ul>
4	Long type lever (FU80 and NF80)
5	Micro-C T-connector
6	User manual
7	Mounting template
8	Warranty card

# 2

## Installation

### Mounting

The remotes should be mounted with special regard to the units' environmental protection, temperature range and cable length. Refer "Technical specifications" on page 23.

- **Note:** If installed outdoors, select a position and a mounting option that prevents water from remaining on the display. It is recommended to cover the units when not in use.

### Panel mount

1. Attach the mounting template to the selected position
2. Drill fastening holes and remove the cut-out
3. Peel backing off the gasket (A) and apply it to the remote or to the mounting surface
4. Place the remote into the console
5. Secure the unit with the 4 screws (B)
6. Clip the bezel (C) in place.

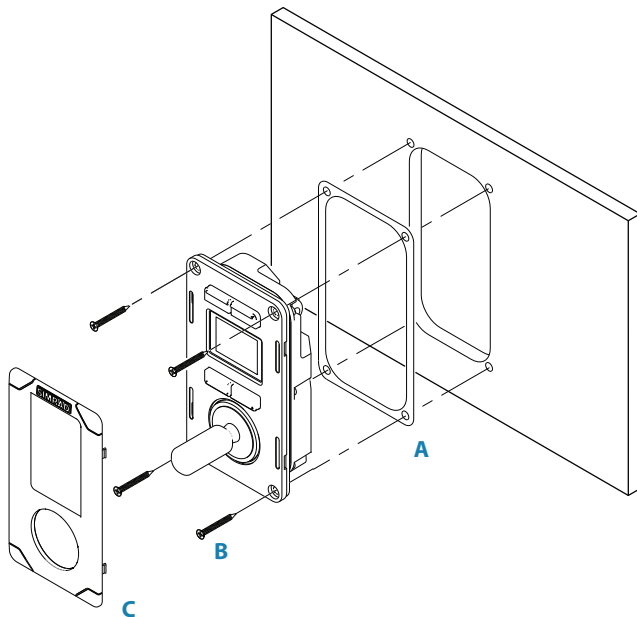

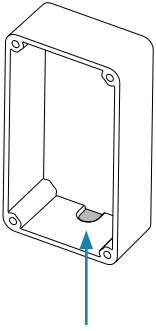

### The bulkhead frame

An optional bulkhead frame is available.

For part number, refer to our websites

([pro.simrad-yachting.com](http://pro.simrad-yachting.com) and [www.simrad-yachting.com](http://www.simrad-yachting.com))

1. Attach the mounting template to the selected position
2. Drill fastening holes
3. Drill hole for the cable, or remove the material in the cable entry area on the frame
4. Peel backing off the gaskets (A) and apply one to the remote, and the other to the sealing frame (D)
5. Secure the unit with the 4 screws (B)
6. Clip the bezel (C) in place.

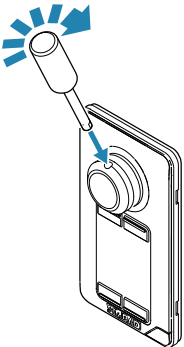
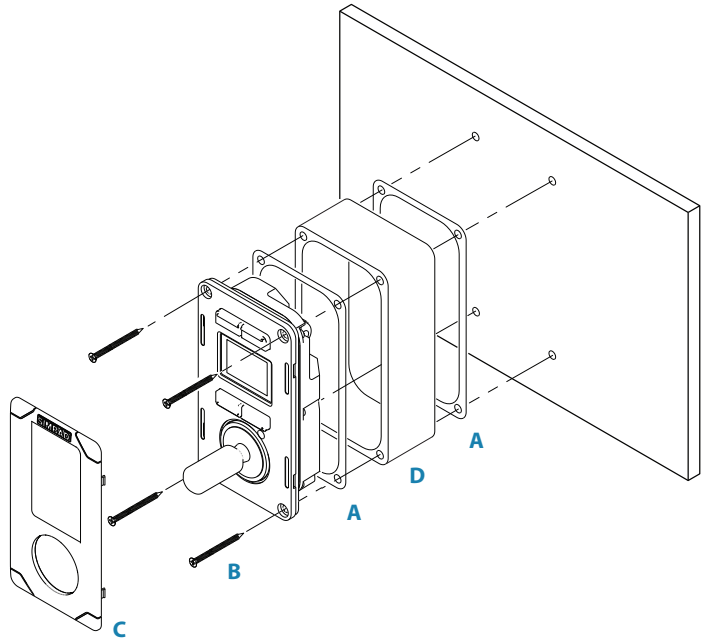

### The NF80 lever

The lever is not mounted from factory. Screw the lever firmly into the mounting hole.

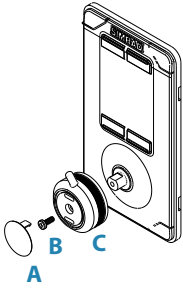

## The FU80 lever

The factory mounted short lever can be replaced by the longer lever included in the package.

The lever can be mounted in a 180° opposite direction as follows:

1. Remove the knob's cap (A)
2. Remove the screw (B), and carefully remove the knob (C)
3. Rotate the knob 180°, install the selected lever, re-install the knob and the cap .

## Wiring

- **Note:** Don't make sharp bends in the cables, and avoid running cables in a way that allows water to flow down into the connectors. If required, make drip and service loops.

The remotes connect to the CAN bus backbone or SimNet backbone as shown below.

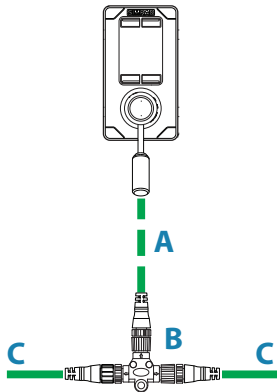

*AP60/AP70/AP80 system*

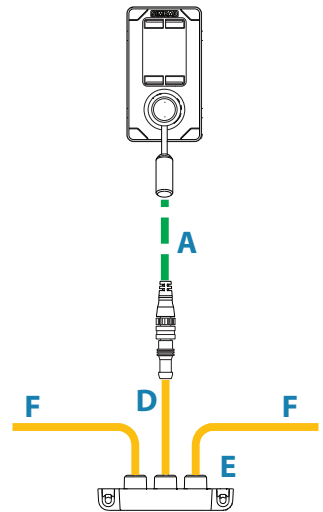

*AP24/AP28/NSE/NSS/NSO systems*



For part numbers, refer to our website.



Item	Component	
A	Micro-C drop cable, 6 m (19.7 ft)	Included with the unit
B	Micro-C T-connector	
C	CAN-bus backbone	
D	SimNet to Micro-C (female) cable, 0.5 m (1.64 ft)	
E	SimNet T-joiner (3p) or SimNet Multijoiner (7p)	
F	SimNet backbone	

## Configuring

The remotes are plug-and-play units, and no specific configuration is required unless you want to change SimNet group settings.

- **Note:** If the remotes are installed in a system with an AC12/AC12N or an AC42/AC42N computer, the **Alarms** and **Sources** SimNet groups must be changed from default value (100) to 1. Note that the value defaults to 100 also after a reset.

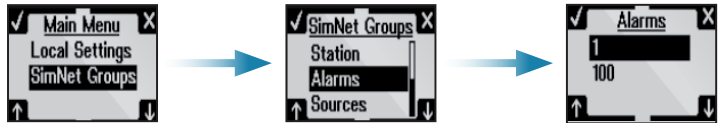





# 3

## Operation

### Basic operation - all remotes

#### The keys

Key	Short press	Long press (3 seconds)
	Take/request command	Activates/deactivates thrusters *
	Adjust illumination	Toggles day and night display illumination
	Turn the autopilot system to <b>Standby</b> mode	
	Toggle between available modes	Displays the Main menu ( <b>Standby</b> mode only)

- \* Only available in AP60, AP70 and AP80 systems. The thrusters must be available for autopilot steering in active steering profile. See the autopilot's Operator manuals for more information.









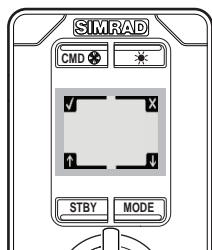

A long press is indicated with a progress bar. Keep the key pressed until all segments are filled.

#### Softkeys

When the menu is active or when an alarm message is displayed, the small icons below and above the keys indicate the function of the key.



Softkey	Key	Function
		OK/Accept/Acknowledge alarm
		Cancel/Return to previous menu level
		Mute alarm
		Move upwards in menu
		Move downwards in menu

## The screen

The upper part of the screen shows information relevant for the autopilot mode as shown below.

<i>Standby</i>	<i>NFU</i>	<i>FU</i>
<ul style="list-style-type: none"> <li>- Active heading sensor</li> <li>- Heading (True or Magnetic)</li> <li>- Current heading</li> </ul>		<ul style="list-style-type: none"> <li>- Commanded rudder angle</li> </ul>

<i>AUTO</i>	<i>NoDrift</i>	<i>NAV</i>	<i>WIND</i>
<ul style="list-style-type: none"> <li>- Set heading</li> </ul>	<ul style="list-style-type: none"> <li>- Set course</li> <li>- Course Over Ground (COG)</li> </ul>	<ul style="list-style-type: none"> <li>- Bearing to next waypoint</li> <li>- Cross track distance (XTD), analog and graphical</li> </ul>	<ul style="list-style-type: none"> <li>- Set wind angle</li> <li>- Current wind angle</li> </ul>

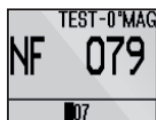

← The bar in the lower part of the screen always indicate current rudder position.

## Status icons

The remote's operational state is indicated with icons.

Icon	Status	Description
	Active	In operation
	Passive	The autopilot is operated from another control unit
	Locked	The autopilot is operated from another control device and this device is locked

## Switching from automatic to manual steering

Press the **STBY** key on active remote to switch the system from automatic mode to **Standby** mode.

If a menu or dialog is open, you must press and hold the **STBY** key to switch to **Standby** mode.

## Turning the unit on/off

The remote units have no power key, and will be on as long as connected to a powered CAN-bus/SimNet backbone.

If the autopilot system is turned off from an autopilot control unit, the remotes will go to sleep mode. In this mode the display will be black, and it is not possible to use the keys or the lever.

You can turn on a sleeping autopilot system by pressing the light key on a remote unit.

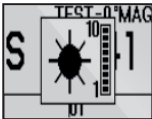

## Light adjustment

A single press on the light key will display the light adjustment dialog. Repeated short presses cycles through the brightness levels (0 - 10). The selection times out after 2 seconds.

A night mode which optimizes the color palette for low light conditions, is included. You switch between day and night illumination by pressing and holding the light key.

White is the default background color on display and keys for day illumination, while red is used for night. Refer "Changing default settings" on page 22.

- **Note:** The brightness level is adjusted independently for day and night modes.

## Activating/de-activating thrusters

If thrusters are available for autopilot control, you toggle the thrusters on and off by pressing and holding the **CMD** key.



Active thrusters are indicated with thruster icon in the display.

- **Note:** Only available in AP60, AP70 and AP80 systems. The thrusters must be available for autopilot steering in active steering profile.

## Taking command

Take command by pressing the **CMD** key. When command is transferred, the autopilot system will remain in current mode.

In an open system (no command transfer restrictions), you will get immediate control on the remote unit requesting command.

In a multi-station system with active lock function, the command request must be confirmed on the active control unit before you can use the remote.

For more information about multi-stations, see the Operator Manual for your autopilot system.

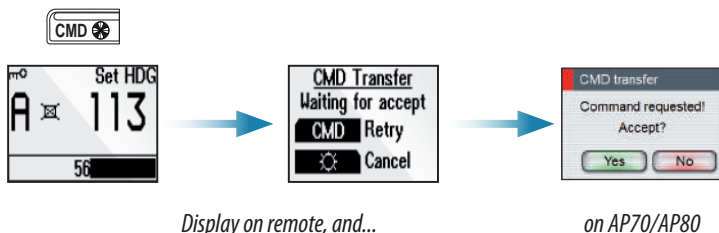

## Using the NF80

The NF80 lever has a mechanical spring that will return the lever to the mid-position when the lever is released.

You can use the NF80 in **NFU**, **AUTO** and **NoDrift** mode.

You can also get command if the system is in **FU**, **NAV** or **Wind** mode, but you cannot operate these modes from the NF80.

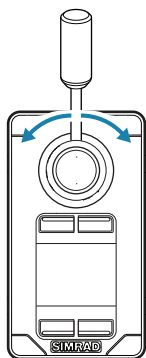

Initial mode	Lever moved / Resulting mode (action)
Standby	
NFU	NFU (rudder command)
FU	
AUTO	AUTO (heading change)
NoDrift	NoDrift (course change)
NAV	No action (warning sound and information dialog)
Wind	

➔ **Note:** The **Wind** mode is not available for AP60, AP70 or AP80 systems.

If the mode is available on other autopilot systems, the mode can only be used if the system is set up for sailboat. See the Installation manual for your system.



## Mode selection

You toggle between available modes by repeatedly pressing the **MODE** key. The selection times out and triggers the mode shift.

When in any other mode than **NFU**, the first press on the **MODE** key will turn the system to **NFU** mode.

You switch to **Standby** from any mode by pressing the **STBY** key.

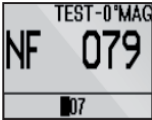

## Non-follow up steering

In this mode you use the lever to move the rudder. The rudder will move in the same direction as the lever, and will move as long as the lever is moved from mid-position.

→ **Note:** See "Changing commanded rudder direction" on page 20.

## Auto and NoDrift mode

When you select **AUTO/NoDrift** mode, the system will continue on the heading/course read from the sensors the very moment you selected the mode.

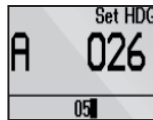

*Auto mode*



*NoDrift mode*

## Changing set heading/set course

Use the lever to change set heading in **AUTO** mode and set course in **NoDrift** mode. The value will change 1° each time the lever is pressed to left or right. If you keep the lever pressed, the value automatically changes at a rate of 5° per second. Each beep indicates a 1° change.

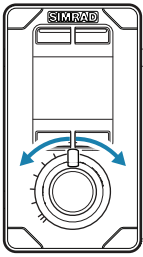

## Using the FU80

The FU lever can be rotated 70° to port and starboard from mid-position. The lever will remain in set position, and the commanded rudder angle/heading change maintained until the lever is returned to mid-position.

You can use the FU80 in **FU**, **AUTO** and **NoDrift** mode.

You can also get command if the system is in **NFU**, **NAV** or **Wind** mode, but you cannot operate these modes from the FU80.

Initial mode	Lever moved / Resulting mode (action)
Standby	No action
NFU	No action
FU	FU (rudder command)
AUTO	AUTO (heading change)
NoDrift	NoDrift (course change)
NAV	No action
Wind	

→ **Note:** The **Wind** mode is not available for AP60, AP70 or AP80 systems.

If the mode is available on other autopilot systems, the mode can only be used if the system is set up for sailboat. See the Installation manual for your system.

### Mode selection

You toggle between available modes by repeatedly pressing the **MODE** key. The selection times out and triggers a mode shift.

When in any other mode than **FU**, the first press on the **MODE** key will turn the system to **FU** mode.

You switch to **Standby** from any mode by pressing the **STBY** key.

→ **Note:** It is not possible to use FU80 with an AP24/28 operating on VRF (Virtual Rudder Feedback).





## Follow-up steering

In **FU** mode you use the lever to set the commanded rudder angle.

**⚠ Warning:** To avoid unintended rudder movement you should observe the lever position (commanded rudder angle) before activating the **FU** mode!

To increase resolution on small rudder angle commands, the relation between the lever rotation and the commanded rudder angle is non-linear. When the lever is rotated 20° from mid-position the rudder will be commanded 5° to port or starboard. A 65° lever angle will move the rudder to 40°. Max lever rotation will give max rudder angle. Refer your autopilot installation manual for how to set max rudder angle.

The rudder will remain in set position until a new rudder angle is commanded.

## AUTO and NoDrift mode

When you select **AUTO/NoDrift** mode, the system will continue on the heading/course read from the sensors the very moment you selected the mode.



*Auto mode*



*NoDrift mode*

## Changing set heading/set course

Use the lever to change set heading in **AUTO** mode and the set course in **NoDrift** mode. The value will change in steps defined by lever rotation, starting from 0.5°/second at 3° lever rotation, up to 5°/second at max lever rotation.



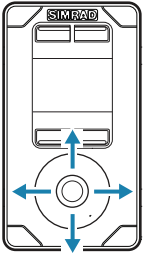

## Using the QS80

The QS80 stick has a mechanical spring that will return it to mid-position when the stick is released.

You can use the QS80 in **NFU**, **AUTO**, **NoDrift**, **NAV** and **Wind** mode.

→ **Note:** The **Wind** mode is not available for AP60, AP70 or AP80 systems.

If the mode is available on other autopilot systems, the mode can only be used if the system is set up for sailboat. See the Installation manual for your system.

## Mode selection

You toggle between available modes by repeatedly pressing the **MODE** key. The selection times out and triggers a mode shift.

You can also use the stick to change mode as shown in the table.



Initial mode	Stick movement / Resulting mode (action)		
	Up	Down	Left/Right
Standby	AUTO	Standby (center rudder)	NFU (rudder command)
NFU			
FU	Heading capture	Standby	Heading change
AUTO			Course change
NoDrift			No action
NAV			
Wind	AUTO		Adjust relative wind angle

## Non-follow up steering

When in **Standby** or **FU** mode, press the stick left or right to switch to **NFU** mode and to give rudder commands. The rudder will move as long as the stick is pressed.

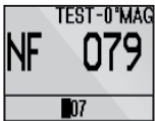

## Centering the rudder

A single downwards press on the stick while in **Standby** or **NFU** mode will command the rudder to mid-position. A short beep will sound when the rudder is centered.

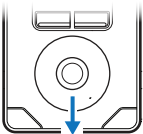

## Auto and NoDrift mode

When you select **AUTO/NoDrift** mode, the system will continue on the current heading/course the very moment you selected the mode.



Auto mode

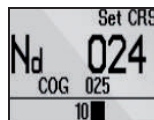

NoDrift mode

### Changing set heading/set course

Use the stick to change set heading in **AUTO** mode and the set course in **NoDrift** mode. The value will change 1° each time the stick is pressed to left or right. If you keep the stick pressed, the value automatically changes at a rate of 5° per second. Each beep indicates a 1° heading/course change.

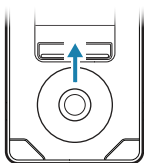

### Heading capture

When in **AUTO** or **NoDrift** mode, the heading capture feature allows you to automatically cancel the turn you are in by an instant upward press on the stick. The autopilot will cancel the turn to continue on the heading read from the compass the very moment you pressed the stick.

### Nav mode

If you request command and the system is in **NAV** mode, you will get immediate command from QS80.

If you initiate **NAV** from any other mode, the required heading change must be confirmed before **NAV** mode is accepted.

If not accepted, the system will remain in current mode.

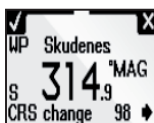

### Wind mode

→ **Note:** Prior to entering **Wind** mode the autopilot system should be operating in **AUTO**, with valid input from the wind transducer.



### Changing set relative wind angle

Use the stick to change the set relative wind angle. The value will change 1° each time the stick is pressed to left or right. If you keep the stick pressed, the value automatically changes at a rate of 5° per second. Each beep indicates a 1° heading/course change.

## Changing commanded rudder direction

By default, the rudder moves in the same direction as the lever on FU80 and NF80. When you press the lever to port, the rudder is directed to port.

If the lever is rotated 180° on an FU80, or if an FU80 or NF80 is mounted facing aft, the rudder movement can be inverted to maintain a rudder command that coincide with the lever movement.

The direction of the port/starboard commands can be changed from the Main menu. Refer “Changing default settings” on page 22.

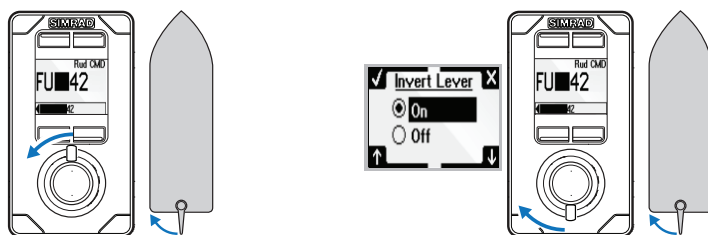

## Alarms



All units, both active and inactive, will notify the user if an alarm situation occurs in the autopilot system.

If the sound is enabled, any alarm message will be followed by a sound.

The **CMD** and **LIGHT** keys are used to acknowledge or mute the alarm sound.

→ **Note:** The alarm can only be acknowledged from an active unit. If the cause for the alarm situation is removed, the alarm dialog will disappear when you press the **CMD** key.



If the cause for alarm remains after acknowledged, the alarm dialog will be replaced by an alarm icon.

If the alarm is steering critical (e.g. rudder feedback failure), the lever or stick will not operate as usual when in an alarm situation.

For alarm text, probable faults and corrective actions, refer to your autopilot Operator manual.

## Restoring factory settings

You can restore all settings back to factory default from the main menu. Refer “Changing default settings” on page 22.

This is a local reset that will only affect the unit where you select the reset option.



## Maintenance

Under normal use, the remotes will require little maintenance.

If the unit requires any form of cleaning, use fresh water and a mild soap solution (not a detergent). It is important to avoid using chemical cleaners and hydrocarbons such as diesel, petrol, etc.

# 4

## Changing default settings

### The main menu

The default settings can be changed from the Main menu, activated by pressing and holding the **MODE** key for 3 seconds.

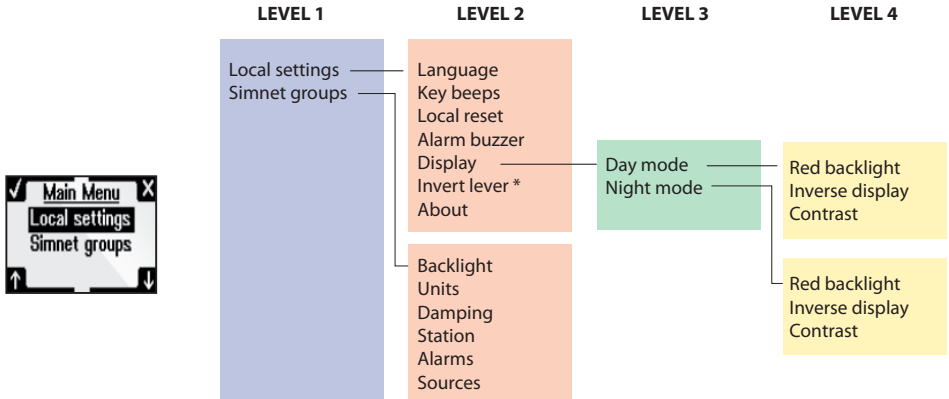

\* Only available on FU80 and NF80.

- Local settings: Gives access to settings that applies to this unit
- SimNet group: Assigns this unit to a SimNet group

You remove the menu and return to standard display by pressing and holding the **STBY** key, or by moving the lever/stick.

➔ **Note:** The main menu is only accessible from **Standby** mode.

# 5

## Specifications

### Technical specifications

→ **Note:** For updated technical specifications, compliance and certifications, refer to our websites.

Display	
Display resolution	128 x 64 (H x W)
Display type	2" Monochrome, Bounded, Transflective
Viewing direction	NF80: 12 o'clock FU80/QS80: 6 o'clock
Power	
Power supply	Via CAN bus or SimNet
Current consumption	Off: Network <20 mA (NMEA 2000: LEN 1) On with max illumination: Network <110 mA (NMEA 2000: LEN 3)
Interface	
CAN/NMEA 2000	Factory connected drop cable with Micro-C connector. 6 m (19.7 ft)
SimNet	Via optional SimNet to Micro-C cable
Technical	
Housing	Front: Aluminum with black plastic snap-on bezel Back: Plastic cover
Temperature	-25° C to + 55° C (-13° F to +131° F)
Weight	NF80, FU80: 0.5 kg (1.10 lbs) QS80: 0.4 kg (0.88 lbs)
Environmental	
Weather	IEC 60945 sec. 8.8, exposed, front when desk mounted or bulkhead mounted with optional frame. Corresponds to IP X6
Compass safe distance	0.4 m (ref. IEC 60945 sec.11.2)

# Drawings

## Dimension, Remotes

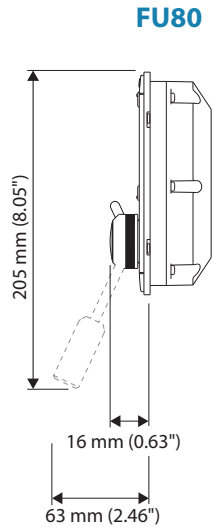
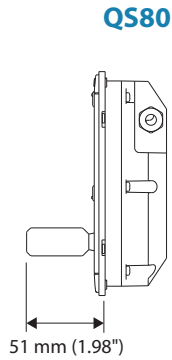
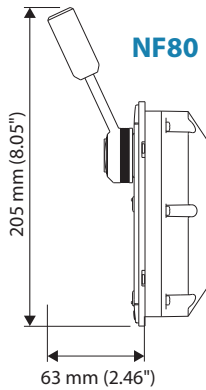
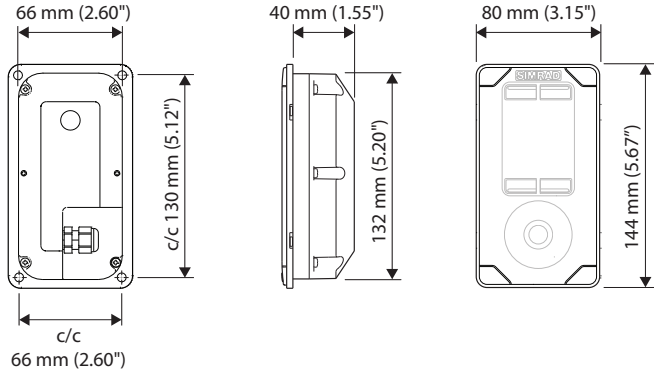

## Dimension, Bulkhead mounting frame

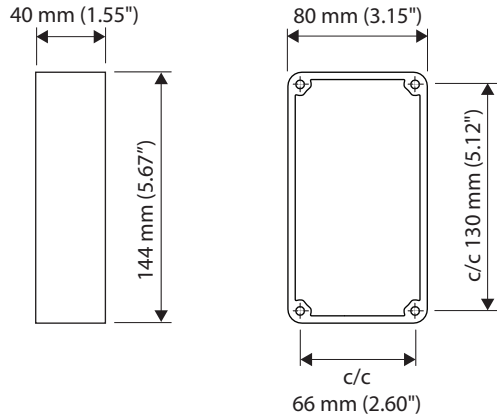

## Connector pin-out

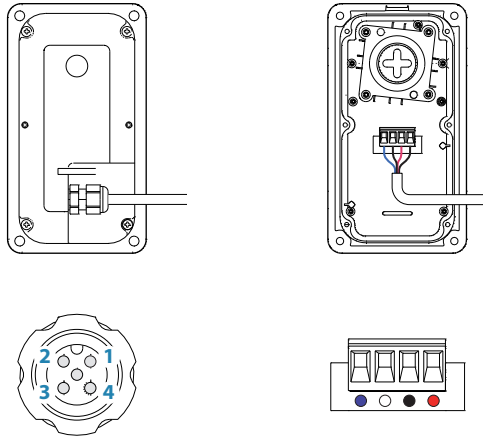

Pin	Color	Function
1		Shield
2	Red	NET-S (Power source +)
3	Black	NET-C (Power source -)
4	White	NET-H (CAN high)
5	Blue	NET-L (CAN low)





**SIMRAD**

