

NORMA 4000/5000

Power Analyzer

Operators Manual

LIMITED WARRANTY AND LIMITATION OF LIABILITY

Each Fluke product is warranted to be free from defects in material and workmanship under normal use and service. The warranty period is two years and begins on the date of shipment. Parts, product repairs, and services are warranted for 90 days. This warranty extends only to the original buyer or end-user customer of a Fluke authorized reseller, and does not apply to fuses, disposable batteries, or to any product which, in Fluke's opinion, has been misused, altered, neglected, contaminated, or damaged by accident or abnormal conditions of operation or handling. Fluke warrants that software will operate substantially in accordance with its functional specifications for 90 days and that it has been properly recorded on non-defective media. Fluke does not warrant that software will be error free or operate without interruption.

Fluke authorized resellers shall extend this warranty on new and unused products to end-user customers only but have no authority to extend a greater or different warranty on behalf of Fluke. Warranty support is available only if product is purchased through a Fluke authorized sales outlet or Buyer has paid the applicable international price. Fluke reserves the right to invoice Buyer for importation costs of repair/replacement parts when product purchased in one country is submitted for repair in another country.

Fluke's warranty obligation is limited, at Fluke's option, to refund of the purchase price, free of charge repair, or replacement of a defective product which is returned to a Fluke authorized service center within the warranty period.

To obtain warranty service, contact your nearest Fluke authorized service center to obtain return authorization information, then send the product to that service center, with a description of the difficulty, postage and insurance prepaid (FOB Destination). Fluke assumes no risk for damage in transit. Following warranty repair, the product will be returned to Buyer, transportation prepaid (FOB Destination). If Fluke determines that failure was caused by neglect, misuse, contamination, alteration, accident, or abnormal condition of operation or handling, including overvoltage failures caused by use outside the product's specified rating, or normal wear and tear of mechanical components, Fluke will provide an estimate of repair costs and obtain authorization before commencing the work. Following repair, the product will be returned to the Buyer transportation prepaid and the Buyer will be billed for the repair and return transportation charges (FOB Shipping Point).

THIS WARRANTY IS BUYER'S SOLE AND EXCLUSIVE REMEDY AND IS IN LIEU OF ALL OTHER WARRANTIES, EXPRESS OR IMPLIED, INCLUDING BUT NOT LIMITED TO ANY IMPLIED WARRANTY OF MERCHANTABILITY OR FITNESS FOR A PARTICULAR PURPOSE. FLUKE SHALL NOT BE LIABLE FOR ANY SPECIAL, INDIRECT, INCIDENTAL OR CONSEQUENTIAL DAMAGES OR LOSSES, INCLUDING LOSS OF DATA, ARISING FROM ANY CAUSE OR THEORY.

Since some countries or states do not allow limitation of the term of an implied warranty, or exclusion or limitation of incidental or consequential damages, the limitations and exclusions of this warranty may not apply to every buyer. If any provision of this Warranty is held invalid or unenforceable by a court or other decision-maker of competent jurisdiction, such holding will not affect the validity or enforceability of any other provision.

BEGRENZTE GEWÄHRLEISTUNG UND HAFTUNGSBESCHRÄNKUNG

Fluke gewährleistet, daß jedes Fluke-Produkt unter normalem Gebrauch und Service frei von Material- und Fertigungsdefekten ist. Die Garantiedauer beträgt 2 Jahre ab Versanddatum. Die Garantiedauer für Teile, Produktreparaturen und Service beträgt 90 Tage. Diese Garantie wird ausschließlich dem Ersterwerber bzw. dem Endverbraucher geleistet, der das betreffende Produkt von einer von Fluke autorisierten Verkaufsstelle erworben hat, und erstreckt sich nicht auf Sicherungen, Einwegbatterien oder andere Produkte, die nach dem Ermessen von Fluke unsachgemäß verwendet, verändert, verschmutzt, vernachlässigt, durch Unfälle beschädigt oder abnormalen Betriebsbedingungen oder einer unsachgemäßen Handhabung ausgesetzt wurden. Fluke garantiert für einen Zeitraum von 90 Tagen, daß die Software im wesentlichen in Übereinstimmung mit den einschlägigen Funktionsbeschreibungen funktioniert und daß diese Software auf fehlerfreien Datenträgern gespeichert wurde. Fluke übernimmt jedoch keine Garantie dafür, daß die Software fehlerfrei ist und störungsfrei arbeitet.

Von Fluke autorisierte Verkaufsstellen werden diese Garantie ausschließlich für neue und nicht benutzte, an Endverbraucher verkaufte Produkte leisten. Die Verkaufsstellen sind jedoch nicht dazu berechtigt, diese Garantie im Namen von Fluke zu verlängern, auszudehnen oder in irgendeiner anderen Weise abzuändern. Der Erwerber hat nur dann das Recht, aus der Garantie abgeleitete Unterstützungsleistungen in Anspruch zu nehmen, wenn er das Produkt bei einer von Fluke autorisierten Vertriebsstelle gekauft oder den jeweils geltenden internationalen Preis gezahlt hat. Fluke behält sich das Recht vor, dem Erwerber Einfuhrgebühren für Ersatzteile in Rechnung zu stellen, wenn dieser das Produkt in einem anderen Land zur Reparatur anbietet, als dem Land, in dem er das Produkt ursprünglich erworben hat.

Flukes Garantieverpflichtung beschränkt sich darauf, daß Fluke nach eigenem Ermessen den Kaufpreis ersetzt oder aber das defekte Produkt unentgeltlich repariert oder austauscht, wenn dieses Produkt innerhalb der Garantiefrist einem von Fluke autorisierten Servicezentrum zur Reparatur übergeben wird.

Um die Garantieleistung in Anspruch zu nehmen, wenden Sie sich bitte an das nächstgelegene und von Fluke autorisierte Servicezentrum, um Rücknahmeinformationen zu erhalten, und senden Sie dann das Produkt mit einer Beschreibung des Problems und unter Vorauszahlung von Fracht- und Versicherungskosten (FOB Bestimmungsort) an das nächstgelegene und von Fluke autorisierte Servicezentrum. Fluke übernimmt keine Haftung für Transportschäden. Im Anschluß an die Reparatur wird das Produkt unter Vorauszahlung von Frachtkosten (FOB Bestimmungsort) an den Erwerber zurückgeschickt. Wenn Fluke jedoch feststellt, daß der Defekt auf Vernachlässigung, unsachgemäße Handhabung, Verschmutzung, Veränderungen am Gerät, einen Unfall oder auf anormale Betriebsbedingungen, einschließlich durch außerhalb der für das Produkt spezifizierten Belastbarkeit verursachten Überspannungsfehlern, zurückzuführen ist, wird Fluke dem Erwerber einen Voranschlag der Reparaturkosten zukommen lassen und erst die Zustimmung des Erwerbers einholen, bevor die Arbeiten begonnen werden. Nach der Reparatur wird das Produkt unter Vorauszahlung der Frachtkosten an den Erwerber zurückgeschickt, und es werden dem Erwerber die Reparaturkosten und die Versandkosten (FOB Versandort) in Rechnung gestellt.

DIE VORSTEHENDEN GARANTIEBESTIMMUNGEN STELLEN DEN EINZIGEN UND ALLEINIGEN RECHTSANSPRUCH AUF SCHADENERSATZ DES ERWERBERS DAR UND GELTEN AUSSCHLIESSLICH UND AN STELLE VON ALLEN ANDEREN VERTRAGLICHEN ODER GESETZLICHEN GEWÄHRLEISTUNGSPFLICHTEN, EINSCHLIESSLICH - JEDOCH NICHT DARAUF BESCHRÄNKT - DER GESETZLICHEN GEWÄHRLEISTUNG DER MARKTFÄHIGKEIT, DER GEBRAUCHSEIGNUNG UND DER ZWECKDIENLICHKEIT FÜR EINEN BESTIMMTEN EINSATZ. FLUKE HAFTET NICHT FÜR SPEZIELLE, UNMITTELBARE, MITTELBARE, BEGLEIT- ODER FOLGESCHÄDEN ODER VERLUSTE, EINSCHLIESSLICH VERLUST VON DATEN, UNABHÄNGIG VON DER URSACHE ODER THEORIE.

Angesichts der Tatsache, daß in einigen Ländern die Begrenzung einer gesetzlichen Gewährleistung sowie der Ausschluß oder die Begrenzung von Begleit- oder Folgeschäden nicht zulässig ist, kann es sein, daß die obengenannten Einschränkungen und Ausschlüsse nicht für jeden Erwerber gelten. Sollte eine Klausel dieser Garantiebestimmungen von einem zuständigen Gericht oder einer anderen Entscheidungsinstanz für unwirksam oder nicht durchsetzbar befunden werden, so bleiben die Wirksamkeit oder Durchsetzbarkeit irgendeiner anderen Klausel dieser Garantiebestimmungen von einem solchen Spruch unberührt.

LIMITES DE GARANTIE ET DE RESPONSABILITE

La société Fluke garantit l'absence de vices de matériaux et de fabrication de ses produits dans des conditions normales d'utilisation et d'entretien. La période de garantie est de deux ans et prend effet à la date d'expédition. Les pièces, les réparations de produit et les services sont garantis pour une période de 90 jours. Cette garantie ne s'applique qu'à l'acheteur d'origine ou à l'utilisateur final s'il est client d'un distributeur agréé par Fluke, et ne couvre pas les fusibles, les batteries/piles interchangeables ni aucun produit qui, de l'avis de Fluke, a été malmené, modifié, négligé, contaminé ou endommagé par accident ou soumis à des conditions anormales d'utilisation et de manipulation. Fluke garantit que le logiciel fonctionnera en grande partie conformément à ses spécifications fonctionnelles pour une période de 90 jours et qu'il a été correctement enregistré sur des supports non défectueux. Fluke ne garantit pas que le logiciel est exempt d'erreurs ou qu'il fonctionnera sans interruption.

Les distributeurs agréés par Fluke appliqueront cette garantie à des produits vendus neufs et qui n'ont pas servi, mais ils ne sont pas autorisés à offrir une garantie plus étendue ou différente au nom de Fluke. Le support de garantie est offert uniquement si le produit a été acheté à un point de vente agréé par Fluke ou bien si l'acheteur a payé le prix international applicable. Fluke se réserve le droit de facturer à l'acheteur les frais d'importation des pièces de réparation ou de remplacement si le produit acheté dans un pays a été expédié dans un autre pays pour y être réparé.

L'obligation de garantie de Fluke est limitée, au choix de Fluke, au remboursement du prix d'achat, ou à la réparation/remplacement gratuit d'un produit défectueux retourné dans le délai de garantie à un centre de service agréé par Fluke.

Pour avoir recours au service de la garantie, mettez-vous en rapport avec le centre de service agréé Fluke le plus proche pour recevoir les références d'autorisation de renvoi, puis envoyez le produit, accompagné d'une description du problème, port et assurance payés (franco lieu de destination), à ce centre de service. Fluke décline toute responsabilité en cas de dégradations survenues au cours du transport. Après une réparation sous garantie, le produit sera retourné à l'acheteur, en port payé (franco lieu de destination). Si Fluke estime que le problème a été causé par une négligence, un mauvais traitement, une contamination, une modification, un accident ou des conditions de fonctionnement ou de manipulation anormales, notamment de surtensions liées à une utilisation du produit en dehors des spécifications nominales, ou de l'usure normale des composants mécaniques, Fluke fournira un devis des frais de réparation et ne commencera la réparation qu'après en avoir reçu l'autorisation. Après la réparation, le produit sera renvoyé à l'acheteur, en port payé (franco point d'expédition) et les frais de réparation et de transport lui seront facturés.

LA PRÉSENTE GARANTIE EST EXCLUSIVE ET TIENT LIEU DE TOUTES AUTRES GARANTIES, EXPRESSES OU IMPLICITES, Y COMPRIS, MAIS NON EXCLUSIVEMENT, TOUTE GARANTIE IMPLICITE DE VALEUR MARCHANDE OU D'ADÉQUATION À UN USAGE PARTICULIER. FLUKE NE POURRA ETRE TENU RESPONSABLE D'AUCUN DOMMAGE PARTICULIER, INDIRECT, ACCIDENTEL OU CONSECUTIF, NI D'AUCUN DEGAT OU PERTE, DE DONNEES NOTAMMENT, SUR UNE BASE CONTRACTUELLE, EXTRA-CONTRACTUELLE OU AUTRE.

Etant donné que certains pays ou états n'admettent pas les limitations d'une condition de garantie implicite, ou l'exclusion ou la limitation de dégâts accidentels ou consécutifs, il se peut que les limitations et les exclusions de cette garantie ne s'appliquent pas à chaque acheteur. Si une disposition quelconque de cette garantie est jugée non valide ou inapplicable par un tribunal ou un autre pouvoir décisionnel compétent, une telle décision n'affectera en rien la validité ou le caractère exécutoire de toute autre disposition.

有限保证和责任限制

在正常使用和维护条件下，Fluke 公司保证每一个产品都没有材料缺陷和制造工艺问题。保证期为从产品发货之日起二年。部件、产品修理和服务的保证期限为 90 天。本项保证仅向授权零售商的原始买方或最终用户提供，并且不适用于保险丝和一次性电池或者任何被 Fluke 公司认定由于误用、改变、疏忽、意外、非正常操作和使用所造成的产品损坏。Fluke 公司保证软件能够在完全符合性能指标的条件下至少操作 90 天，而且软件是正确地记录在无缺陷的媒体上。Fluke 公司并不保证软件没有错误或无操作中断。

Fluke 公司仅授权零售商为最终客户提供新产品或未使用过产品的保证。但并未授权他们代表 Fluke 公司提供范围更广或内容不同的保证。只有通过 Fluke 授权的销售商购买的产品，或者买方已经按适当的国际价格付款的产品，才能享受 Fluke 的保证支持。在一个国家购买的产品被送往另一个国家维修时，Fluke 公司保留向买方收取修理/更换零部件的进口费用的权利。

Fluke 公司的保证责任是有限的，Fluke 公司可以选择是否将依购买价退款、免费维修或更换在保证期内退回 Fluke 公司委托服务中心的有缺陷产品。

要求保修服务时，请与就近的 Fluke 授权服务中心联系，获得退还授权信息；然后将产品连同问题描述寄至该服务中心，并预付邮资和保险费用（目的地离岸价格）。Fluke 对运送途中发生的损坏不承担责任。在保修之后，产品将被寄回给买方并提前支付运输费（目的地交货）。如果 Fluke 认定产品故障是由于疏忽、滥用、污染、修改、意外或不当操作或处理状况而产生，包含使用超出产品特定的额定值而导致过电压故障，或是由于机件日常使用耗损，则 Fluke 会估计修理费用，在实际修理之前先获得买方同意。在修理之后，产品将被寄回给买方并预付运输费；买方将收到修理和返程运输费用（寄发地交货）的帐单。

本保证为买方唯一能获得的全部赔偿内容，并且取代所有其它明示或隐含的保证，包括但不限于适销性或适用于特殊目的的任何隐含保证。FLUKE 不对由于任何原因或推理所发生的任何特殊、间接、偶发或后续的损坏或损失承担赔偿责任，包括数据丢失。

由于某些国家或州不允许对隐含保证的期限加以限制、或者排除和限制意外或后续损坏，本保证的限制和排除责任条款可能并不对每一个买方都适用。如果本保证的某些条款被法院或其它具有适当管辖权的裁决机构判定为无效或不可执行，则此类判决将不影响任何其它条款的有效性或可执行性。

Table of Contents

Chapter	Title	Page
1	About this Document	1-1
	Signs and Symbols.....	1-3
	Transport and Storage.....	1-3
	Transport	1-3
	Storage.....	1-3
	Recalibration.....	1-3
	Maintenance.....	1-3
	Decommissioning and Disposal.....	1-4
	Shutting Down.....	1-4
	Recycling and Disposal	1-4
	Housing	1-4
	Electronic Components	1-4
2	General Safety Instructions.....	2-1
	Introduction.....	2-3
	Protection Class	2-3
	Qualified Personnel.....	2-3
	Safe Operation	2-3
	Proper Use.....	2-3
	Warranty	2-3
	Electrical Connections	2-4
	Binding Post.....	2-4
	Risks During Operation	2-5
	Maintenance and Repairs.....	2-5
	Accessories	2-5
	Shutting Down	2-5
	Safety Instructions on the Device Housing.....	2-5
	Mains Connection.....	2-5
	Input Voltage and Current.....	2-5
	Maintenance	2-6
	Indoor Use	2-6
3	Design and Functions	3-1
	About this Chapter	3-3

	Terminals (Back)	3-3
	Operating Controls and Display.....	3-4
	Navigation and Measuring Keys	3-5
	Navigation through Display	3-6
	Overview of Function Keys.....	3-6
	Functions.....	3-7
4	Startup	4-1
	Taking Inventory.....	4-3
	Installation and Switching On.....	4-3
	Installation	4-3
	Switching Device On.....	4-3
	Switching Device Off.....	4-4
5	Connection to Circuits	5-1
	Before You Begin	5-3
	Connecting Sequence.....	5-3
	Overview.....	5-4
	1-Phase Measurement.....	5-4
	Direct Connection.....	5-4
	Measurement with Shunt.....	5-6
	Measurement with Voltage and Current Transducer.....	5-7
	Aron Circuit (2-Wattmeter Method, W2).....	5-8
	Direct Connection.....	5-8
	Measurement with Shunt.....	5-10
	Measurement with Voltage and Current Transducer.....	5-11
	3-Phase Measurement (W3).....	5-13
	Direct Connection.....	5-13
	Measurement with Shunt.....	5-14
	Measurement with Voltage and Current Transducer.....	5-15
	Measurement with Star Point Adapter.....	5-17
6	Simple Measurement	6-1
	About this Chapter	6-3
	Connection to Circuits	6-3
	Configuration.....	6-3
	Measuring	6-4
7	Configuration	7-1
	Set Up for Measuring.....	7-3
	Configuration.....	7-3
	Five Steps.....	7-4
	Call up General Setup and System Information Screen.....	7-4
	General Setup	7-4
	System Information Screen	7-4
	Load Configuration.....	7-5
	Load Configuration (Optional).....	7-5
	Modify Loaded Configurations	7-5
	Configure Method.....	7-5
	Configure Data Transfer to Printer and PC.....	7-5
	Configure External Printer	7-6
	Configure Interface to PC.....	7-7
	Configure RS 232	7-7

Configure GPIB Address.....	7-8
Configure Ethernet	7-8
Configure Average Time and Synchronization	7-9
Timing & Sync Setup	7-9
Set Average Time	7-10
Select Synchronization Source	7-11
Set Trigger Level.....	7-11
Select Slope Direction	7-12
Select Low-Pass Filter	7-12
Configure Signal Output.....	7-12
Adjust Date and Time	7-13
Configure Current and Voltage Channels	7-13
Current Channel Setup	7-14
Configure Input Range	7-15
Automatic Range Adjustment (Auto)	7-15
Manual Range Adjustment (Range).....	7-15
Configure Scale	7-15
Configure Coupling.....	7-16
Configure Filter	7-17
Voltage Channel Setup	7-17
Switch Current Input to External Input (BNC).....	7-18
Switch Current Input	7-18
Configure Auto-Range Selection.....	7-18
Configure Scale	7-18
Integration Function Configuration	7-19
Integration Setup	7-19
Select Integration Value	7-21
Configure Status	7-21
Configure Start	7-22
Configure Stop.....	7-23
Save Configuration	7-23
Delete Configuration.....	7-24
Undersampling and Aliasing.....	7-24
8 Measuring Process	8-1
Introduction.....	8-3
Prior to Measuring	8-3
Measuring with Default Configuration.....	8-3
Measuring with User-Defined Configuration.....	8-3
Measure Voltage, Current and Power.....	8-4
Measured Values for Individual Channels	8-4
View the Values of One Channel.....	8-4
View Detailed Values of One Channel	8-4
View Totals of all Measured Values	8-7
View Totals	8-7
View Efficiency	8-8
Compare Measured Values.....	8-9
View Fundamental Values	8-11
View Fundamental Value Details.....	8-11
User-Defined Screen View.....	8-13
View User-Defined Screen	8-13
Select Numeric Values.....	8-14
Change User-Defined Display Size.....	8-15
Save User Defined Screen.....	8-15

Back to Common Numeric Screen.....	8-15
Change View Mode	8-15
Numerical Display.....	8-16
Vector Graphs.....	8-16
View Vector Graphs.....	8-16
Adjust Scale	8-16
Oscilloscope Curves	8-17
View Oscilloscope Display	8-17
Adjust Scale of Axes.....	8-18
Adjust Zero	8-18
Recorder View.....	8-18
Harmonic Analysis	8-19
FFT Mode.....	8-21
Adjust Scale	8-21
View Details of a Measured Value	8-22
Set Frequency Range.....	8-22
Set View Mode.....	8-24
Harmonic Order Mode	8-24
View Harmonics.....	8-24
View Harmonics Spectrum Relative to Fundamental in %.....	8-26
STD Harmonic Mode (EN 61000-4-7 Ed 2.1 compliant)	8-28
View Harmonics.....	8-28
Integration Function/Electrical Work	8-31
Save and Print Measurements.....	8-33
Save Measurements	8-33
Print Measurements	8-33
VNC Remote Operation.....	8-33
Introduction	8-33
VNC Device Support.....	8-33
9 NORMA Process Interface (Optional).....	9-1
Process Interface	9-3
Pin Assignment	9-3
Measured Values.....	9-4
Torque	9-4
Rotational Speed.....	9-4
Sense of Direction	9-4
Configuring the Process Interface.....	9-4
Call Up Motor/Generator Setup	9-4
Select Motor	9-5
Configure Torque Sensor	9-6
Configure Speed Sensor	9-6
Configure Motor or Generator.....	9-6
Configure Other Motors	9-7
Configure Analog Output.....	9-7
Measuring with the Process Interface	9-8
View Measured Electric Values	9-8
View Mechanical Values.....	9-9
View Raw Values	9-10
View Torque – All Motors	9-10
View Speed – All Motors.....	9-11
Process Interface - Technical Data	9-12
Eight Inputs (Analog/Digital).....	9-12
Input Configured as Analog Input.....	9-12

	Input Configured as Digital Input	9-12
	Four Digital Inputs for the Detection of the Sense of Rotation	9-12
	Four Outputs (Analog)	9-12
10	Measured Values Computation	10-1
	Measured values per phase x (channel x – values are indexed x).....	10-3
	Total values (sum or average).....	10-4
	Frequency Analysis.....	10-6
	Optional Process Interface Formulas	10-7
11	Technical Data	11-1
	Technical Data Fluke NORMA 4000/5000	11-3
	General Technical Data	11-3
	Reference Conditions	11-3
	Ambient Conditions.....	11-3
	Standards	11-3
	Interfaces	11-4
	Data Memory.....	11-4
	Configuration Memory	11-4
	Channel Specifications	11-4
	Voltage.....	11-4
	Current	11-4
	Frequency and Synchronization	11-5
	Intrinsic Uncertainty (Reference Conditions) Voltage and Current	11-5
	Intrinsic Uncertainty (Reference Conditions) Active Power.....	11-5
	Block Diagrams	11-9
	Overview	11-9
	Voltage Channels.....	11-10
	Current Channels.....	11-10
12	Service and Accessories	12-1
	Instrument	12-3
	Analyzer	12-3
	Optional Equipment.....	12-3
	Standard Equipment	12-3
	Accessories	12-11
	Accessories.....	12-11
	Software.....	12-11
	Service	12-12
	General	12-12

List of Tables

Table	Title	Page
1-1.	Symbols.....	1-3
3-1.	Terminal Descriptions.....	3-3
3-2.	Display Descriptions.....	3-4
3-3.	Status Symbols.....	3-5
3-4.	Navigation Control Descriptions.....	3-5
3-5.	Function Keys.....	3-6
7-1.	Configuration Menus.....	7-3

List of Figures

Figure	Title	Page
2-1.	Binding Post Connection.....	2-4
3-1.	Terminals.....	3-3
3-2.	Display	3-4
3-3.	Navigation	3-5
5-1.	Phase Measurement-Current Input and Mains	5-5
5-2.	Phase Measurement-Current Input and Load.....	5-5
5-3.	Measurement with Shunt.....	5-6
5-4.	Voltage and Current Transducer Measurement.....	5-7
5-5.	Aron Circuit-Direct Measurement	5-9
5-6.	Aron Circuit-Shunt Measurement	5-10
5-7.	Aron Circuit-Voltage and Current Transducer Measurement	5-12
5-8.	3-Phase Measurement-Direct Connection.....	5-13
5-9.	3-Phase Measurement with Shunt	5-14
5-10.	3-Phase (W3) Voltage and Current Transducer Measurement.....	5-16
5-11.	3-Phase Measurement with Star Point Adapter.....	5-17
9-1.	Process Interface Pin Assignment	9-3
11-1.	Active Power (PP64 – AAF on 45 to 65 Hz)	11-7
11-2.	Active Power (AAF off - 45 to 65 Hz - V=100%).....	11-7
11-3.	Active Power (AAF on - Magnitude V & I 100%)	11-7
11-4.	Linearity of U & I in % vs. rdg/rng in % (50/60 Hz).....	11-8
11-5.	Uncertainty in % of U & I vs. Frequency (rdg/rng = 100%, antialiasing filter off)	11-8

Chapter 1







About this Document

Title	Page
Signs and Symbols.....	1-3
Transport and Storage.....	1-3
Transport	1-3
Storage.....	1-3
Recalibration.....	1-3
Maintenance.....	1-3
Decommissioning and Disposal.....	1-4
Shutting Down.....	1-4
Recycling and Disposal	1-4
Housing	1-4
Electronic Components	1-4

Signs and Symbols

Table 1-1 is a list of symbols used in this document.

Table 1-1. Symbols

Symbol	Description
	Risk of danger. Important information.
	Hazardous voltage. Risk of electrical shock.
	<i>Conformité Européenne.</i> Conforms to requirements of European Union and European Free Trade Association (EFTA).
	Conforms to relevant North American Safety Standards.
	Conforms to relevant Australian Standards.
	Do not dispose of this product as unsorted municipal waste. Go to Fluke's website for recycling information.
	Earth ground.

Transport and Storage

Transport

- Transport the device in its original packaging.
- Protect the device during transport against heat and moisture; do not exceed temperature range of $-20\text{ }^{\circ}\text{C}$ to $+50\text{ }^{\circ}\text{C}$ ($-4\text{ }^{\circ}\text{F}$ to $+122\text{ }^{\circ}\text{F}$) and maximum humidity of 85 %.
- Protect the device against impacts and loads.

Storage

- Keep original packaging, as it might be required at a later stage for transport purposes or to return the device for repairs. Only the original packaging guarantees proper protection against mechanical impacts.
- Store the device in a dry room; the temperature range of $-20\text{ }^{\circ}\text{C}$ to $+50\text{ }^{\circ}\text{C}$ ($-4\text{ }^{\circ}\text{F}$ to $+122\text{ }^{\circ}\text{F}$) and maximum humidity of 85 % may not be exceeded.
- Protect the device against direct sunlight, heat, moisture, and mechanical impacts.

Recalibration

The manufacturer recommends recalibrating the device every 2 years. For information about how to obtain service and calibration, check the Fluke website: www.fluke.com.

Maintenance

Ensure that the ventilation slots are not blocked. Otherwise, the device is maintenance free.

Decommissioning and Disposal

Shutting Down

- Ensure that all connected devices are switched off and disconnected from the power supply.
- Switch off the Power Analyzer.
- Disconnect the plug from the mains (power) socket.
- Remove all connected devices.
- Secure the unit against inadvertent switching on.
- Keep the Operators Manual near the device.

Recycling and Disposal

Always adhere to the applicable statutory regulations for recycling and waste disposal.

Housing

The housing is made of metal and can be recycled.

Electronic Components

The electronic components including the power adapter, filter, plug-in modules, and wires have a weight of approximately 1500 g (3.3 lb) and a volume of approximately 3000 cm³ (183 in³).

Chapter 2

General Safety Instructions

Title	Page
Introduction.....	2-3
Protection Class	2-3
Qualified Personnel.....	2-3
Safe Operation	2-3
Proper Use.....	2-3
Warranty	2-3
Electrical Connections	2-4
Binding Post.....	2-4
Risks During Operation	2-5
Maintenance and Repairs	2-5
Accessories	2-5
Shutting Down	2-5
Safety Instructions on the Device Housing.....	2-5
Mains Connection.....	2-5
Input Voltage and Current	2-5
Maintenance	2-6
Indoor Use	2-6

Introduction

The design and manufacture of this device conform to the latest state of technology and the safety standards defined in IEC 61010-1/ 2nd edition. If used improperly, there is a risk of damage to persons and property.

Protection Class

The device is assigned to protection class I according to IEC 61010-1 and is equipped with a protective earth connector.

Qualified Personnel

The device may be operated only by qualified personnel.

This means only persons who are familiar with the installation, assembly, connection, inspection of connections, and operation of the analyzer and who have completed training in at least one of the following areas:

- Switching on/off, enabling, earth-grounding and identification of electrical circuits and devices/systems according to the applicable safety standards.
- Maintenance and operation of appropriate safety gear, in accordance with the applicable safety standards.
- First aid.

Safe Operation

- Ensure that all persons using the device have read and fully understood the Operators Manual and safety instructions.
- The device may only be used under certain ambient conditions. Ensure that the actual ambient conditions conform to the admissible conditions laid down in the chapter "Technical Data".
- During operation, ensure that the cooling vents are not obstructed.
- Always comply with the instructions in Chapter 1, "Transport and Storage".

Proper Use

Do not use the device for any other purpose than the measuring of voltages and currents that are within the measuring ranges and categories, including voltage to earth ground, detailed in the "Technical Data" chapter.

Improper use shall void all warranty.

Warranty

- The warranty period for fault-free operation is limited to 2 years from the date of purchase.
- The warranty period for accuracy is 2 years.

Electrical Connections

- Ensure that the power and connecting cables used with the device are in proper working order.
- Ensure that the protective earth ground connector of the power lead is connected according to the instructions of the low-resistance unit earth ground cable.
- Ensure that the power and connecting cables as well as all accessories used in conjunction with the device are in proper working order and clean.
- Install the device in such a way that its power cable is accessible at all times and can easily be disconnected.
- For connection work, work in teams of at least two persons.
- Do not use the device if the housing or an operating element is damaged.

Binding Post

To maintain proper clearance distances, the lug must be correctly connected to the connection terminal (binding post).

Warning

To avoid possible electric shock or personal injury from flashover caused by CAT III transients between the housing and the lug, see Figure 2-1:

- The minimum clearance distance must comply with at least the distance illustrated in ①.
- Do not reverse ② or bend the lug ③ towards the housing.
- Use only insulated lugs preferably assembled with shrinking tube as illustrated in ④.
- If the connection leads exceed a cross section of 0.75 mm², an additional external-protective conductor with the same cross section must be installed between the protective earth terminal ⑤ and the protective earth of the measuring circuit.

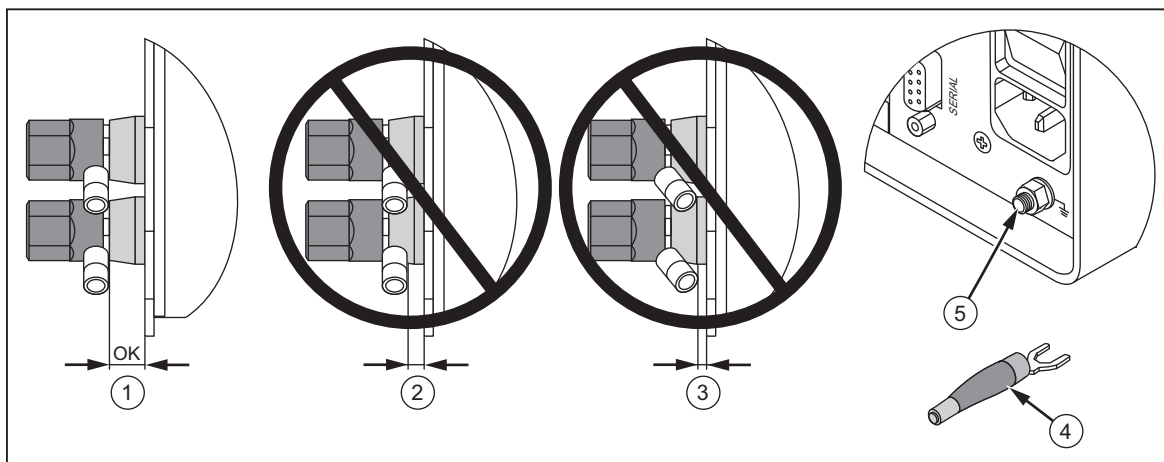

Figure 2-1. Binding Post Connection

Risks During Operation

- Ensure that the connected devices work properly.
- In the case of a direct connection to current circuits (without transformer or shunt), ensure that the circuit is protected to maximum 16 A.
- Shunts and conductors generate heat when in use and surfaces may burn the skin.

Maintenance and Repairs

- Do not open the housing. Do not carry out any repairs and do not replace any component parts of the device.
- Damaged connecting and power leads must be repaired or replaced by an authorized service technician.
- Damaged or defective devices may only be repaired by authorized technicians.

Accessories

- Only use the accessories supplied with the device or specifically available as optional equipment for your model.
- Ensure that any third-party accessories used in conjunction with the device conform to the IEC 61010-031/61010-2-032 standard and are suitable for the respective measuring voltage range.

Shutting Down

- If you detect any damage to the housing, controls, power cable, connecting leads, or connected devices, immediately disconnect the unit from the power supply.
- If you are in doubt as regards the safe operation of the device, immediately shut down the unit and the respective accessories, secure them against inadvertent switching on, and bring them to an authorized service agent.

Safety Instructions on the Device Housing

Mains Connection

MAINS 85 - 264 V \sim / 47 - 440Hz / 120 - 300 V \equiv
Mains connection must conform to these ranges/values
40 VA (NORMA 4000) and 65 VA (NORMA 5000)
Maximum power consumption

Input Voltage and Current

Warning

To avoid possible electric shock or personal injury:

VOLTAGE INPUTS MAX 1000 V CAT II to \perp

CURRENT INPUTS MAX 1000 V CAT II to \perp

If the measuring circuit is used to measure MAINS, the voltage to earth \perp may not exceed 1000 V in a CAT II Overvoltage Category environment.

Maintenance

No internal parts are user serviceable. Always use a qualified service center for service.

Indoor Use

The device may only be used indoors.

Chapter 3

Design and Functions

Title	Page
About this Chapter	3-3
Terminals (Back)	3-3
Operating Controls and Display.....	3-4
Navigation and Measuring Keys	3-5
Navigation through Display	3-6
Overview of Function Keys.....	3-6
Functions.....	3-7

About this Chapter

This chapter provides an overview of the terminals, ports and interfaces of the Fluke NORMA 4000/5000 Power Analyzer (referred to throughout as “the Power Analyzer”). It also includes a list of display and operating devices and a brief introduction to the basic functions of the unit.

Terminals (Back)

Figure 3-1 illustrates the terminals on the back of the Power Analyzer. Table 3-1 is a list of the terminal descriptions.

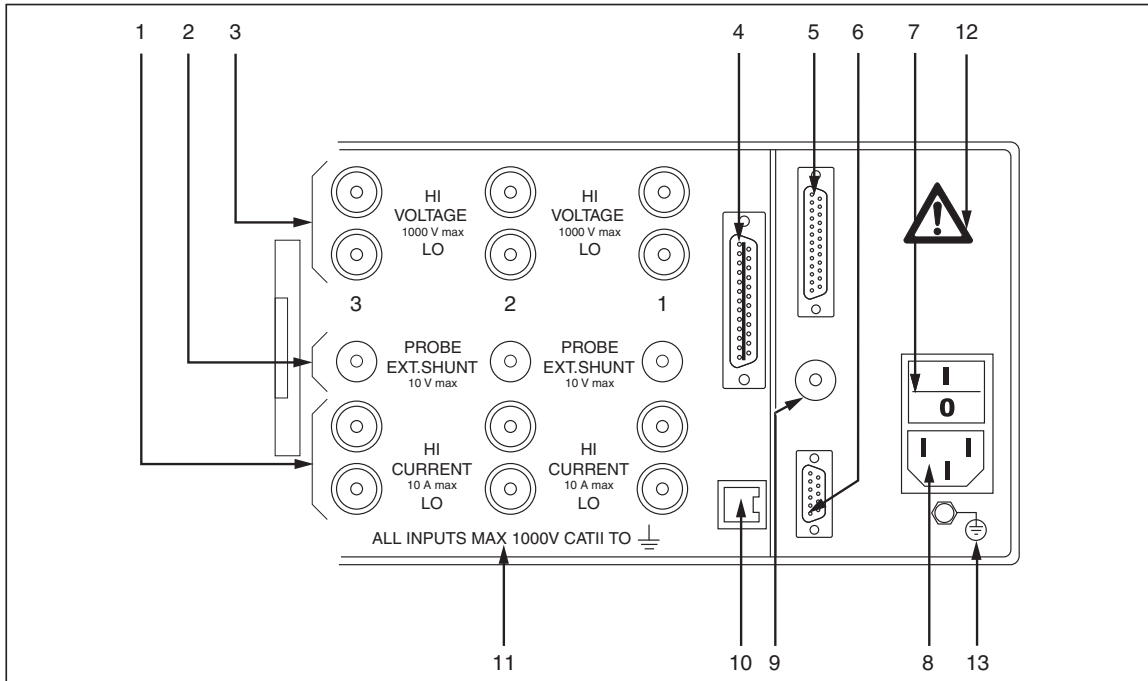

Figure 3-1. Terminals

esn005.eps

Table 3-1. Terminal Descriptions

Item	Description
1	Measuring inputs for current (channels 1 to 6) HI: Conductor, positive LO: Conductor, negative
2	Measuring inputs for shunts (channels 1 to 6)
3	Measuring inputs for voltage (channels 1 to 6) HI: Conductor, positive LO: Conductor, negative
4	IEEE488 interface (optional)
5	Port for Analog Interface
6	Serial interface (RS232)
7	Power switch I (on) and O (off)
8	Mains (power) connection
9	Input for external synchronization signal
10	IF1 network adapter (LAN) (optional)
11	Warning regarding maximum voltage to earth ground
12	Warning symbol: danger, observe operating instructions
13	Earth Ground

Operating Controls and Display

The display, operating controls, and function keys are located at the front of the Power Analyzer. The display consists of a menu bar, a section in which the measured values and the channel settings are shown, and the assignment bar for the function keys. Figure 3-2 illustrates the location of the operating controls on the display and Table 3-2 is a list of control descriptions.

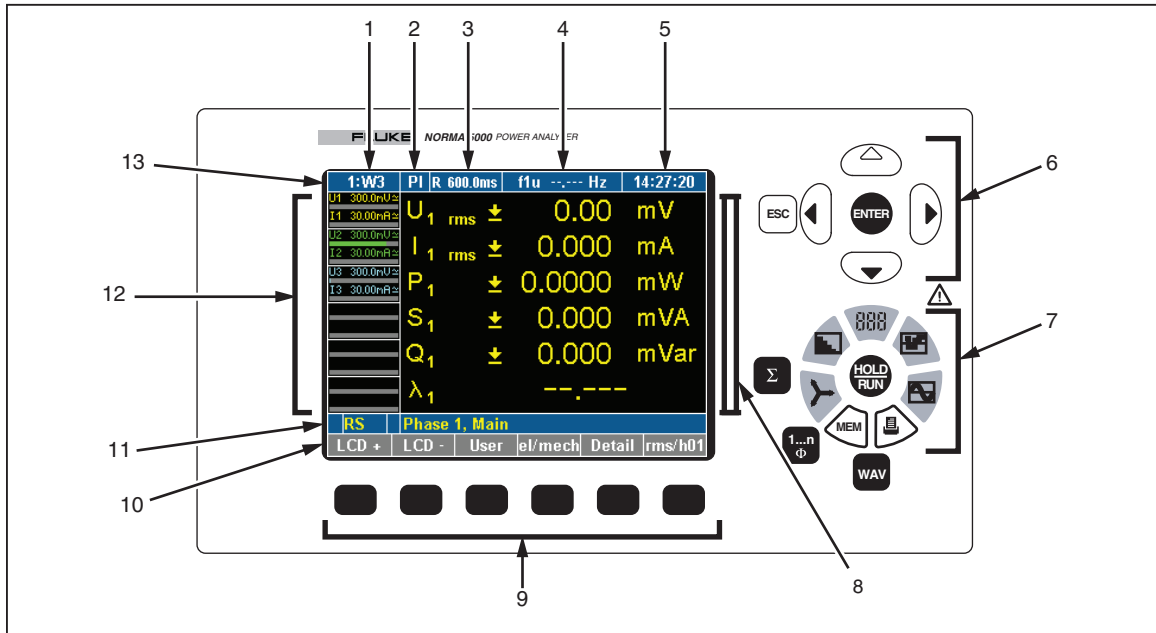

Figure 3-2. Display

esn006.eps

Table 3-2. Display Descriptions

Item	Description
1	Display of configuration; menu item General Setup
2	Menu item Integration Setup/Motor-Generator Setup
3	Measurement status/display of average time
4	Display of synchronization source frequency; menu item Timing & Sync Setup
5	Display of time; menu item Clock Setup
6	Navigation keys
7	Measuring keys
8	Display for measured values
9	Function keys
10	Assignment bar for function keys
11	Information row
12	Status display for channels 1 to 6 (including measuring range, coupling, and modulation bar); menu items Current Channel Setup and Voltage Channel Setup
13	Menu bar with menu items

Table 3-3 is an explanation of the status symbols.

Table 3-3. Status Symbols

Status	Description
M	Memory record active
T	Wait for Trigger start condition (memory)
R	Measurement active (Run mode)
H	Measurement stopped (Hold mode)
∫	Integration of selected values active

Navigation and Measuring Keys

Figure 3-3 illustrates the navigation and measuring keys on the Power Analyzer. Table 3-4 is a list of the descriptions for the navigation and measuring keys.

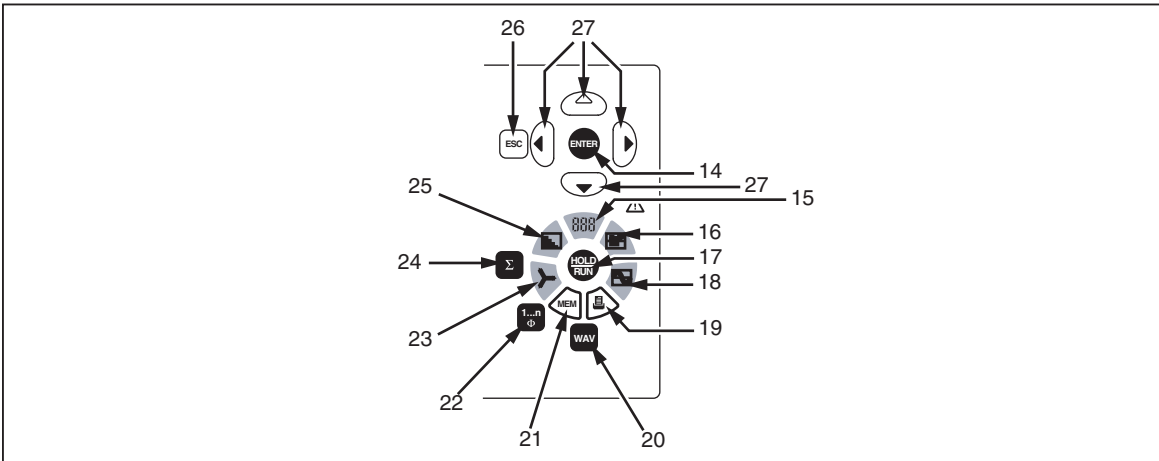

Figure 3-3. Navigation

esn007.eps

Table 3-4. Navigation Control Descriptions

Item	Description
14	Enter: confirm; call up menu
15	Numerical display
16	Recorder
17	Hold/Run: start and stop measurement
18	Oscilloscope diagrams
19	Print
20	Show power, current, voltage
21	Save
22	Select channel
23	Vector display
24	Show totals of all channels
25	Frequency analysis
26	Esc: cancel, up one menu level
27	Cursor keys: up, down, left, and right

Navigation through Display

1. Use the navigation keys (6) and (27) to navigate through the display and the menus.
The active menu item, display, or entry field in which your cursor is located is backlit.
2. Press Esc (26) to cancel an entry without saving or to go to the next higher menu level.
3. Press Enter (14) to call up a menu or to confirm an entry made in a menu.
4. Press the measuring keys (7) and (15) to (25) to select the display mode and the save or output functions for measured values.

The assignment of the function keys (9) varies, depending on the current menu. The current key assignment is shown on the assignment bar (10) located above the function keys.

Overview of Function Keys

Table 3-5 is a list of the function keys. The assignment of the function keys varies depending on the display or menu you have selected.

Table 3-5. Function Keys

Name	Function
Default	Scale axes automatically
DELETE	Delete configuration
Detail	View details of a measured value
Freq	Set frequency analysis filter
Info...	View system information and version number of unit firmware
LCD -	Reduce brightness of display
LCD +	Increase brightness of display
lin/log	View linear/logarithmic scale
LOAD	Load configuration
mode	View table with harmonics
Offset	Adjust zero (with cursor keys)
rms/h01	View rms values or H01 fundamental
SAVE	Save configuration
Scale	Adjust scales of axes (with cursor keys)
scroll	Scroll through display
Set all	Adopt configuration or set value for all channels
tab/gra	View measured values in table/graph
U/I	Switch between voltage channel configuration and current channel configuration (in General Setup)
zoom	Adjust scales of axes (with cursor keys)
∫	View electrical work reference power or recuperated power
∫ Clear	Set electrical work integration to zero
∫ Start	Start electrical work integration
∫ Stop	Stop electrical work integration

Functions

The Power Analyzer allows for the analysis of currents from dc to several MHz. Voltage values up to 1000 V and currents up to 20 A (depending on measurement modules installed in the instrument) are measured accurately, and the respective real, reactive, and apparent power is calculated. The limit of error is between 0.03 % and 0.3 %, depending on the model. See the technical specifications for detailed information. For dc and ac up to a few MHz, it is not affected by the wave shape, frequency, or phase position. The measuring range can be extended by connecting shunts or clamps. When extending the range using third-party shunts or clamp, the extra errors due to these devices should be considered. The device allows for simultaneous measuring in up to six channels.

Chapter 4

Startup

Title	Page
Taking Inventory.....	4-3
Installation and Switching On.....	4-3
Installation.....	4-3
Switching Device On.....	4-3
Switching Device Off.....	4-4

Taking Inventory

Before you work with the analyzer, check the delivery to ensure that it is complete, using the following list and the delivery specifications:

- 1 Power Analyzer
- 1 Operators Manual
- 1 mains (power) cable
- 1 calibration certificate
- 1 built-in printer (if ordered)
- 1 to 6 voltage and current channel modules, according to the delivery specifications

Installation and Switching On

Installation

Warning

To avoid possible electric shock or personal injury:

- **The device is connected to the power mains with a number of internal components live with dangerous voltage levels.**
- **The device must be equipped with a low-resistance connection to earth ground.**
- **Carefully check the mains socket and its wiring.**

To install:

1. Follow the safety instructions regarding ambient conditions and location of installation.
2. Place the device on a clean and stable surface.
3. If necessary, adjust the feet at the base of the unit to improve the view of the display.

Switching Device On

To turn the Analyzer on:

1. Connect the Analyzer to the power (mains) socket, using the power cable.
2. Set the power switch on the back of the housing to **I** (on). The Analyzer is now ready for operation. The following start screen displays.

1:W3		PI	R 600.0ms	f1u --.--- Hz	14:27:20
U1 300.0mV \approx	U ₁	rms	↓	0.00	mV
I1 30.00mA \approx					
U2 300.0mV \approx	I ₁	rms	↓	0.000	mA
I2 30.00mA \approx					
U3 300.0mV \approx	P ₁	↓	0.0000	mW	
I3 30.00mA \approx					
	S ₁	↓	0.000	mVA	
	Q ₁	↓	0.000	mVar	
	λ_1		--.---		
RS	Phase 1, Main				
LCD +	LCD -	User	el/mech	Detail	rms/h01

esn008.gif

Switching Device Off

1. Toggle the power switch in the back of the housing to **O** (off).
2. If the Analyzer is not to be used for a prolonged period of time, disconnect the plug from the mains (power) socket.

Chapter 5

Connection to Circuits

Title	Page
Before You Begin	5-3
Connecting Sequence.....	5-3
Overview.....	5-4
1-Phase Measurement.....	5-4
Direct Connection.....	5-4
Measurement with Shunt.....	5-6
Measurement with Voltage and Current Transducer.....	5-7
Aron Circuit (2-Wattmeter Method, W2).....	5-8
Direct Connection.....	5-8
Measurement with Shunt.....	5-10
Measurement with Voltage and Current Transducer.....	5-11
3-Phase Measurement (W3).....	5-13
Direct Connection.....	5-13
Measurement with Shunt.....	5-14
Measurement with Voltage and Current Transducer.....	5-15
Measurement with Star Point Adapter.....	5-17

Before You Begin

Carefully read and adhere to the following warning statements before you connect the Power Analyzer.

Warning

To avoid possible electric shock or personal injury:

- **By connecting the Power Analyzer to active circuits, the terminals and certain parts inside the Power Analyzer are live.**
- **To ensure safe operation, first connect the Power Analyzer to the power supply.**
- **If possible, open the circuit before establishing a connection to the Power Analyzer.**
- **Before connecting the circuits, ensure that the maximum measuring voltage and maximum voltage to earth ground (1000 V CATII and 600 V CATIII respectively) are not exceeded.**
- **Do not use leads and accessories that do not comply with relevant safety standards, as this could lead to serious injury or death from electric shock.**
- **To avoid damage to the instrument, never apply voltage to the current shunt inputs (lower set of input jacks, blue).**

Connecting Sequence

For safety reasons, when connecting a circuit to the Power Analyzer, proceed in the sequence outlined as follows:

1. Connect the Power Analyzer to the mains (power) socket.
 The Power Analyzer is now connected to the protective earth ground wire.
2. Switch on the Power Analyzer.
3. Connect the measuring circuit as shown in the connection diagrams later in this Operators Manual.
 To ensure that the measured values are indicated correctly, connect the phase to HI so that the energy flow is from HI to LO.
4. Connect the circuit to the power supply.

Overview

The Fluke NORMA 4000/5000 Power Analyzer offers the following options for connection:

- 1-phase measurement
- Aron circuit (W2)
- 3-phase measurement (W3)

Note

When connecting a 4-channel device for electrical efficiency analysis, the 3-phase power cables for this measurement should be connected to the measuring channels 1 to 3, so that the efficiency can be calculated and displayed directly on the Power Analyzer.

1-Phase Measurement

Direct Connection

- Ensure that there is no overload at the current input of the Power Analyzer.
- If necessary, install appropriate fuses.

Warning

To avoid possible electric shock or personal injury:

- **Risk of injury when touching connections, internal circuits and measuring devices that are not connected to earth ground.**
- **Always adhere to the instructions regarding the sequence of connection (see Chapter 5, “Connecting Sequence”).**

The difference between the connection of the voltage input between the current input and the mains (Figure 5-1) or between the current input and the load (Figure 5-2) is that, in the first case, the leakage power of the current input, and in the second, the leakage power of the voltage input is added to the measuring result. As the leakage power of the current input may increase up to ~2 W at 10 amp versus a leakage power of the voltage input of 0.5 W at 1000 V, it is preferable to use the second method. It is used for the further diagrams, also in Aron and 3-phase measurements. For special applications such as active current sensors without power loss or higher leakage power at the voltage input with the “star point adapter,” method 1 is preferable.

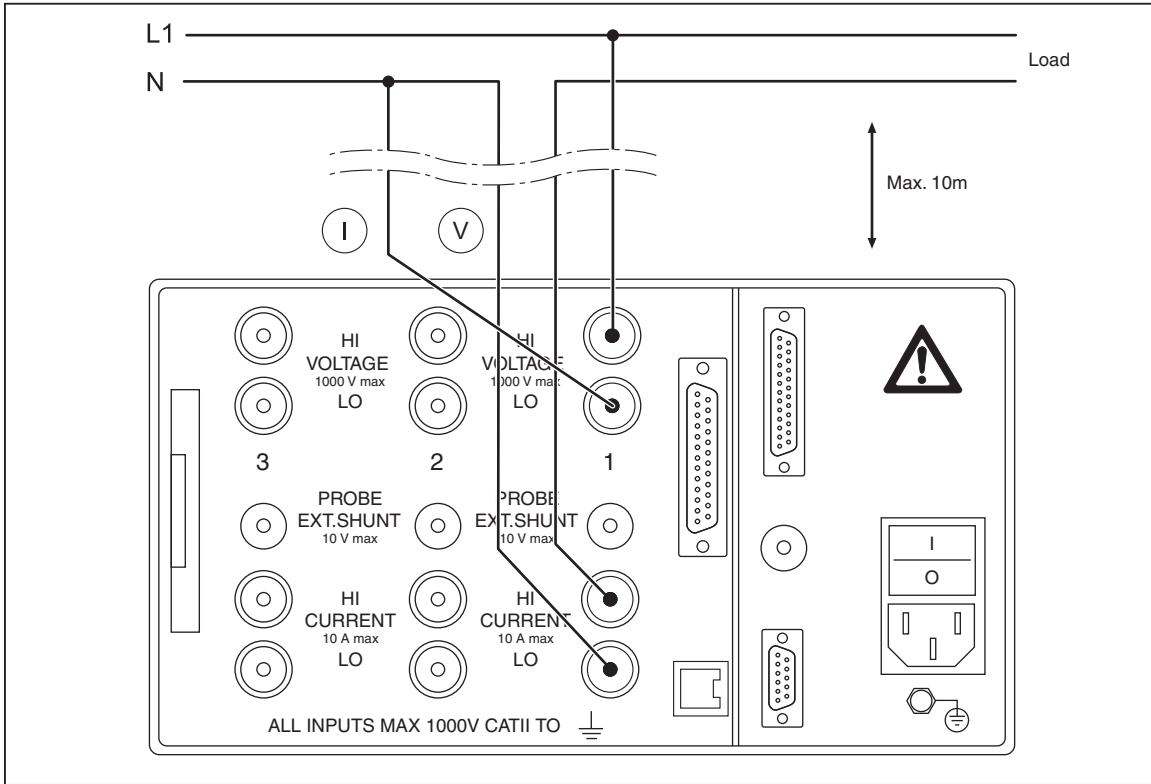

esn009.eps

Figure 5-1. Phase Measurement-Current Input and Mains

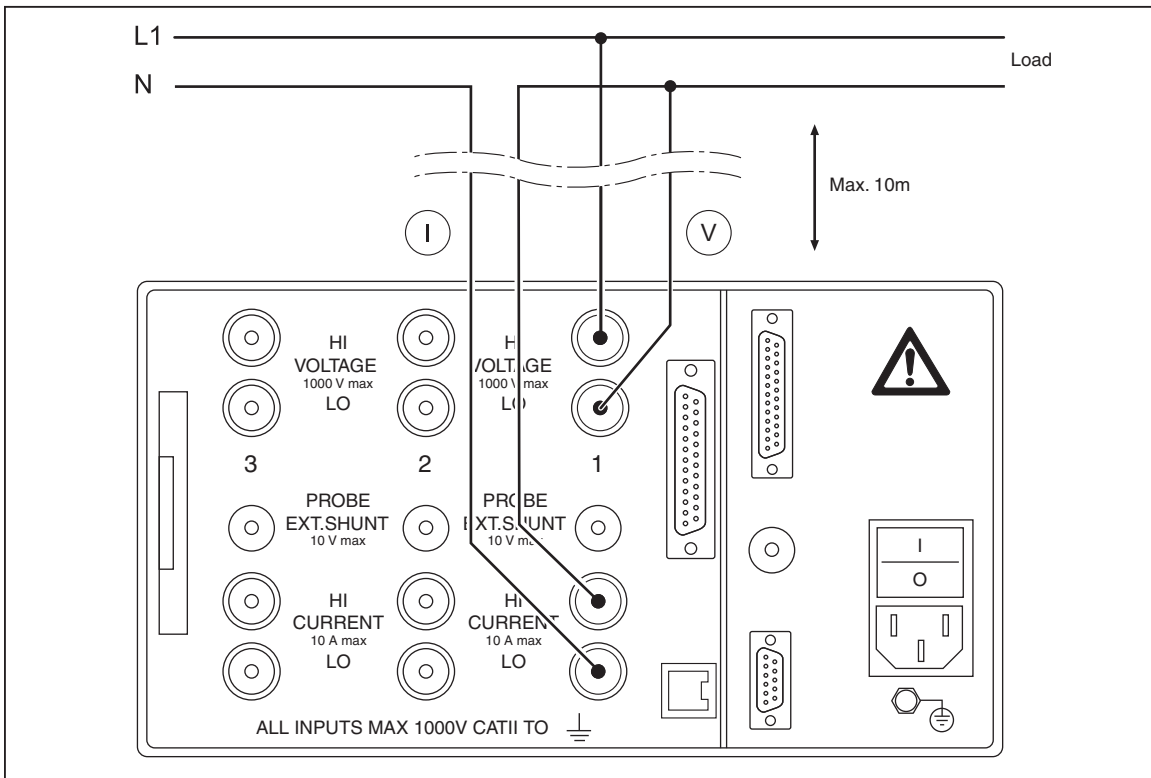

esn009a.eps

Figure 5-2. Phase Measurement-Current Input and Load

Measurement with Shunt

The connecting leads to the shunts should be as short as possible in order to prevent interference and noise voltages.

Warning

To avoid possible electric shock or personal injury:

- Do not touch sensing terminals. The sense terminals at the shunts are powered with the same voltage as the power connections.
- Shunts are not isolated. Never touch the sense terminals at the shunts.
- Risk of injury when touching connections, internal circuits, and measuring devices that are not earthed.
- Always adhere to the instructions regarding the connection sequence (see Chapter 5, “Connecting Sequence”).

Where the current to be measured exceeds the rating of the direct current connection, an external triaxial shunt should be used, see Figure 5-3. Fluke triaxial shunts are recommended as they provide high accuracy across the full frequency range. Standard linear shunts may produce excessive errors due to the possible presence of high frequency that components experience with electronic loads. The NORMA internal shunt is optimized for such loads.

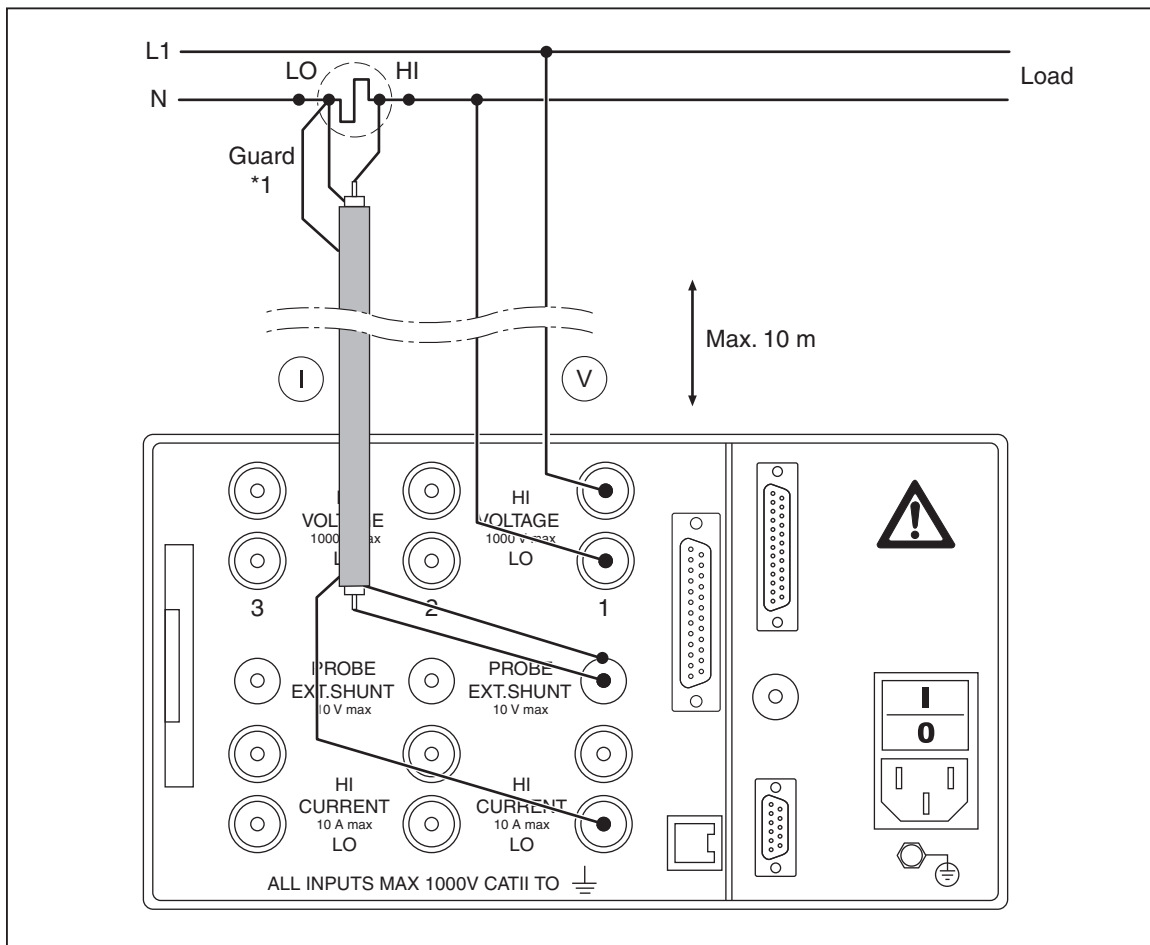

Figure 5-3. Measurement with Shunt

esn010.eps

Note

In Figures 5-3, 5-6, and 5-9, Fluke recommends using MCS measuring leads for triaxial shunts and MCP leads for planar shunts. Triaxial shunts are equipped with guard connectors in the plugs and planar shunts are equipped with guard sockets.

Measurement with Voltage and Current Transducer

Figure 5-4 shows the connections for measurements with a voltage and current transducer.

⚠ Caution

To prevent damage to the transducer due to overload, check transducer rating.

Note

Transducer errors limit the measuring bandwidth and reduce the intrinsic uncertainty.

⚠⚠ Warning

To avoid possible electric shock or personal injury:

- Risk of injury when touching connections, internal circuits, and measuring devices that are not connected to earth ground.
- Always adhere to the instructions regarding the sequence of connection (see Chapter 5, “Connecting Sequence”).

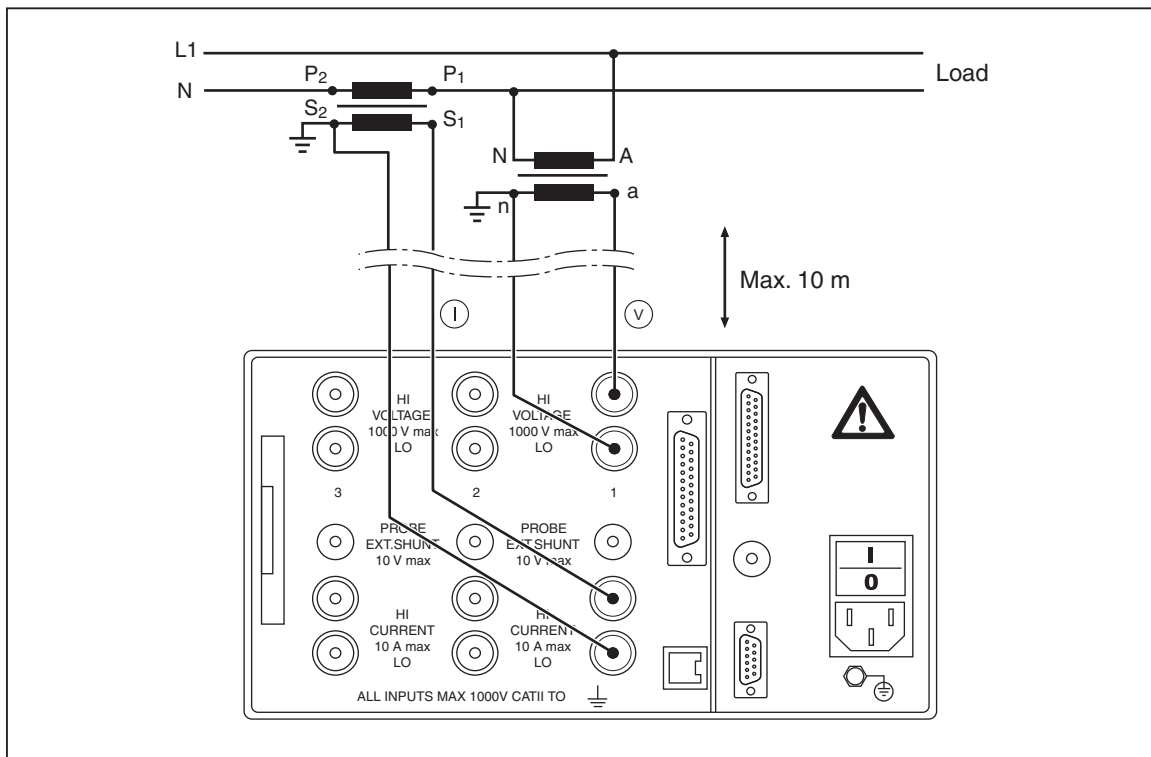

Figure 5-4. Voltage and Current Transducer Measurement

esn011.eps

Aron Circuit (2-Wattmeter Method, W2)

Direct Connection

The Aron circuit is only available for 3-wire networks, see Figure 5-5. It is only required to measure two phases (currents I1 and I2 in the following connection diagrams), as $I1+I2+I3$ must be 0.

Note

In most cases, the Aron circuit is not acceptable for measurements on inverters, as there are capacitive leakage currents from the windings to the housing.

- *Ensure that there is no overload at the current input of the Power Analyzer.*
- *If necessary, install appropriate fuses.*

To select the Aron, or 2-wattmeter, Method, go to **General Setup** and select **W2**. Select channels 2 and 3 for the connections. For more information, see Chapter 7, “Configuration.”

Scaling transformers for voltage and current may be used in this mode but care needs to be made in identifying the correct channel and measurement index information.

Note

The W2 mode is not provided for the second set of three phase inputs with the 4 or 6 channel versions of the NORMA 5000.

Warning

To avoid possible electric shock or personal injury:

- **Risk of injury when touching connections, internal circuits, and measuring devices that are not connected to earth ground.**
- **Always adhere to the instructions regarding the sequence of connection (see Chapter 5, “Connecting Sequence”).**

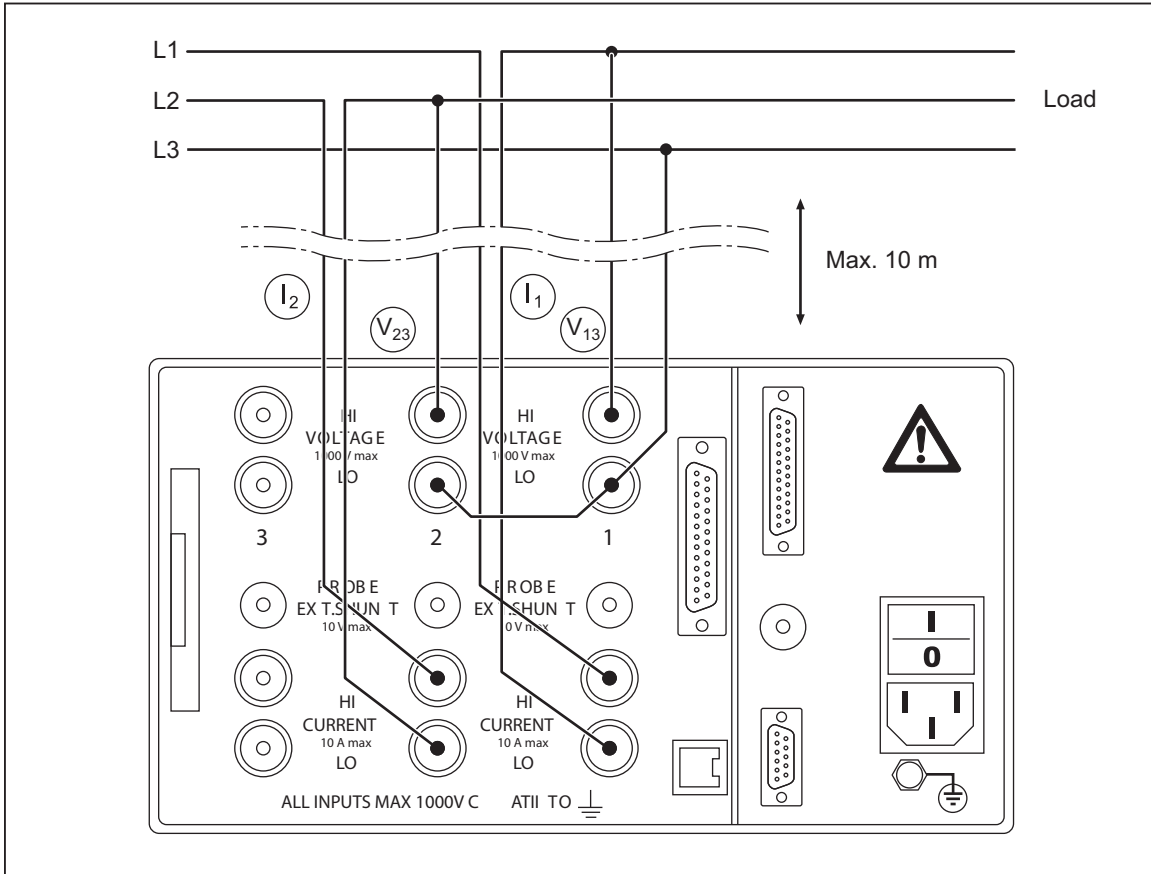

Figure 5-5. Aron Circuit-Direct Measurement

esn012.eps

Measurement with Shunt

The connecting leads to the shunts should be as short as possible in order to prevent noise voltages (see Figure 5-6).

Warning

To avoid possible electric shock or personal injury:

- Do not touch sense terminals. The sense terminals at the shunts are powered with the same voltage as the power connections.
- Shunts are not isolated. Never touch the sense terminals at the shunts.
- Risk of injury when touching connections, internal circuits and measuring devices that are not connected to earth ground.
- Always adhere to the instructions regarding the sequence of connection (see Chapter 5, "Connecting Sequence").

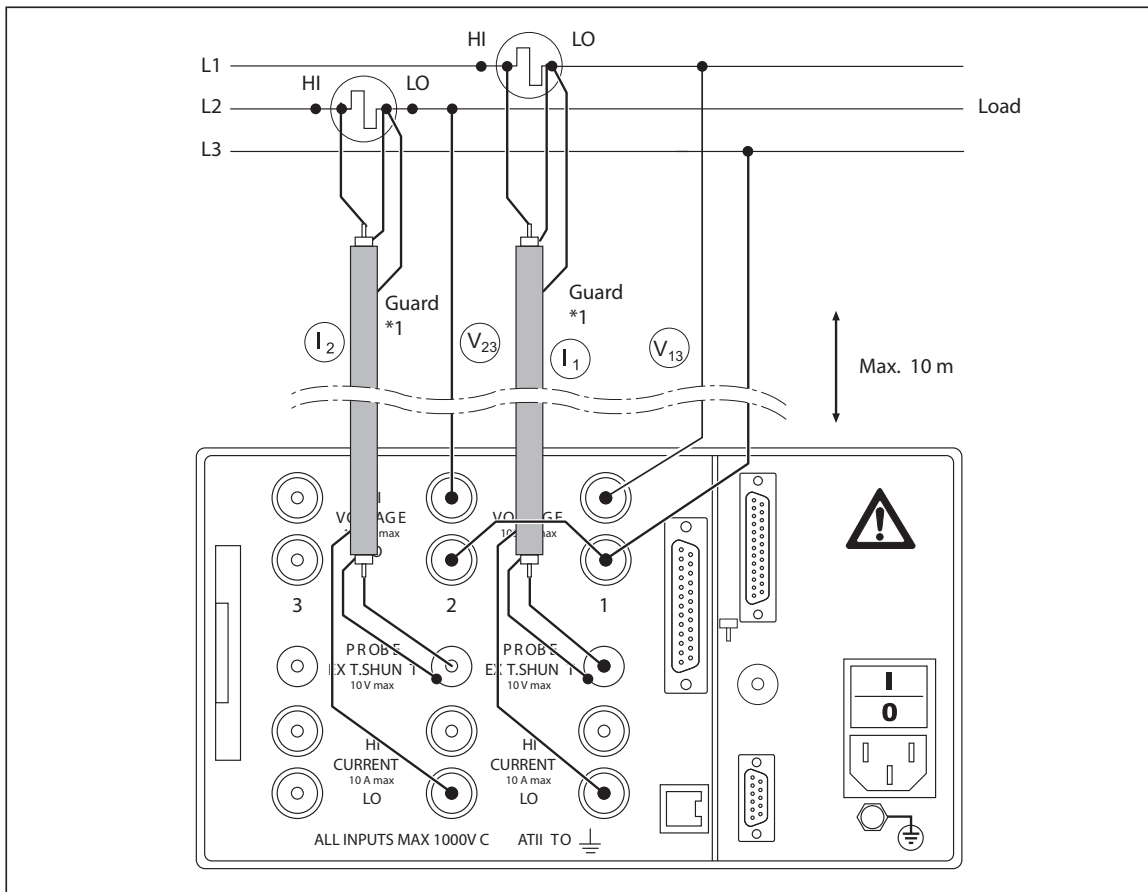

Figure 5-6. Aron Circuit-Shunt Measurement

esn013.eps

Measurement with Voltage and Current Transducer

Figure 5-7 illustrates the connections for measuring the Aron circuit with a voltage and current transducer.

⚠ Caution

To prevent damage to the transducer due to overload, check transducer rating.

Note

Transducer errors limit the measuring bandwidth and reduce the intrinsic uncertainty.

⚠⚠ Warning

To avoid possible electric shock or personal injury:

- **Risk of injury when touching connections, internal circuits and measuring devices that are not connected to earth ground.**
- **Always adhere to the instructions regarding the sequence of connection (see Chapter 5, “Connecting Sequence”).**

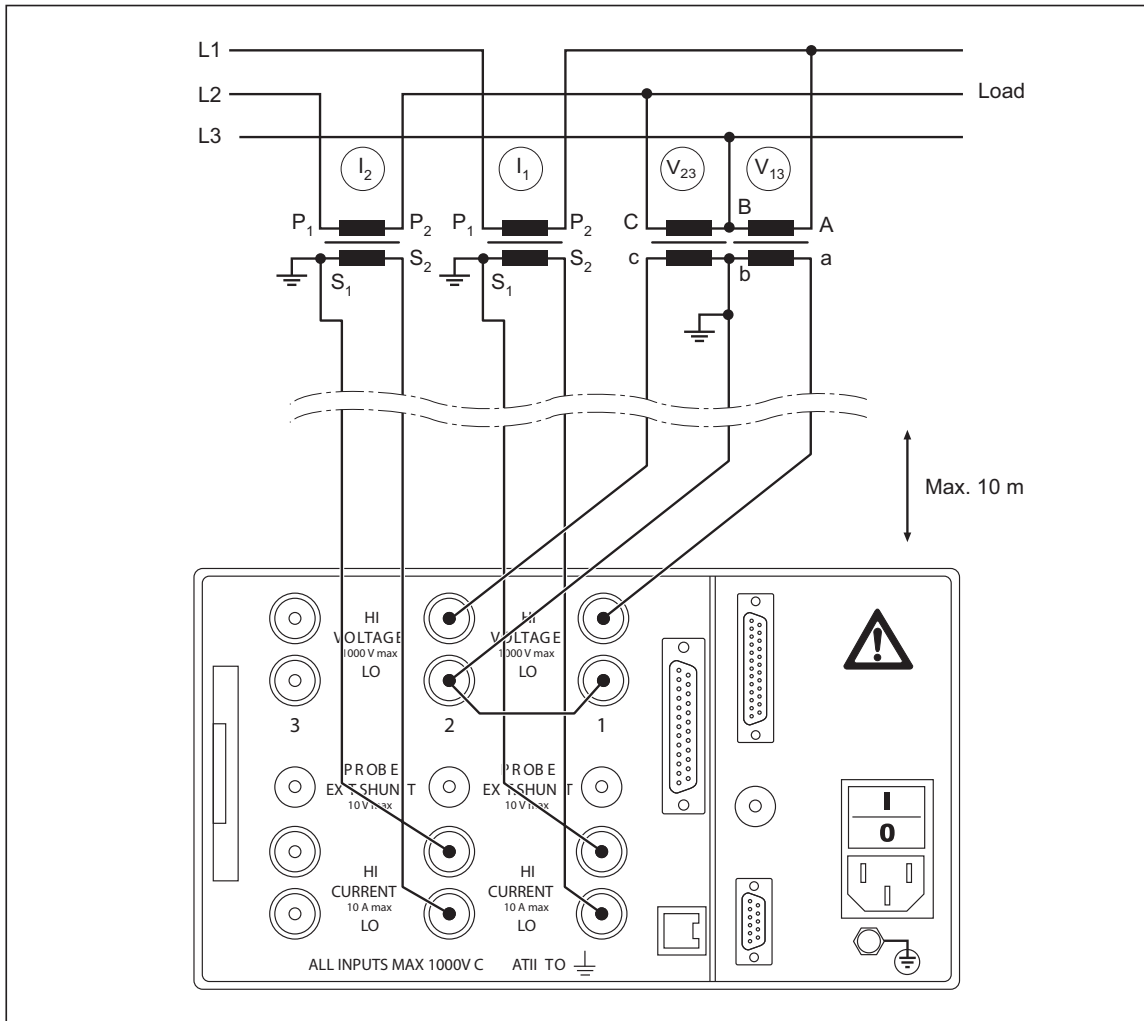

Figure 5-7. Aron Circuit-Voltage and Current Transducer Measurement

esn014.eps

3-Phase Measurement (W3)

Direct Connection

Figure 5-8 illustrates a direct connection for a 3-phase measurement. Ensure that there is no overload at the current input of the Power Analyzer. If there is a potential risk of overload at the current input, incorporate a shunt or transducer into the circuit. If necessary, install appropriate fuses.

To select the 3-phase (W2) method, go to **General Setup** and select **W3**. For more information, see Chapter 7, “Configuration.”

Warning

To avoid possible electric shock or personal injury:

- Risk of injury when touching connections, internal circuits and measuring devices that are not connected to earth ground.
- Always adhere to the instructions regarding the sequence of connection (see chapter 5, Connecting Sequence).

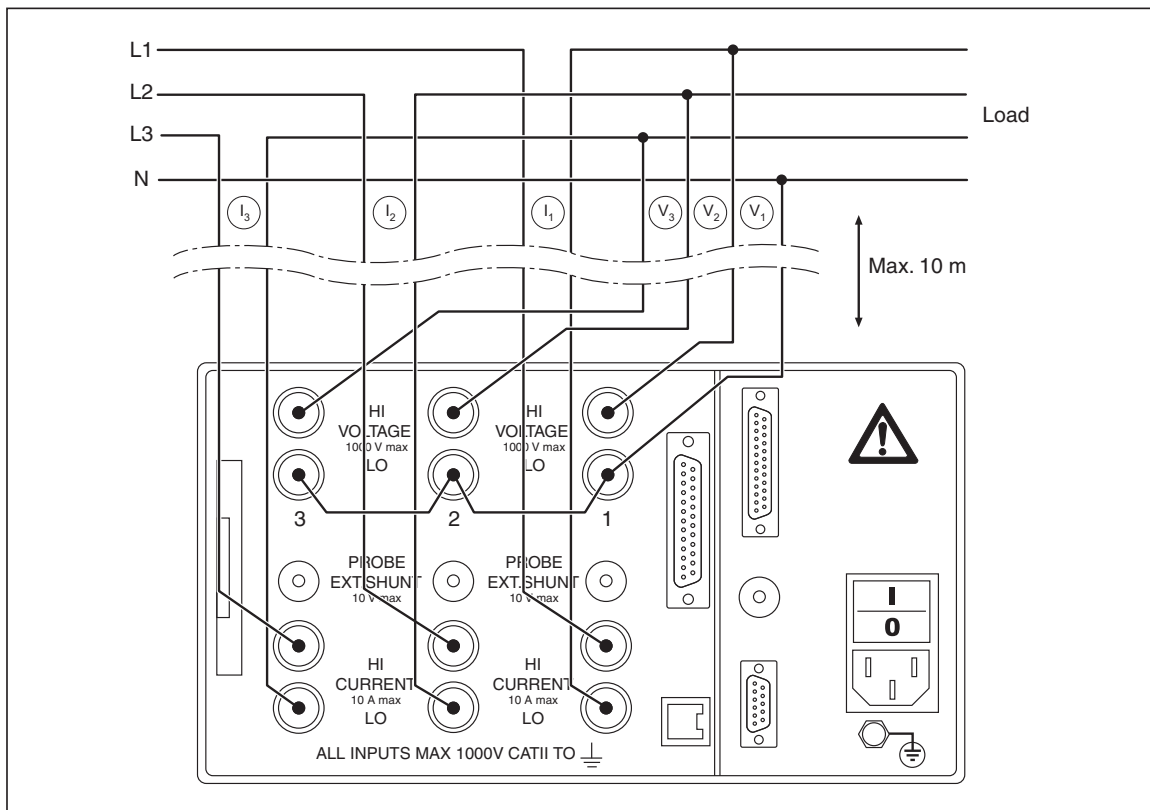

Figure 5-8. 3-Phase Measurement-Direct Connection

esn015.eps

Measurement with Shunt

Figure 5-9 illustrates the connections for a 3-phase measurement using a shunt. The connecting leads to the shunts should be as short as possible in order to prevent noise voltages.

Warning

To avoid possible electric shock or personal injury:

- Do not touch sense terminals. The sense terminals at the shunts are powered with the same voltage as the power connections.
- Shunts are not isolated. Never touch the sense terminals at the shunts.
- Do not touch connections, internal circuits, and measuring devices that are not connected to earth ground.
- Always adhere to the instructions regarding the sequence of connection (see Chapter 5, “Connecting Sequence”).

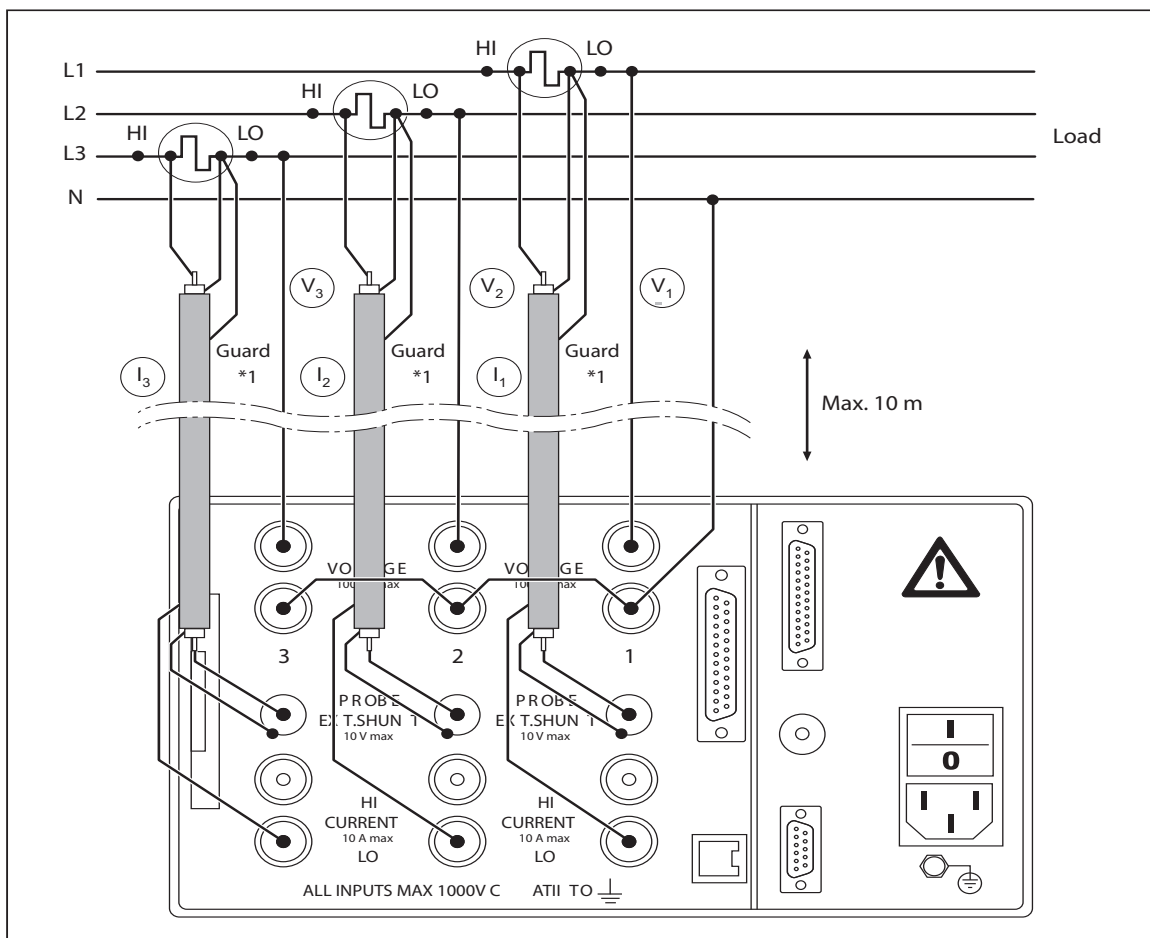

Figure 5-9. 3-Phase Measurement with Shunt

esn016.eps

Measurement with Voltage and Current Transducer

Figure 5-10 illustrates the connections for a 3-phase measurement with a voltage and current transducer. In 4-wire power systems, the common (N) of the 3 voltage transducers is connected to the neutral line. In 3-wire power systems, the common (N) of the 3 voltage transducers is left open to create a star point. Alternately, you can connect to the star point of a wye-connected load or to earth if the internal star point of the power system is connected to earth.

⚠ Caution

To prevent damage to the transducer due to overload, check the transducer rating.

Note

Transducer errors limit the measuring bandwidth and reduce the intrinsic uncertainty.

⚠⚠ Warning

To avoid possible electric shock or personal injury:

- **Risk of injury when touching connections, internal circuits and measuring devices that are not connected to earth ground.**
- **Always adhere to the instructions regarding the sequence of connection (see Chapter 5, “Connecting Sequence”).**

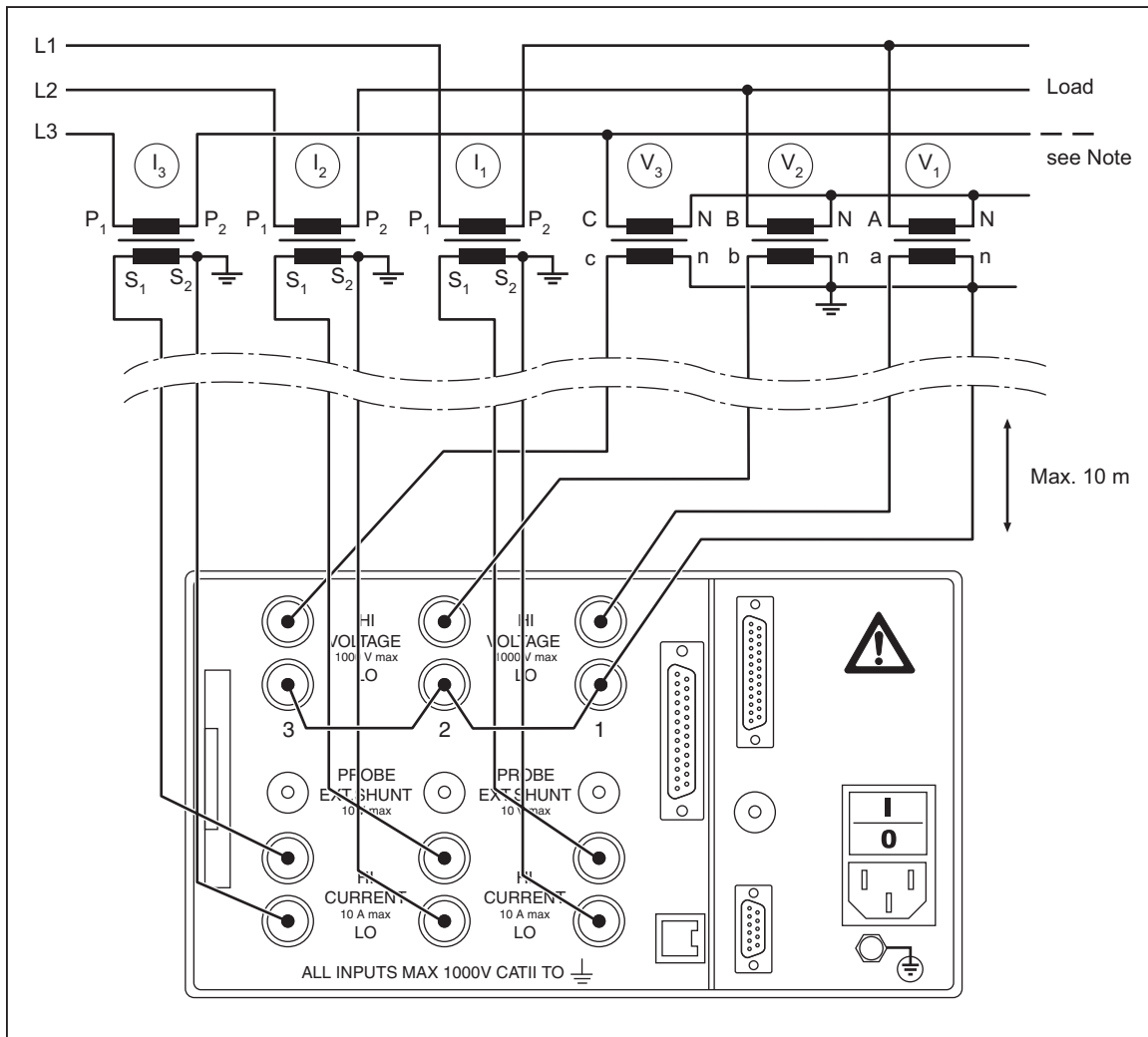

Figure 5-10. 3-Phase (W3) Voltage and Current Transducer Measurement

esn077.eps

Note

- *In 4-wire power systems, is the common “N” of the 3 voltage transducers connected to the neutral line?*
- *In 3-wire power systems, is the common “N” of the 3 voltage transducers left open creating a star point?*
- *Or, it might be connected to the star point of a wye-connected load.*
- *Or, it might be connected to earth if the internal star point of the power system is connected to earth also.*

Measurement with Star Point Adapter

In systems with three voltage wires, the three wires should be connected to the HI terminal and the LO terminals should be connected together.

However, in high frequency switching electronics systems such as drives, inverters, and UPS, this method has additional errors due to high frequency components being shunted to the ground connection. To compensate for this error, use the star point adapter, see Figure 5-11.

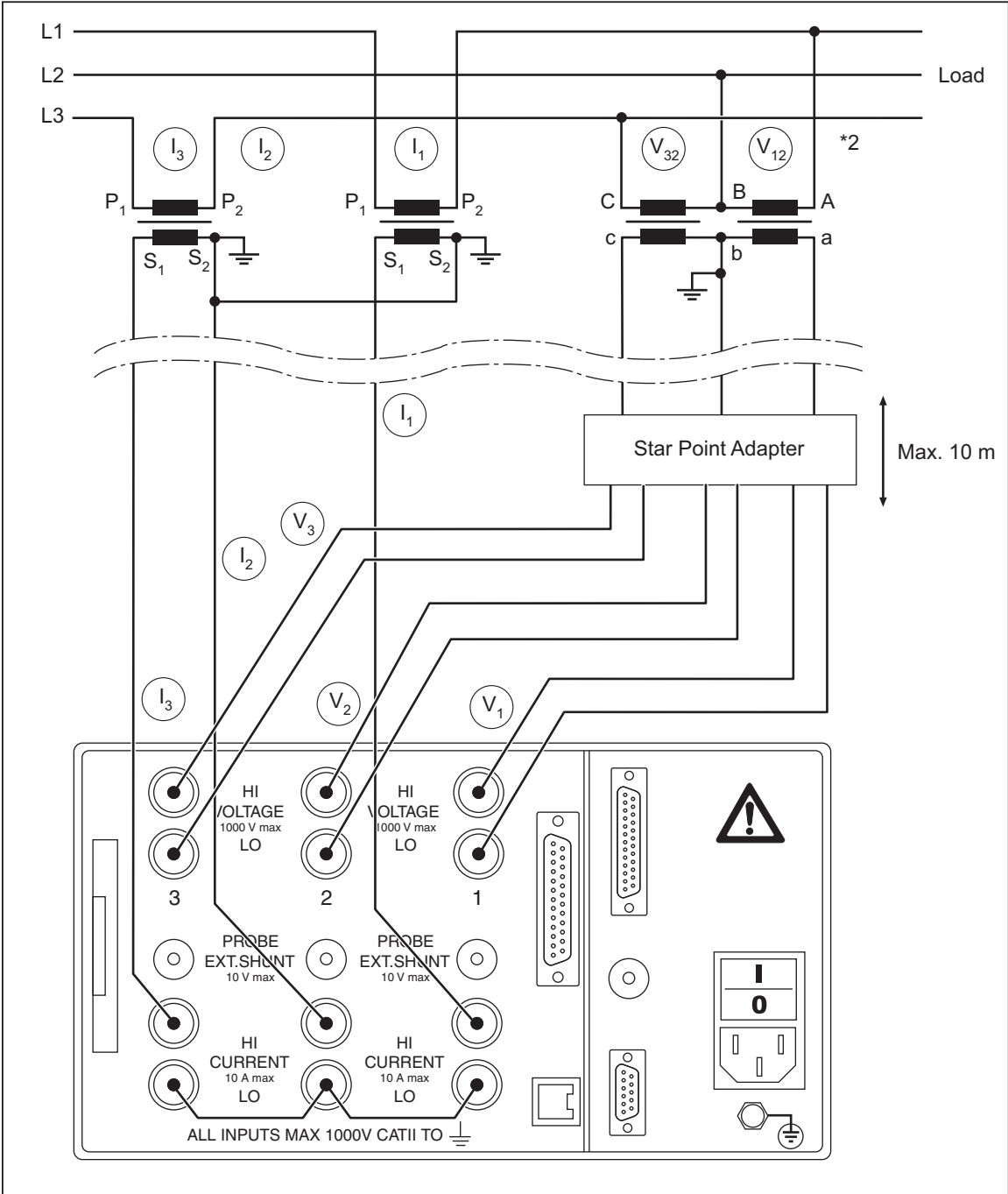

Figure 5-11. 3-Phase Measurement with Star Point Adapter

esn078.eps

Chapter 6

Simple Measurement

Title	Page
About this Chapter	6-3
Connection to Circuits	6-3
Configuration	6-3
Measuring	6-4

About this Chapter

This chapter contains an introduction to the measuring procedures that can be carried out with the Power Analyzer, based on a sample measurement. The example used here is a measurement at the frequency converter with a fundamental below 100 Hz.

Connection to Circuits

Connect the outputs of the frequency converter to the current and voltage channels of the Power Analyzer (see the section “3-Phase Measurement (W3)” in Chapter 5, “Direct Connection”).

Configuration

To select the configuration:

1. Switch on the Power Analyzer.

1:W3		PI R	309.9ms	f1u	22.588 Hz	10:47:32
U1	100.0 V \approx	U ₁	rms	32.00	V	
I1	300.0 mA \approx					
U2	100.0 V \approx	I ₁	rms	161.53	mA	
I2	300.0 mA \approx					
U3	100.0 V \approx	P ₁	1.200	W		
I3	300.0 mA \approx					
		S ₁	5.17	VA		
		Q ₁	5.03	Var		
		λ_1	0.2322	ind		
RS	Phase 1, Main					
LCD +	LCD -	User	el/mech	Detail	rms/h01	

esn017.tif

2. Ensure that factory configuration 1:W3 is loaded (see Chapter 7, "Load Configuration").

The settings for the factory configuration 1:W3 are as follows:

- Low-pass filter on and set to 100 Hz
- Average time set to approximately 300 ms, depending on the measured frequency
- Synchronization source is U1

Measuring

Press measuring key **WAV** three times. The rms values for power in channels 1 through 3 are displayed.

1:W3		PI	309.9ms	f1u 22.585 Hz	10:49:12
U1 100.0 V \approx	P ₁	1.177	W		
I1 300.0 mA \approx					
U2 100.0 V \approx	P ₂	1.143	W		
I2 300.0 mA \approx					
U3 100.0 V \approx	P ₃	1.150	W		
I3 300.0 mA \approx					
	λ_1	0.2292	ind		
	λ_2	0.2263	ind		
	λ_3	0.2259	ind		
RS	Power, Phase 1/2/3				
LCD +	LCD -	User	el/mech	f	rms/h01

esn018.tif

The numbers in subscript for U or I (in the example, U₁ or U₂) indicate the respective channel.

Note

As the Power Analyzer requires a complete voltage and current cycle for an accurate measurement; a full period is automatically added to the average time of 300 ms of configuration 1:W3, and the new average time is displayed (for example: 309.9 ms at 22.585 Hz, corresponding to seven periods).

Chapter 7 Configuration

Title	Page
Set Up for Measuring.....	7-3
Configuration.....	7-3
Five Steps.....	7-4
Call up General Setup and System Information Screen.....	7-4
General Setup	7-4
System Information Screen	7-4
Load Configuration.....	7-5
Load Configuration (Optional).....	7-5
Modify Loaded Configurations	7-5
Configure Method.....	7-5
Configure Data Transfer to Printer and PC.....	7-5
Configure External Printer	7-6
Configure Interface to PC.....	7-7
Configure RS 232	7-7
Configure GPIB Address.....	7-8
Configure Ethernet	7-8
Configure Average Time and Synchronization	7-9
Timing & Sync Setup	7-9
Set Average Time	7-10
Select Synchronization Source	7-11
Set Trigger Level.....	7-11
Select Slope Direction	7-12
Select Low-Pass Filter	7-12
Configure Signal Output.....	7-12
Adjust Date and Time	7-13
Configure Current and Voltage Channels.....	7-13
Current Channel Setup	7-14
Configure Input Range	7-15
Automatic Range Adjustment (Auto)	7-15
Manual Range Adjustment (Range).....	7-15
Configure Scale	7-15
Configure Coupling.....	7-16
Configure Filter	7-17
Voltage Channel Setup	7-17
Switch Current Input to External Input (BNC).....	7-18

Switch Current Input	7-18
Configure Auto-Range Selection.....	7-18
Configure Scale	7-18
Integration Function Configuration	7-19
Integration Setup	7-19
Select Integration Value	7-21
Configure Status	7-21
Configure Start	7-22
Configure Stop.....	7-23
Save Configuration	7-23
Delete Configuration.....	7-24
Undersampling and Aliasing.....	7-24

Set Up for Measuring

Prior to measuring, you must configure the default settings, adjust channels, measuring ranges and times, and synchronize current and voltage sources.

If you wish to reapply certain settings at a later stage, you must save the configuration. You have the option to save up to 15 user-defined configurations, which are automatically assigned the names 10:USER to 24:USER.

Configuration

When first switching on the Power Analyzer, factory configuration 1 and 2:W2 is used. This configuration is suitable for measurements with fundamentals below 100 Hz (average time 300 ms, synchronization source U1, low-pass filter 100 Hz).

Mode W3 is the standard configuration for three phase, 3-wattmeter measurement and single phase measurement. Channels 1, 2, and 3 are used for three-phase measurements in a 3-channel instrument, considering three-channel average values and totals. In 4-channel instruments, channel 4 acts as an independent single channel. In 6-channel configurations, the W3 connection operates as two independent three-phase systems.

In 4- or 6-channel instruments where the W2 configuration is selected, the channels higher than 3 operate as the W3 configuration.

Note

You have the option to modify the settings for configuration 1:W3. If you wish to save the new settings, you must do this in a new configuration. Default configuration 1 and 2:W2 cannot be overwritten. You may save new settings in the process or at the end of the configuration procedure. Settings that have not been saved are lost when the device is switched off or when a different configuration is loaded.

You may:

- Modify configuration 1:W3 loaded upon startup of the device
- Load an existing configuration
- Create a new configuration
- Delete or modify an existing configuration

The Power Analyzer features the configuration menus listed in Table 7-1.

Table 7-1. Configuration Menus

Configuration menu	Description
General Setup	Interfaces, printer output
Timing and Sync Setup	Average time and synchronization
Clock Setup	Date and time
Current Channel Setup	Current channels 1 through 6
Voltage Channel Setup	Voltage channels 1 through 6
Motor / Generator Setup	PI1 process interface inputs
Analog Output Setup	PI1 process interface outputs
Integration Setup	Integration function / energy

Five Steps

To set up a configuration, complete the following steps:

- Call up General Setup (optional)
- Configure current and voltage channels
- Configure average time and synchronization
- Configure data transfer to printer and PC
- Save configuration

For instructions on how to configure the PII process interface, please refer to Chapter 9, "NORMA Analog Interface (Optional)."

For instructions on how to delete a configuration, please refer to chapter 7 "Delete Configuration."

Call up General Setup and System Information Screen

General Setup

1. Switch on the Power Analyzer and the start screen is displayed.
2. Move the cursor to the menu item General Setup that shows the name of the currently loaded configuration (in the example following, 1:W3).
3. Press **Enter**. The General Setup menu is displayed.

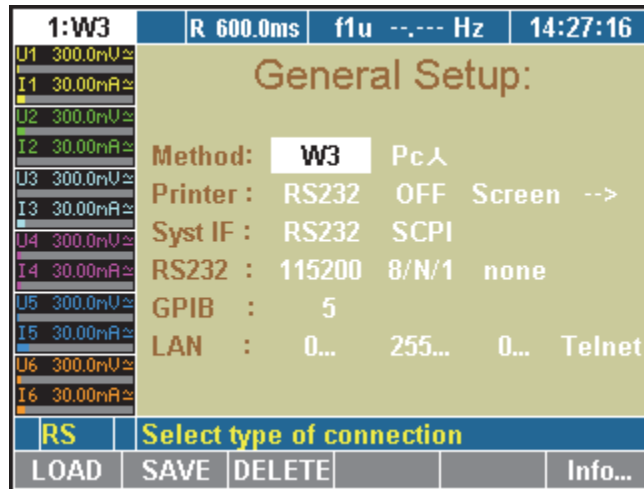

esn019.gif

System Information Screen

From the General Setup menu:

1. Press function key **Info....** The System Info menu is displayed.

This screen shows the basic information about the Power Analyzer:

System	Device type and sample rate
Phases	Type and number of equipped power phases
Options	Equipped interfaces and options
Serial	Serial number
Version	Firmware version

Load Configuration

Note

If you have not set up and saved a new configuration before, you are currently working with one of the predefined configurations, 1:W3 (factory default) or 2:W2.

Load Configuration (Optional)

1. Proceed as described in Chapter 7, "Configure Data Transfer to Printer and PC."
2. Press function key **LOAD**.
A list showing all existing configurations is displayed.
3. Select a configuration and confirm by pressing **Enter**.
The name of the loaded configuration, for example, 10:USER, is displayed in menu item General Setup. W2 configurations are marked as "User2."

Modify Loaded Configurations

To modify the loaded configuration, proceed as described in the following sections.

Configure Method

Mode W3 is for standard power measurement as single phase or 3-phase. Mode W2 is for the 2-wattmeter method (Aron or Blondel) in 3-wire/3-phase power systems. For more details, see the different applications and connection diagrams in Chapter 7.

Phase-to-phase voltage ($P_{c\Delta}$) or phase voltage (P_{cY}) is used for transformer measurement. The "Corrected Power" is a useful value for measurement of transformer losses. The calculation, Active Power \div Corrected Power, has to be done depending on the type of the transformer by using P_{cY} or $P_{c\Delta}$ (see Chapter 10). In W2 mode, it is fixed to $P_{c\Delta}$.

Configure Data Transfer to Printer and PC

If you wish to use an internal or external printer, or if you intend to connect a PC, you must configure the parameters for the data exchange. This procedure consists of the following steps:

- Configure external printer
- Configure interface to PC
- Configure RS232
- Configure IEEE488 device address
- Configure network (LAN) addresses and protocol

Note

The actual selected interface is displayed in the Information row (see Chapter 3, "Operating Controls and Display"):

RS \rightarrow RS232, GP \rightarrow IEEE488, EN \rightarrow Ethernet, US \rightarrow USB

In the General Setup menu, define the following settings:

Line	Function
Printer	Configure printer
Syst IF	Configure interface to PC
RS232	Configure RS232 interface
GPIB	Configure IEEE488 device address
LAN	Configure network (LAN) addresses and protocol

The device can be equipped with an IEEE488 and Ethernet interface in addition to the serial RS232 interface.

Configure External Printer

Settings	Description
RS232 intern	Print via RS232 interface on external printer or use internal printer
On key Off	Printer activated Printer deactivated
Screen Num	Print screenshot Print numerical data
1/page 3/page	Print 1 screenshot per page Print 3 screenshots per page
PCL EPS 9p EPS 24p	PCL printer Epson 9-pin printer Epson 24-pin printer
S/W	Printing color is black/white

Note

The PCL setting is suitable for most inkjet printers.

1. Move the cursor to the field with the value you wish to change, enter the new value and confirm by pressing **Enter**.
2. Select the settings and confirm by pressing **Enter**.

The applied settings are shown in line Printer.

Configure Interface to PC

Settings	Description
RS232	Serial interface
GPIB	General Purpose Interface Bus: IEEE488 interface (optional)
LAN	Ethernet (LAN) interface (optional)
SCPI	Standard set of commands
D5255S	Previous set of commands (emulation)
D5255T	Previous set of commands (emulation)
D5255M	Previous set of commands (emulation)

1. Move the cursor to the field with the value you wish to change, enter the new value and confirm by pressing **Enter**.
2. Select the settings and confirm by pressing **Enter**.

The applied settings are shown in line Syst IF.

Note

A CD to install USB driver support to the PC is included in the delivery content. The USB interface is installed as a virtual COM port.

Configure RS 232

Settings	Description
115200 ...1200	Baud rate of serial interface
8/N/1 ...7/O/1	Data bits/parity/stop bits of the serial interface
none HW XON	Handshake (protocol) of the serial interface

Note

The factory settings of the RS232 interface are optimized for communication with a PC. We recommend adjusting the settings of the PC to suit these parameters.

Factory configuration: 115200 8/N/1 HW

1. On the connected PC, call up the Device Manager and open the dialog showing the settings for the serial port.
2. Adjust these settings to those of the Power Analyzer.

Note

If the cable connecting the two devices is extremely long, or if the PC is unable to handle data at the set rate, you might consider adjusting the RS232 settings for the Power Analyzer to those of the PC. To do this, proceed as follows:

1. Move the cursor to the first field in line RS232.
2. Enter the settings for baud rate, data bits/parity/stop bits and handshake and confirm by pressing **Enter**.
3. The new settings are now shown in the fields of line RS232.
4. Save the configuration settings by pressing the **SAVE** function key.

Configure GPIB Address

The general-purpose interface bus (GPIB) port is an IEEE488 interface. The IEEE488 interface works like an IP address in a network. The Power Analyzer is assigned a unique device address (numerical code) for communication on the GPIB port. If more than one Power Analyzer is used simultaneously in the network, the device address can be adjusted accordingly.

1. Move the cursor to the field in line GPIB and press **Enter**.
A list with available addresses is displayed.
2. Select an address that has not yet been assigned at the GPIB port and confirm with **Enter**.

The selected address is shown in line GPIB.

Configure Ethernet

Settings	Description
0.....	Device IP address
0.....	IP subnet mask address
0....	IP gateway address
Telnet	Transport protocol for standard Remote Control Commands (SCPI)
VNC®	Protocol for remote terminal server

Before the Ethernet interface can be operated properly, enter the correct network addresses and protocol.

1. Move the cursor to one of the address fields in line LAN and press **Enter**.
A window with a numeric entry field is displayed.
2. Enter the required IP address, IP netmask and IP gateway and confirm each by pressing **Enter**.
Address, netmask and gateway are shown in line LAN.
3. Select the LAN protocol to use and press **Enter**.
Telnet communicates with the device by its standard Remote Control command set, *VNC®* is a widely used protocol to show a device screen on a remote computer and control it by keyboard and mouse. VNC is a registered trademark of **RealVNC Ltd.**

4. Save the configuration settings by pressing the **SAVE** function key.
5. Press **Esc** to leave the entry field without changing the setting.

Note

The default address is 0.0.0.0 (factory settings). Addresses can only be entered in conjunction with IP network addressing (for example, address 193.0.255.4).

Note

Network addresses are available from your network administrator.

Configure Average Time and Synchronization

This configuration concerns important parameters required for the synchronization of the measuring procedure. To configure these parameters, proceed as follows:

- Call up “Timing & Sync” Setup
- Enter average time
- Select synchronization source
- Set trigger level
- Select slope direction
- Select low-pass filter
- Configure signal output

Timing & Sync Setup

Move the cursor to menu item **Timing & Sync Setup** and press **Enter**.

The “Timing & Sync Setup” menu is displayed. The value in column Tavg[s] is highlighted.

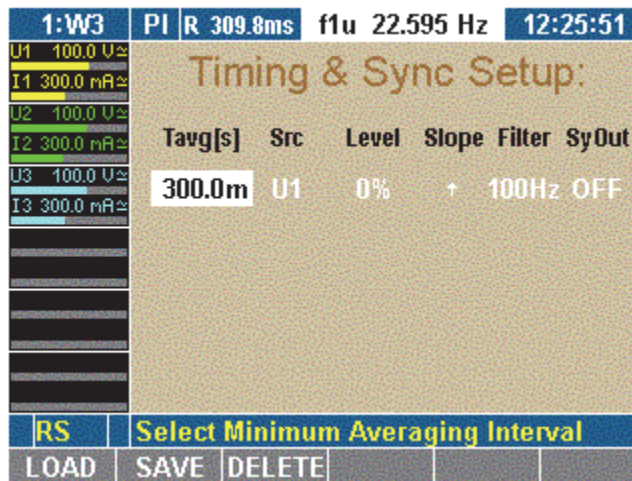

esn020.gif

In the Timing & Sync Setup menu, define the following settings:

Column	Settings	Description
Tavg[s]	15 ms... 3600 s	Minimum average time (in seconds)
Src	U1 / I1 ... U6 / I6 ext Off	Synchronization source Fixed average time
Level	-150 % ... +150 %	Trigger level (in % of measuring range)
Slope	↑ or ↓	Slope direction
Filter	10 kHz 1 kHz 100 Hz off	Synchronization filter (filter is not in signal path)
SyOut	On Off	Signal output enabled Signal output disabled (at Sync Ext output)

Set Average Time

The average time is a multiple of the period of the voltage of current source. The settings are automatically adjusted during measuring. For example: the average time is set to 19 ms; at a frequency of 50 Hz, it is automatically adjusted to 1 period, that is, 20 ms.

Note

Short average times are useful, if you wish to analyze individual periods, measuring even minute interferences. With long average times, for example 300 ms at 50 Hz, short-term interferences are not shown.

Value in column Tavg[s] is highlighted.

1. Press **Enter**.
A window with a numerical entry field is displayed.
2. Enter the first digit of the average time and confirm by pressing **Enter**.
Repeat the above step for the other digits.



esn021.eps

The measuring time is entered in seconds. For exponential powers, use the following keys on the numerical keypad:

Exponential Power	Key
micro [10 ⁻⁶]	μ
milli [10 ⁻³]	m
kilo [10 ³]	k
mega [10 ⁶]	M

1. Enter the exponential power and confirm with Enter.
2. Move the cursor to the return field of the calculator and press Enter.
The average time is shown in column Tavg[s].
3. Save the configuration settings by pressing the **SAVE** function key.

Select Synchronization Source

The synchronization source determines the frequency on which the analysis is based. In factory configuration 1:W3, the synchronization source is U1, as this signal tends to be reliable in most cases.

The following options are available:

- Input at device (channel 1 through 6), current or voltage respectively (U1 through U6, I1 through I6).
- Ext for external synchronization signal (connection to port for external synchronization signal).
- OFF, if no synchronization source is used (such as measuring of direct current).

Note

To measure the start up of a machine, you might opt for an external synchronization signal (0.2 Hz to sample rate, max. 50 V), as there is otherwise no signal at the beginning of the measuring procedure, and thus no measured values.

Value in column Src is highlighted.

1. Press **Enter**.
2. Select a source or OFF and confirm by pressing **Enter**.
The selected source or OFF is shown in column Src.
3. Save the configuration settings by pressing the **SAVE** function key.

Set Trigger Level

The trigger level is in percentages of the measuring range, and measured from the end value of the range. In factory configuration 1:W3, the trigger level is set to 0 %.

Note

By increasing the trigger level, the level of the average is also increased. If there are several positive slopes in the zero crossing, a higher modulated signal can be triggered.

Value in column Level is highlighted.

1. Press **Enter**.
2. Enter the desired power and confirm by pressing **Enter**.
The value is displayed in column Level.
3. Save the configuration settings by pressing the **SAVE** function key.

Select Slope Direction

The value entered here determines the zero crossing at which the measurement begins, that is, zero crossing with positive or with negative slope. In factory configuration 1:W3, a positive slope is set. The arrow symbol "↑" indicates to a positive slope; symbol "↓" indicates a negative slope.

Highlight the value in column Slope.

1. Press **Enter**.
2. Select the desired arrow symbol and confirm by pressing **Enter**.
The selected arrow symbol is shown in column Slope.
3. Save the configuration settings by pressing the **SAVE** function key.

Select Low-Pass Filter

The low-pass filter enables you to modify signals with high harmonic content (such as, PWM) so that they are synchronized to the resulting fundamental. This ensures that all measured values refer to this fundamental. The low-pass filter is not located in the signal path so that the input signal is not in any way interfered with.

Value in column Filter is highlighted.

1. Press **Enter**.
2. Select a value or OFF, depending on the expected fundamental, and confirm by pressing **Enter**.
The entered value, or OFF, is shown in column Filter.
3. Save the configuration settings by pressing the **SAVE** function key.

Configure Signal Output

The value in column SyOut is highlighted.

1. Press **Enter**.
2. To activate output, select **ON**.
3. To deactivate output, select **OFF**.
4. Confirm by pressing **Enter**.
The entered value is shown in column SyOut.
5. Save the configuration settings by pressing the **SAVE** function key.

Note

The synchronization output is connected at the Sync-BNC plug on the backside of the unit. The output signal is a TTL pulse with 5 Volt.

Note

The BNC can be used either as input or output. As soon as the BNC plug is switched to input (EXT sync source or OFF selected), the sync output menu is automatically switched to OFF (disabled).

Adjust Date and Time

Note

Normally, date and time must be set only once, as they do not change with different configurations.

Adjust date and time with these steps:

1. Move the cursor to menu item Clock Setup and press **Enter**.
The Clock Setup menu is displayed. The value in column Year is highlighted.

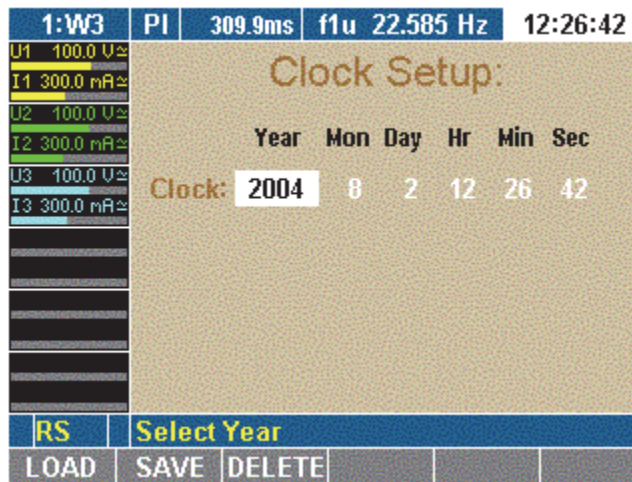

esn022.gif

2. Press **Enter**, select a year and confirm with **Enter**.
The selected year is displayed.
3. Move the cursor to the next field and repeat the above step until the correct date and time are shown.

The menu field Clock Setup shows the time in hours, minutes and seconds.

Configure Current and Voltage Channels

Prior to each measurement, you must configure the device inputs (channels). The following example explains the configuration procedure for current channel I1: The other current and voltage channels can be configured in the same way.

The configuration procedure consists of the following steps:

- Call up Current Channel Setup
- Configure input range
- Configure scale
- Configure coupling
- Configure anti-aliasing filter
- Call up Voltage Channel Setup

Current Channel Setup

Move the cursor to the status display of current channel I1 and press **Enter**.

The Current Channel Setup menu is displayed. The first field in column Auto of line I1 is highlighted.



In the Current Channel Setup menu, define the following settings:

Column	Settings	Description
Ch	I1 ... I6	Select input (channel)
Auto	ON OFF	Automatic range adjustment activated ... deactivated
Range	30 mA ... 10 A 30 mV ... 10 V	Measuring range (in ampere or volt)
Scale	Scale factor and A/V ratio	Scale for external probes/converters
Coup	AC DC	Coupling
Filter	ON OFF	Filter activated ... deactivated

Configure Input Range

You have the option to select automatic range configuration for the connected current source (Auto). Alternatively, you can configure the range manually (Range).

With automatic configuration, the Power Analyzer determines and selects the correct range for the connected current source.

Automatic Range Adjustment (Auto)

First field in column Auto is highlighted.

1. Press **Enter**.
2. Select **ON** and confirm by pressing **Enter**.
The selected settings are shown in column Auto.
3. If you wish to configure all three current channels in this way, press **Set All**.
All channels are now set to ON.
4. Save the configuration settings by pressing the **SAVE** function key.

Manual Range Adjustment (Range)

To manually configure the range for I1, enter the range in amperes or, if shunts are used, in volts.

First field in column Auto is highlighted.

1. Press **Enter**, select **OFF** and confirm by pressing **Enter**.
Automatic range adjustment is now disabled.
2. Move the cursor to the value in column Range and press **Enter**.
3. Select a value in amperes; if you use a shunt, select a value in volts.

Note

When a value in volt is entered, automatic configuration (Auto) is set to Off. Below Scale, option menu A/V is displayed.

1. Confirm by pressing **Enter**.
The settings are shown in column Range. Off is displayed in column Auto.
2. To configure all three current channels in this way, press **Set All**.
3. Save the configuration settings by pressing the **SAVE** function key.

Configure Scale

If you intend to use a shunt or a probe, you must adjust the scale for the output of the measuring signal.

Note

The correct parameter settings are shown on the shunt or probe type plate.

You can either:

- Enter the transducer ratio (U over I) at the external current meters and instruct the device to calculate the final scale factor.
- Or enter the scale factor at the current transducer so that the final scale factor can be calculated.

The parameters of the formula must be entered as follows:

- Scale factor x transducer ratio, whereby:
 - Scale factor is generally "1.0000" (one).
 - Transducer ratio is current (in amperes) to voltage (in volts).

Note

*If you select **Set All** to apply the configuration to all channels, only the scale factor is transferred. If shunt values U/I are entered, the scale factor is always 1, and Set All is not available. If probes are used, it is generally easier to enter the transducer ratio, and Set All is thus not recommended.*

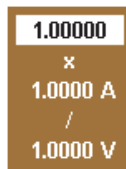

esn024.tif

1. Move the cursor to the value in column Scale and press **Enter**.
A dialog window showing the scale formula is displayed.
2. Select a value for each parameter and confirm by pressing **Enter**.
The settings are shown in column Scale.
3. Save the configuration settings by pressing the **SAVE** function key.

Configure Coupling

By configuring the coupling, you determine the current you wish to analyze. Select AC to analyze alternating currents; select DC to analyze direct and alternating current.

1. Move the cursor to the field in column Coup and press **Enter**.
The options AC and DC are displayed.
2. Select **AC** or **DC** and confirm with **Enter**.
The settings are shown in column Coup.
3. If you wish to configure all three current channels in this way, press **Set All**.
4. Save the configuration settings by pressing the **SAVE** function key.

Configure Filter

The anti-aliasing filter is located in the measuring channel. It is a prerequisite for the correct analysis of Fast Fourier Transform (FFT) data. The default configuration is ON. The anti-aliasing filter has a cut-off frequency of 1/10 of the sampling frequency. At half the sampling frequency, no signal reaches the A/D converter.

Note

*For broadband numerical measurements in lighting technology, set the filter to **OFF**.*

If measurements at high frequency are made without filter, it is not possible to correctly analyze the signals, due to aliasing. Please refer to the section, "Undersampling and Aliasing", in Chapter 7.

1. Move the cursor to the value in column Level and press **Enter**.
The options AC and DC are displayed.
2. Select the desired value and press **Enter**.
The entered value is shown in column Level.
3. If you wish to configure all three current channels in this way, press **Set All**.
4. Save the configuration settings by pressing the **SAVE** function key.

Voltage Channel Setup

Call up Current Channel Setup.

Note

To configure the voltage channels, proceed as described for the current channels.

1. Press function key **U/I**.
The Voltage Channel Setup menu is displayed.

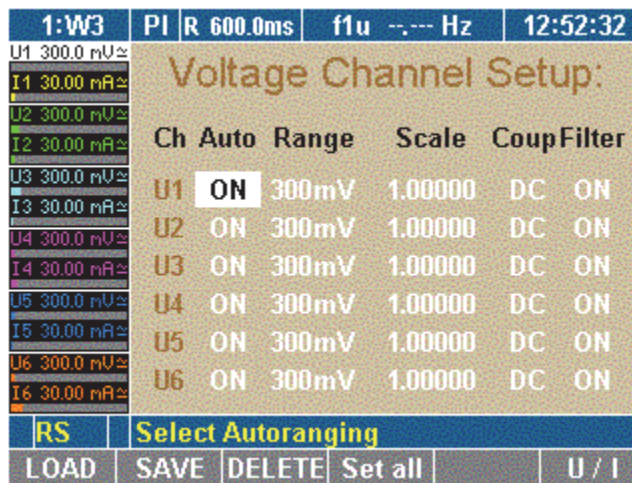

esn025.gif

2. Configure voltage channels 1 to 6.

Switch Current Input to External Input (BNC)

If you want to use an external shunt or probe you have to change the current input from direct measurement to the BNC input. This has to be done in the Current Channel Setup menu.

This procedure consists of the following steps:

- Call up Current Channel Setup
- Switch input
- Configure input range
- Configure scale

Switch Current Input

First field in column Range is highlighted.

1. Press **Enter**, select a voltage range (such as, 3 V) and press **Enter**.

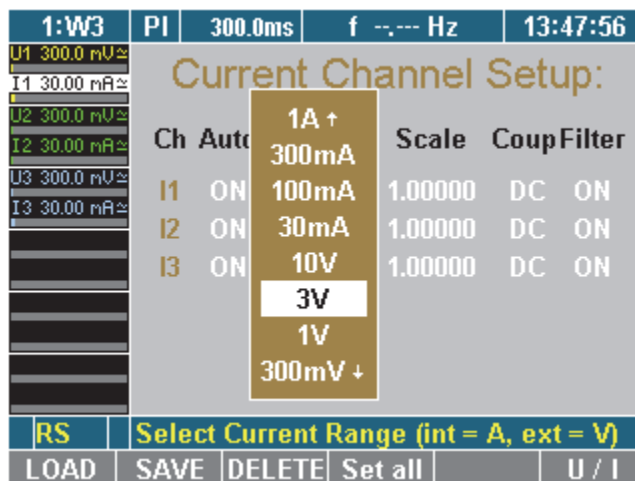

esn026.gif

2. If you wish to configure all three current channels in this way press **Set All**.
3. Save the configuration settings by pressing the **SAVE** function key.
The current input is now changed to the external BNC input.

Configure Auto-Range Selection

First field in column Auto is highlighted.

1. Press **Enter**, select **ON** and confirm with **Enter**.
2. If you wish to configure all three current channels in this way press **Set All**.
3. Save the configuration settings by pressing the **SAVE** function key.

Auto range is now enabled.

Configure Scale

If you intend to use a shunt or a probe, you must adjust the scale for the output of the measuring signal.

Note

The correct parameter settings are shown on the type plate of the shunt or probe.

You can:

- Enter the transducer ratio (U over I) at the external current meters and instruct the device to calculate the final scale factor.
- Or, enter the scale factor at the current transducer so that the final scale factor can be calculated.

The parameters of the formula must be entered as follows:

- Scale factor x transducer ratio, whereby:
 Scale factor: generally "1.0000" (one).
 Transducer ratio: current (in ampere) to voltage (in volt).

Note

If you select Set all to apply the configuration to all channels, only the scale factor is transferred. If shunt values U/I are entered, the scale factor is always 1, and Set all is not available. If probes are used, it is generally easier to enter the transducer ratio, and Set all is thus not recommended.

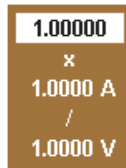

esn024.tif

1. Move the cursor to the value in column Scale and press **Enter**.
A dialog window showing the scale formula is displayed.
2. Select a value for each parameter and press **Enter** to confirm.
The settings are shown in column Scale.
3. Save the configuration settings by pressing the **SAVE** function key.

Integration Function Configuration

This configuration controls key parameters required for the calculation of integrated values over time.

Note

You can select up to six different integration parameter (values) out of a list. Active power P1 to P3 and the sum power are preselected.

Integration Setup

When the Power Analyzer is switched on; the start screen is displayed.

1. Press function key **WAV**.
The integration symbol is displayed in the assignment bar for function keys.

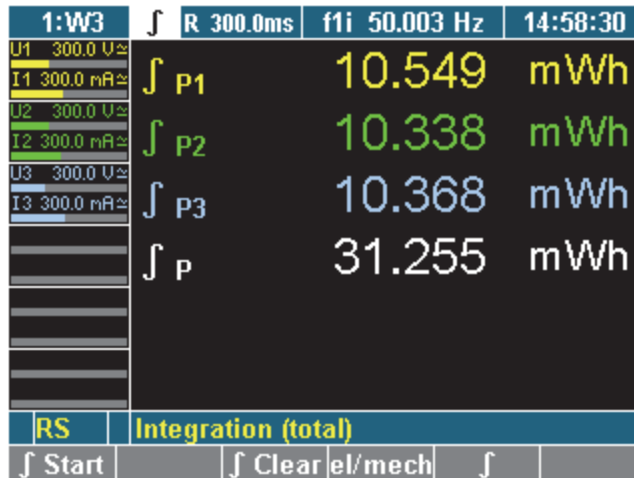

esn027.gif

2. Press the softkey \int .
Integration symbol is displayed in the menu bar.
3. Move Cursor to \int display and press **Enter**.
The Integration Setup menu is displayed.

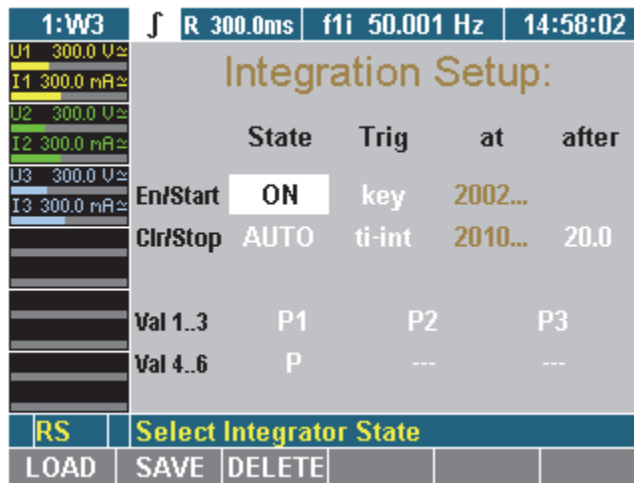

esn028.gif

In the Integration Setup menu, define the following settings:

Line	Function
En/Start	Enable integration function/ set start conditions
Clr/Stop	Configure data reset / set stop conditions
Val 1..3	Select first three values
Val 4..6	Select next three values

Menu Integration Setup is displayed on the screen.

Select Integration Value

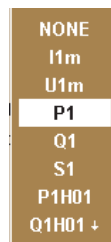

esn029.eps

1. Select with the cursor in line Val 1..3 or Val 4..6 a value and press **Enter**.
A dialog window showing the selectable values is displayed.
2. Move the Cursor in the window to the wanted value and press **Enter** to confirm.
The parameter is now shown on the display.
3. Configure the other values accordingly.
4. Save the configuration settings by pressing the **SAVE** function key.

Configure Status

In this menu you can enable / disable the integration function. Also the way of clearing the values can be configured. This is done in the Integration Setup menu at column State.

Line	Settings	Description
En	ON	Integration function active
	OFF	Integration function inactive
Clr	MAN	Clear manual
	AUTO	Auto clear at start

Menu Integration Setup, first field column *State* is highlighted.

1. Press Enter, select **ON** and confirm with **Enter**.
The integrations function is now enabled. If you want to disable it, select **OFF** and press **Enter** to confirm.
2. Save the configuration settings by pressing the **SAVE** function key.

Note

The integration function is enabled (ON) in the factory configuration 1:W3.

Menu Integration Setup, second field column State is highlighted.

1. Press **Enter**, select **AUTO** and confirm with **Enter**.
Clear values at start is now enabled. If you want to change it, select **MAN** and confirm with **Enter**.
2. Save the configuration settings by pressing the **SAVE** function key.

Note

In the factory configuration 1:W3 the function clear manual (MAN) is preselected.

Configure Start

You can select different start conditions:

Column	Settings	Description
Trig	Remote time key	Start via Interface command Start on date and time Start when key pressed (Key F1)
at	-Date-	Start time(only active at Trig time)
after	-	No function

Menu Integration Setup, first field column Trig is highlighted.

1. Press Enter, select start condition and confirm with Enter.
2. Start condition is now set. If you have selected a time to start (time) enter the time in the column at. Proceed as described below:

Menu Integration Setup, first field column at is highlighted.

1. Press Enter, select year, month, day, hour minute and seconds with the cursors and confirm with Enter.
Start time is now set.
2. Save the configuration settings by pressing the **SAVE** function key..

Note

Date and time for start is taken from the clock in the unit. Correct the date and time of the unit before you start the integration calculation (chapter 7 "Adjust Date and Time").

Configure Stop

You can select different stop conditions:

Column	Settings	Description
Trig	Remote	Stop via Interface command
	time	Stop at date and time
	key	Stop when key pressed (Key F2)
	ti-int	Stop after time window
at	-Date-	Stop on date and time (only active at Trig time)
after	-time-	Integrations time window in sec. (only active at Trig ti-int)

Menu Integration Setup, second field column Trig marker.

- Press **Enter**, select stop condition and confirm with Enter.
- Stop condition is now set. If you have selected a time to start (time) enter the time in the column at. Proceed as described below:

Menu Integration Setup, first field column at is highlighted.

- Press **Enter**, select year, month, day, hour minute and seconds with the cursors and press **Enter** to confirm.
- Stop time is now set. If you have an integration time window selected (ti-int) proceed as follow:

Menu Integration Setup, second field column after is highlighted.

- Press **Enter**, select time with the cursors and confirm with Enter.
Stop time is now set.
- Save the configuration settings by pressing the **SAVE** function key.

Save Configuration

A configuration menu is displayed on the screen.

1. Press function key **SAVE**.

A list showing all existing configurations is displayed.

2. Select a configuration (for example, 10:USER) and press **Enter** to confirm.

The configuration is now being saved with the new name. The name of the new configuration, 10:USER, is displayed in the menu item. W2 configurations are marked as **User2**.

At the next startup of the device, the last saved and loaded configuration is applied by default.

Delete Configuration

A configuration menu is displayed on the screen.

1. Press function key **DELETE**.

A list showing all existing configurations is displayed.

2. Select a configuration (for example, 10:USER) and confirm with **Enter**.

The configuration is now being deleted.

3. Press **Enter** or **Esc** to return to the previous screen.

Undersampling and Aliasing

For signal analysis like DSO (scope) or harmonic analysis (FFT) with digital sampling procedures, you need to consider Shannon's sampling theorem that states: "The sample frequency must be, at minimum, double that of the highest signal frequency." If not considered, it may result in display values (frequencies or waveforms) that do not exist, in other words, aliasing.

If you want to measure numeric time-based mean values like rms, rectified mean, and mean, you do need not observe Shannon's theorem. For the precision of the results, only the number of samples is important, not the sampling frequency (average time \gg cycle duration). The sampling signal must be statistically independent, which means the sampling frequency must not be close to, or a multiple of, the signal frequency.

Note

To operate in the "undersampling mode," the anti-aliasing filter must be turned OFF at the current and voltage channel (see the earlier section "Configure Current and Voltage Channels" in this chapter).

Chapter 8

Measuring Process

Title	Page
Introduction.....	8-3
Prior to Measuring	8-3
Measuring with Default Configuration.....	8-3
Measuring with User-Defined Configuration.....	8-3
Measure Voltage, Current and Power.....	8-4
Measured Values for Individual Channels	8-4
View the Values of One Channel.....	8-4
View Detailed Values of One Channel	8-4
View Totals of all Measured Values	8-7
View Totals	8-7
View Efficiency	8-8
Compare Measured Values.....	8-9
View Fundamental Values	8-11
View Fundamental Value Details.....	8-11
User-Defined Screen View.....	8-13
View User-Defined Screen	8-13
Select Numeric Values.....	8-14
Change User-Defined Display Size.....	8-15
Save User Defined Screen.....	8-15
Back to Common Numeric Screen.....	8-15
Change View Mode	8-15
Numerical Display.....	8-16
Vector Graphs.....	8-16
View Vector Graphs.....	8-16
Adjust Scale	8-16
Oscilloscope Curves	8-17
View Oscilloscope Display	8-17
Adjust Scale of Axes.....	8-18
Adjust Zero	8-18
Recorder View.....	8-18
Harmonic Analysis	8-19
FFT Mode.....	8-21
Adjust Scale	8-21
View Details of a Measured Value	8-22
Set Frequency Range.....	8-22

Set View Mode.....	8-24
Harmonic Order Mode	8-24
View Harmonics.....	8-24
View Harmonics Spectrum Relative to Fundamental in %.....	8-26
STD Harmonic Mode (EN 61000-4-7 Ed 2.1 compliant)	8-28
View Harmonics.....	8-28
Integration Function/Electrical Work	8-31
Save and Print Measurements.....	8-33
Save Measurements	8-33
Print Measurements	8-33
VNC Remote Operation.....	8-33
Introduction	8-33
VNC Device Support.....	8-33

Introduction

The Fluke NORMA 4000/5000 Power Analyzer is designed for the measuring of currents and voltages for up to three different channels. The Power Analyzer calculates rms values, real, apparent and reactive power, and other derived values. The accuracy is not affected by the wave form, frequency, or phase shift. Harmonics may be displayed to a maximum of half the sampling frequency.

Default settings are available for loading quick setups. In addition, you can define more specific settings to save and load as required (see, "Configuration" in Chapter 7). The Power Analyzer begins a measurement as soon as the configuration is set and the device is switched on.

Prior to Measuring

Connect Power Analyzer to the mains (power) socket.

1. Check the measuring connections at the Power Analyzer.
2. Switch on the Power Analyzer.

Measuring with Default Configuration

If the default configuration is acceptable, no additional steps are required.

Ensure that the factory configuration is loaded (see, "Load Configuration" in Chapter 7).

Measuring with User-Defined Configuration

If custom analysis is required, load the respective configuration (see "Configuration" in Chapter 7).

Note

If measurements with an external shunt or probe are required, make sure that there is no signal connected at the direct current inputs. Signals on both inputs (external- and direct-current input) can damage the measurement unit.

Measure Voltage, Current and Power

Measured Values for Individual Channels

Note

The description that follows is for a W3 configuration. The W2 configuration is basically the same with some differences. In W2, some values are invalid and are suppressed. The phase voltage does not exist and is replaced by the phase-to-phase voltage, reactive power, and apparent power and are available as totals only.

View the Values of One Channel

After switching on the Power Analyzer, the display shows the numerical values measured in channel 1.

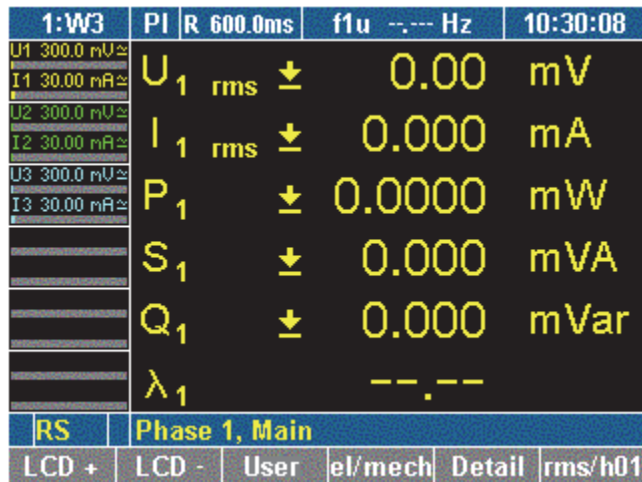

esn030.gif

Display	Description
U _{1 rms}	rms voltage value
I _{1 rms}	rms current value
P ₁	Real power
S ₁	Apparent power
Q ₁	Reactive power
λ ₁	Power factor lambda (capacity or inductance)

Press measuring keys 1 through n to view the values of the respective channels.

View Detailed Values of One Channel

You have the option to view detailed data regarding the measured values of a channel.

1. Press measuring keys **1...n** to view the measured values of the respective channel.
2. Press function key **Detail**.

Details regarding the voltage values for channel 2 are shown in the following example.

1:W3		PI	R 309.9ms	f1u 22.585 Hz	12:28:05
U1 100.0 V \approx					
I1 300.0 mA \approx	U ₂ rm		21.96	V	
U2 100.0 V \approx	U ₂ m		-0.06	V	
I2 300.0 mA \approx	U ₂ cf		3.938		
U3 100.0 V \approx	U ₂ ff		1.4379		
I3 300.0 mA \approx	U ₂ p+		124.3	V	
	U ₂ p-		-88.0	V	
RS	Phase 2, Voltage detail				
LCD +	LCD -	User	el/mech	Detail	rms/h01

esn031.gif

Display	Description
U ₂ rm	Rectified mean value
U ₂ m	Mean value
U ₂ cf	Crest factor
U ₂ ff	Form factor
U ₂ p+	Positive peak value
U ₂ p-	Negative peak value

- Press function key **Detail** again.

Detailed current values are displayed. The equivalent parameters to those shown above for voltage are displayed.

- Press function key **Detail** again.

Detailed power values for channel 2 are shown.

1:W3		PI	R 309.9ms	f1u 22.586 Hz	12:29:10
U1 100.0 V \approx					
I1 300.0 mA \approx	P ₂		1.139	W	
U2 100.0 V \approx	P _{c2}		0.851	W	
I2 300.0 mA \approx	Z ₂		196.03	Ω	
U3 100.0 V \approx	φ ₂		77.15	$^{\circ}$	
I3 300.0 mA \approx					
RS	Phase 2, Power detail				
LCD +	LCD -	User	el/mech	Detail	rms/h01

esn032.gif

Display	Description
P_2	Power
P_{c2}	Corrected power
Z_2	Apparent impedance
φ_2	Angle between U_2 and I_2

5. Press function key **Detail** again.

Detailed phase-to-phase voltages are displayed.



esn033.gif

6. To return to the measured values for channel 2, press function key **Detail** again.

View Totals of all Measured Values

View Totals

1. Press measuring key Σ .

The totals of the measured values of the first three channels are displayed (channel 1-3).

Note

In the W2 configuration, the total values are calculated from the results of channel 1 and channel 2 only. Channel 3 operates independently.

1:W3		PI	R 400.2ms	f1u 14.994 Hz	09:58:41
U1 1.000 kV \approx	I1 10.00 A \approx	U	λ rms	\pm	0.2146 kV
U2 1.000 kV \approx	I2 10.00 A \approx				
U3 1.000 kV \approx	I3 10.00 A \approx				
U4 1.000 kV \approx	I4 10.00 A \approx	I	rms	\pm	3.454 A
U5 1.000 kV \approx	I5 10.00 A \approx				
U6 1.000 kV \approx	I6 10.00 A \approx	P	\pm	1.7691 kW	
U4 1.000 kV \approx	I4 10.00 A \approx	S	\pm	2.226 kVA	
U5 1.000 kV \approx	I5 10.00 A \approx	Q	\pm	1.351 kVar	
U6 1.000 kV \approx	I6 10.00 A \approx	λ	\pm	0.7946 ind	
RS	Totals (1/2/3), λ				
LCD +	LCD -	User	el/mech	λ / Δ	rms/h01

esn034.gif

2. Press measuring key Σ again.

The totals of the measured values of the second three channels are displayed (P channel 4-6).

1:W3		PI	400.3ms	f1u 14.989 Hz	10:03:18
U1 1.000 kV \approx	I1 10.00 A \approx	U'	λ rms	\pm	0.2411 kV
U2 1.000 kV \approx	I2 10.00 A \approx				
U3 1.000 kV \approx	I3 10.00 A \approx				
U4 1.000 kV \approx	I4 10.00 A \approx	I'	rms	\pm	3.926 A
U5 1.000 kV \approx	I5 10.00 A \approx				
U6 1.000 kV \approx	I6 10.00 A \approx	P'	\pm	2.2543 kW	
U4 1.000 kV \approx	I4 10.00 A \approx	S'	\pm	2.841 kVA	
U5 1.000 kV \approx	I5 10.00 A \approx	Q'	\pm	1.729 kVar	
U6 1.000 kV \approx	I6 10.00 A \approx	λ'	\pm	0.7934 ind	
RS	Totals (4/5/6), λ				
LCD +	LCD -	User	el/mech	λ / Δ	rms/h01

esn035.gif

View Efficiency

Press measuring key Σ three times (or again, if continuing from previous view).
The efficiency and the total active power are displayed.

1:W3		PI	R	299.9ms	f1u	50.013 Hz	15:39:13
U1	300.0V \approx	η_e	\pm	43.58	%		
I1	300.0mA \approx						
U2	300.0V \approx	η'_e		77.25	%		
I2	390.0mA \approx						
U3	300.0mV \approx			P	\pm	38.270	W
I3	30.00mA \approx						
				P ₂		21.591	W
RS		Efficiency (user defined)					
LCD +	LCD -	User	el/mech	Config	rms/h01		

esn036.gif

Note

The efficiency screen and totals channels 4-6 screen only appear if there are 4 to 6 power phases equipped.

The variables for electrical efficiency measurement are user selectable. To view the Efficiency Setup screen, press **Config** (F5).

1:W3		PI	R	299.9ms	f1u	50.020 Hz	15:41:17
U1	300.0V \approx	Efficiency Setup: $\eta_e = \text{P1} / P$ $\eta'_e = P1 / P2$					
I1	300.0mA \approx						
U2	300.0V \approx						
I2	390.0mA \approx						
U3	300.0mV \approx						
I3	30.00mA \approx						
RS		+++ Select User-Defined Function					
LOAD	SAVE	DELETE	Default	Config			

esn088.gif

To view the variables, press **Config** (F5) again. Each of the four variables shown are selectable from the list of active power values.

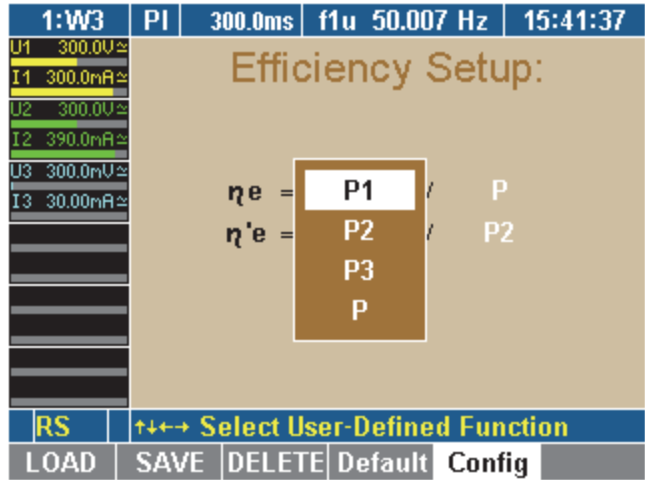

esn089.gif

Compare Measured Values

You have the option to compare the values measured at the different channels, that is, all voltages measured at all channels. Using the WAV function key, the comparative display switches from voltage to current and power, showing the respective values of all three channels.

1. Press measuring key **WAV**.

The measured voltages and phase-to-phase voltages are displayed.

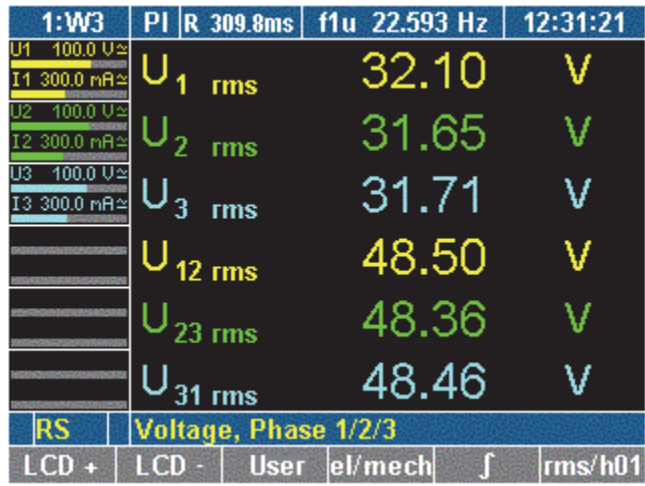

esn037.gif

Display	Description
U ₁ rms ... U ₃ rms	rms voltage at channels 1 to 3
U ₁₂ rms ... U ₃₁ rms	Phase-to-phase voltage at channels 1/2, 2/3 and 3/1

2. Press key **WAV** again.

The measured current values I1 to I3 for the three channels are displayed.

3. Press key **WAV** again.

The power and power factor values are displayed.

The screenshot shows a multi-line display with the following data:

1:W3	PI	309.9ms	f1u	22.585 Hz	12:32:20
U1 100.0 V _{rms}	P ₁	I1 300.0 mA _{rms}	1.164	W	
I1 300.0 mA _{rms}					
U2 100.0 V _{rms}	P ₂	I2 300.0 mA _{rms}	1.127	W	
I2 300.0 mA _{rms}					
U3 100.0 V _{rms}	P ₃	I3 300.0 mA _{rms}	1.134	W	
I3 300.0 mA _{rms}					
	λ ₁		0.2249	ind	
	λ ₂		0.2221	ind	
	λ ₃		0.2219	ind	
RS	Power, Phase 1/2/3				
LCD +	LCD -	User	el/mech	f	rms/h01

esn038.gif

Display	Description
P ₁ ... P ₃	Power at channels 1 to 3
λ ₁ ... λ ₃	Power factors at channels 1 to 3

To select channels 4 to 6, repeatedly press key **WAV**.

View Fundamental Values

For each measured value, the Power Analyzer calculates the fundamental by means of Fourier transformation (DFT).

1. Press measuring keys Σ or 1...n and **WAV** to call up the desired values, for example, power at channels 1 to 3.
2. Press function key **rms/h01**.

The power of the fundamentals is displayed and noted as **H01**.

1:W3	PI	314.0ms	f1u	50.956 Hz	13:11:24
U1 100.0 U \approx	P ₁	H01	1.607	W	
I1 300.0 mA \approx					
U2 300.0 U \approx	P ₂	H01	1.584	W	
I2 300.0 mA \approx					
U3 300.0 U \approx	P ₃	H01	1.597	W	
I3 300.0 mA \approx					
	λ_1	H01	0.3074	ind	
	λ_2	H01	0.3036	ind	
	λ_3	H01	0.3048	ind	
RS	Harmonic power, Phase 1/2/3				
LCD +	LCD -	User	el/mech	f	rms/h01

esn039.gif

3. To return to the power values, press function key **rms/h01** again.

View Fundamental Value Details

You have the option to view detailed data regarding a fundamental, such as voltage, current, power and phase-to-phase voltage.

1. Press measuring keys Σ or 1...n and **WAV** to call up the desired values, for example values measured at channels 3.
2. Press function key **rms/h01**.

Detailed measured values in connection with the fundamentals at channel 3 are shown.

1:W3	PI	314.0ms	f1u	50.956 Hz	13:15:40
U1 100.0 V \approx	U ₃ H01			33.20	V
I1 300.0 mA \approx					
U2 300.0 V \approx	I ₃ H01			156.34	mA
I2 300.0 mA \approx					
U3 300.0 V \approx	P ₃ H01			1.590	W
I3 300.0 mA \approx					
	S ₃ H01			5.19	VA
	Q ₃ H01			4.94	Var
	λ_3 H01			0.3063	ind
RS Phase 3, Harmonic main					
LCD +	LCD -	User	el/mech	Detail	rms/h01

esn040.gif

- Press function key **Detail**.

Details of the voltage of the fundamental of channel 3 are shown.

1:W3	PI	314.0ms	f1u	50.958 Hz	13:15:56
U1 100.0 V \approx	U ₃ H01			33.27	V
I1 300.0 mA \approx					
U2 300.0 V \approx	U ₃ thd			127.60	%
I2 300.0 mA \approx					
U3 300.0 V \approx	U ₃ hc			78.71	%
I3 300.0 mA \approx					
	U ₃ fc			61.68	%
RS Phase 3, Harmonic voltage detail					
LCD +	LCD -	User	el/mech	Detail	rms/h01

esn041.gif

Display	Description
U ₂ H01	rms value of fundamental
U ₂ thd	Total harmonic distortion (according to IEC)
U ₂ hc	Harmonic content (according to DIN)
U ₂ fc	Fundamental content

- Press function key **Detail** twice.

Details of the power of the fundamental at channel 3 are shown.



esn042.gif

Display	Description
P3 H01	Power of fundamental
Z3 H01	Apparent impedance of fundamental
φ3 H01	Angle between U3 and I3 of fundamental

- To return to the display of the fundamentals for channel 3, press function key **Detail** twice.
- To return to the measured values for channel 3, press function key **rms/h01** again.

User-Defined Screen View

In this menu you can configure your own defined numeric screen. You can change this user defined screen to get 3, 6, or even 9 values displayed on one screen.

View User-Defined Screen

- Press function key **User**.
 The display shows the user defined screen.

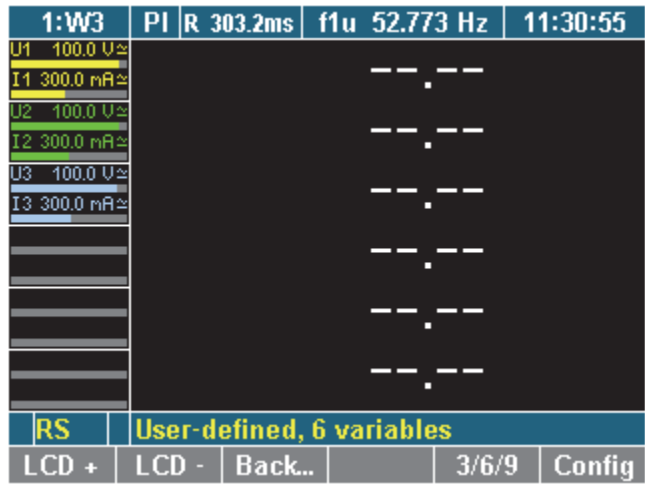

esn043.gif

Note

The first time you view the user-defined screen, it is empty, showing only dashes. In all other cases, the user-defined screen shows the last saved configuration or the recently selected values.

Select Numeric Values

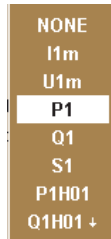

esn029.eps

You can select values out of a list of more than 450 variables, depending on how many channels are installed in the unit.

1. Press function key **Config**.
The configuration menu is shown.
2. Select the row with the cursor and press **Enter**.
A dialog box showing the selectable values is displayed.
3. Select a value with the cursor or use the keys **Σ**, **1...n** or **WAV** to directly jump to the respective blocks of variables (totals, next phase or next function)
4. Press **Enter** to confirm.
The selected value is shown on the display.
5. Repeat steps 2...4 for all required variables.
6. Press **Esc** to leave the *User-Defined Screen* configuration.

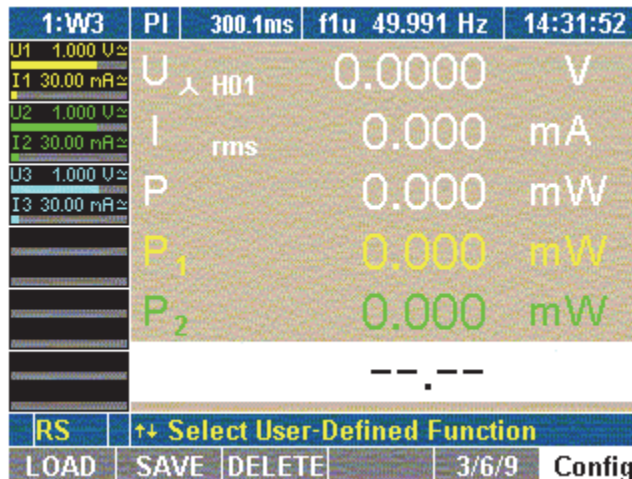

esn044.gif

Note

You can configure and display up to nine variables (values). To change the user defined display size, see the next section.

Change User-Defined Display Size

You can change the size of the numeric display in the user defined screen. You can select between three sizes:

Size	Description
3	three numeric values, double size
6	six numeric values, common size (7 mm)
9	nine numeric values, with size 5 mm

Press function key **3/6/9**.

User defined values are shown in desired size.

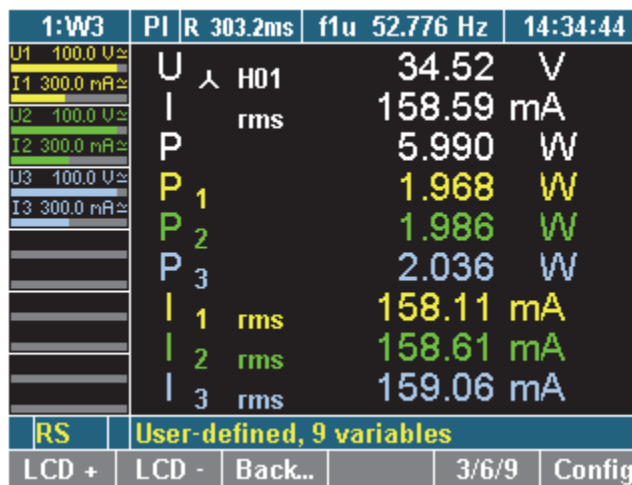

esn045.gif

Note

The changing of the display size is done in a loop, every time you press the function key 3/6/9.

You can change the size in the configuration menu and also in the measurement menu.

Save User Defined Screen

Save the configuration settings by pressing the **SAVE** function key.

See details about saving a configuration in section "Save Configuration" in Chapter 7.

Back to Common Numeric Screen

- Press function keys **Back...** or **Esc**
- The recently used numeric screen is shown.

Change View Mode

After having selected a channel and the relevant measured values, you have the option to change to different view modes where the parameters are shown in the form of numerical values, vector graphs or oscilloscope graphs.

Numerical Display

For details regarding the numerical display of measured values, refer to the section, “Measure Voltage, Current and Power,” in Chapter 8.

Vector Graphs

Up to six signals of the H01 fundamentals can be viewed as vector graphs.

The vector graphs show voltage and current with amplitude and phase shift, and allow for the fast assessment of signals and detection of errors in the connections.

View Vector Graphs

1. Press measuring keys Σ or **1...n** and **WAV** to call up the desired values, that is, values measured at WAV power.
2. Press measuring key **Vector** graphs.

The measured values are shown in the form of vector graphs.

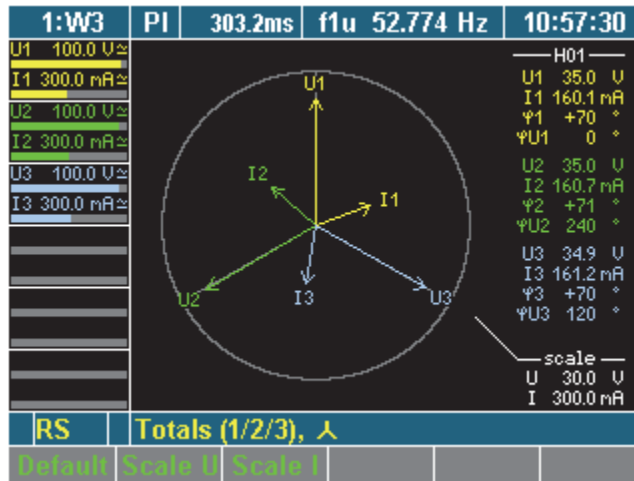

esn046.gif

Display	Description
φ 1 ... φ 3	Phase angle between U and I
φ U1	... reference point (always = 0)
φ U2	Angle between U2 and U1
φ U3	Angle between U3 and U1
scale	Range (reference value for the diameter of the outer circle)

3. To view a different channel or different measured values in vector graph form, press measuring keys Σ or **1...n** and **WAV**.

Adjust Scale

The scale of the vector in the vector diagram is adjustable.

1. To automatically optimize the scale of the graph, press function key **Default**.
The scale is set to the measurement range.

- To change the scale of the axes, press function key **Scale U** or **Scale I**.
- Adjust the scale using the cursor keys up and down, then press **Enter** to confirm or **Esc** to exit.

Oscilloscope Curves

The digital oscilloscope function (DSO) allows for display of signals in curves, so that signal distortions are quickly detected.

View Oscilloscope Display

- Press measuring keys Σ or **1...n** and **WAV** to call up the desired values, for example values measured at channels 1.
- Press measuring key **Oscilloscope** curves.

The measured values are shown in the form of oscilloscope curves.

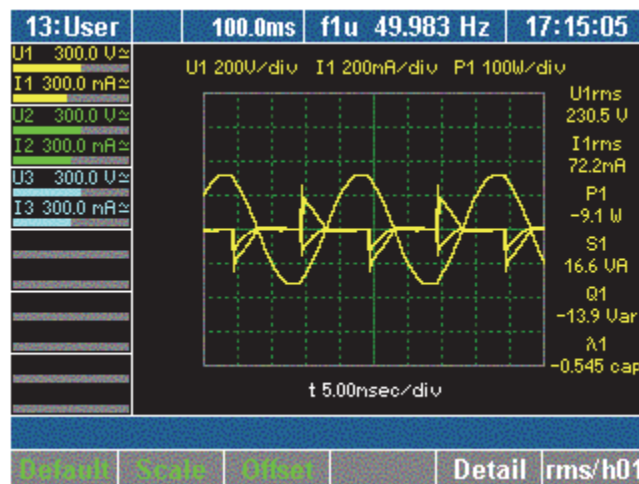

esn047.gif

- To view the details regarding a measured value, press function key **Detail**.
The display shows the measured voltage.

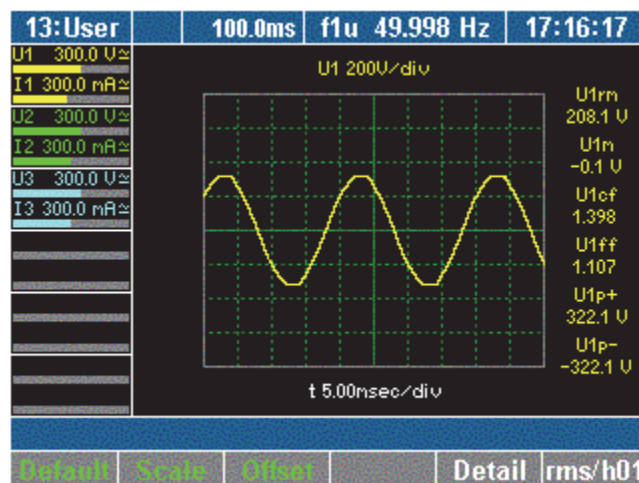

esn048.gif

4. To view a different measure parameter, press function key **Detail** again.
5. To return to an overview of all measured values for channel 1 in oscilloscope format, press function key **Detail** again.
6. To view a different channel or different measured values in oscilloscope graph form, press measuring keys Σ or **1...n** and **WAV**.

Adjust Scale of Axes

The oscilloscope display can be optimized in a number of ways.

1. To automatically scale the graph, press function key **Default**.

The scale is set to steps of 5 ms.

2. To change the scale of the axes, press function key **Scale**.

Adjust the scale, using the cursor keys:

Cursor Key	Function
Left or right	Adjust scale of time axis
Up or down	Adjust scale of amplitude axis
Enter	Confirm settings
Esc	Exit scale mode

3. Adjust the scale of the axes using the cursor keys, and press **Enter** and **Esc**.

The oscilloscope display with the adjusted axes is shown.

Adjust Zero

1. Press function key **Offset**.
2. Adjust the zero point by using the cursor keys and press **Enter** to confirm.

The oscilloscope display with the adjusted zero point is shown.

Recorder View

The recorder allows you to monitor measured values, by recording the mean measured values over time. This function is particularly useful for the detection of trends and amplitude variations. The actual graph depends on the configured range and average time (see the section, “General Setup,” in chapter 7). Prominent variations in the graph indicate errors in the measuring system.

To view the recorder:

1. Press measuring keys Σ or **1...n** and **WAV** to call up the values, for example, current measured at channels 1 to 3.
2. Press measuring key **Recorder**.

The display shows a recording of the measured values.

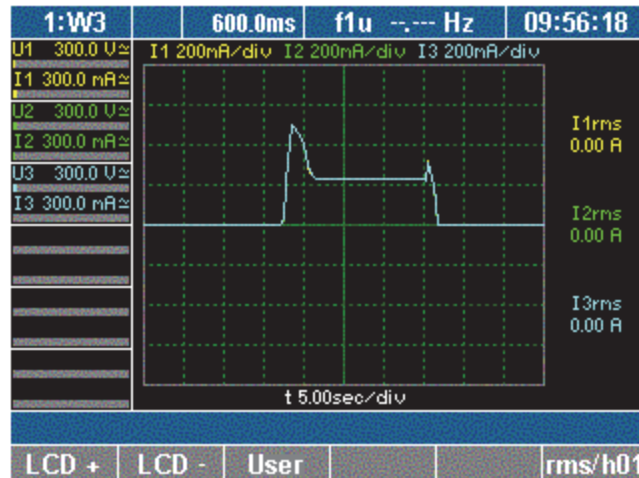

esn049.gif

3. Press the function key **rms/h01** again.

Harmonic Analysis

Harmonic analysis (based on Fast Fourier Transform algorithm) allows for the analysis of the individual frequency components of a signal.

1. Press measuring keys **Σ**, **1...n** or **WAV** to call up the desired values to be analyzed.
2. Press measuring key **Frequency Analysis**.
The frequency analysis is shown in the following screen.

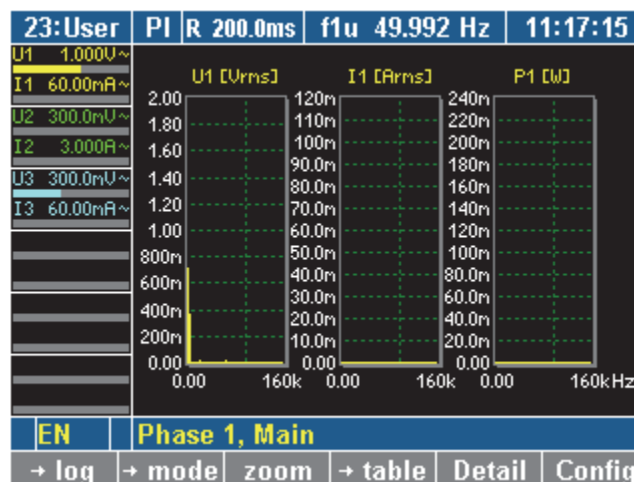

esn102.eps

The following function keys are available:

Function Key	Description
→ lin	Switch to linear Y axis (absolute RMS values)
→ lin % (not for <i>FFT</i> and <i>STD</i> raw mode)	Switch to linear Y axis (relative % to fundamental)
→ log	Switch to logarithmic Y axis (absolute RMS values)
→ log % (not for <i>FFT</i> and <i>STD</i> raw mode)	Switch to logarithmic Y axis (relative % to fundamental)
→ abs	Switch to absolute values in table view
→ % (not for <i>FFT</i> and <i>STD</i> raw mode)	Switch to relative % values in table view
→ mode (<i>FFT</i> and <i>DFT</i>)	Toggle calculation between spectrum and integer harmonics
→ group (<i>STD</i>)	Step through the available grouping modes for <i>STD</i>
zoom	Zoom and shift X axis
→ table	Switch to numeric table view
→ graph	Switch to graphic view
Detail	Switch between U, I and P or overview of one phase
Config	Configure analysis method and parameters

Press **Config** function key to configure the calculation method and parameters:

<i>FFT</i>	Method:	Fixed sampling frequency FFT with Hanning (aka Cosine Bell) windowing
	Parameter:	Select frequency range
	Result:	Harmonic spectrum (absolute RMS values only)
<i>DFT</i>	Method:	Calculation of fundamental and integer harmonics from above FFT by interpolation
	Parameter:	Select frequency range
	Result:	Fundamental frequency and integer harmonics (absolute or relative to H01)
<i>STD</i>	Method:	Synchronized FFT compliant to EN61000-4-7 Ed 2.1 standard (rectangular window)
	Parameters:	Select # of cycles per analysis interval; select grouping method
	Result:	Raw harmonic bins or grouped integer harmonics and / or inter-harmonics
	Requirement:	Valid synchronization frequency

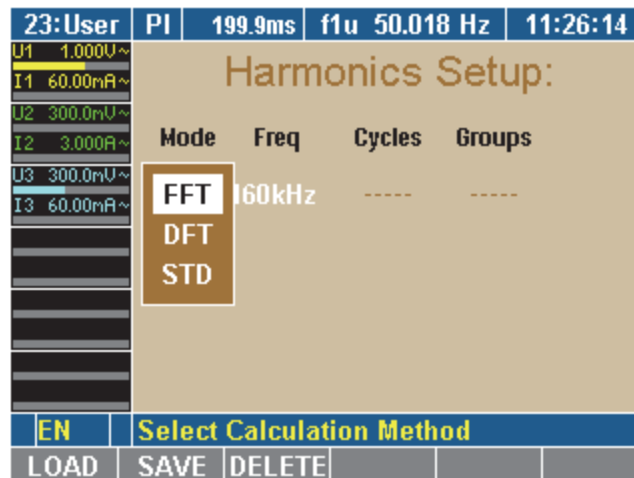

esn103.eps

FFT Mode

Adjust Scale

The option to choose between a linear or logarithmic Y-axis is available by using the **F1** function key, the cursor keys can be used to adjust the frequency axis zoom factor and position.

1. Press function key **F1**. The mode of the Y-axis changes to the mode shown in the respective softkey field (→ **lin** or → **log**).
The scale of the graph changes from linear to logarithmic or vice versa (here: change to logarithmic).

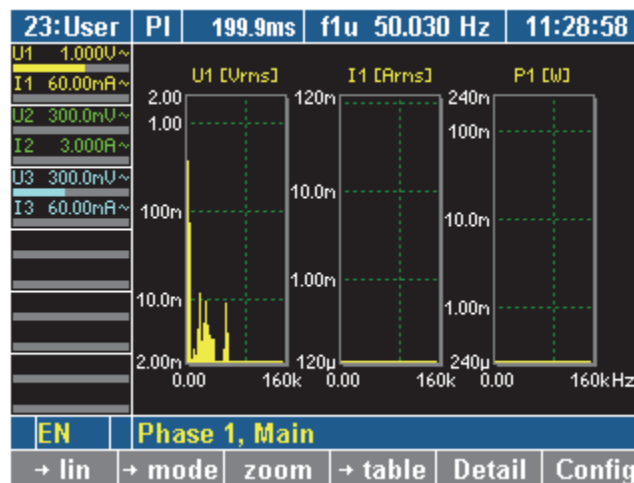

esn104.eps

2. To change the scale of the X-axis, press function key **zoom**.

To adjust the scale, use the cursor keys:

Cursor Key	Function
Left or right	Shift frequency axis
Up or down	Change frequency axis zoom factor
Enter	Confirm settings
Esc	Abort scaling and restore previous setting

- Adjust the scale of the scale of the axis, using the cursor keys, and press **Enter** or **Esc**.
The graph with the adjusted axis is shown.

View Details of a Measured Value

- Press function key **Detail**.
The details of measured value U1 (voltage) are displayed.

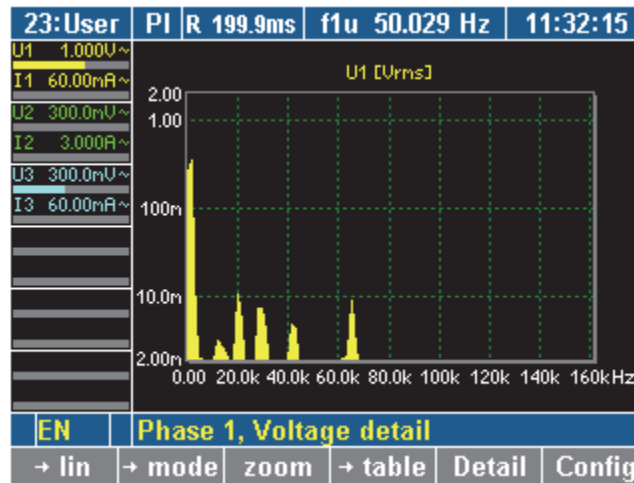

esn105.eps

- Press function key **Detail** again.
The details of measured value I1 (current) are displayed.
- Press function key **Detail** again.
The details of measured value P1 (power) are displayed.
- Press function key **Detail** again.
The details of measured value U12 (phase-to-phase voltage) are displayed.
- To return to the overview of measured values of the selected channel, press function key **Detail** again (or **Esc** from any of the previous detail screens).

Set Frequency Range

The default frequency range is set to a maximum of half the sampling frequency.

Note

For signals with a lower frequency (for example, 10 Hz), the frequency range must be adjusted; otherwise, the measurements would be inaccurate.

1. Press function key **Config**.
The setup screen for harmonics configuration is displayed.
2. If the mode is not set to *FFT*, press **Enter**, select *FFT* and press **Enter** again.
3. Move the cursor to the column *Freq* and press **Enter**.
The popup list shows the available frequency ranges.

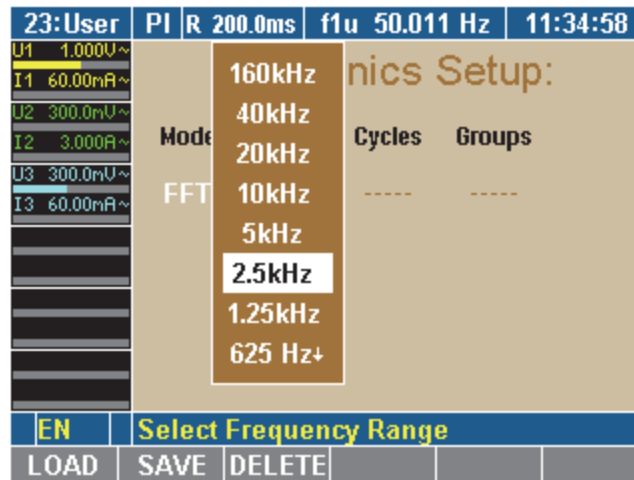

esn106.eps

4. Select a value, using the cursor keys, and press **Enter**.
5. Press **Esc** to return to the measurement screen.
The frequency analysis is carried out up to the selected value, and the result is displayed.

Set View Mode

You have the option to view individual measured values or a group of up to three values (that is, all measured values of a channel) in graphic or table format. By default, the measured values are shown in graphic format.

1. Press function key → **table**.
The data is now shown in a table in numerical format (shown here, current on channel 1).

23:User		PI	R 199.9ms	f1u 50.022 Hz	12:07:16
U1	100.0V~			FFT Freq	I1 [Arms]
I1	3.000A~			0.000 Hz	0.001
U2	300.0mV~			10.42 Hz	0.006
I2	3.000A~			20.83 Hz	0.030
U3	300.0mV~			31.25 Hz	0.418
I3	60.00mA~			41.67 Hz	0.754
				52.08 Hz	0.787
				62.50 Hz	0.668
				72.92 Hz	0.229
				83.33 Hz	0.015
				93.75 Hz	0.004
				104.2 Hz	0.002
EN		Phase 1, Current detail			
		→ mode	scroll	→ graph	Detail Config

esn107.eps

Harmonic Order Mode

View Harmonics

1. Press function key **mode** to switch directly to mode *DFT* and call up a table showing the integer harmonics.

Note

Switching between FFT and DFT is even possible in HOLD mode and therefore allows different views on the data from the same single interval.

2. Alternatively, use function key **Config** to select mode *DFT* in the harmonics setup screen. Afterwards, press **Esc** to return to the measurement screen.

Note

Modes FFT and DFT share the same frequency range setting.

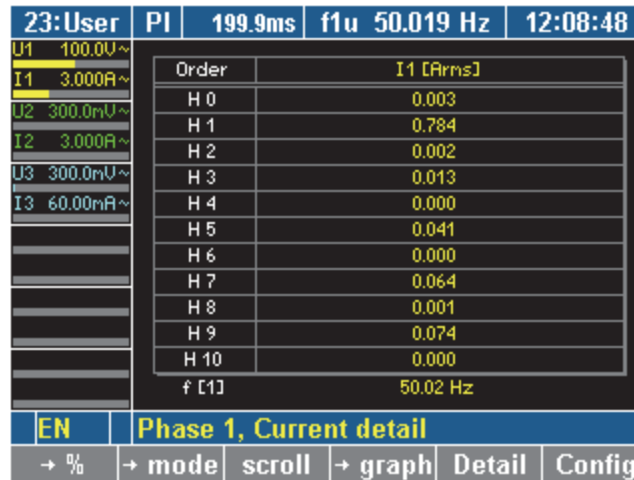

esn108.eps

The following table shows the integer harmonics (in this case, current of the individual harmonics of channel 1).

Display	Description
Order H 0	DC content
Order H 1	Fundamental
Order H 2	2 x fundamental frequency
Order H 3	3 x fundamental frequency
Order ...	n x fundamental frequency
f[1]	Fundamental frequency

3. Press function key **scroll** to enable scrolling and paging through the table.

4. To scroll through the page, use the cursor keys:

Cursor Key	Function
Left or right	Page up and down through table (screen by screen)
Up or down	Scroll up and down through table (line by line)
Enter	Confirm view and exit scale mode
Esc	Abort scrolling and restore previous view

5. At the desired table section, press **Enter** to keep this view or press **Esc** to cancel the scrolling.
The selected table section is now displayed.
6. To change to a graphic display of the harmonics again, press function key → **graph**.

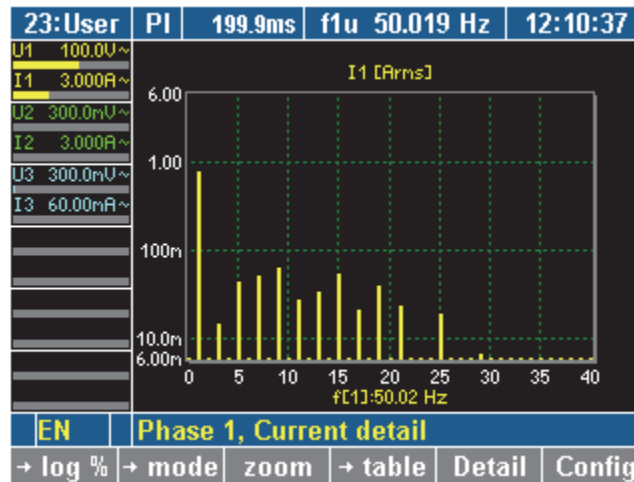

esn109.eps

View Harmonics Spectrum Relative to Fundamental in %

The harmonics spectrum can be viewed in percentages of fundamental H01.

Note

This view is important for the analysis of the input signal.

1. Press function key F1 to step through the available Y-axis modes:

- lin linear axis, absolute values (RMS)
- lin % linear axis, relative values (% of H01)
- log logarithmic axis, absolute values (RMS)
- log % logarithmic axis, relative values (% of H01)
- ...

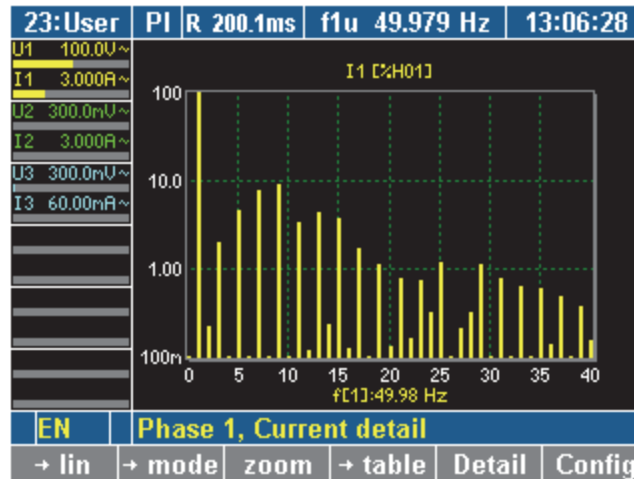

esn110.eps

2. To change to table view of the spectrum, press function key → **table**.

Order	U1 [%H01]	I1 [%H01]	P1 [%H01]
H 0	0.23	0.27	0.00
H 1	100.00	100.00	100.00
H 2	0.25	0.24	0.00
H 3	2.80	1.93	0.05
H 4	0.07	0.08	0.00
H 5	5.21	5.34	0.28
H 6	0.03	0.06	0.00
H 7	7.47	7.54	0.55
H 8	0.05	0.10	0.00
H 9	8.96	9.42	0.80
H 10	0.05	0.06	0.00
f [1]	49.98 Hz	49.98 Hz	49.98 Hz

esn111.eps

3. In table view, press function key **F1** to step through the available view modes:

- % relative view, values are shown in % of H01
- **abs** absolute view, values are shown in RMS
- ...

STD Harmonic Mode (EN 61000-4-7 Ed 2.1 compliant)

View Harmonics

1. Use function key **Config** to open harmonics setup screen. Press **Enter** and select *STD* mode with the cursor keys. Press **Enter** to confirm.
2. Select number of cycles (N) per analysis interval (200ms @ nominal frequency). Only settings of 10 (for 50 Hz) and 12 (for 60 Hz) are defined by the EN standard, the other values (4, 6, 8) are provided for convenience to have a faster update rate when analyzing lower frequency signals.
Analysis interval length = N / f_{sync} [sec]

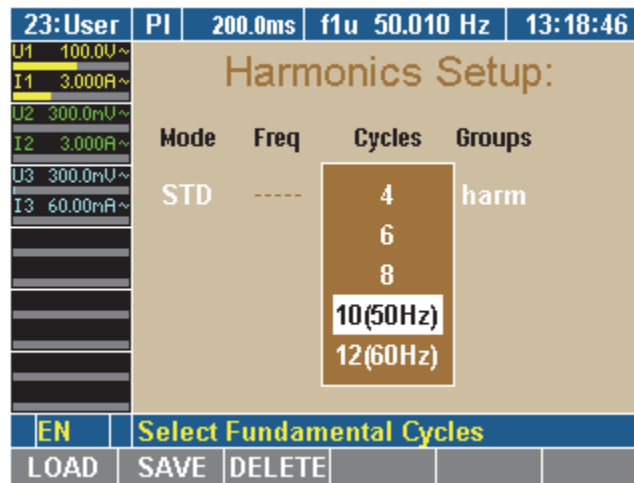

esn112.eps

3. Select grouping mode according to EN standard:

none	No grouping, basic spectral components (absolute RMS only, no THD)
harm	Harmonic components $Y_{H,h}$ (absolute or relative % of H01), THD
hgrp	Harmonic groups $Y_{g,h}$ (absolute or relative % of H01), THDG
hsgrp	Harmonic subgroups $Y_{sg,h}$ (absolute or relative % of H01), THDS
isgrp	Inter-harmonic subgroups $Y_{isg,h}$ (absolute or relative % of H01), TIDS
sgrp	Harmonic & inter-harmonic subgroups $Y_{sg,h} + Y_{isg,h}$ (abs. or rel. % of H01), THDT

Note

THDs are calculated from harmonics or groups 2...40 according to selected grouping mode, shown only in table view (relative % of H01) (TIDS and THDT are not defined in EN standard).

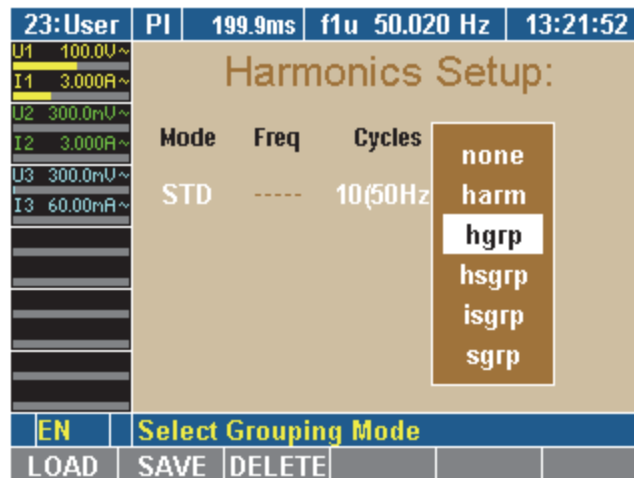

esn113.eps

4. Press **Esc** to return to measurement screen.

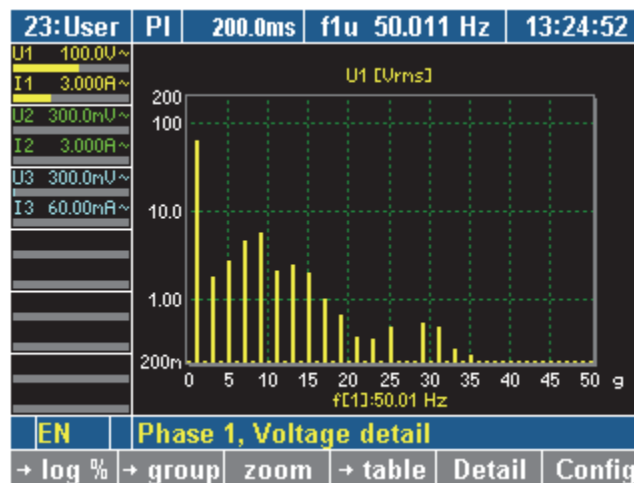

esn114.eps

5. From within the measurement screen, use function key **F1** to step through the Y-axis scaling modes (graph) or numerical format modes (table).
6. Use function key **→ group** to directly step through the grouping modes. The X-axis legend changes accordingly:

<i>kHz</i>	No grouping, spectral components
<i>H</i>	Harmonic components
<i>g</i>	Harmonic groups
<i>sg</i>	Harmonic subgroups
<i>isg</i>	Inter-harmonic subgroups
<i>*sg</i>	Harmonic and inter-harmonic subgroups
<i>kHz ...</i>	

Note

The grouping mode may be changed even in HOLD mode and therefore allows different views on the data from the same single interval.

- To change the scale of the X-axis, press function key **zoom**.

To adjust the scale, use the cursor keys:

Cursor Key	Function
Left or right	Shift frequency / harmonics axis
Up or down	Change frequency / harmonics axis zoom factor
Enter	Confirm settings
Esc	Abort scaling and restore previous setting

- Use function key → **table** to switch to numerical table view and see THD values on the bottom of the screen.

23:User		PI	R 200.1ms	f1u 49.972 Hz	13:33:47
U1	100.0U~	Order		U1 [Urms]	
I1	3.000A~	g 0		0.0	
U2	300.0mU~	g 1		63.5	
I2	3.000A~	g 2		0.0	
U3	300.0mU~	g 3		1.7	
I3	60.00mA~	g 4		0.0	
		g 5		2.9	
		g 6		0.1	
		g 7		4.7	
		g 8		0.1	
		g 9		5.6	
		g 10		0.1	
		f [1]		49.97 Hz	
		THDG [2..40]		14.09 %	
EN	Phase 1, Voltage detail				
→ %	→ group	scroll	→ graph	Detail	Config

esn115.eps

Integration Function/Electrical Work

For the calculation of integrated values the values are measured over time. You can configure up to six independent values (Um, Im, S, P, or Q) for the calculation.

1. Press measuring key **WAV**.

A key for the calculation of the electrical work is shown in the assignment bar for function keys.

1:W3	PI	309.9ms	f1u 22.585 Hz	12:32:20
U1 100.0 V \approx	P ₁	1.164	W	
I1 300.0 mA \approx				
U2 100.0 V \approx				
I2 300.0 mA \approx	P ₂	1.127	W	
U3 100.0 V \approx	P ₃	1.134	W	
I3 300.0 mA \approx				
	λ_1	0.2249	ind	
	λ_2	0.2221	ind	
	λ_3	0.2219	ind	
RS	Power, Phase 1/2/3			
LCD +	LCD -	User	el/mech	∫ rms/h01

esn059.gif

2. Press function key \int .

The assignment bar shows the functions used for the calculation.

1:W3	\int	\int 300.0ms	f1u 50.002 Hz	10:28:38
U1 100.0 V \approx	\int P	541.50	mWh	
I1 300.0 mA \approx				
U2 300.0 V \approx				
I2 300.0 mA \approx	\int Q	2.3403	Vrh	
U3 300.0 V \approx	\int S	2.4021	VAh	
I3 300.0 mA \approx				
	\int I1 m	-181.09	μ Ah	
	\int I2 m	2.8190	μ Ah	
	\int U3 m	-1.8149	mVh	
RS	Integration (total)			
\int Start	\int Stop	\int Clear	el/mech	\int

esn060.gif

Function Key	Function
∫ Start	Start measurement (integration)
∫ Stop	Stop measurement (integration)
∫ Clear	Reset measurement (integration) to zero
∫	Change to display of measured values

3. Press function key **∫ Start** to start the measuring process.
4. Press function key **∫ Stop** to stop the measuring process.

The reference power totals are shown in the following screen.

1:W3	∫	∫ 300.0ms	f1u 50.002 Hz	10:29:08
U1 100.0 V \approx	∫+ P	587.60	mWh	
I1 300.0 mA \approx				
U2 300.0 V \approx				
I2 300.0 mA \approx	∫+ Q	2.5449	Vrh	
U3 300.0 V \approx				
I3 300.0 mA \approx				
	∫+ S	2.6119	VAh	
	∫+ I1 m	0.0000	Ah	
	∫+ I2 m	17.890	μ Ah	
	∫+ U3 m	137.85	μ Vh	
RS	Integration (pos only)			
∫ Start	∫ Stop	∫ Clear	el/mech	∫

esn061.gif

5. Press function key **∫**.

The totals of the output power are shown.

1:W3	∫	∫ 300.0ms	f1u 50.001 Hz	10:29:23
U1 100.0 V \approx	∫- P	0.0000	Wh	
I1 300.0 mA \approx				
U2 300.0 V \approx				
I2 300.0 mA \approx	∫- Q	0.0000	Vrh	
U3 300.0 V \approx				
I3 300.0 mA \approx				
	∫- S	0.0000	VAh	
	∫- I1 m	-203.36	μ Ah	
	∫- I2 m	-15.117	μ Ah	
	∫- U3 m	-2.4296	mVh	
RS	Integration (neg only)			
∫ Start	∫ Stop	∫ Clear	el/mech	∫

esn062.gif

6. To return to the overview of measured values for the selected channel, press function key **∫** again.

Save and Print Measurements

Save Measurements

You have the option to save the sampling values or measurements for later offline analyses, for example, FFT, average startup currents, or transient processes.

Note

Measuring key Storage works only in conjunction with NORMA View software.

For more details, refer to the user manuals of the respective software product.

Print Measurements

- Connect a printer, unless using a NORMA 5000 with optional front-panel printer installed.
- Ensure that the interface is properly configured (see "Configure Data Transfer to Printer and PC" in Chapter 7).
- Press measuring key **Print**.

The measured values are printed.

VNC Remote Operation

Introduction

VNC® (Virtual Network Computing) is a system that allows a user to remotely control a device by displaying its screen on a computer and sending keyboard and mouse events from the computer to the device. VNC uses the RFB® (Remote Frame Buffer) protocol to communicate with the device. A VNC server is running on the device, a VNC client application on the computer can connect to this server for remote device operation. Because they may support different sets of options, both server and client negotiate on connect which common protocol options to use (encryption, compression, color scheme ...). VNC client applications are widely available for computers, tablets and smartphones, most of them for free or for only little cost. Under the most popular ones are *RealVNC*, *TightVNC* and *UltraVNC*.

More information on VNC and RFB can be found here:
http://en.wikipedia.org/wiki/Virtual_Network_Computing

Note

VNC and RFB are registered trademarks of RealVNC Ltd.

VNC Device Support













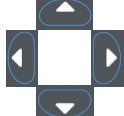

The VNC server in the device is a thin application, running in the background of the important high priority measurement calculation and display tasks. Therefore it only supports some basic features of VNC:

Protocol version:	3.3
Security/Encryption:	none
Device name:	NORMA Power Analyzer
Screen size:	320 x 240

- Color scheme / pixel format: True color (8-, 16- or 32- bit width) or Palette based color (16 colors)
- Pixel encodings: Raw, RRE and CopyRect
- Cursor encoding: Support for custom local mouse cursor
- Key events: see table below for details
- Mouse events: see table below for details

VNC connectivity is only supported on LAN interface (select VNC as protocol) and exclusively (only a single client connection is accepted, no standard Remote Control Command support while in VNC mode).

The following keys are accepted by the device:

Computer Key	Device Front Panel Key	Function
F1 ... F6		As indicated on soft-key bar
Return / Enter		Select
ESC		Abort / return
← → ↑ ↓		Cursor movement
PgUp	-	Previous page (in list boxes only)
PgDn	-	Next page (in list boxes only)
Home	-	First item (in list boxes only)
End	-	Last item (in list boxes only)
+		Phase select
W, w		Function select
S, s		Totals
N, n		Numeric screen
R, r		Recorder screen
O, o		Oscilloscope screen
F, f		Harmonics screen
V, v		Vector screen
H, h		Hold / Run
M, m		Memory trigger
P, p		Print

The following mouse events are accepted by the device:

Mouse Event	Device Front Panel Key	Function
Mouse Move	-	Cursor type change (on hot spots) ¹ 
Left Button Click	Cursors + Enter Esc	Select (on hot spots) Abort (outside of list boxes)
Right Button Click	Esc	Abort / return
Scroll wheel up	Cursor up	Previous item (in list boxes only)
Scroll wheel down	Cursor down	Next item (in list boxes only)
¹ Only if local cursor tracking is supported and enabled in VNC client.		

The following items are “hot” (change mouse cursor) and can be selected by left mouse button click:

- All setup fields in left and top tool bars
- All active soft-key fields in bottom tool bar
- All selectable fields in setup screens
- Items in popup list boxes
- Buttons on the calculator for numeric input
- Measurement screen area to bring up menu for view type select (numeric, oscilloscope ...)

Chapter 9

NORMA Process Interface (Optional)

	Title	Page
Process Interface		9-3
Pin Assignment		9-3
Measured Values		9-4
Torque		9-4
Rotational Speed		9-4
Sense of Direction		9-4
Configuring the Process Interface		9-4
Call Up Motor/Generator Setup		9-4
Select Motor		9-5
Configure Torque Sensor		9-6
Configure Speed Sensor		9-6
Configure Motor or Generator		9-6
Configure Other Motors		9-7
Configure Analog Output		9-7
Measuring with the Process Interface		9-8
View Measured Electric Values		9-8
View Mechanical Values		9-9
View Raw Values		9-10
View Torque – All Motors		9-10
View Speed – All Motors		9-11
Process Interface - Technical Data		9-12
Eight Inputs (Analog/Digital)		9-12
Input Configured as Analog Input		9-12
Input Configured as Digital Input		9-12
Four Digital Inputs for the Detection of the Sense of Rotation		9-12
Four Outputs (Analog)		9-12

Process Interface

The Process Interface allows simultaneous analysis of the electrical and mechanical power of up to four motors (generators). The torque and rotational speed are measured via frequency inputs or as analog signals.

Pin Assignment

Figure 9-1 shows the Process Interface that is located on the rear panel of the Power Analyzer (see "Design and Functions" in Chapter 3).

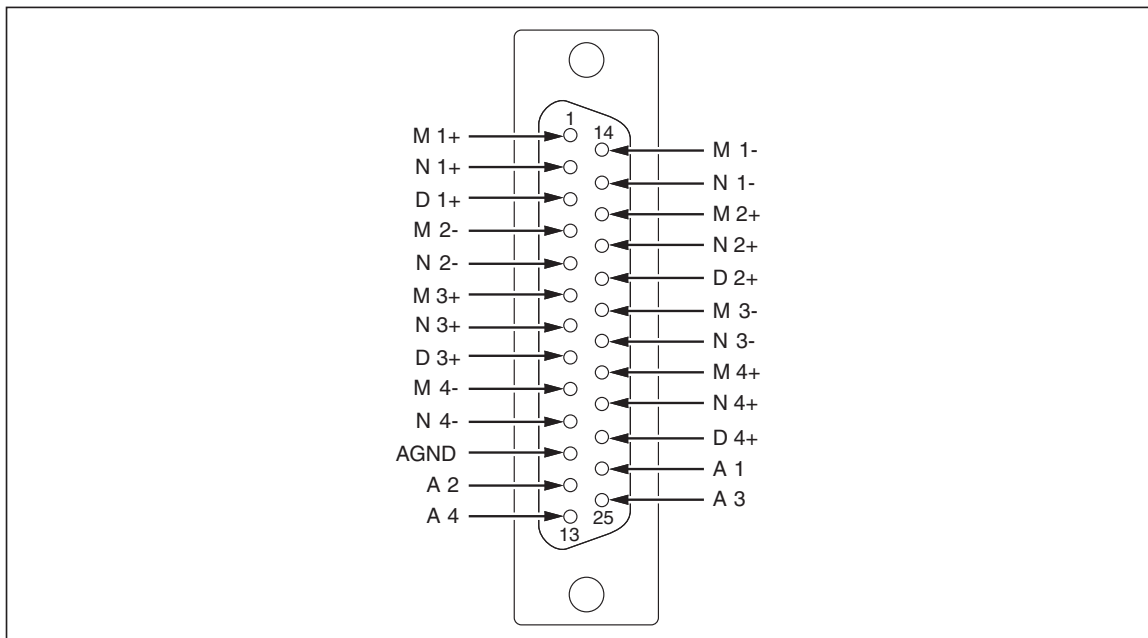

Figure 9-1. Process Interface Pin Assignment

esn063.eps

Pin	Assignment
M1+...M4+ M1-...M4-	Four inputs for torque; configurable for analog or digital signals
N1+...N4+ N1-...N4-	Four inputs for rotational speed; configurable for analog or digital signals
D1+...D4+	Four inputs for sensing rotation; only for motor analysis with digital speed inputs; corresponding inputs, that is N1/D1 share a LO port
AGND	Analog ground input
A1...A4	Four analog outputs

Measured Values

Torque

The torque is measured by means of a force transducer or torque measuring shaft with a ± 10 V dc output or a frequency output.

Rotational Speed

The speed is measured by means of an incremental encoder with TTL or AC output; alternatively, for example, an analog signal from a speedometer can be used.

Sense of Direction

The sense of direction is detected by means of a permanent signal (L = sense of direction positive, H = sense of direction negative); alternatively, it can be determined using an incremental encoder.

In this case, the following applies: if the signal is leading, the sense of direction is positive; if the signal is lagging, the sense of direction is negative.

Configuring the Process Interface

Prior to starting the measuring process, the torque sensor and the speed sensor must be configured. To configure the Process Interface, select menu Motor/Generator Setup. The configuration procedure consists of the following steps:

- Call up Motor/Generator Setup
- Select motor
- Configure torque sensor
- Configure speed sensor
- Configure other motors
- Configure analog outputs

Call Up Motor/Generator Setup

- The device must be equipped with an analog interface process interface
- Menu item PI must be shown in the menu bar

If the Power Analyzer is equipped with a process interface, menu item PI is shown automatically in the menu.

1. Move the cursor to menu item PI and press **Enter**.

Menu Motor / Generator Setup is displayed, showing the settings for motor 1 (M1) as shown below.

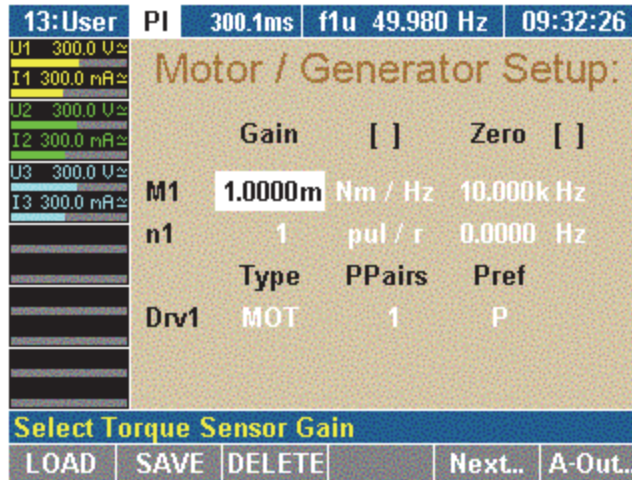

esn064.gif

Adjust the settings as follows:

Line	Description
M1	Configure torque measurement (input, slope and zero) for each motor
n1	Configure speed measurement (speed sensor)
Drv1	Set type (Type), pole pairs (PPairs) and reference power (Pref)

2. If a configuration that suits the measuring layout is already saved, press function key **LOAD**, select the configuration.
3. Press **Enter** to confirm.
4. Adjust configuration as described in the section that follows.

Select Motor

- To configure the system for motor 1, go to the “Configure Torque Sensor” section.
- To configure another motor, press **Next ...** until the respective motor code (M2, M3 or M4) is displayed.

Configure Torque Sensor

The torque can be measured by means of force transducers or a torque-measuring shaft. The signal is transferred via a ± 10 V AC output or a frequency output. In line M, (for example, motor 1: M1), adjust the following settings:

Column	Settings	Description
Gain	1...	Slope
Unit	Nm/Hz Nm/V	Depending on force transducer or sensing shaft type
Zero	1...	Voltage or frequency corresponding to speed = 0
Unit	Hz, V	Unit for zero, depending on sensor type

1. Move the cursor to a field in line M1 and press **Enter**.
A list of possible options is displayed.
2. Select a value and press **Enter** to confirm.
The value is now shown in the display field.

Configure Speed Sensor

Possible speed sensors include the incremental encoder (measuring with TTL / AC output) or an analog signal. In line n (for example, motor 1: n1), adjust the settings:

Column	Settings	Description
Gain	1...	Slope
Unit	pul/r rpm/V	Pulses per revolution Revolutions per volt
Zero	1...	Voltage or frequency corresponding to speed = 0
Unit	Hz, V	Unit for zero, depending on sensor type

1. Move the cursor to a field in line n1 and press **Enter**.
A list of possible options is displayed.
2. Select a value and press **Enter** to confirm.
The value is now shown in the display field.

Configure Motor or Generator

The Power Analyzer can be used for the analysis of both motors and generators. To configure the device, adjust the settings in line Drv1 for motor 1:

Column	Settings	Description
Type	MOT GEN	Motor Generator
PPairs	1 ... 999	Number of pole pairs
Pref	P ... P3	Reference power for efficiency calculation

1. Move the cursor to the field in line Drv1 and press **Enter**.
 A list of possible options is displayed.
2. Select a value and press **Enter** to confirm.
 The value is now shown in the display field.
3. Press function key SAVE to save this configuration.

Configure Other Motors

1. Press the **Next...** function key.
 The settings for motor 2 are displayed.
2. Adjust settings for motors 2 to 4, following the above instructions for motor 1.
3. Press **SAVE** to save the configurations for the motors.

Configure Analog Output

The 4 analog outputs (A1...A4) can be used to output the values measured, calculated, or averaged, or to transfer them to an external device for further processing. By default, the analog outputs are configured as voltage output for ± 10 V. In order to output higher voltages, you must enter the relevant transducer ratio, for example, 10 mV/V for a measured voltage of 220 V and an output of 2.2 V.

1. Press function key **A-Out**.
 The Analog Output Setup menu is displayed.

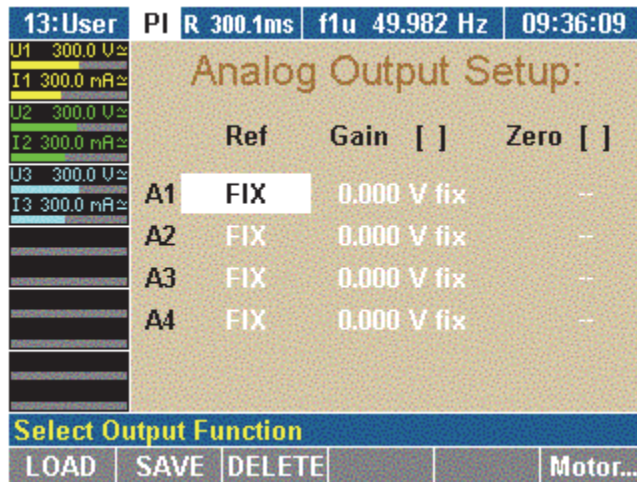

esn065.gif

Adjust the settings:

Column	Settings	Description
Ref	FIX U1, M1, P _{M1} ...	Fixed DC voltage, or selection from available average measured values
Gain	1...	Transducer ratio or fixed value (-10.3 V to +10.3 V)
Unit	V/A, V/V, V/Ohm, V/Hz (depending if Ref is not selected)	that is 10 mV/V, for example, 10 mV at the output corresponds to 1 V of the measured value
Zero	1...	Set zero/offset
Unit	A, W, V, Hz, Ohm	Unit for zero, depending on selected Ref

2. Move the cursor to a field in line A1 and press **Enter**.
A list of possible options is displayed.
3. Select a value and press **Enter** to confirm.
The value is now shown in the display field.
4. Configure analog outputs A2 to A4 accordingly.

Measuring with the Process Interface

Torque, rotational speed and mechanical power are measured in real-time and averaged. They are combined with the measured electrical values so that slip and mechanical efficiency can be calculated.

- The device must be equipped with an Analog Interface.
- Menu item PI must be visible in the menu bar.

If the Power Analyzer is equipped with a process interface, menu item PI is shown automatically in the menu.

View Measured Electric Values

1. Press the **000** measuring key (numerical display).
The measured values of channel 1 are shown.



esn066.gif

Display	Description
U _{1 rms}	rms voltage value
I _{1 rms}	rms current value
P ₁	Real power
S ₁	Apparent power
Q ₁	Reactive power
λ_1	Power factor

2. Press measuring keys **1...n** to view the values of the respective channels.
3. Press function key **el/mech**.

View Mechanical Values

The measured values of motor 1 are shown in the following screen.

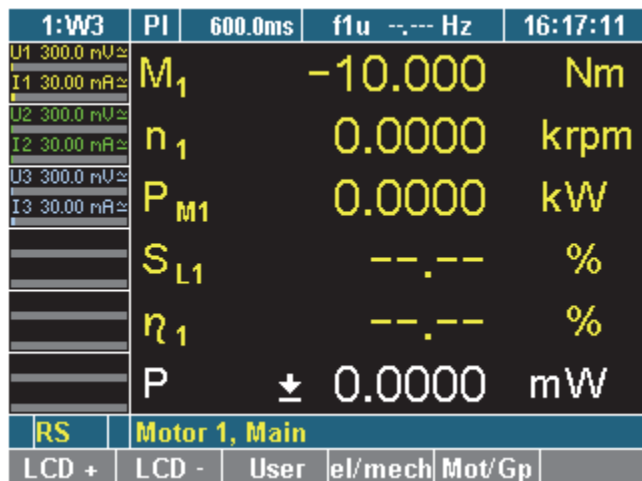

esn067.gif

Press measuring keys **1...n** to view the values of the respective inputs.

Display	Description
M ₁	Motor 1 torque
n ₁	Motor 1 speed
P _{M1}	Motor 1 mechanical power
S _{L1}	Motor 1 slip
η ₁	Motor 1 efficiency
P	Electrical reference power, depending on configuration

View Raw Values

Raw values are unscaled values measured in a channel.

1. Press function key **Mot/Gp**.

The measured value of motor 1 is shown, as in the following screen.

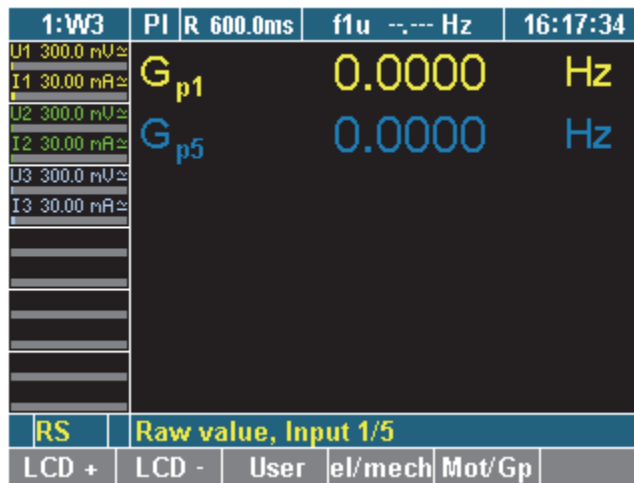

esn068.gif

2. Press measuring keys **1...n** to view the values of the respective inputs.

Display	Description
Gp1	Motor 1 torque
Gp2 ...	Motor 2 torque
Gp5	Motor 1 speed
Gp6 ...	Motor 2 speed

View Torque – All Motors

1. Press measuring key **WAV**.

The torque values for motors 1 to 4 are shown.

1:W3	PI	600.0ms	f1u --- Hz	16:19:13		
U1 300.0 mV \approx	M ₁	-	0.0050	Nm		
I1 30.00 mA \approx			-	10.000	Nm	
U2 300.0 mV \approx				-	0.0000	Nm
I2 30.00 mA \approx					-	20.000
U3 300.0 mV \approx						
I3 30.00 mA \approx						
RS	Torque, Motor 1/2/3/4					
LCD +	LCD -	User	el/mech	Mot/Gp		

esn069.gif

2. Press key WAV again.

View Speed – All Motors

The rotational speeds of motors 1 to 4 are shown in the screen that follows.

1:W3	PI	R 600.0ms	f1u --- Hz	16:21:07		
U1 300.0 mV \approx	n ₁	-	0.0000	krpm		
I1 30.00 mA \approx			-	0.6000	krpm	
U2 300.0 mV \approx				-	0.0000	krpm
I2 30.00 mA \approx					-	120.00
U3 300.0 mV \approx						
I3 30.00 mA \approx						
RS	Speed, Motor 1/2/3/4					
LCD +	LCD -	User	el/mech	Mot/Gp		

esn070.gif

Process Interface - Technical Data

Eight Inputs (Analog/Digital)

Each differential input can be configured individually as an analog or a digital input.

Input Configured as Analog Input

Parameter	Voltage
Range	±10 V nominal (saturation region approx. +2 %)
Maximum input voltage	±50 Vrms
Maximum common mode voltage to ground	±10 V (without additional error)
	±25 V (without limitation by protective components)
Uncertainty of measurement	±(0.1 % of AVG+ 0.08 % of AVGR)

Input Configured as Digital Input

Parameter	Frequency
Measuring signal	TTL-compatible or AC (switching threshold approx. +1.5 V ±0.5 V hysteresis)
Range	0.5 Hz to 500 kHz ^[1]
Maximum input voltage	±50 Vrms
Maximum common mode voltage to ground	±25 V
Uncertainty of measurement	±0.025 % of AVG
<p>[1] The number of pulses per revolution must be synchronized with the rotational speed of the motor in such a way that the maximum measuring frequency is not exceeded. On the other hand, ensure that the resolution is sufficient to measure the frequency at low motor speeds.</p>	

Four Digital Inputs for the Detection of the Sense of Rotation

Inputs for the detection of the sense of rotation are only used for motors and in conjunction with the corresponding digital speed inputs.

Four Outputs (Analog)

Output voltage	maximum ±10.3 V; maximum load 5 mA, short-circuit protected, shared LO connection to ground potential
Allowable external voltage	maximum 50 Vrms at HI input
Additional error	±(0.15 % of AVG + 0.05 % of FV), final value FV = 10 V
Temperature coefficient	<0.2 x fault limit/K
Output rate	corresponds to current average time
Resolution	approximate ±8000 counts for ±10 V, 1 count ≈ 1.25 mV
Rise time	10 to 90 %: approximately 10 ms
Response time	to ±0.2 %: 25 ms
	to ±1.0 %: approximate 20 ms

Chapter 10

Measured Values Computation

Title	Page
Measured values per phase x (channel x – values are indexed x).....	10-3
Total values (sum or average).....	10-4
Frequency Analysis.....	10-6
Optional Process Interface Formulas	10-7

Measured values per phase x (channel x – values are indexed x)

For the majority of values, such as rms, power, calculated values as impedance, power factor, the corresponding ones of the fundamental “H01” are also available. Due to the frequent distortion by harmonics, it is often better to use H01 values for the phase shift between voltage and current (angle) or for the reactive power caused by inductive or capacitive load. However, a stable synchronization source must be present and selected.

RMS	$U_{RMS} = \sqrt{\frac{1}{T} \int_0^T u^2 \cdot dt}$	$I_{RMS} = \sqrt{\frac{1}{T} \int_0^T i^2 \cdot dt}$
Mean ^[1]	$U_M = \frac{1}{T} \cdot \int_0^T u \cdot dt$	$I_M = \frac{1}{T} \cdot \int_0^T i \cdot dt$
Rectified mean	$U_{RM} = \frac{1}{T} \cdot \int_0^T u \cdot dt$	$I_{RM} = \frac{1}{T} \cdot \int_0^T i \cdot dt$
Positive peak	$U_{P+} = \text{MAX}(u)$	$I_{P+} = \text{MAX}(i)$
Negative peak	$U_{P-} = \text{MIN}(u)$	$I_{P-} = \text{MIN}(i)$
Peak-to-Peak	$U_{PP} = U_{P+} - U_{P-}$	$I_{PP} = I_{P+} - I_{P-}$
Crest factor ^[2]	$U_{CF} = \frac{U_P}{U_{RMS}}$	$I_{CF} = \frac{I_P}{I_{RMS}}$
Form factor	$U_{FF} = \frac{U_{RM}}{U_{RMS}}$	$I_{FF} = \frac{I_{RM}}{I_{RMS}}$
Rectified mean corrected	$U_{RMC} = U_{RM} \cdot 1,1107$	$(U_{RM} \cdot \frac{\pi}{2 \cdot \sqrt{2}}) \text{ - not for current}$
Harmonic distortion ^[3]	$U_{THD} = \frac{\sqrt{U_{RMS}^2 - U_{H01}^2}}{U_{H01}}$	$I_{THD} = \frac{\sqrt{I_{RMS}^2 - I_{H01}^2}}{I_{H01}}$
Harmonic content ^[4]	$U_{HC} = \frac{\sqrt{U_{RMS}^2 - U_{H01}^2}}{U_{RMS}}$	$I_{HC} = \frac{\sqrt{I_{RMS}^2 - I_{H01}^2}}{I_{RMS}}$
Fundamental content	$U_{FC} = \frac{U_{H01}}{U_{RMS}}$	$I_{FC} = \frac{I_{H01}}{I_{RMS}}$

Note

In W3 system, voltages listed above are both available for the phase voltage U_x (measured) and for the phase-to-phase voltage U_{xy} (calculated). In W2 system, the phase-to-phase voltage U_{xy} is directly connected to the input of the channel and measured. Phase voltage values are unavailable.

Phase shift of fundamental to reference (sync)	φU_{H01}	φI_{H01}
Active Power	$P = \frac{1}{T} \cdot \int_0^T u \cdot i \cdot dt$	

Apparent power	$S = U_{RMS} \cdot I_{RMS}$	
Reactive power ^[4]	$Q = \sqrt{S^2 - P^2}$ (+...inductive, -...capacitive)	
Corrected Power ^[5]	$P_c = P \cdot \left(2 - \frac{U_{FF}}{1,1107}\right) = P \cdot \left(2 - \frac{U_{rms}}{U_{rm,1,1107}}\right)$ (Standard EN60076-1)	
Power factor	$\lambda = \frac{P}{S}$	
Phase shift ^[6]	$\varphi = \arccos \lambda$	
Impedance	$Z = \frac{S}{I_{RMS}^2}$	
Serial components	$R_S = \frac{P}{I_{RMS}^2}$	$X_S = \frac{Q}{I_{RMS}^2}$
Parallel components	$R_P = \frac{U_{RMS}^2}{P}$	$X_P = \frac{U_{RMS}^2}{Q}$
Energy by the integration function for P (separately for positive and negative P)	$E = \int u \cdot i \cdot dt$	

Notes

- [1] Mean value of pure (AC) sine = 0.
- [2] For crest factor calculation the greater absolute value of positive and negative peak is taken.
- [3] The standard method to calculate THD and HC is defined by the sum of the single harmonics. These individual values are not commonly available in the NORMA Power Analyzer. The method used here (replacement by calculation from fundamental and RMS) adds a deviation in the case of interharmonics only.

Harmonic content (according to DIN): $U_{hc} = k = \frac{\sqrt{U_{H2}^2 + U_{H3}^2 + \dots + U_{Hn}^2}}{\sqrt{U_{H1}^2 + U_{H2}^2 + \dots + U_{Hn}^2}}$	Harmonic distortion (according to IEC): $U_{thd} = \frac{\sqrt{U_{H2}^2 + U_{H3}^2 + \dots + U_{Hn}^2}}{U_{H01}}$
--	--

- [4] Due to distortion (harmonics) and varying load, reactive power Q originates not only from phase shift. The sign of Q is taken from the phase shift test which could fail if no unambiguous phase shift between voltage and current is detectable.
- [5] For W3 system the user may opt to use voltage rms and rm from the phase voltage or the phase-to-phase voltage depending on the type of transformer. W2 system calculation is fixed to the phase-to-phase voltages (due to phase voltage not being available). In a N5000 instrument, if W2 system and phase voltage method is selected, P_c is only available for the second system (P_{ca}/P_{cs}/P_{ce}/P_c).
- [6] See also [3]. The phase shift φ for broad-band signals is in fact an artificial result, it conforms to a physical angle for sinusoidal signals only. Often it makes sense to use φ_{H01}, the phase shift of the fundamental voltage to the fundamental current, instead.

Total values (sum or average)

Some values may be unavailable for instruments equipped with 1, 2, 4, or 5 channels. The selection of system W2 is for channels 1-2 only (channel 3 can be used independently). Channels 4-5-6 of a NORMA 5000 are always configured as system W3.

Average value of the phase voltages

(RMS, RM, M, RMC, H01)
unavailable with W2

$$U_{\Delta} = \frac{U_1 + U_2 + U_3}{3}$$

W2: na

Average value of the ph-to-ph voltages

(RMS, RM, M, RMC, H01)

$$U_{\Delta} = \frac{U_{12} + U_{23} + U_{31}}{3}$$

W2: $U_{\Delta} = \frac{U_{13} + U_{23} + U_{12}}{3}$

Average value of the phase currents

(RMS, RM, M, H01)

$$I = \frac{I_1 + I_2 + I_3}{3}$$

W2: $I = \frac{I_1 + I_2}{2}$

Totals (sum) of power values

Active power $P = P_1 + P_2 + P_3$ W2: $P = P_1 + P_2$

Reactive power^[1] $Q = Q_1 + Q_2 + Q_3$ W2: $Q = Q_1 + Q_2$

Apparent power^[2] $S = S_1 + S_2 + S_3$ W2: $S = S_1 + S_2$

Corrected power^[3] $P_C = P_{C1} + P_{C2} + P_{C3}$ W2: $P_C = P_{C1} + P_{C2}$

Impedance^[4]

$$Z = \frac{U_{\Delta}^2}{\sqrt{P^2 + Q^2}}$$

Serial components

$$R_s = \frac{U_{\Delta}^2 \cdot P}{P^2 + Q^2} \quad X_s = \frac{U_{\Delta}^2 \cdot Q}{P^2 + Q^2}$$

Parallel components

$$R_p = \frac{U_{\Delta}^2}{P} \quad X_p = \frac{U_{\Delta}^2}{Q}$$

Total power factor

$$\lambda = \frac{P}{S}$$

Total phase shift^[5]

$$\varphi = \arccos \lambda$$

Energy by the integration function for P (separately for positive and negative P)

$$E = \int u \cdot i \cdot dt$$

Frequency of the selected channel

f_{XU} or f_{XI}

(voltage or current 1...3...6)

Interval of measurement

t_{AVG}

Time since start (reset)

t_{RAVG}

Notes:

- [1] Q1 and Q2 of a W2-system are internal values: $Q_1 = \sqrt{S_1^2 - P_1^2}$, $Q_2 = \sqrt{S_2^2 - P_2^2}$
- [2] S1 and S2 of a W2-system are internal values: $S_1 = U_{13} \cdot I_1 \cdot \sqrt{3}/2$, $S_2 = U_{23} \cdot I_2 \cdot \sqrt{3}/2$
- [3] The apparent power of W2 is calculated from 2 voltages and 2 currents in contrast to W3 system. This may lead to differences between W3 and W2 measurements in case of unbalanced system/loads.
- [4] The calculated values of total impedances represent average phase impedances on a symmetrical 3-wire wye-connected network corresponding to the measured total phase-to-phase voltages U_{Δ} and active and reactive power values P and Q.
- [5] The phase shift φ for broad-band signals is in fact an artificial result. It conforms to a physical angle for sinusoidal signals only. Often, it makes sense to use φ_{H01} , the phase shift of the fundamental voltage to the fundamental current, instead.

Frequency Analysis

Basic calculation method for analysis of harmonics is done by FFT algorithm (Fast Fourier Transform):

$$b_k = \frac{2}{T} \cdot \int_0^T f(t) \cdot \sin\left(2 \cdot \pi \cdot k \cdot \frac{t}{T}\right) \cdot dt$$

$$a_k = \frac{2}{T} \cdot \int_0^T f(t) \cdot \cos\left(2 \cdot \pi \cdot k \cdot \frac{t}{T}\right) \cdot dt$$

$$c_k = |b_k + j \cdot a_k| = \sqrt{(a_k^2 + b_k^2)}$$

T ... Analysis interval length (2^n data points)

k ... Order of the spectral component

$$Y_{C,k} = \frac{c_k}{\sqrt{2}}$$

Magnitude of spectral component k (RMS value)

$$Y_{C,0} = c_0 = \frac{1}{T} \cdot \int_0^T f(t) \cdot dt$$

DC value

Three different calculation methods are implemented:

1. FFT mode uses fixed sampling frequency. A Hanning window function (“Cosine Bell”) is applied on the input data to suppress spectral leakage from unsynchronized frequency components. Various frequency ranges from 0...310 Hz up to half of the instruments sampling frequency are available. An additional smoothing of the FFT result is applied to reduce the picket fence effect in magnitude caused by the windowing.
Results are available as RMS values only.
2. DFT mode. Unsmoothed results from FFT (see 1. above) are post-processed to derive fundamental frequency and magnitude of its integer harmonics by interpolation.
Results can be viewed as absolute RMS values or as relative % of fundamental.
3. STD mode (compliant to standard EN61000-4-7 Ed 2.1). This calculation uses a SW-based synchronization technique to run the FFT over an integer number of fundamental cycles, therefore no windowing is needed. Only intervals of 10 or 12 cycles ($f_{nom} = 50\text{Hz}$ or 60Hz , resp) are specified in the standard, some more are provided by the device for lower frequencies.

Different grouping modes of the spectral components can be selected:

Basic Spectral Components	$Y_{C,k}$	[rms] only
Harmonic Components	$Y_{H,h}$	[rms] or [% fundamental]
Harmonic Groups	$Y_{g,h}$	[rms] or [% fundamental]
Harmonic Subgroups	$Y_{sg,h}$	[rms] or [% fundamental]
Centered Inter-harmonic Subgroups	$Y_{isg,h}$	[rms] or [% fundamental]
Harmonic and Inter-harmonic Subgroups	$Y_{sg,h}, Y_{isg,h}$	[rms] or [% fundamental]

Note

For definitions and formulas see EN61000-4-7 Ed 2.1

For all grouping modes (except the Spectral Components) distortion factors are calculated:

Harmonic Components:	$THD_Y = \sqrt{\sum_{h=2}^{40} \left(\frac{Y_{H,h}}{Y_{H,1}}\right)^2}$ [%] only
Harmonic Groups:	$THDG_Y = \sqrt{\sum_{h=2}^{40} \left(\frac{Y_{g,h}}{Y_{g,1}}\right)^2}$ [%] only
Harmonic Subgroups:	$THDS_Y = \sqrt{\sum_{h=2}^{40} \left(\frac{Y_{sg,h}}{Y_{sg,1}}\right)^2}$ [%] only
Centered Inter-harmonic Subgroups:	$TIDS_Y = \sqrt{\sum_{h=2}^{40} \left(\frac{Y_{isg,h}}{Y_{sg,1}}\right)^2}$ [%] only
Harmonic and Inter-harmonic Subgroups:	$THDT_Y = \sqrt{\sum_{h=2}^{40} \left(\frac{Y_{sg,h}}{Y_{sg,1}}\right)^2 + \sum_{h=2}^{40} \left(\frac{Y_{isg,h}}{Y_{sg,1}}\right)^2}$ [%] only

Note

TIDS and THDT are not defined in the EN standard.

Optional Process Interface Formulas

Torque
$$M_d = S_{M_d} * \left(\frac{1}{T} \int_0^T u_{(t)} dt - Z_{M_d} \right)$$

M_d torque in Nm
 S_{M_d} scale factor for torque in Nm/V or in Nm/Hz
 Z_{M_d} zero offset for torque in V or in Hz
 $u_{(t)}$ analogue torque signal at measuring input
 or
 pulses of digital torque signal at measuring input
 T averaging interval in seconds

Speed (pulse input):
$$n = \frac{1}{S_n} * \left(\frac{1}{T} \sum_0^T pulses * 60 - Z_n \right)$$

n speed in 1/min
 S_n scale factor pulse transmitter in pulses/revolution
 Z_n zero offset for pulse transmitter in Hz (typically =0)
 T averaging interval in seconds

Speed (analogue input):
$$n = S_n * \left(\frac{1}{T} \int_0^T u_{(t)} dt - Z_n \right)$$

n speed in 1/min
 S_n scale factor for speed in rpm/V
 Z_n zero offset for speed in V
 $u_{(t)}$ analogue speed signal at measuring input
 T averaging interval in seconds

Mechanical Power $P_m = n * M_d * 2\pi/60$
 P_m mechanical power in W

Efficiency $\eta = \frac{P_m}{P} * 100\%$ (MOT) or $\eta = \frac{P}{P_m} * 100\%$ (GEN)

η efficiency
 P el. power reference
 P_m mechanical power

Slip $SL = \frac{f - \frac{n}{60} * p}{f} * 100\%$

p number of pole pairs
 f el. frequency [Hz]

Chapter 11

Technical Data

Title	Page
Technical Data Fluke NORMA 4000/5000	11-3
General Technical Data	11-3
Reference Conditions	11-3
Ambient Conditions.....	11-3
Standards	11-3
Interfaces	11-4
Data Memory.....	11-4
Configuration Memory	11-4
Channel Specifications	11-4
Voltage.....	11-4
Current	11-4
Frequency and Synchronization	11-5
Intrinsic Uncertainty (Reference Conditions) Voltage and Current	11-5
Intrinsic Uncertainty (Reference Conditions) Active Power	11-5
Block Diagrams	11-9
Overview	11-9
Voltage Channels.....	11-10
Current Channels.....	11-10

Technical Data Fluke NORMA 4000/5000

General Technical Data

	NORMA 4000	NORMA 5000
Compact system	With 1 to 3 phases	up to 6 phases
	Continuous averages	
Interface Commands	SCPI Vers.1999.0; legacy emulation of D5255 selectable	
Housing	Protection Class 1 metal housing, IP 40	
Weight	5 kg (11 lb)	7 kg (15 lb)
Dimensions (W,H,D)	237.0 mm (9.3 in.), 150.0 mm (3HU) (5.9 in.), 315.0 mm (12.4 in.)	447.0 mm (17.6 in.), 150.0 mm (3HU) (5.9 in.), 315.0 mm (12.4 in.)
Display	145 mm (5.7 in.), 320 x 240 pixel; background illumination and contrast adjustable	
Operation	Membrane keyboard, with cursor, function keys and direct functions	
Mains connection	85 to 264 V AC (47 to 440 Hz) 120 to 300 V DC, Euro plug with switch approximately 40 VA	approximately 65 VA
Measuring terminals	4 mm safety sockets, 2 each / input; (for current inputs optional binding post) shunt connection via BNC socket	
Calibration interval	2 years	

Reference Conditions

Temperature	23 °C ±1 °C (71.6 °F to 75.2 °F)
Humidity	< 60 % r.H.
Power supply	115 V / 230 V ±10 %
Power frequency	50 Hz / 60 Hz
Warm up period	> 30 minutes

Ambient Conditions

Operating temperature range	+5 to +35 °C (+41 °F to +95 °F)
Storage temperature range	-20 to +50 °C (-4 °F to +122 °F)
Climatic class	B2 (according to IEC 60654-1)
Relative humidity	maximum 85 %, noncondensing
Altitude	Below 2000 m

Standards

Electrical safety	
EN 61010-1/ 2. edition	1000 V CAT II (600 V CAT III) Degree of pollution 2, Protection class I
EN 61558	for transformer
EN 61010-2-031/61010-2-032	for accessories
Electromagnetic compatibility	
Emission	IEC 61326-1, class B
Immunity	IEC 61326-1 / industrial locations

Test voltages	
Mains input housing (earth ground connector)	1.5 kV ac
Mains connection measuring inputs	5.4 kV ac
Measuring inputs - housing	3.3 kV ac
Measuring inputs – measuring inputs	5.4 kV ac

Interfaces

RS232		RS232 interface for firmware upload and data exchange with PC; the device can be connected to a printer through an external adapter
IFC 1 Option	GPIB	IEEE 488.2 / 1 MBit/s
	LAN	Ethernet / 10 MBits/s or 100 MBits/s

Data Memory

Measured data memory	approximately 4 MB
----------------------	--------------------

Configuration Memory

The current instrument settings can be stored as configurations in a non-volatile memory for subsequent reloading. Changes that are not saved in a configuration are lost when the device is switched off. Up to 15 user-defined configurations can be permanently stored under predefined names.

Channel Specifications

Voltage

8 measuring ranges for U	0.3 – 1 – 3 – 10 – 30 – 100 – 300 – 1000 V
U pk	2 x measuring range
U max	1000 Vrms, 2000 Vpk continuous 1400 Vrms, 2000 Vpk, 10 seconds maximum
Input impedance	2 MΩ / 20 pF
Common mode rejection	120 dB at 100 kHz
Temperature coefficient	0.05 x intrinsic uncertainty / K

Current

	I direct 10 A maximum	I direct 20 A maximum
6 measuring ranges for I direct	30 to 100 mA - 0.3 – 1 – 3 – 10 A	60 to 200 mA - 0.6 – 2 – 6 – 20 A
I pk	2 x measuring range	
I max	12 A continuously 20 A 10 seconds maximum / 100 A 1 second maximum	24 A continuously 32 A 10 seconds maximum / 120 A 1 second maximum
Input impedance with integrated shunts		
Ranges	30, 100 mA: 1.4 ohm typical	60, 200 mA: 1 ohm typical
	0.3, 1 A: 0.25 ohm typical	0.6, 2 A: 0.2 ohm typical
	3, 10 A: 0.025 ohm typical	6, 20 A: 0.02 ohm typical
Measuring connection for shunt or probe		
BNC socket	100 kΩ / 200 pF	
Ranges	30 – 100 mV - 0.3 – 1 – 3 – 10 V	
U max	20 Vrms, 30 Vpk continuous 30 Vrms, 50 Vpk, 10 seconds maximum	
Common mode rejection	120 dB at 100 kHz	
Temperature coefficient	0.05 x intrinsic uncertainty / K	

Frequency and Synchronization

Range	0.2 Hz to Sample rate (102 kHz / 341 kHz / 1 MHz)
Measurement error	±0.01 % rdg
Channel selection	all channels U/I, or external input
Low-pass filter	optionally integratable, with 3 different limit frequencies
External Sync-input	Maximum 50 V, 0,2 Hz to sample rate
Sync-output	Pulsed TTL signal 5 V

Intrinsic Uncertainty (Reference Conditions) Voltage and Current

max. uncertainty kd + kg in ± % (of rdg + pf rmg)

	PP42	PP50	PP52	PP54	PP64
Sample Rate	341 kHz	1024 kHz	341 kHz		
Bandwidth	3 MHz	10 MHz	3 MHz		
45 to 65 Hz ^[1]					0.01 + 0.02
10 to 1000 Hz	0.1 + 0.1	0.05 + 0.05			0.03 + 0.02
@10 kHz	0.25 + 0.25	0.2 + 0.2			
@100 kHz	0.5 + 0.5	0.4 + 0.4			
DC to 10 Hz ^[2]	0.2 + 0.2	0.1 + 0.1			
1 to 10 kHz	(0.1+0.1)+(0.15+0.15)*log (f/1 kHz)	(0.05+0.05)+(0.15+0.15)*log (f/1 kHz)		(0.03+0.02)+(0.17+0.18)*log (f/1 kHz)	
10 to 100 kHz	(0.25+0.25)+(0.25+0.25)*log (f/10 kHz)	(0.2+0.2)+(0.2+0.2)*log (f/10 kHz)			
> 100 kHz	Gradually decreasing to -30% at upper cut-off-frequency				
[1] Anti-aliasing filter on, AC-coupling [2] Anti-aliasing filter on, DC-coupling, typical max. error Notes: Voltage Uncertainty (Failure): F_v in % of rdg = $\pm (kd + \frac{kg}{kv})$ V magnitude factor: $kv = \text{rdg (V)} \div \text{rng (V)}$ Current Uncertainty (Failure): F_i in % of rdg = $\pm (kd + \frac{kg}{ki})$ I magnitude factor: $ki = \text{rdg (I)} \div \text{rng (I)}$					

Intrinsic Uncertainty (Reference Conditions) Active Power

Nominal phase uncertainty ka in 1/1000 degree

Current Input	Frequency	PP42	PP50	PP52	PP54	PP64
BNC (external)	45...65 Hz ^[1]	10				2
BNC (external)	10...10 kHz	5 + 5/kHz				
Direct	45...65 Hz ^[1]	10				2.5
Direct	10...10 kHz	5 + 15/kHz	5+10/kHz	5+15/kHz	5+10/kHz	5 + 5/kHz
[1] Anti-aliasing filter on, AC-coupling Notes: Power Uncertainty (Failure): F_p in % of rdg = $\pm \left(F_v + F_i + ka \cdot kp \cdot \frac{\pi}{1.8} \cdot \sqrt{\frac{1}{PF^2} - 1} \right)$ PF = Power Factor, ka in degree $kp = \text{magnitude dependent phase error: } kp = \text{MAX} \left[1; \sqrt{\frac{1}{kv}}; \sqrt{\frac{1}{ki}} \right]$ kv, ki .100 % (over-range): kp=1						

Important key results of the preceding equation, see also Figures 11-1 through 11-3:

Conditions (AAF off)		PP42	PP50	PP52	PP54	PP64
V = 100 % I direct I = 100% PF = 1	45...65 Hz	0,40	0,20	0,20	0,20	0,10
	1 kHz	0,40	0,20	0,20	0,20	0,10
	10 kHz	1,00	0,80	0,80	0,80	0,80
	100 kHz	2,00	1,60	1,60	1,60	1,60
V = 100 % I direct I = 100% PF = 0.3	45...65 Hz	0,43	0,23	0,23	0,23	0,13
	1 kHz	0,51	0,28	0,31	0,28	0,16
	10 kHz	1,86	1,38	1,66	1,38	1,11
	100 kHz	10,35	7,18	9,95	7,18	4,40
V = 100 % I direc I = 100% f = 45...65 Hz	PF = 1	0,40	0,20	0,20	0,20	0,10
	0.3	0,43	0,23	0,23	0,23	0,13
	0.1	0,49	0,29	0,29	0,29	0,19
	0.03	0,69	0,49	0,49	0,49	0,39
V = 100 % I direct I = 50 f = 45...65 Hz	PF = 1	0,50	0,25	0,25	0,25	0,12
	0.3	0,54	0,29	0,29	0,29	0,16
	0.1	0,62	0,37	0,37	0,37	0,24
	0.03	0,91	0,66	0,66	0,66	0,53
V = 100 % I direct I = 10% f = 45...65 Hz	PF = 1	1,30	0,65	0,65	0,65	0,28
	0.3	1,39	0,74	0,74	0,74	0,37
	0.1	1,57	0,92	0,92	0,92	0,55
	0.03	2,22	1,57	1,57	1,57	1,20

PP64 (AAF on)		PF = 1	0.3	0.1	0.03	0.01
V = 100 % 45...65 Hz I direct	I = 100 %	0,06	0,07	0,10	0,21	0,50
	50%	0,08	0,10	0,14	0,29	0,70
	10%	0,24	0,28	0,38	0,70	1,62

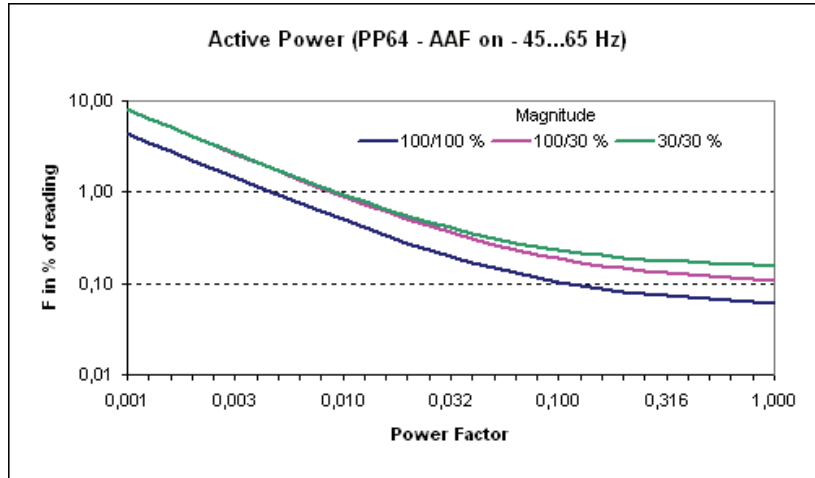

Figure 11-1. Active Power (PP64 – AAF on 45 to 65 Hz)

esn200.eps

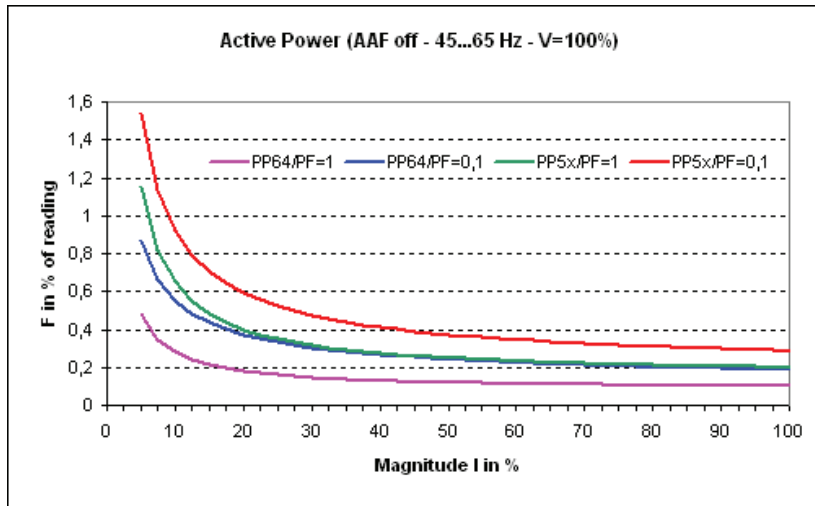

Figure 11-2. Active Power (AAF off - 45 to 65 Hz - V=100%)

esn201.eps

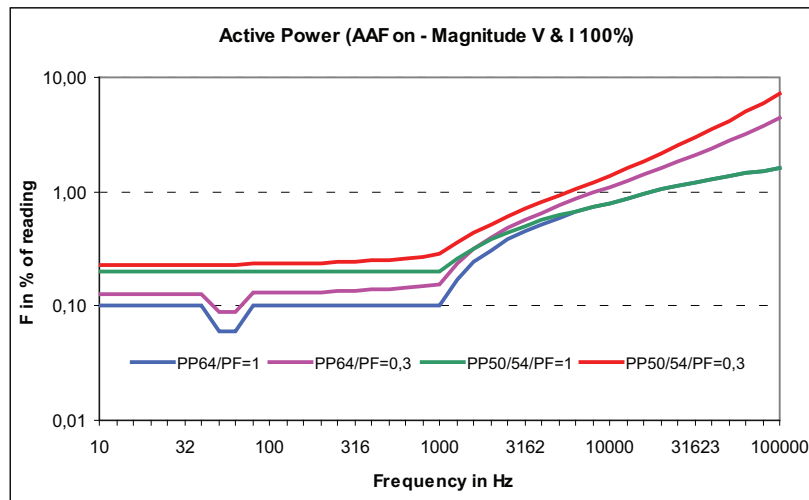

Figure 11-3. Active Power (AAF on - Magnitude V & I 100%)

esn202.eps

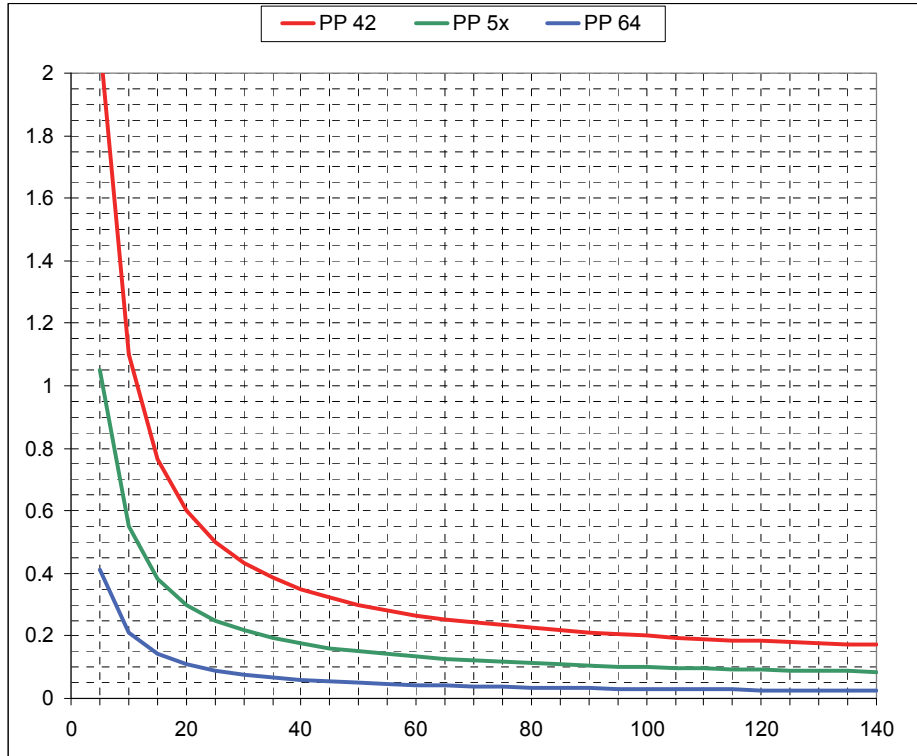

Figure 11-4. Linearity of U & I in % vs. rdg/rng in % (50/60 Hz)

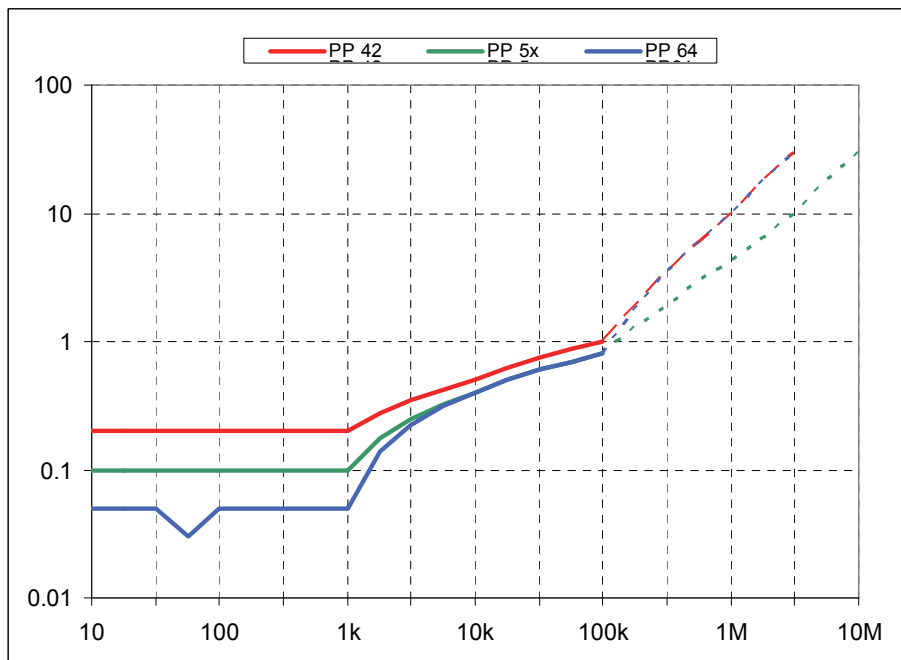
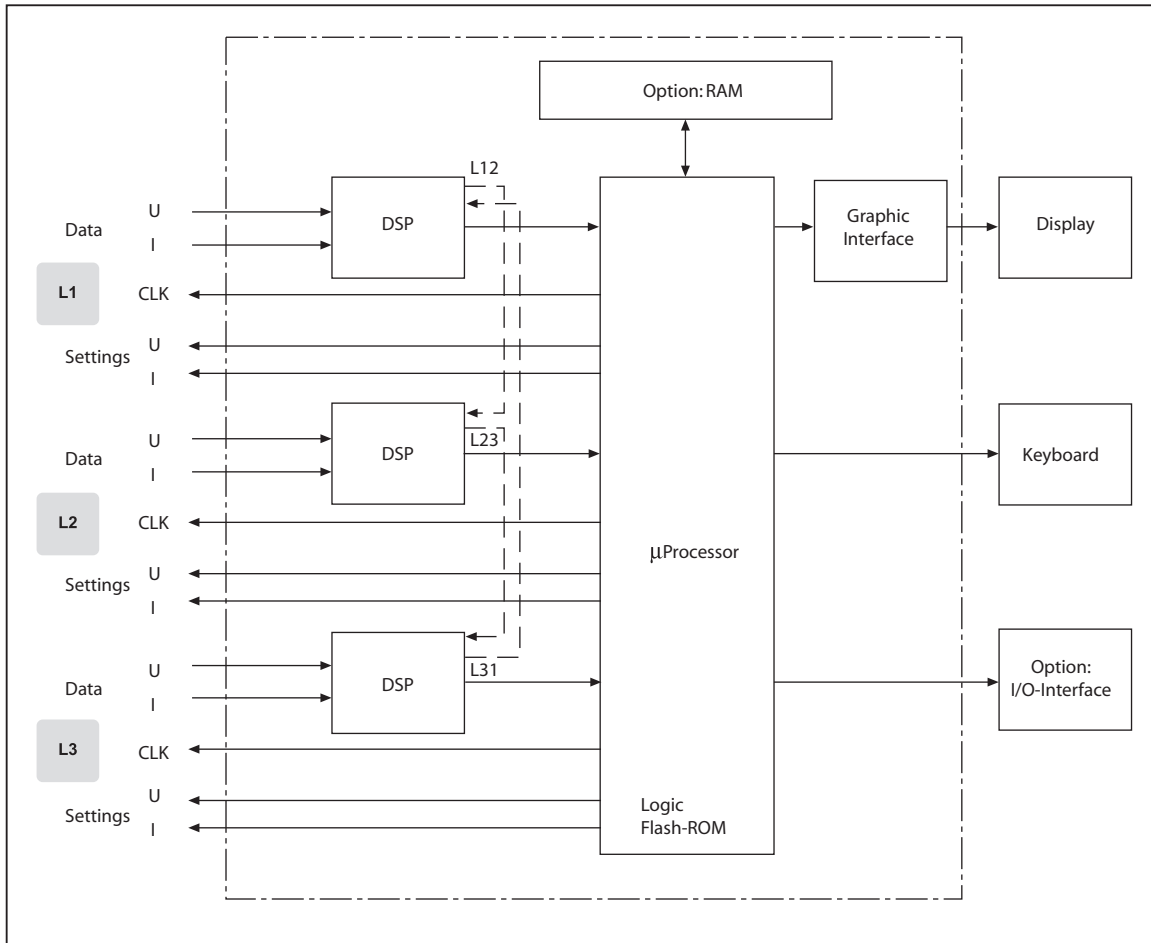

Figure 11-5. Uncertainty in % of U & I vs. Frequency (rdg/rng = 100%, antialiasing filter off)

Block Diagrams

Overview



esn073.eps

Voltage Channels

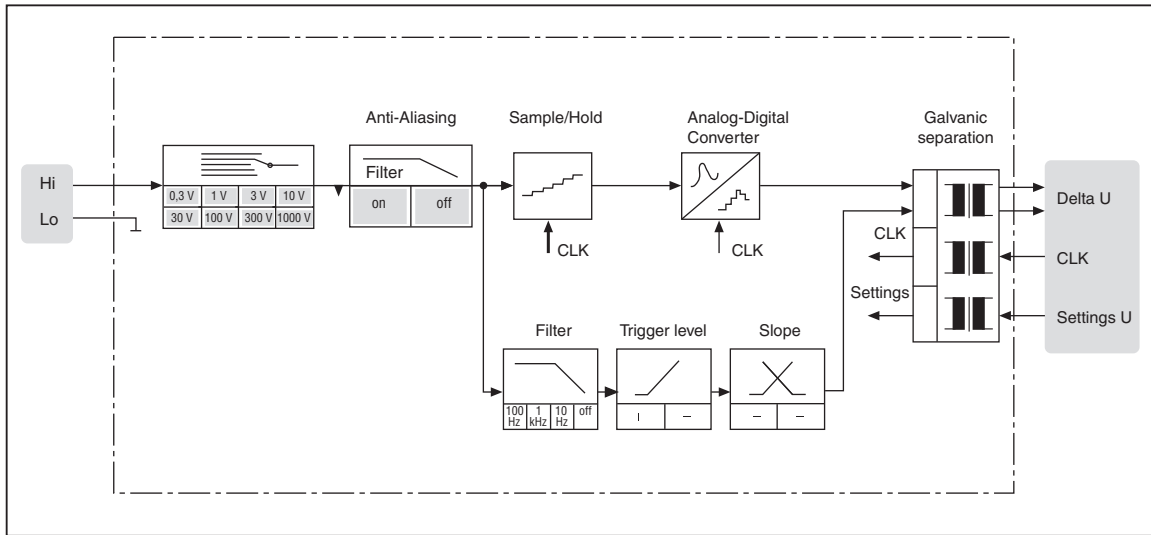

esn074.eps

Current Channels

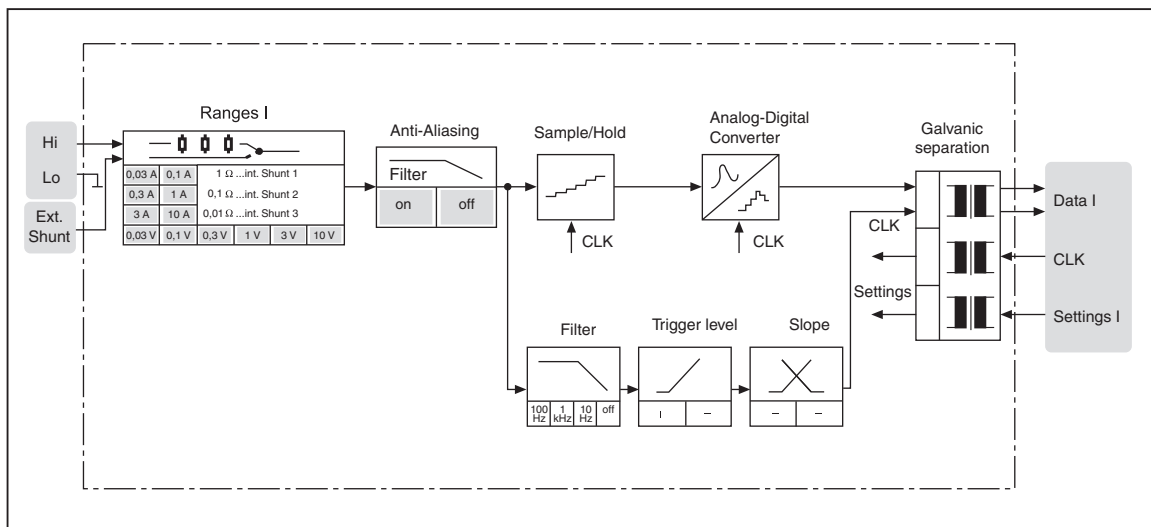

esn075.eps

Chapter 12

Service and Accessories

Title	Page
Instrument	12-3
Analyzer	12-3
Optional Equipment	12-3
Standard Equipment	12-3
Accessories	12-11
Accessories	12-11
Software	12-11
Service	12-12
General	12-12

Instrument

Analyzer

Fluke Model No.	Description/Technical Specifications
Fluke NORMA 4000	Basic unit 2/3 19", with power adapter, 5.7" color display, back lighted RS 232 interface for firmware upload, catering for 3 power phases and optional extensions
Fluke NORMA 5000	Basic unit 19", with power adapter, 5.7" color display, back lighted RS 232 interface for firmware upload, accommodating up to 6 power phases and optional extensions
PP 42	Power phase for voltage, current (20 A) and power measurement, bandwidth 3 MHz, sampling rate 1/3 MHz limit of error $\pm 0.1\%$ measured value and $\pm 0.1\%$ range
PP 50	Power phase for voltage, current (10 A) and power measurement, bandwidth 10 MHz, sampling rate 1 MHz limit of error $\pm 0.05\%$ measured value and $\pm 0.05\%$ range
PP 52	Power phase for voltage, current (20 A) and power measurement, bandwidth 3 MHz, sampling rate 1/3 MHz limit of error $\pm 0.05\%$ measured value and $\pm 0.05\%$ range
PP 54	Power phase for voltage, current (10A) and power measurement, bandwidth 3 MHz, sampling rate 1/3 MHz limit of error $\pm 0.05\%$ measured value and $\pm 0.05\%$ range
PP 64	Power phase for voltage, current (10A) and power measurement, bandwidth 3 MHz, sampling rate 1/3 MHz limit of error $\pm 0.025\%$ measured value and $\pm 0.025\%$ range

Optional Equipment

Fluke Model No.	Description/Technical Specifications
NORMA IFC 1 (IEEE-488 + Ethernet)	IEEE 488 and Ethernet Interfaces
NORMA Process IF	8 analog/pulse inputs, 4 analog outputs
NORMA 5000 Printer	Thermal printer for Fluke NORMA 5000
NORMA Printer Paper	Printer paper for NORMA 5000

Standard Equipment

A USB to Serial (RS 232) converter is supplied with the Power Analyzer. To install the driver:

1. Plug in the USB side of the cable to a free USB slot on your computer.
The New Hardware Wizard displays.

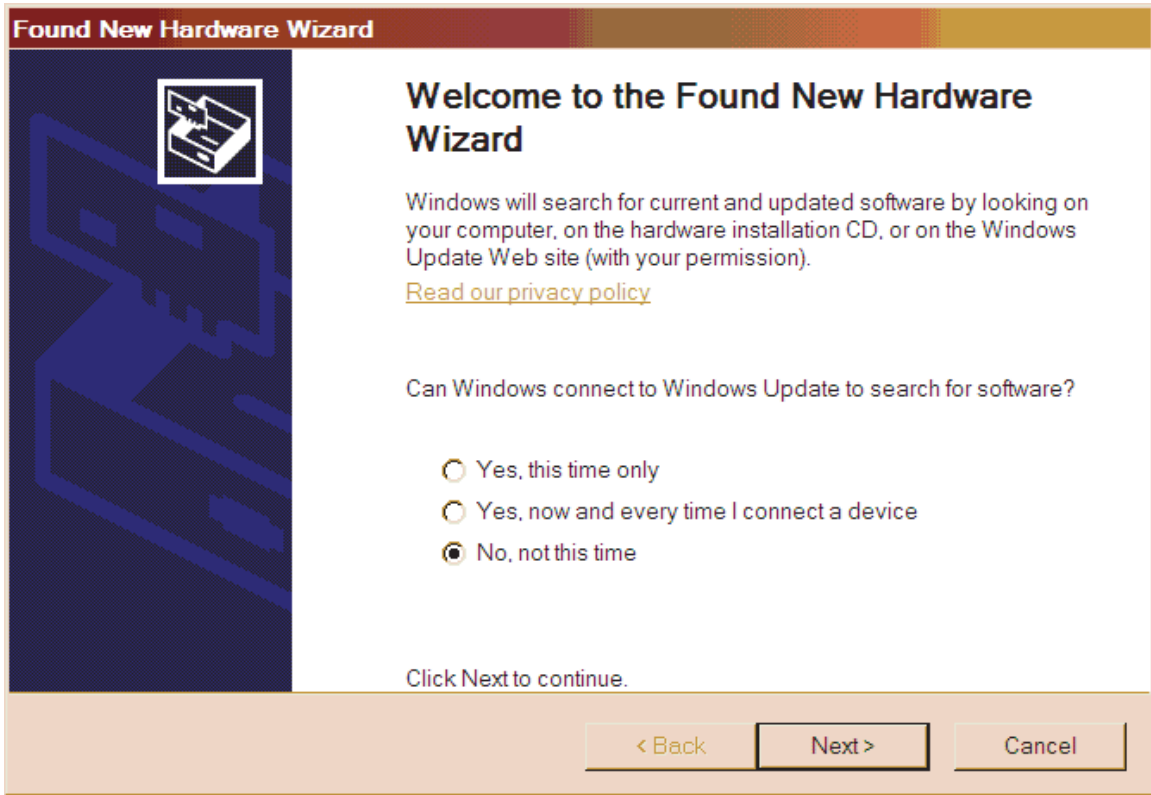

esn080.gif

2. Check “No, not this time.”
3. Press **Next**.
4. Insert the USB-to-serial-converter hardware CD.
5. Select “Install the software automatically.”
6. Press **Next**.

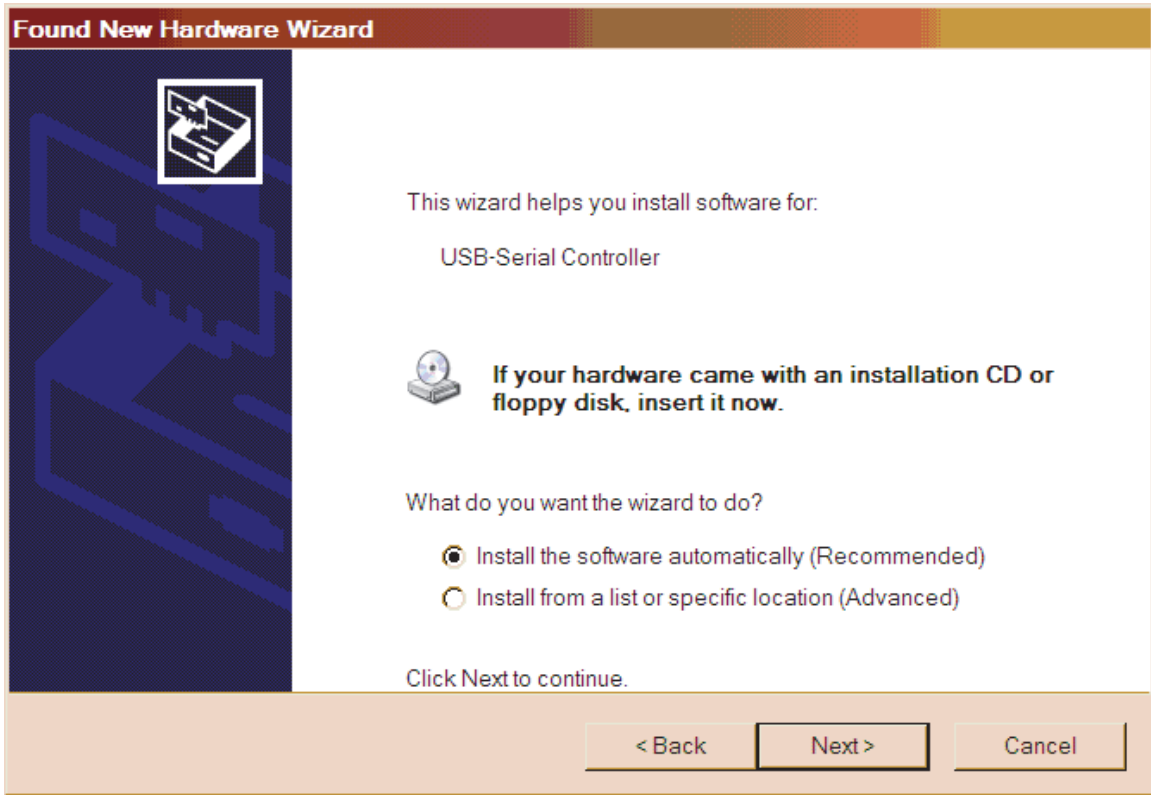

Windows will locate and copy the appropriate driver from the CD to your system and confirm the installation.

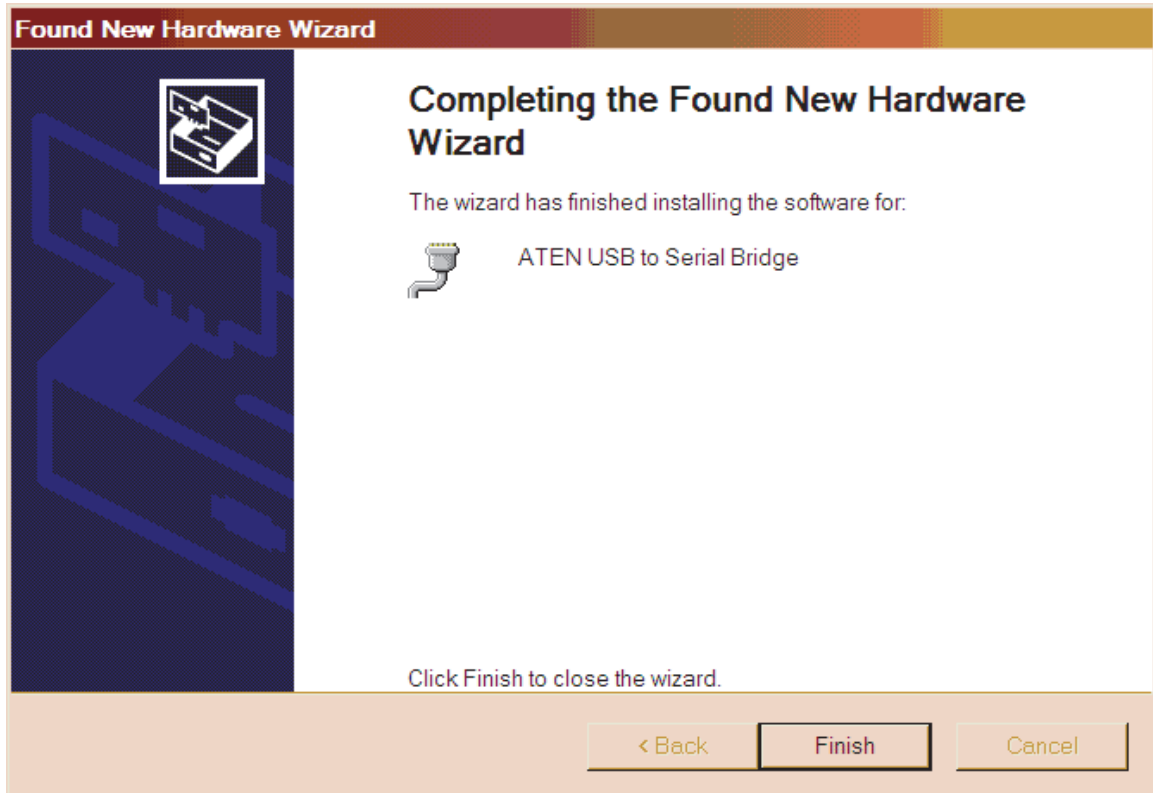

Note

The current implementation of Fluke NORMA View software is not capable of configuring the serial adapter settings (baud rate, stop bits, ...) directly. This must be done manually with a Windows configuration before starting NORMA View.

Go to:

Settings / Control Panel / Hardware / Device Manager / Ports (COM & LPT) / ATEN USB to Serial Bridge / Port Settings.

Your adapter may get a different virtual COM port number assigned than shown in the following sample screenshots.

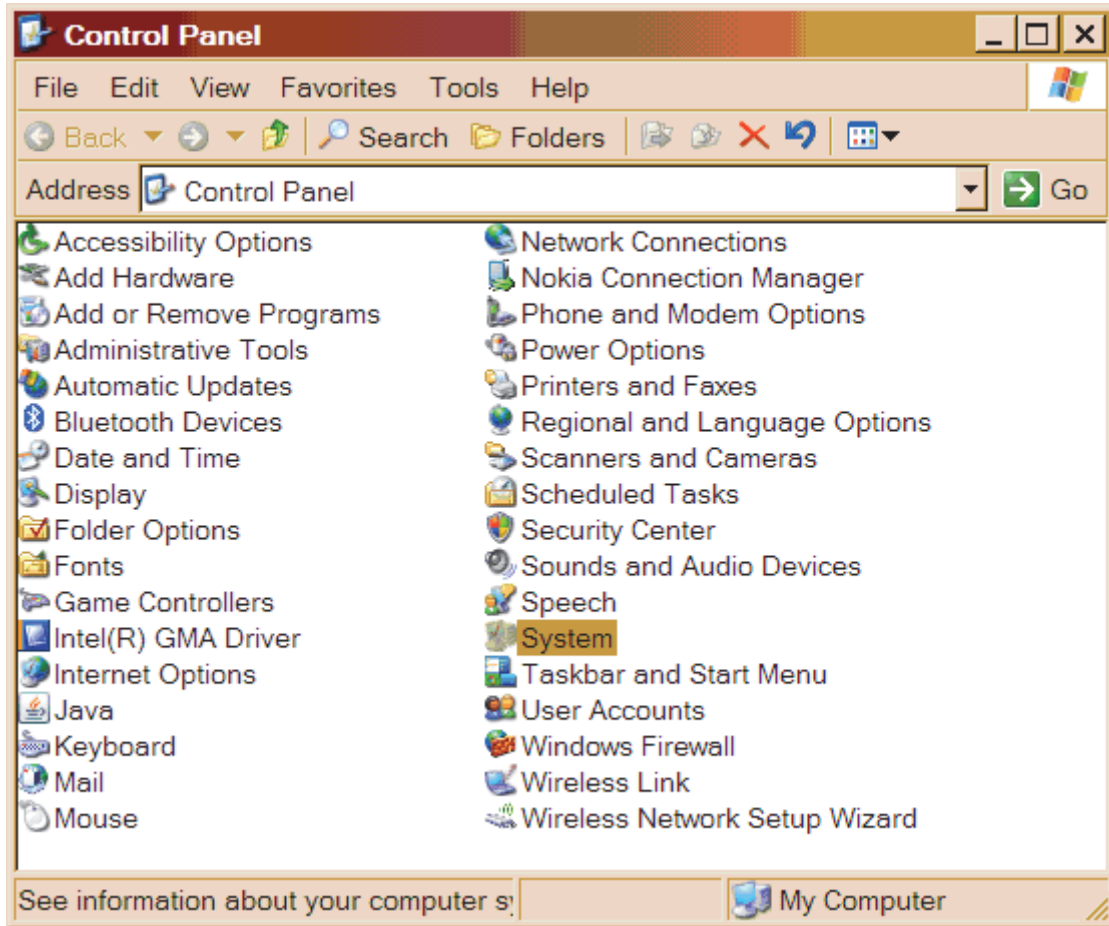

esn083.gif

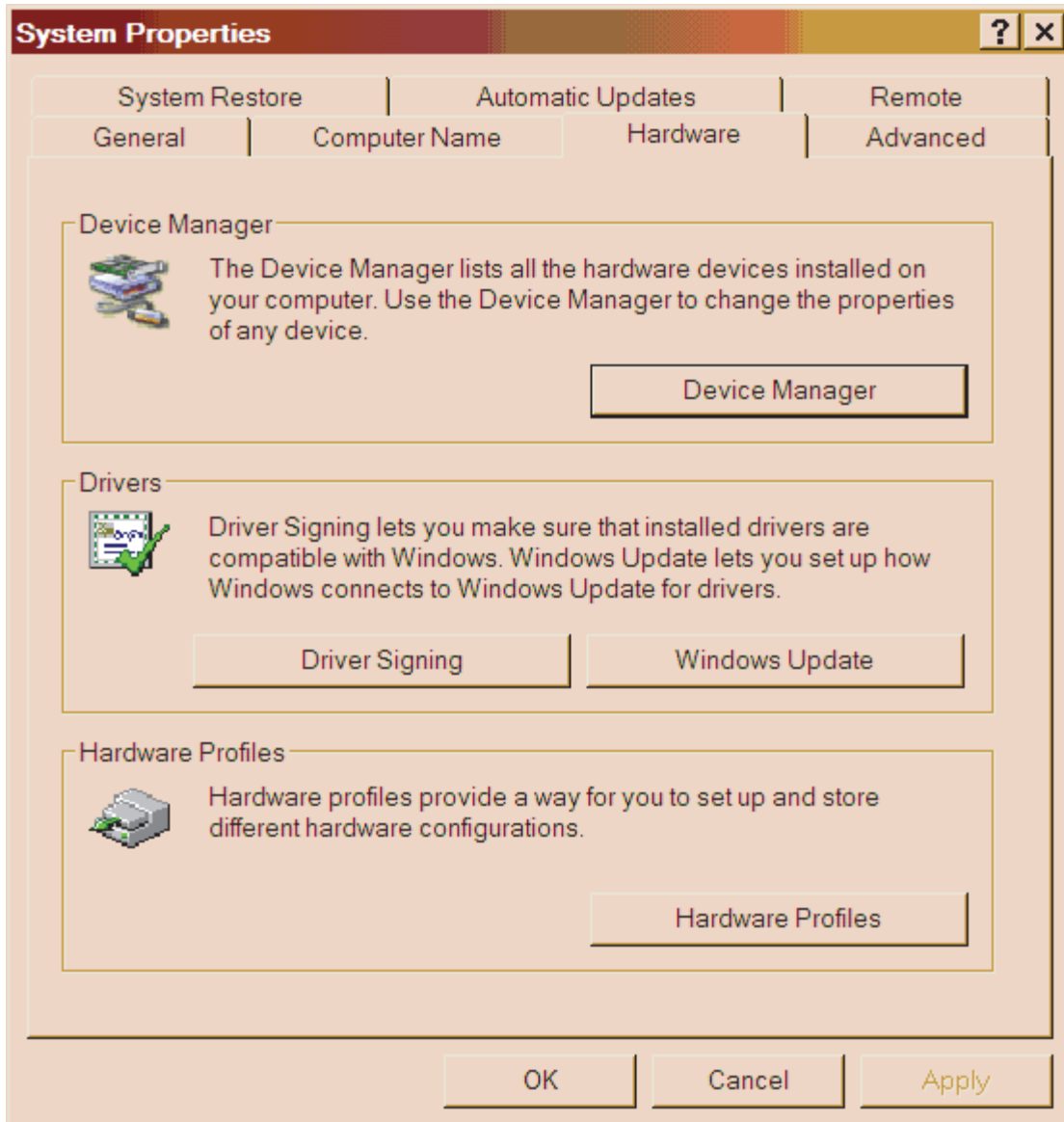

esn084.gif

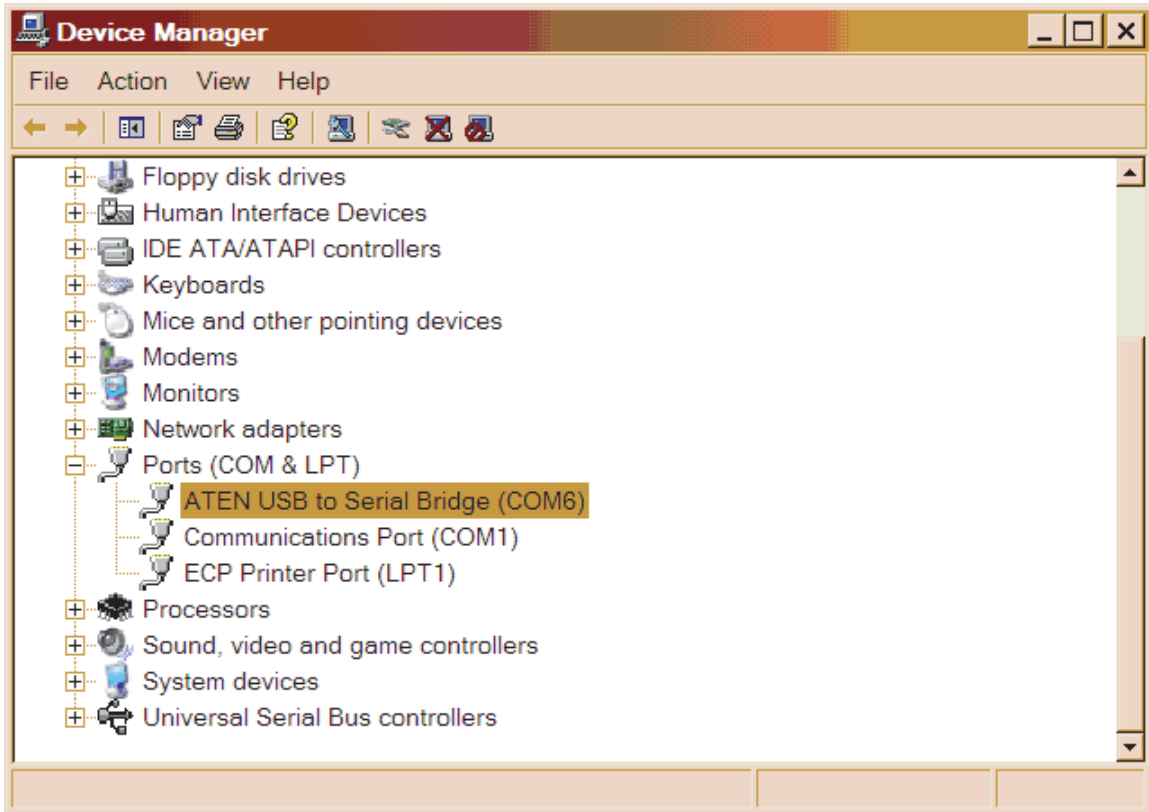

esn085.gif



esn086.gif

7. Match the settings in Windows to the configuration of your Power Analyzer. This information is in the General Setup screen.

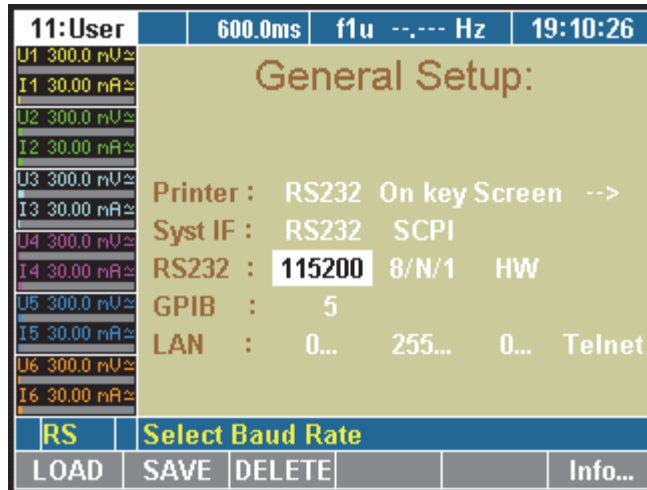

esn087.gif

Accessories

Accessories

Fluke Model No.	Description/Technical Specifications
NORMA Measurement Cable Set	Measuring lead set for power phase, cable length 1.5 m
NORMA Shunt 32A	32 A Shunt with Cables (10 mΩ, 0 to 1 MHz)
NORMA Shunt 100A	100 A Shunt with Cables (0.2 mΩ, 0 to 1 MHz)
NORMA Shunt 150A	150 A Shunt with Cables (0.5 mΩ, 0 to 0.5 MHz)
NORMA Shunt 300A	300 A Shunt with Cables (0.06 mΩ, 0 to 0.5 MHz)
NORMA Shunt 500A	500 A Shunt with Cables (0.06 mΩ, 0 to 0.2 MHz)
NORMA Shunt 10A	10 A Triaxial Shunt with Cables (10 mΩ, 0 to 2 MHz)
NORMA Shunt 30A	30 A Triaxial Shunt with Cables (1 mΩ, 0 to 2 MHz)
NORMA 32A Shunt Cables	Measuring lead for 32A planar shunt, 1.5 m
NORMA Large Shunt Cables	Measuring lead for shunt, 1.5 m
NORMA Star Adapter	3-phase star point adapter

Software

Fluke Model No.	Description/Technical Specifications
NORMA View	Basic PC software package for numerical display including: <ul style="list-style-type: none"> • Plug-in "Motor" supports the motor process interface • Plug-in "Storage" Data memory functions, DSO • Plug-in "Harmonic" (FFT, Harmonic analysis)
LabView Driver	Driver for interfacing the NORMA 4000 and 5000 to a National Instruments LabView system.