

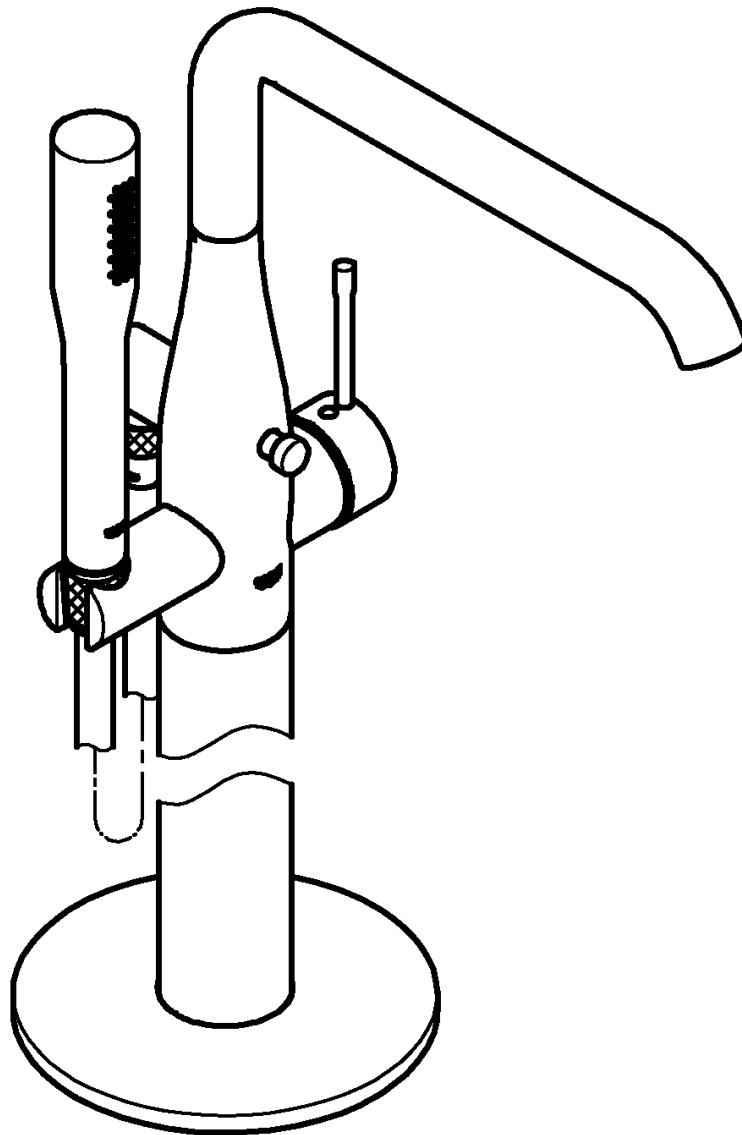

23 491



1



2

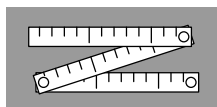

3 - 4

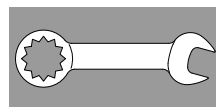

4

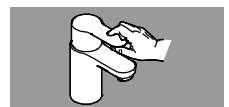

5

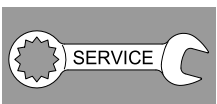

6



7



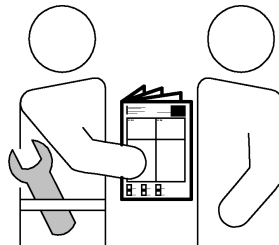
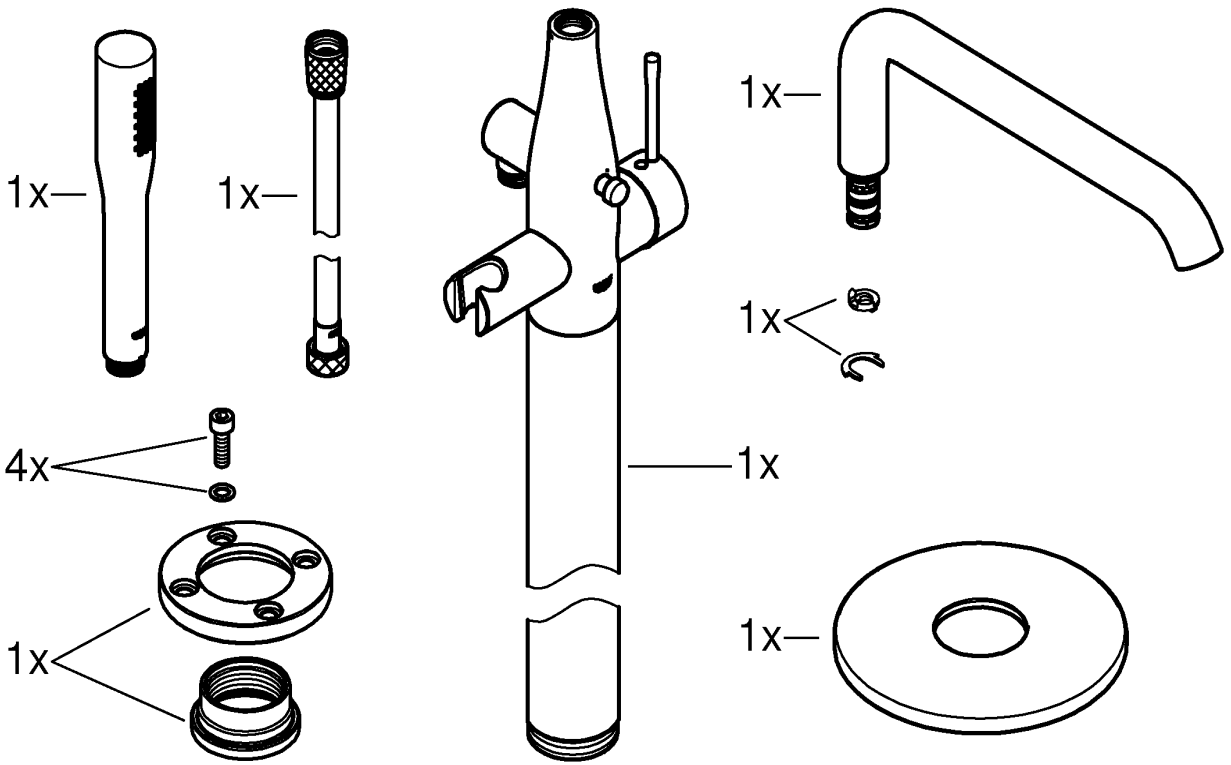

DIN 1988
DIN EN 806

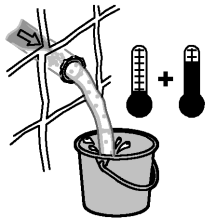

bar

max. 10 bar
0,5 bar
5 bar
1 bar

psi

max. 145 psi
7.25 psi
72.5 psi
14.5 psi

°C

max. 70°C
60°C

°F

max. 158°F
140°F

