

28 401

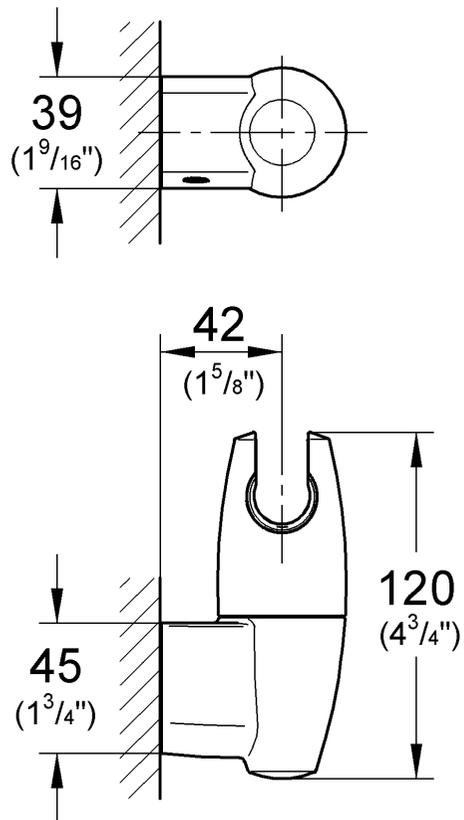

1.

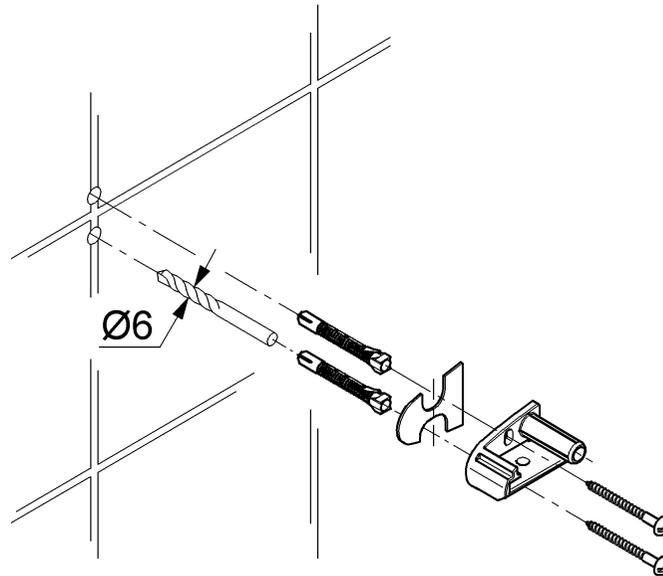

2.

