

31 126

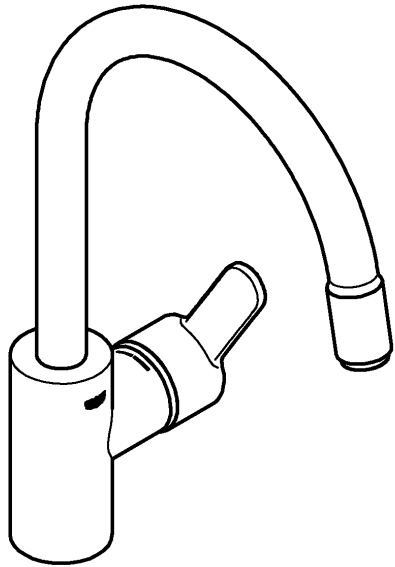

31 482

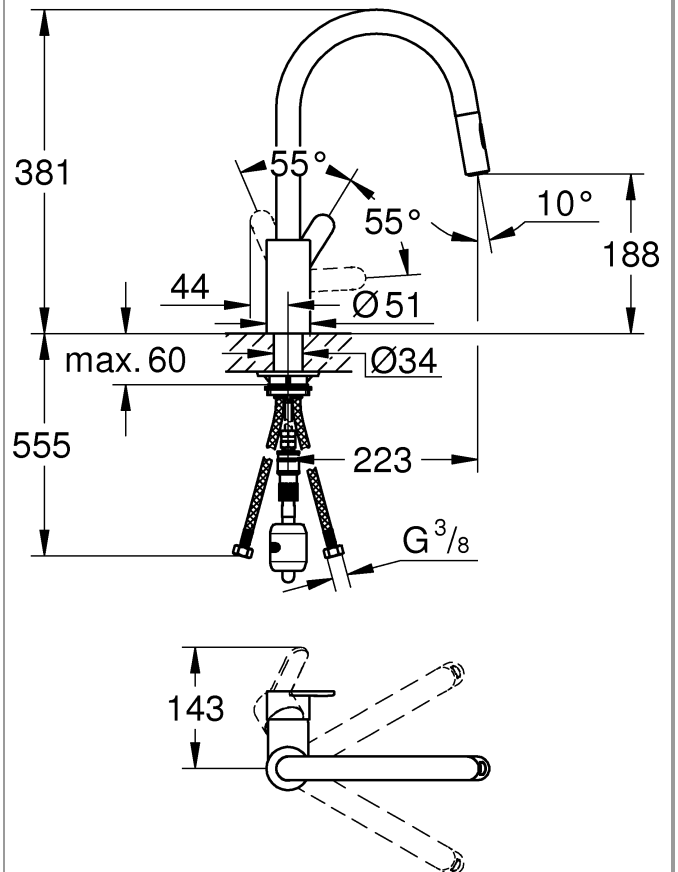

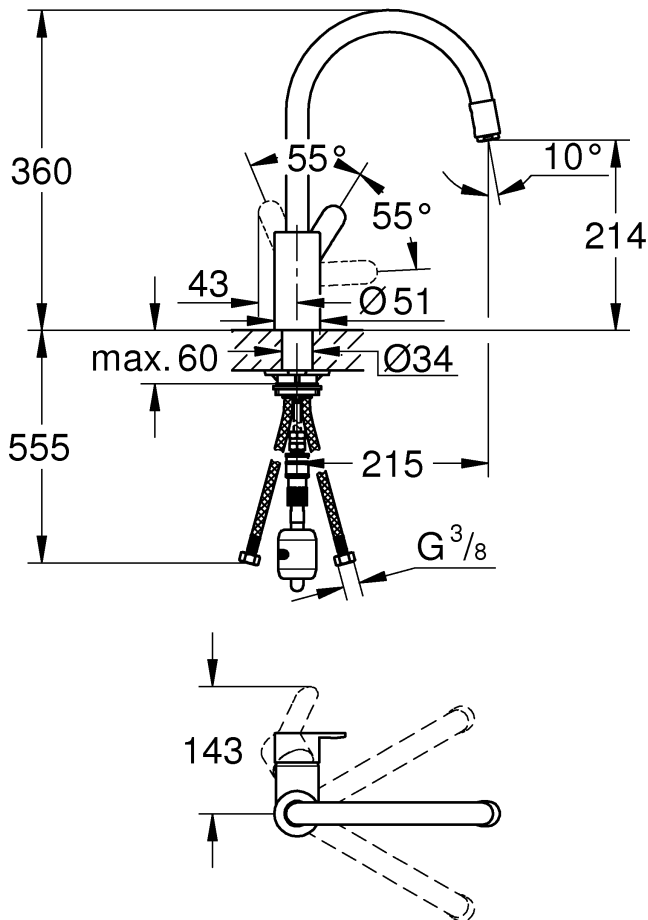
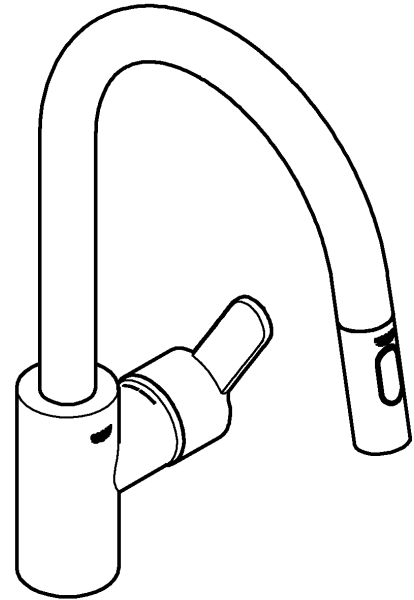

DIN 1988
DIN EN 806

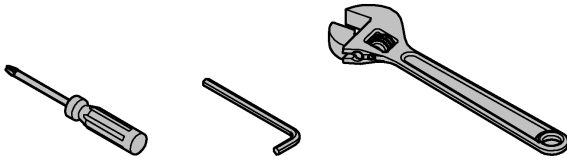
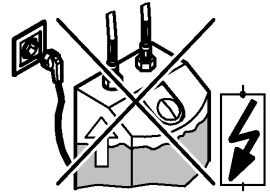
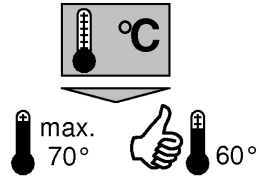
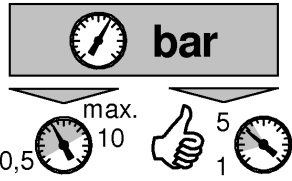
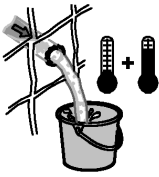

*19 332



32mm



1

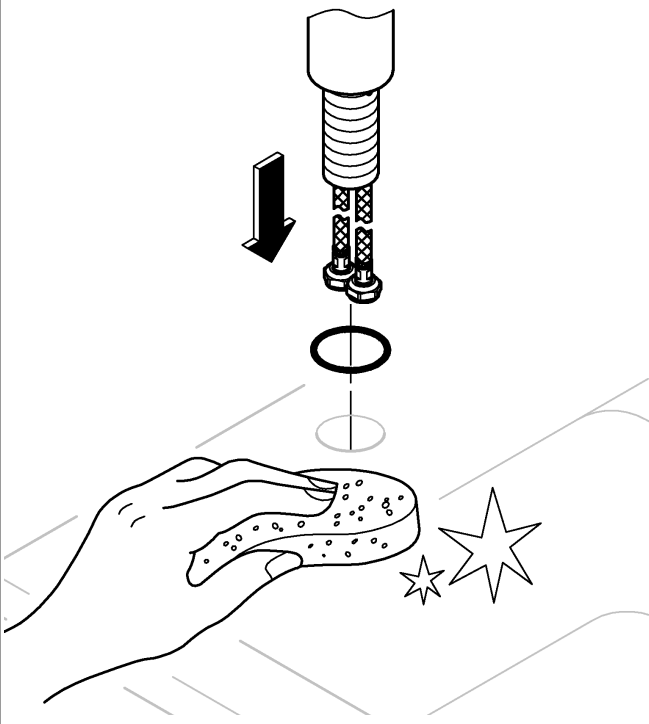

2

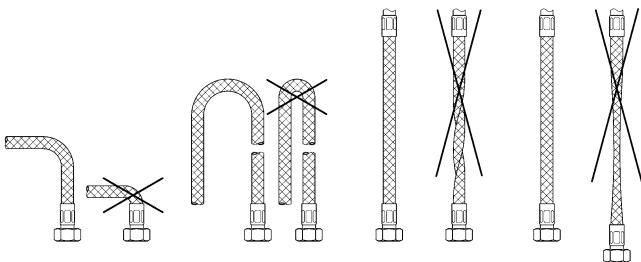
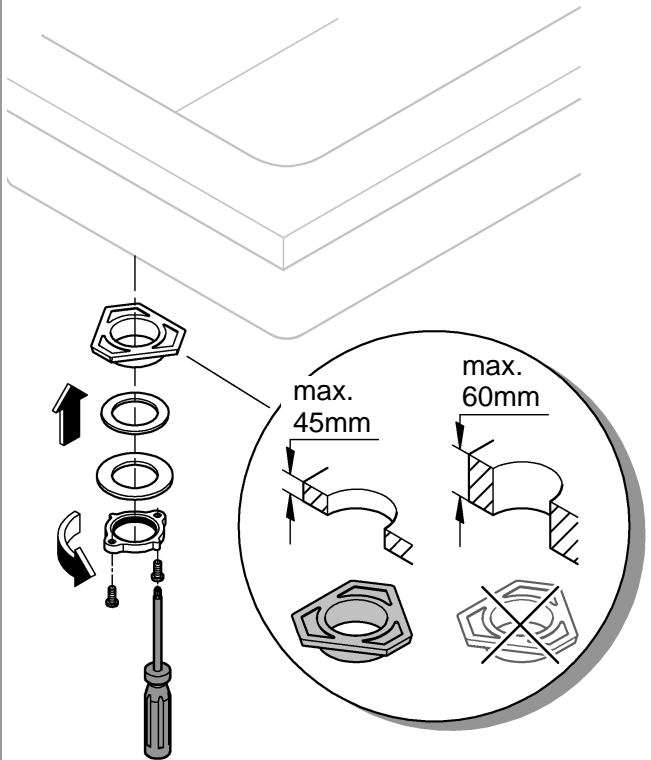



3

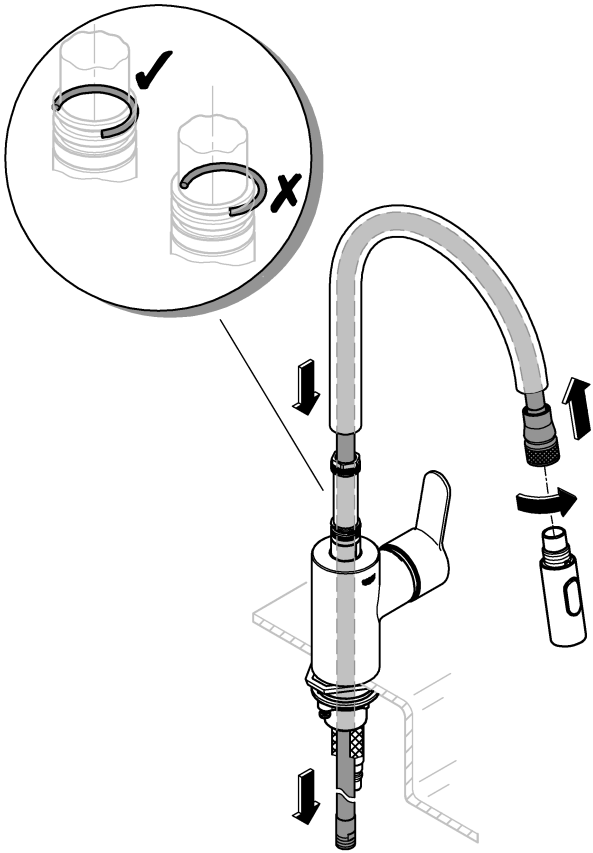

4

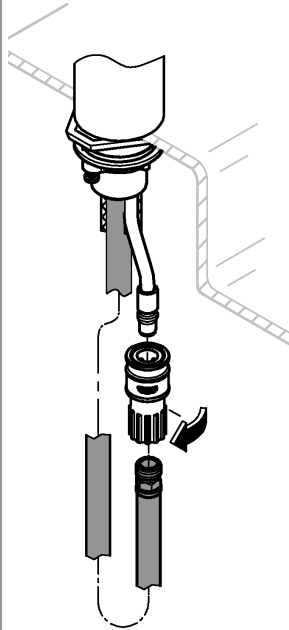

5

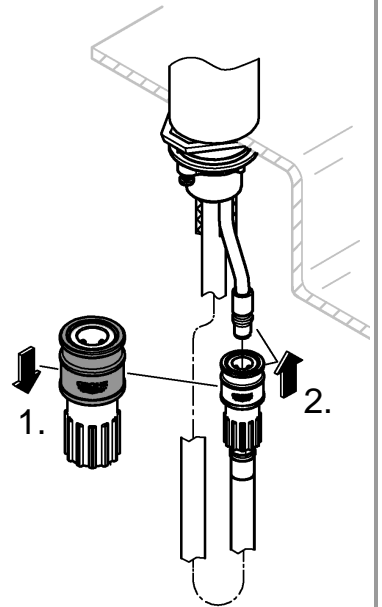

6

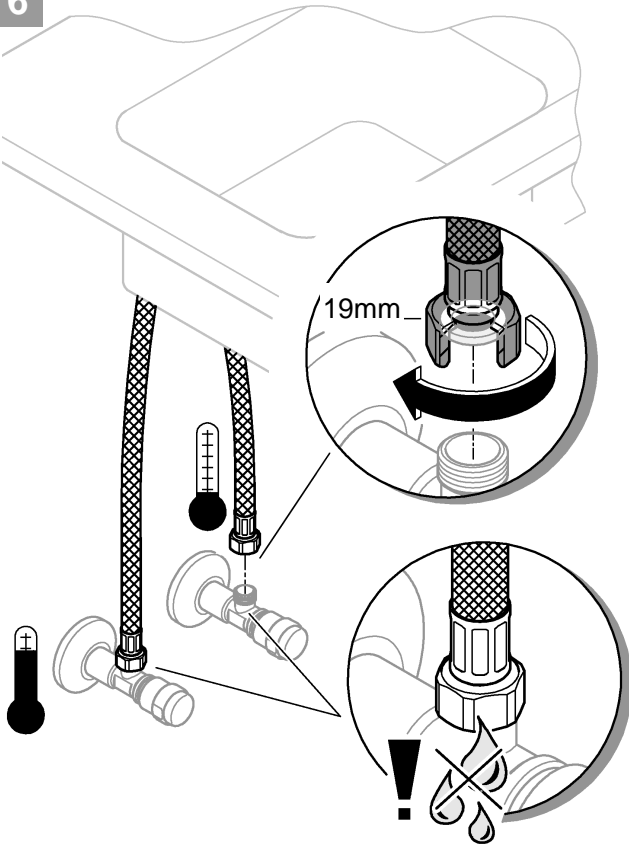

7

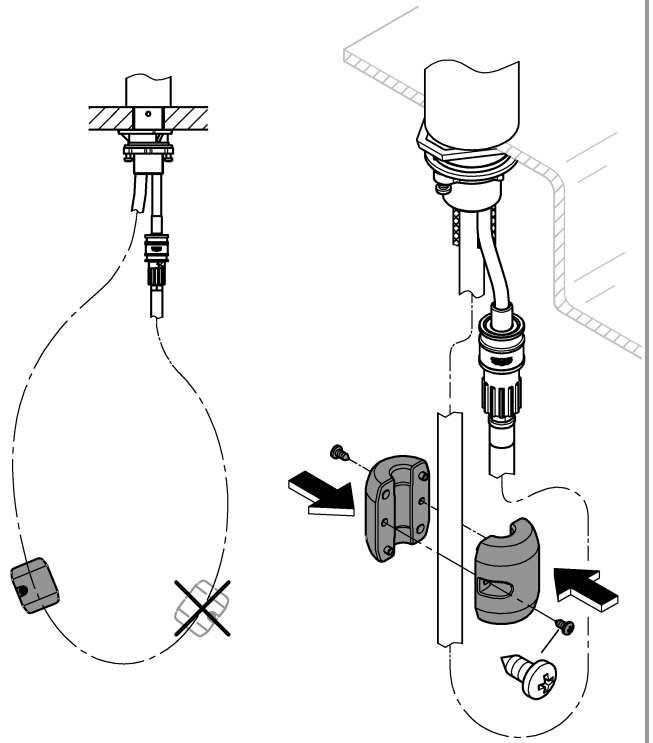



31 482

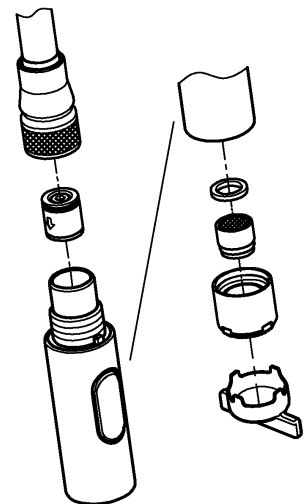
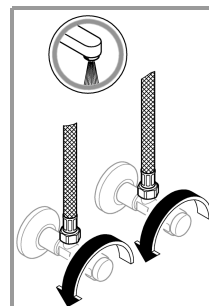
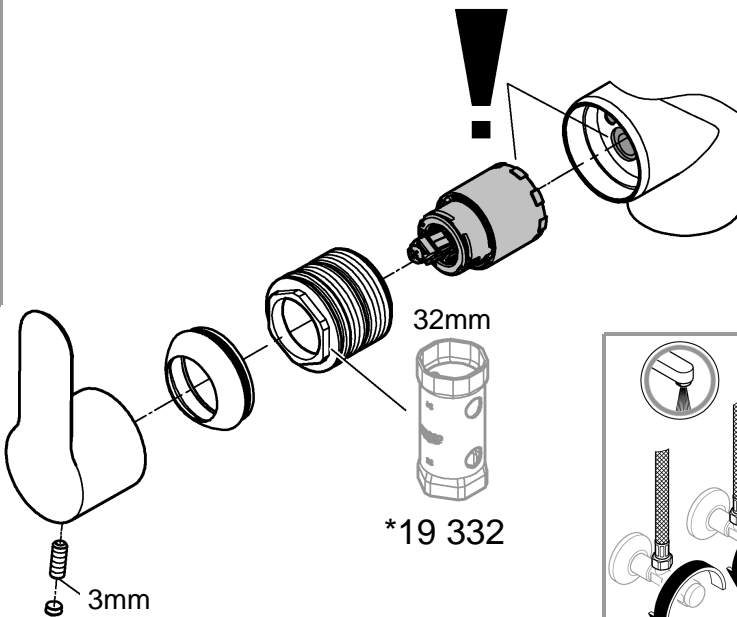
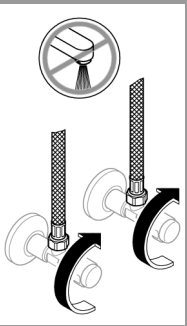
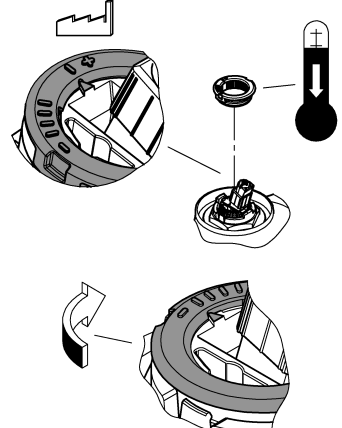
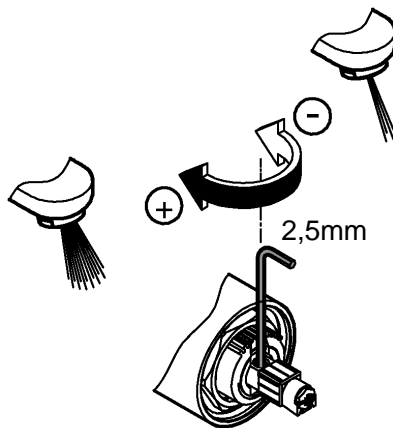
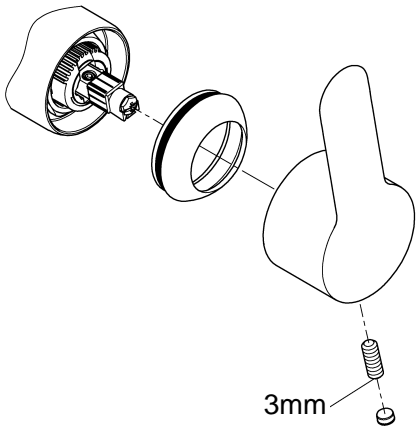
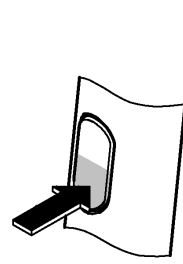
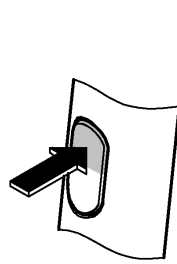
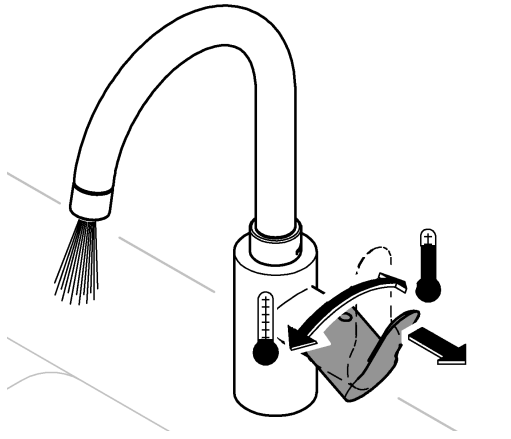

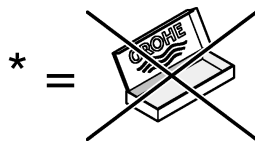
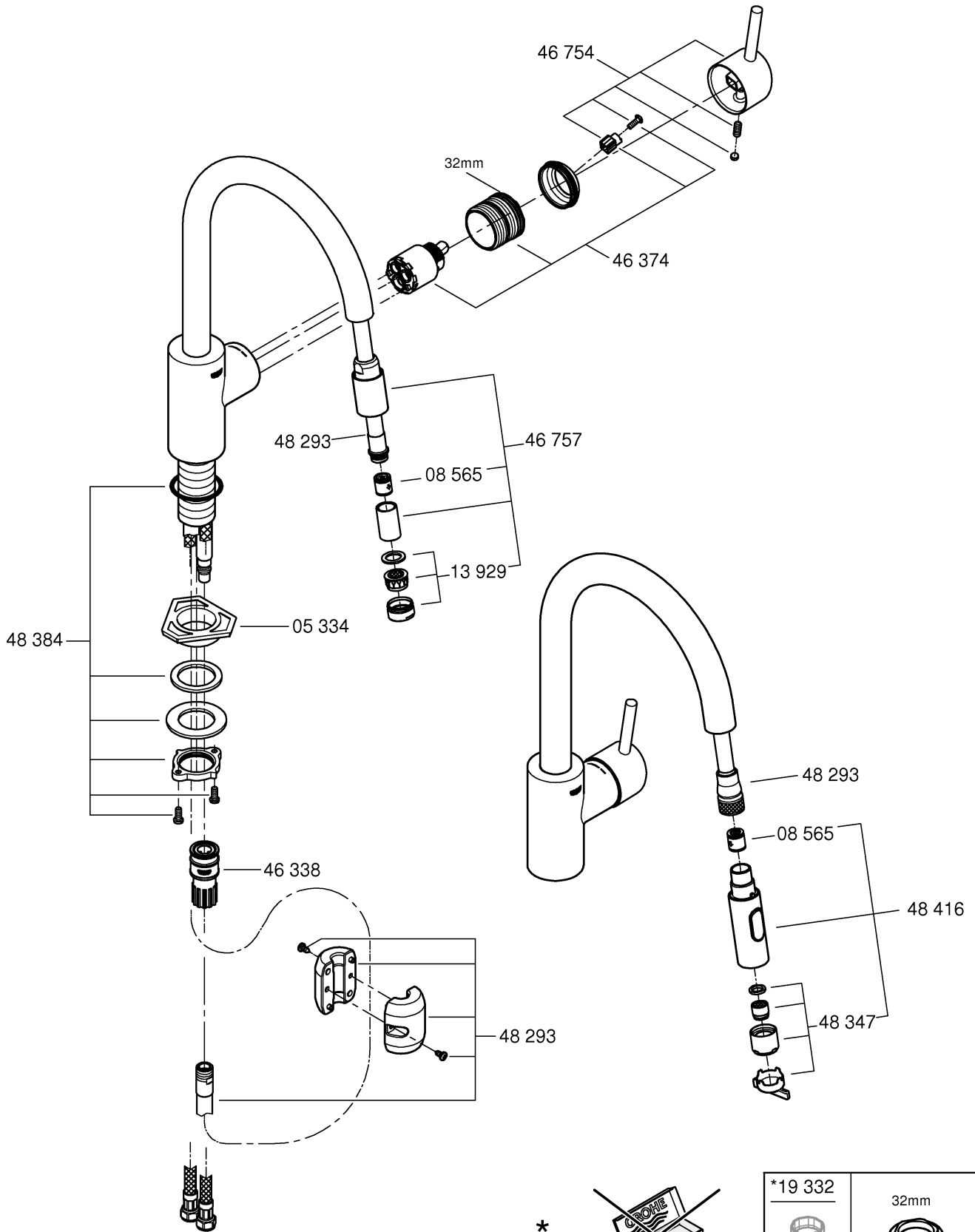

*19 332	32mm