

37 998
37 999
38 437
38 441

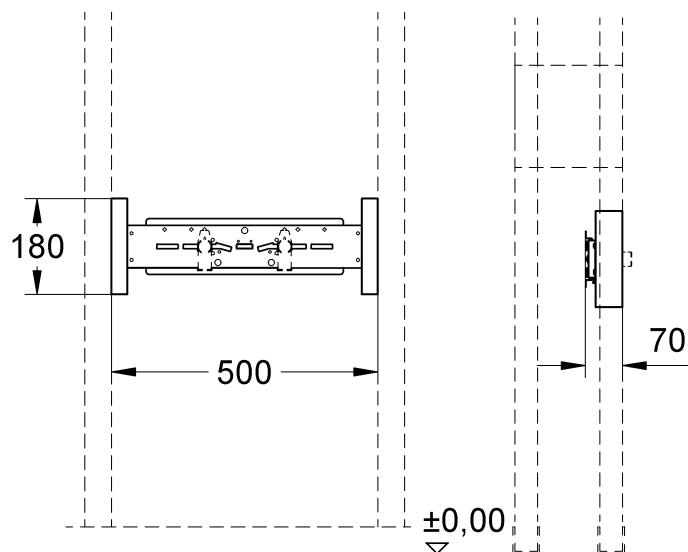

38 652

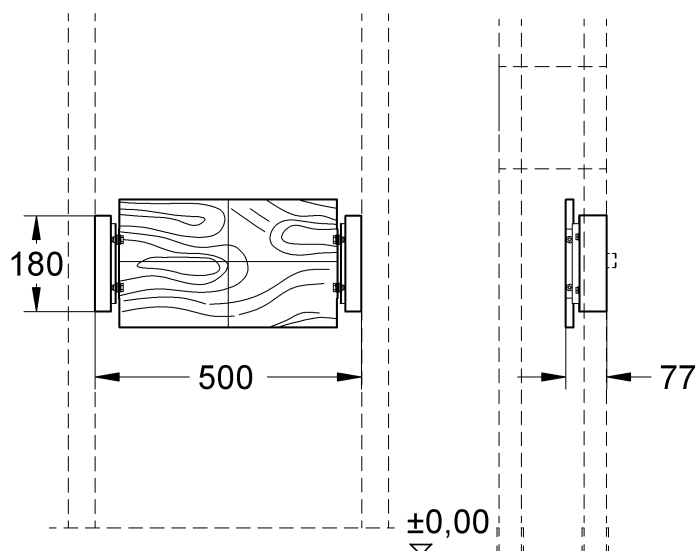

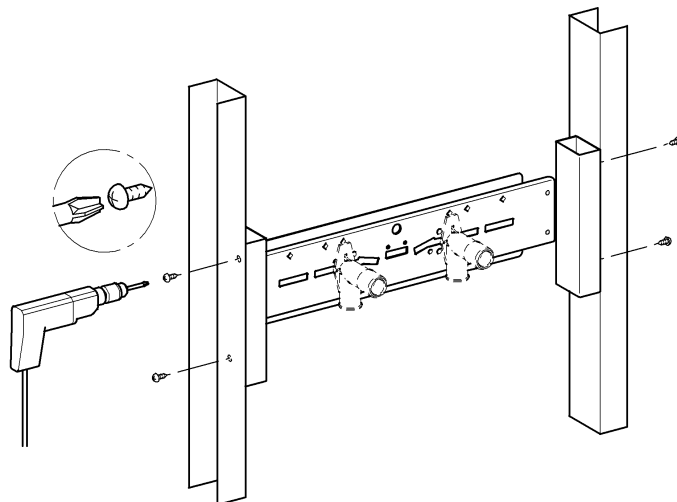
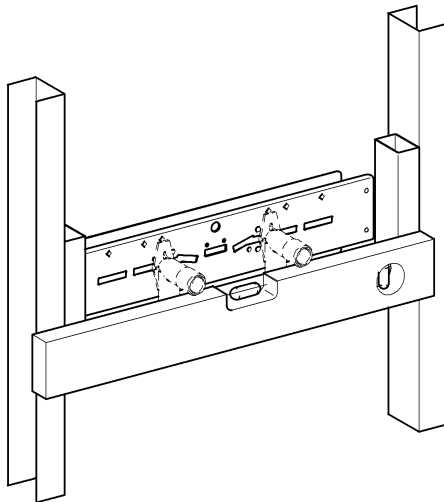
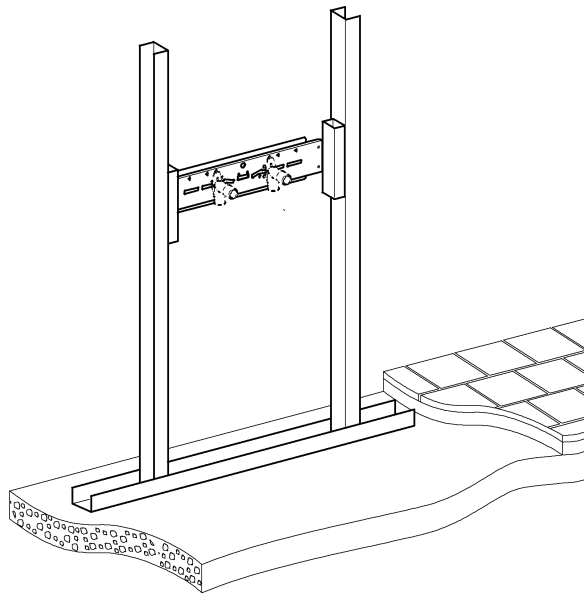

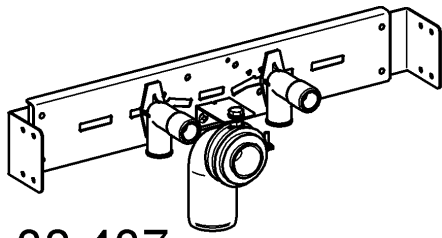

38 437

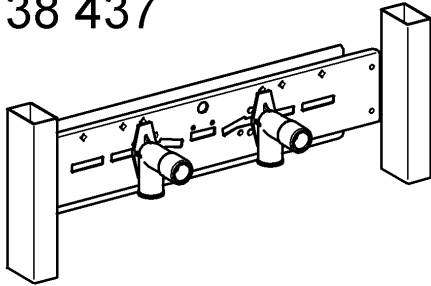

37 998

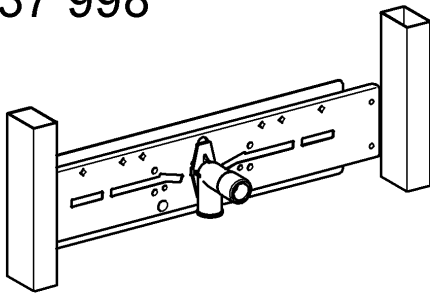

37 999

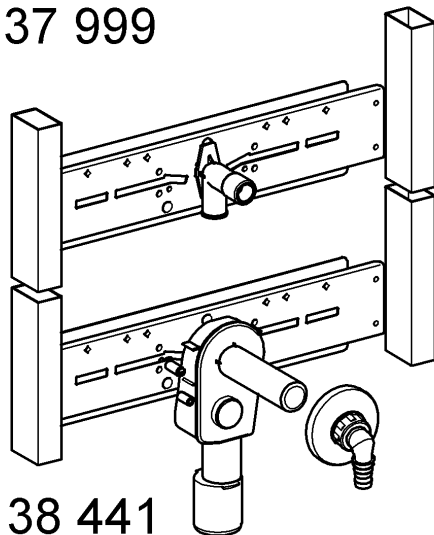

38 441

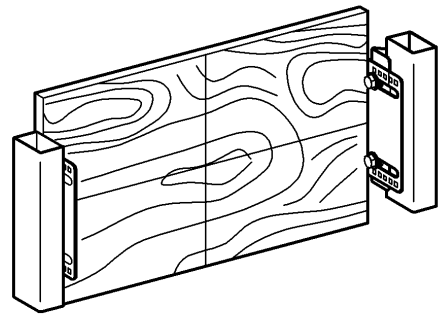

38 652