

38 733

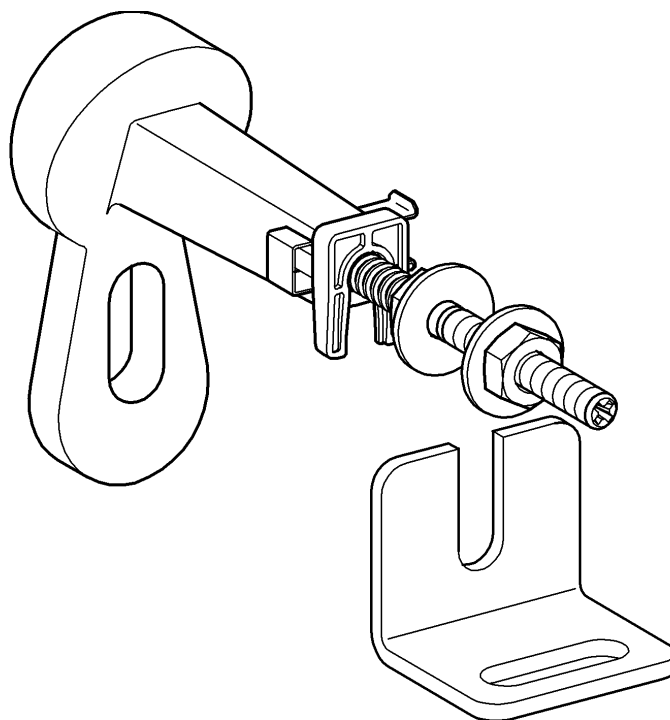

Design & Quality Engineering GROHE Germany

96.191.231/ÄM 218692/06.10

GROHE

ENJOY WATER®

