

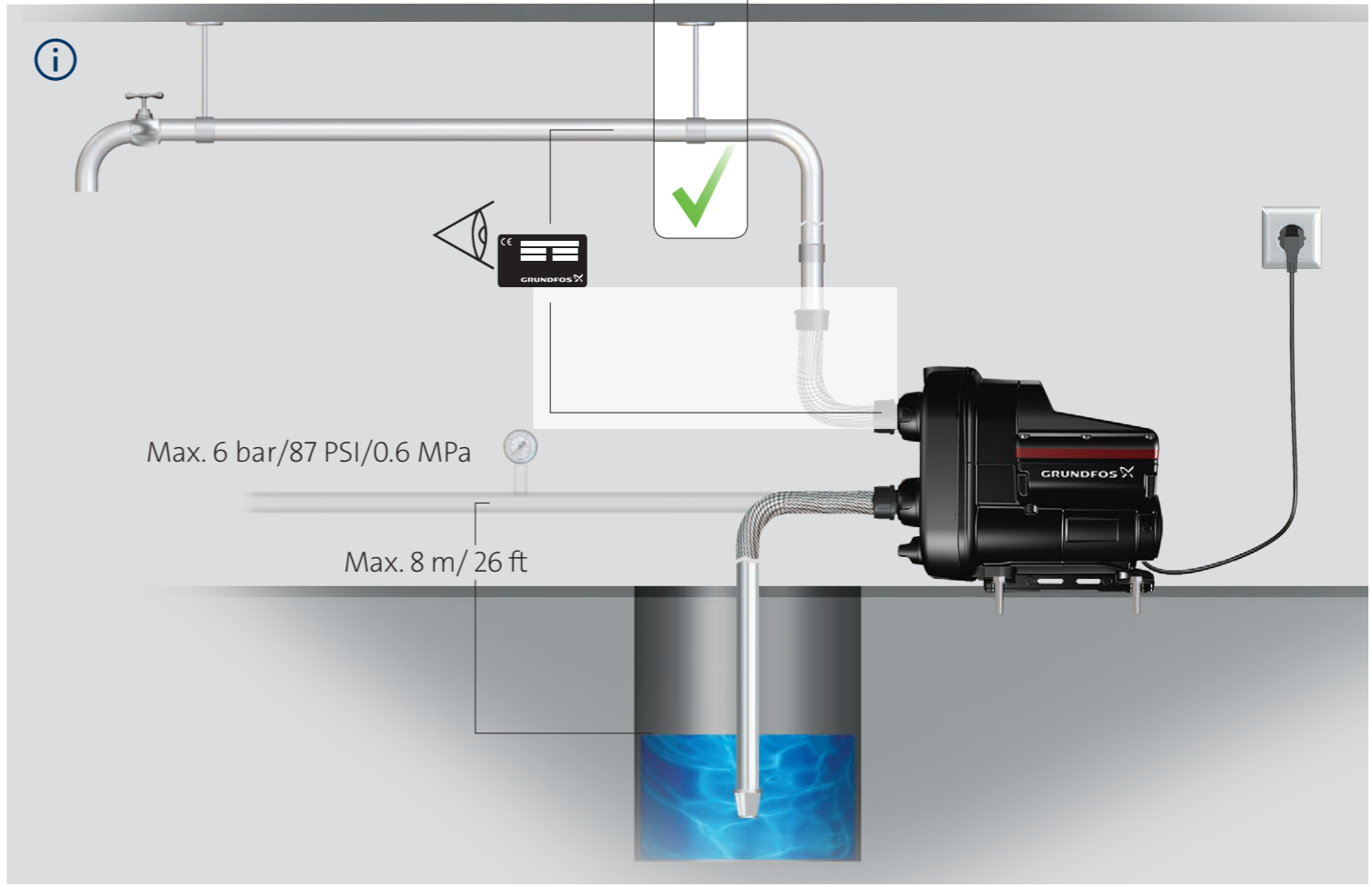

# SCALA2

be  
think  
innovate

**GRUNDFOS** 

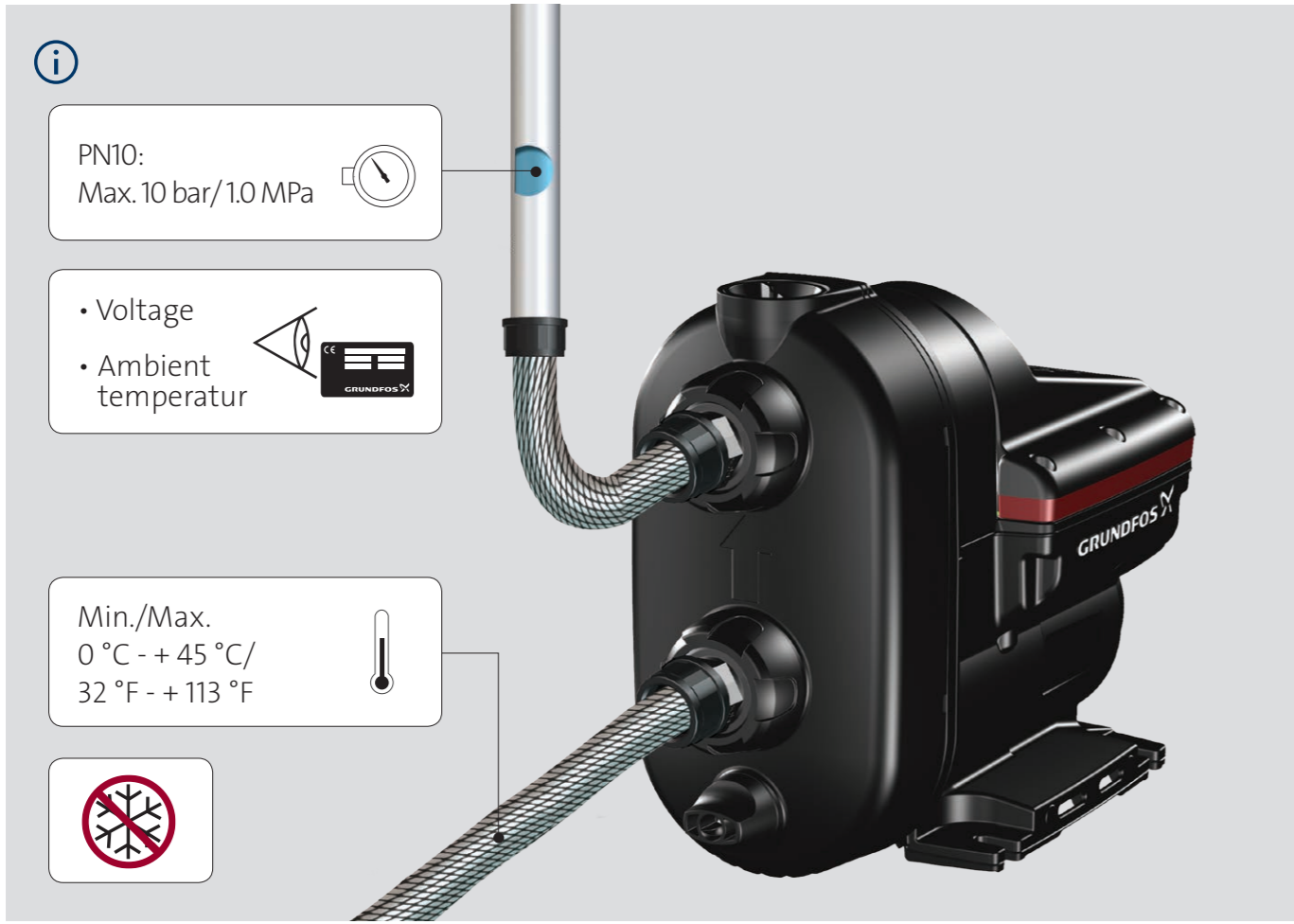
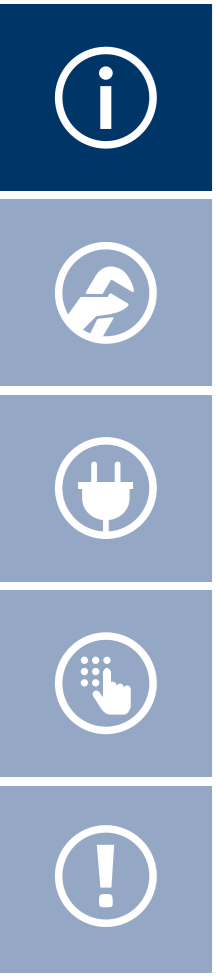

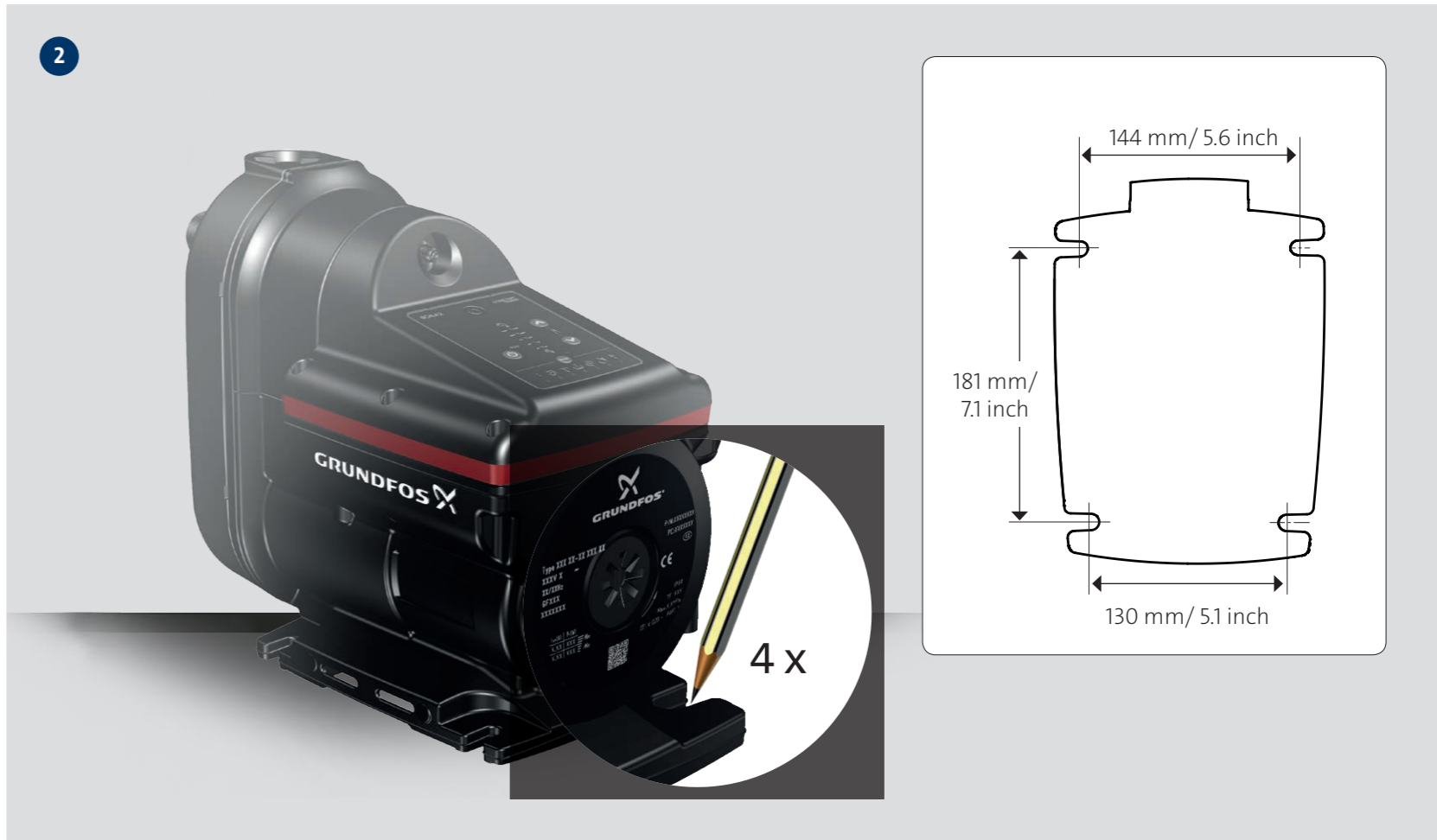
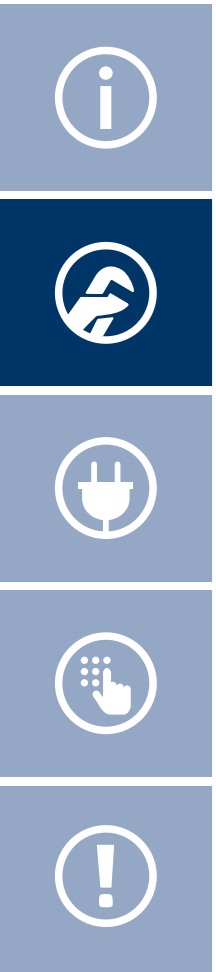



3

4 x

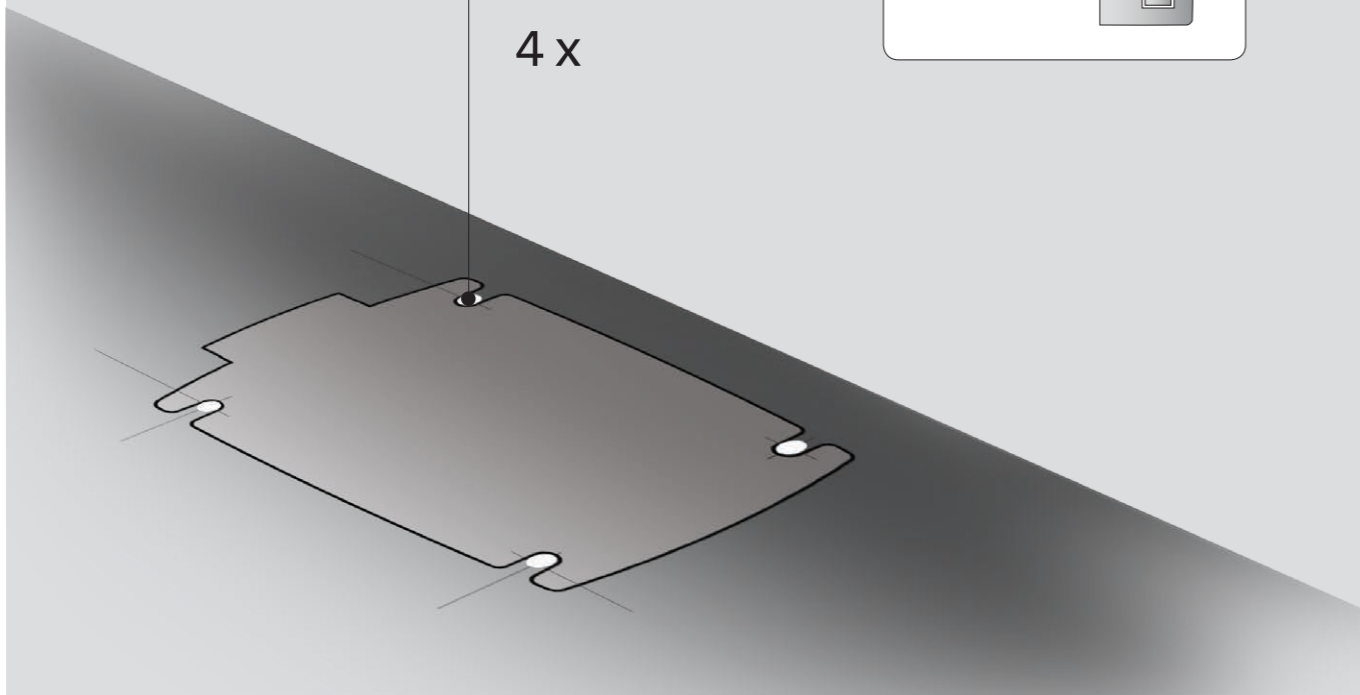
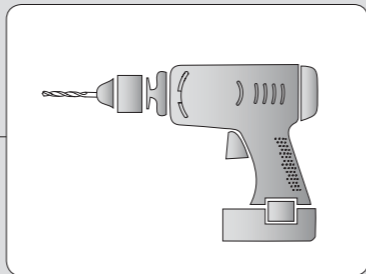

4



4 x

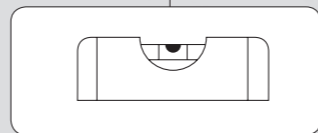

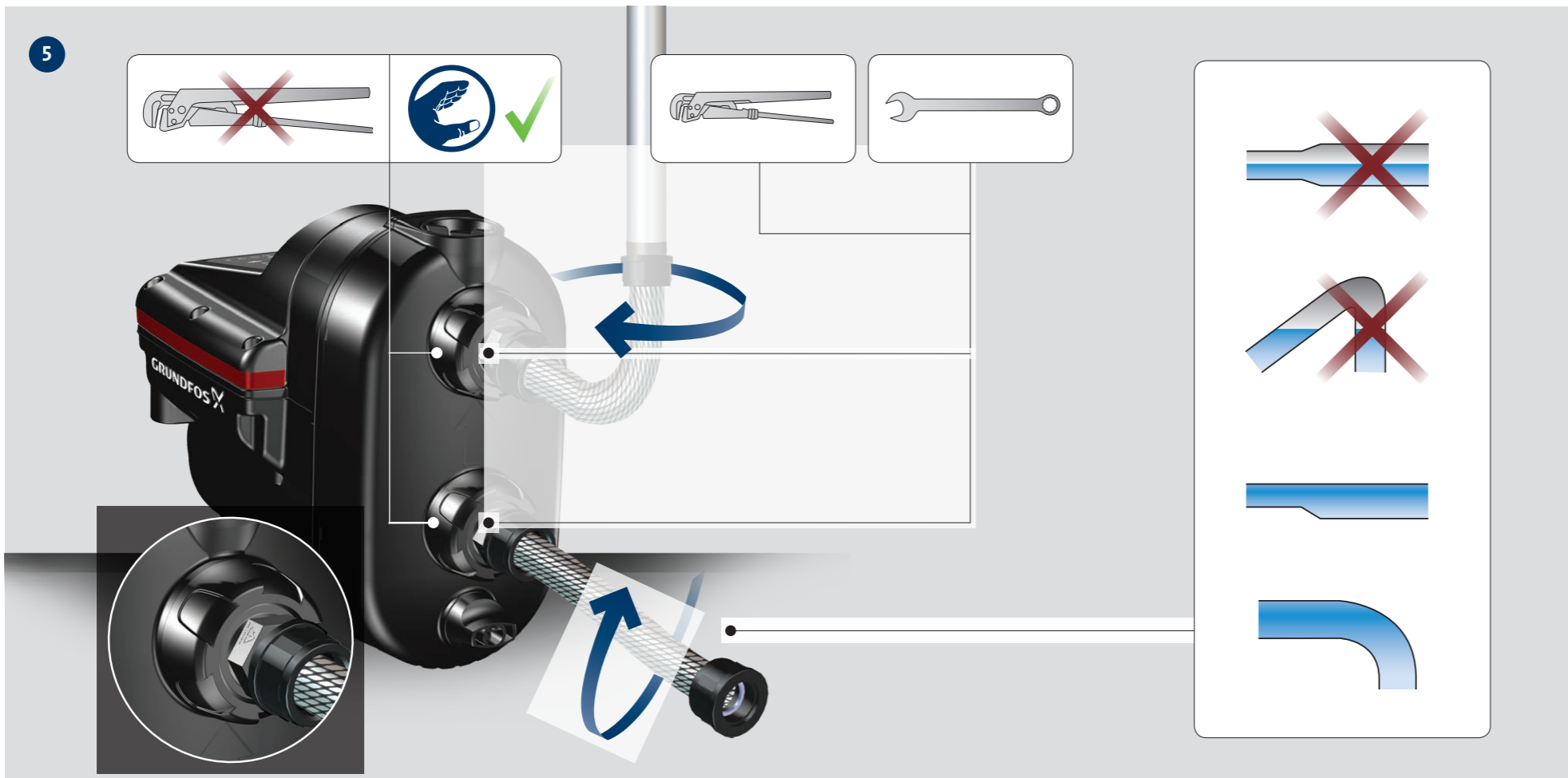
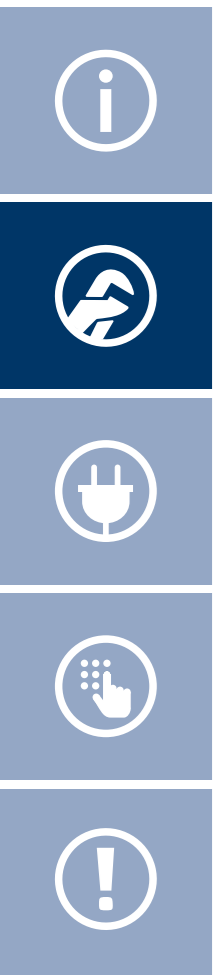

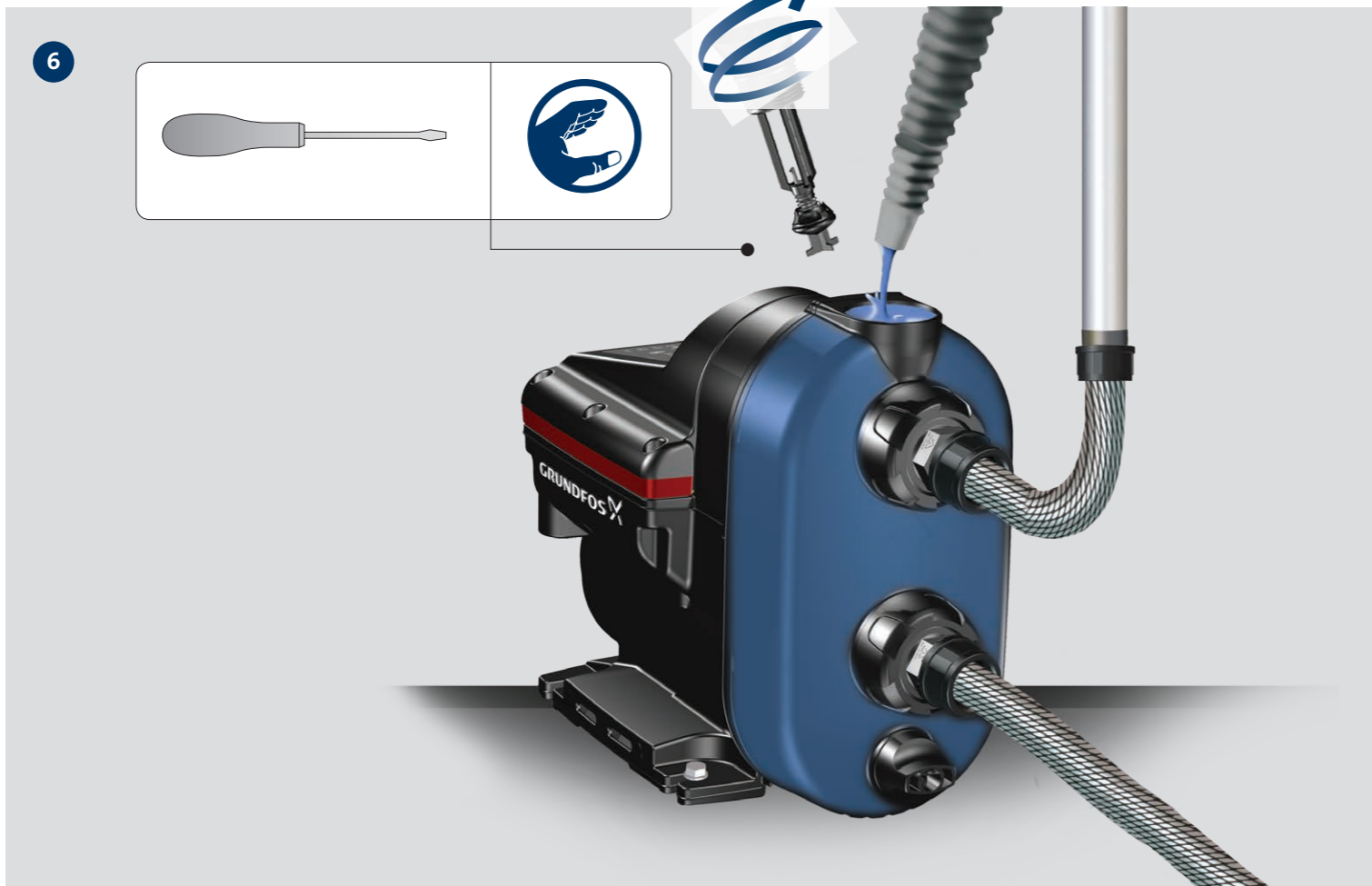
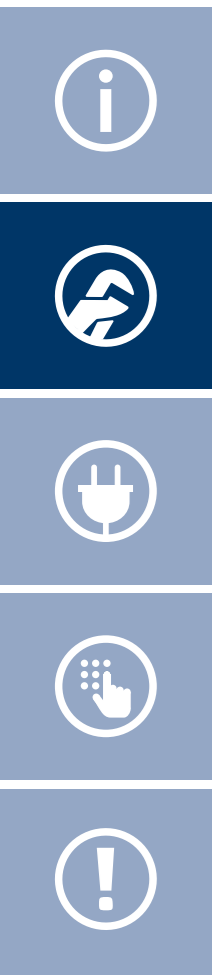

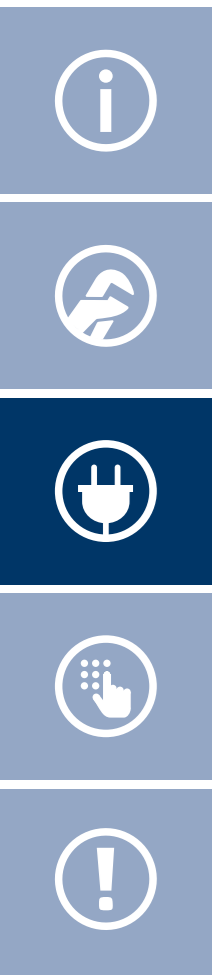

8

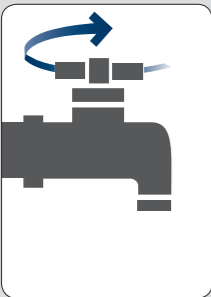

9

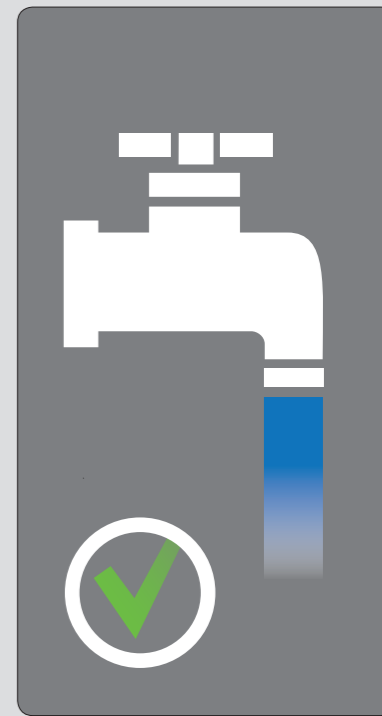

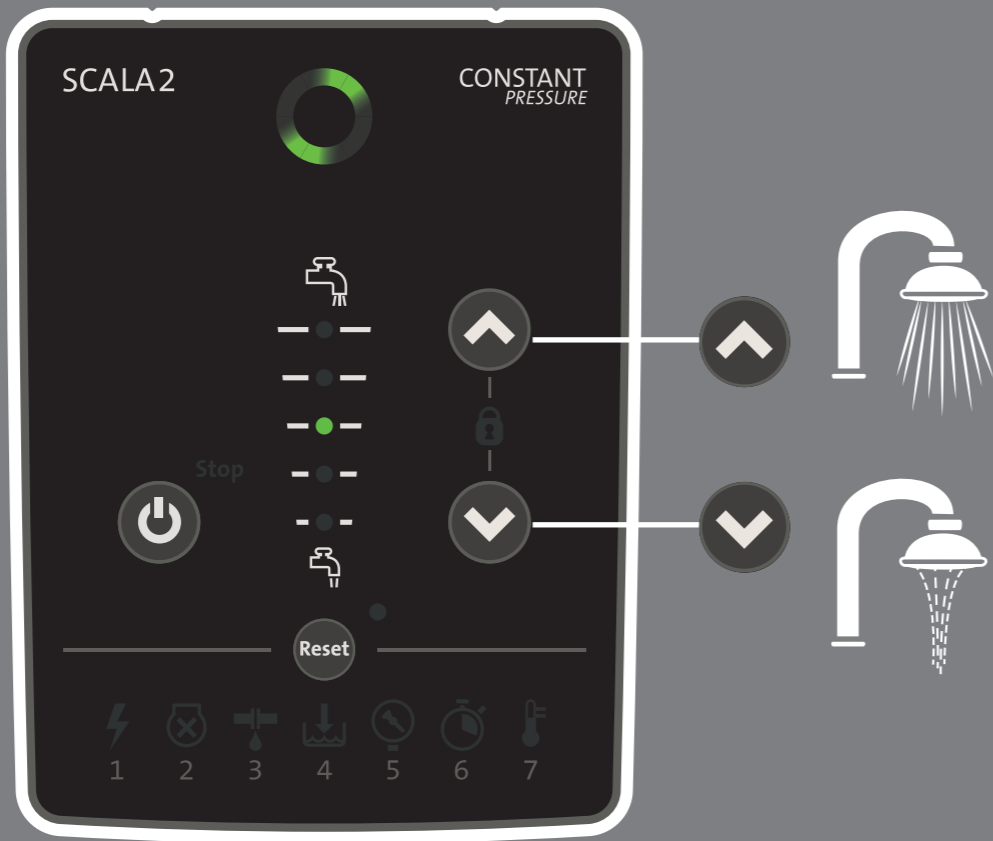
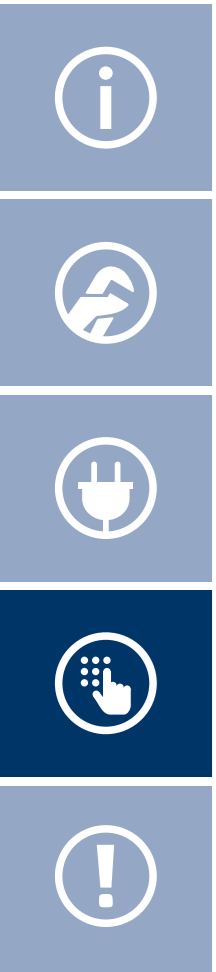



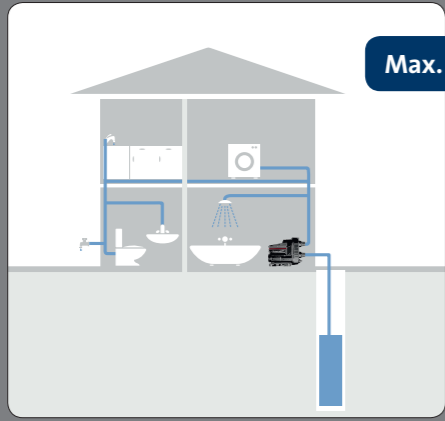
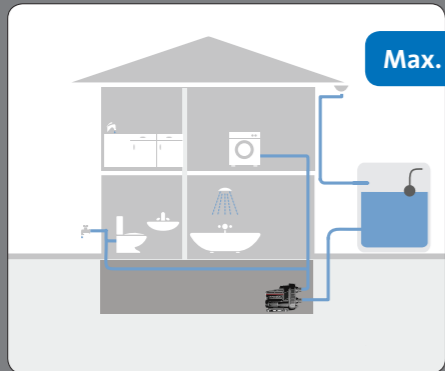
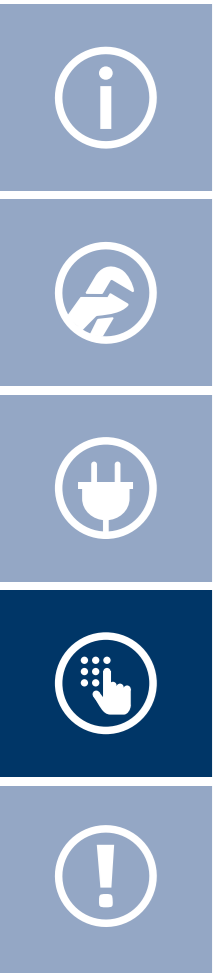

5.5	80	55/180	550	0.55
4.5	65	45/150	450	0.45
3.5	51	35/115	350	0.35
2.5	36	25/80	250	0.25
1.5	22	15/50	150	0.15

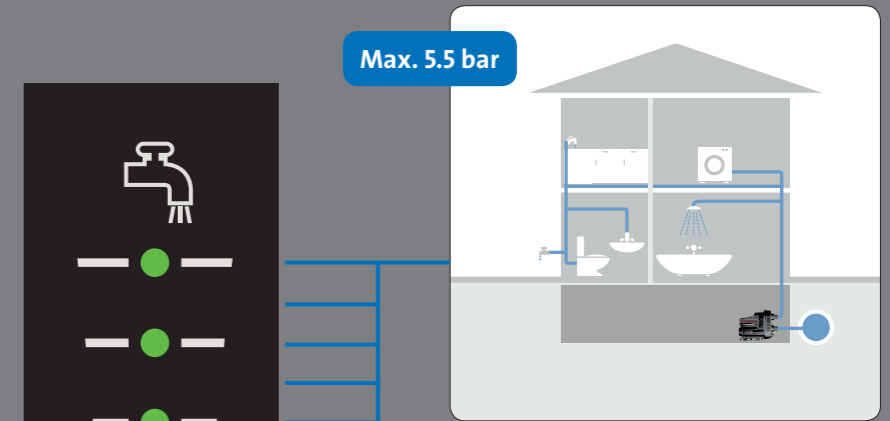

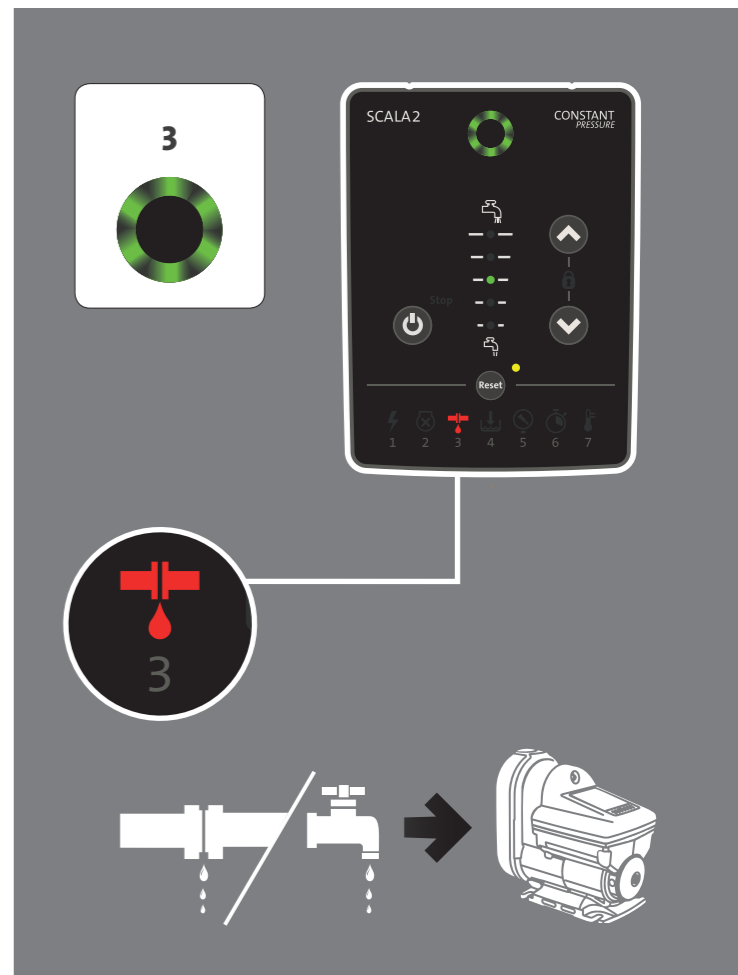
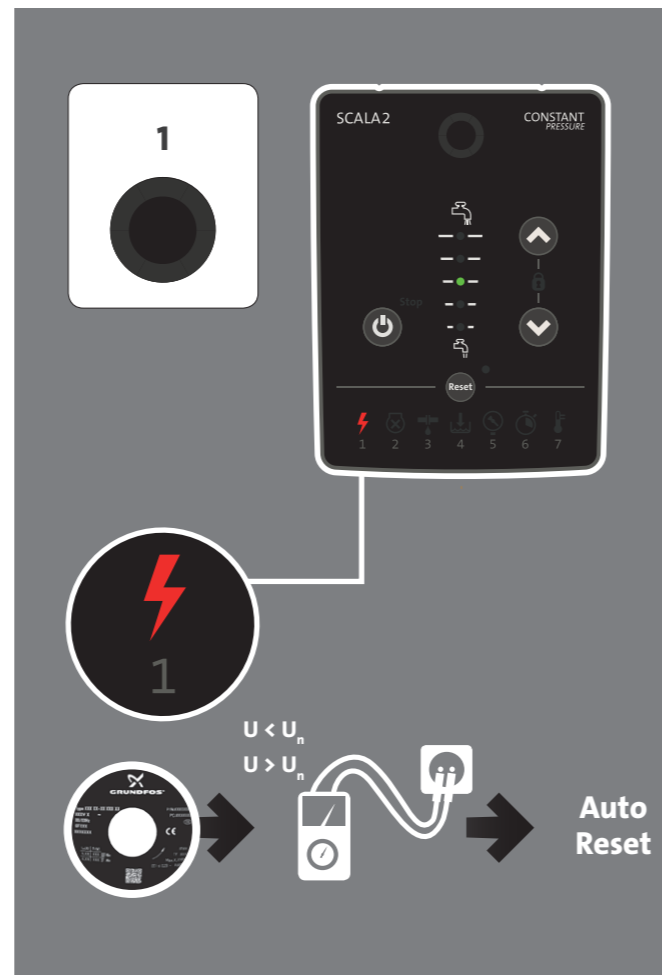
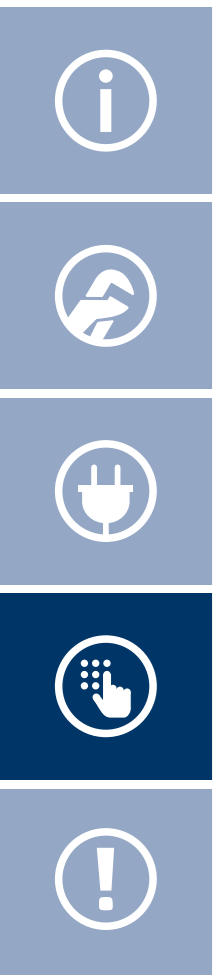

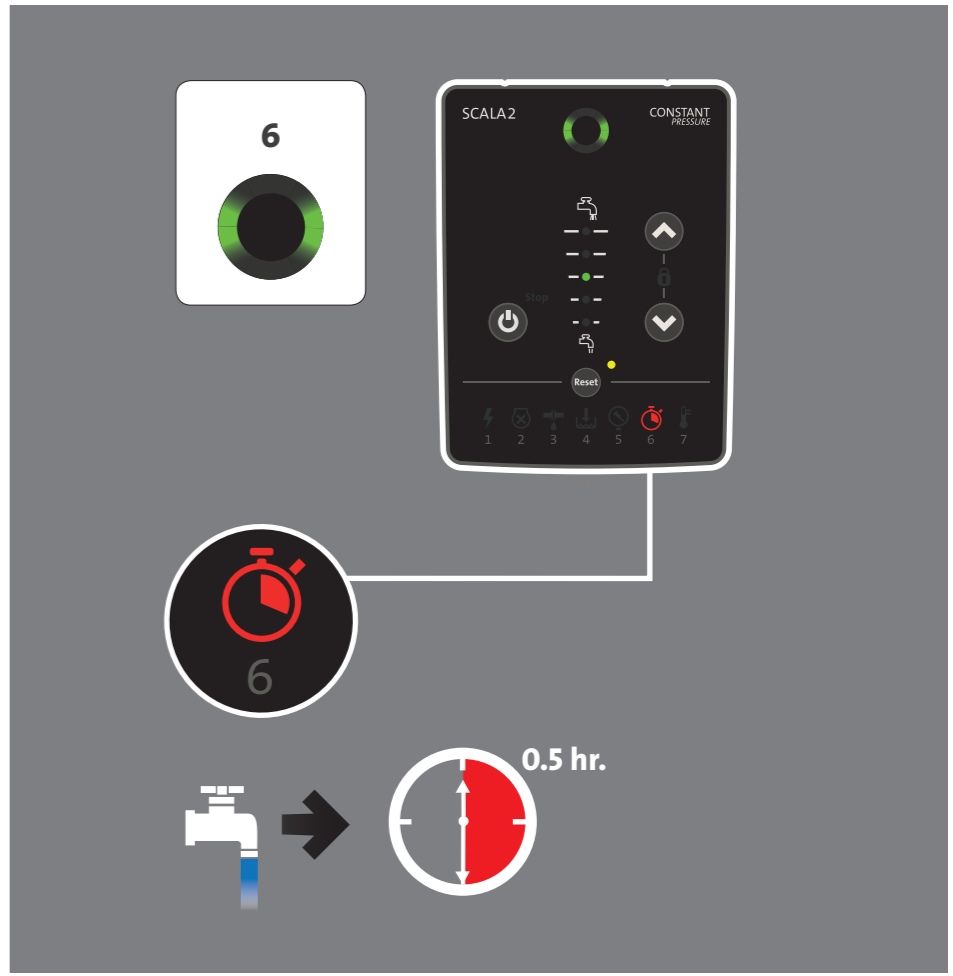
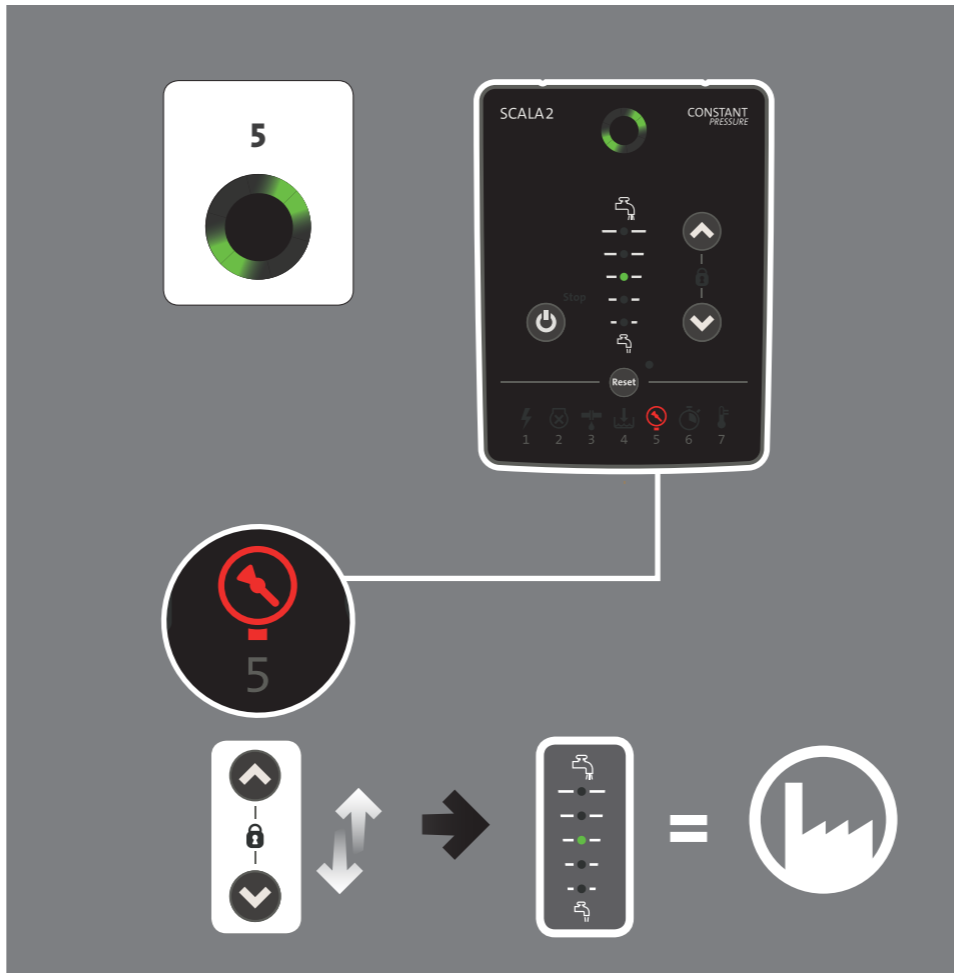
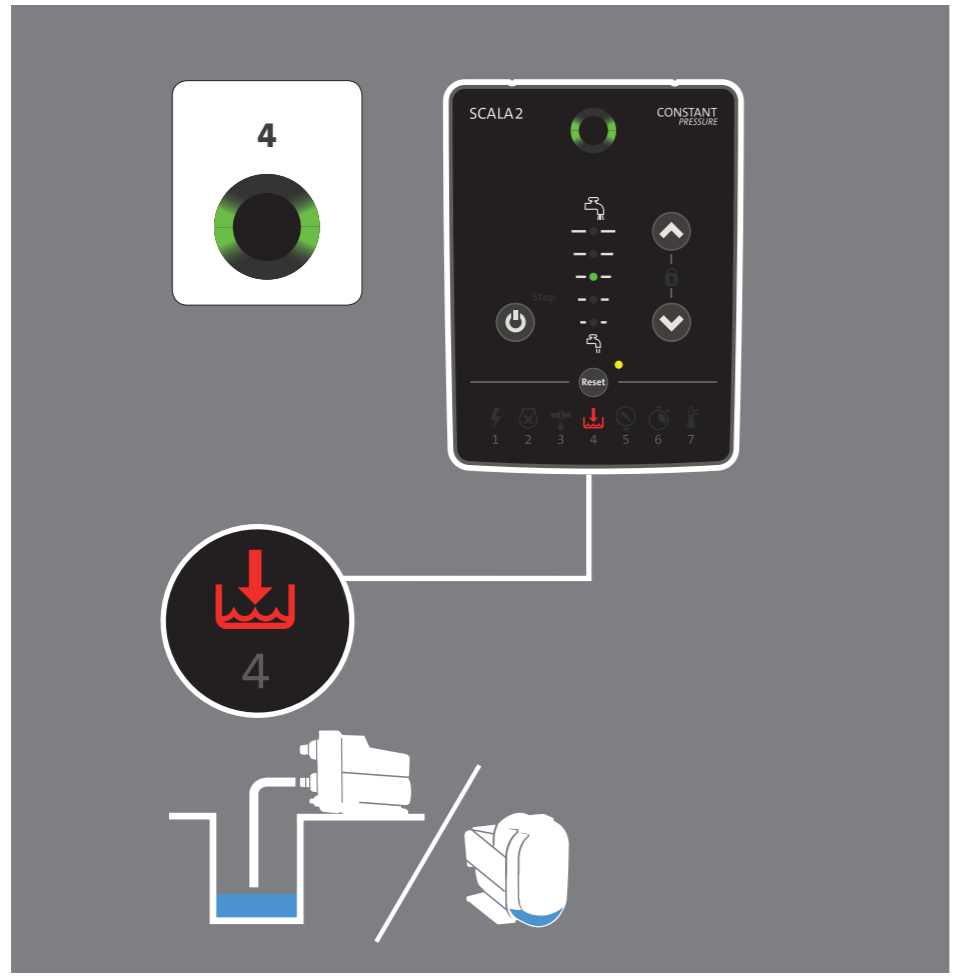
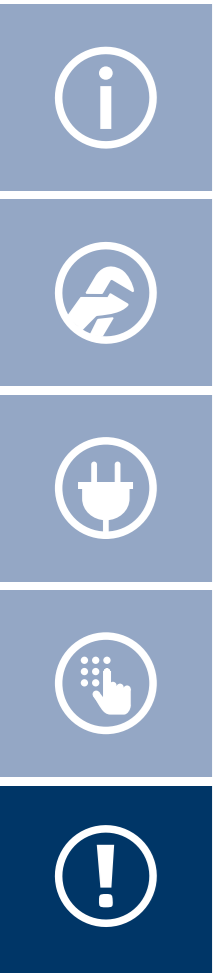

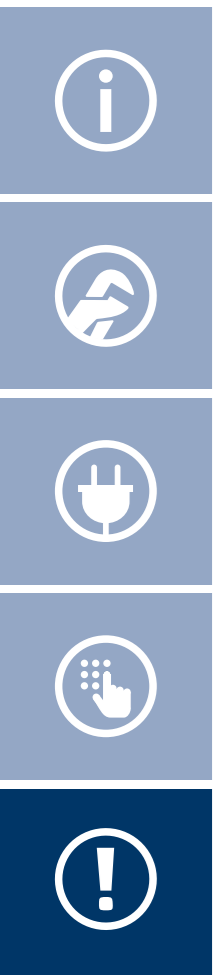

SCALA2 CONSTANT PRESSURE

7

7

Stop

Reset

1 2 3 4 5 6 7



be think innovate

---

**avroa-arm.ru**  
**+7 (495) 956-62-18**

**GRUNDFOS** 