

Kelvion



avroara-arm.ru
+7 (495) 956-62-18

Product Line: Desublimators

**ALWAYS ONE
STEP AHEAD**

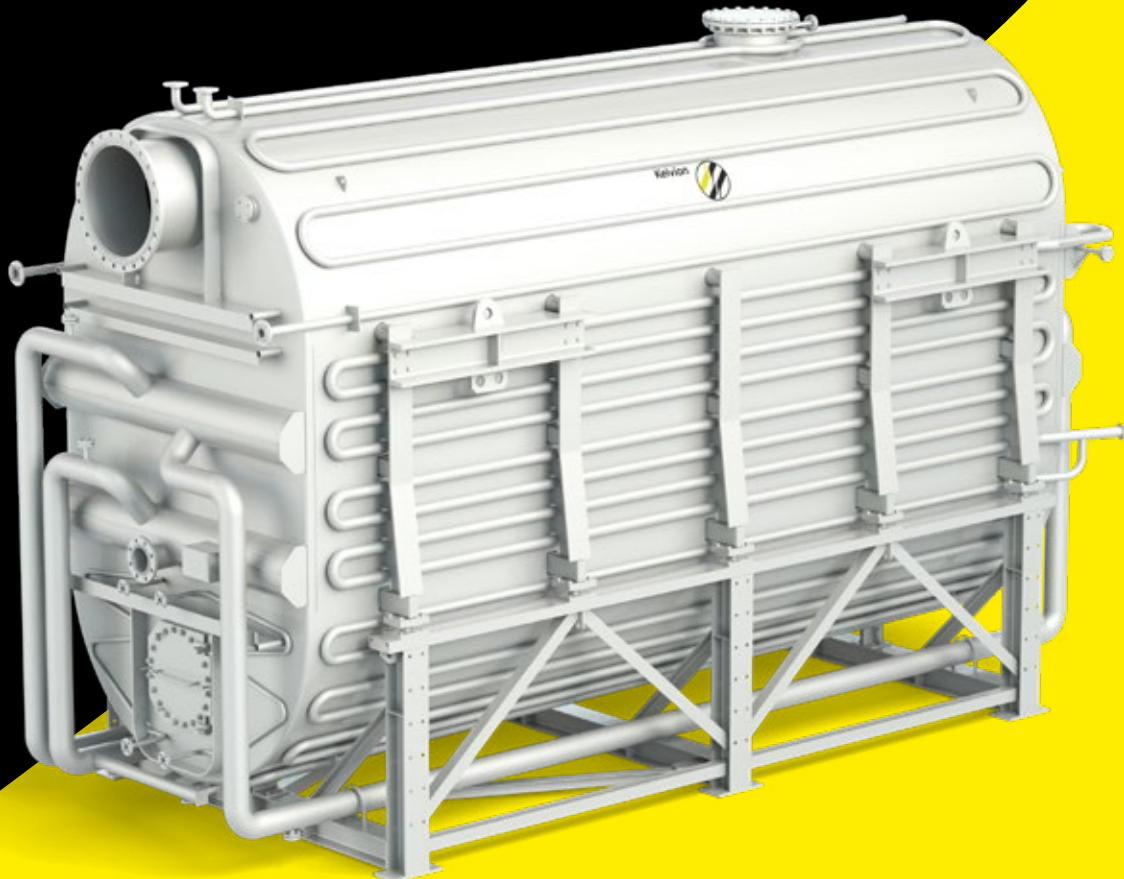

Kelvion



EXPERTS IN HEAT EXCHANGE – SINCE 1920

Welcome to Kelvion! Where Heat Exchange is our Business. We are one of the leading global manufacturers of heat exchangers and have been providing solutions for almost every industrial application imaginable since the 1920s, specializing in customized solutions suitable for extreme environmental conditions - as of 2015 under the name of Kelvion.

With one of the most extensive selections of heat exchangers in the world, we are a well-known partner in many industries, including transportation, energy, oil and gas, the heavy industry, chemical and marine as well as sugar, food and beverage and the HVAC and refrigeration technology sector. Our products include Compact Fin Heat Exchangers, Plate Heat Exchangers, Single Tube Heat Exchangers, Transformer Cooling Systems, Cooling Towers and Shell & Tube Heat Exchangers.

Our many years of experience and in-depth expertise have made us specialists in this field. Our heat exchangers are designed specifically to meet the needs of the respective machine or equipment system, ensuring outstanding energy efficiency and reliability in any market segment. This gives our customers a cutting-edge over their competitors while also reducing operating costs over the long term.

As your heat exchange partner, we understand that outstanding and reliable after-sales services are critical for you, our customer, and we work alongside with you in close partnership supporting you throughout the full life cycle of your plant and equipment to ensure lasting business success.

Kelvion – Experts in Heat Exchange.

KELVION – A TRIBUTE TO LORD KELVIN (1824 - 1907)



Lord Kelvin formulated the laws of thermodynamics and absolute units of temperature are stated in kelvin, in his honor.

OUR LOGO – INSPIRED FROM THE SCHEMATIC FOR HEAT EXCHANGER

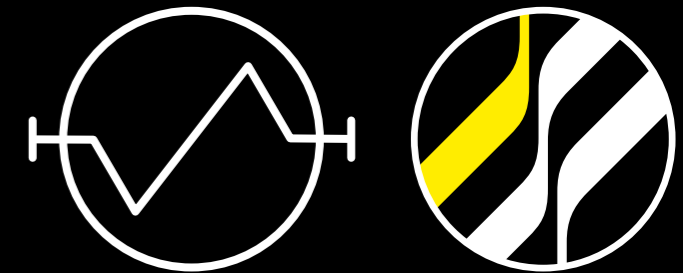

67 BRANCHES AND SALES PARTNERS WORLDWIDE

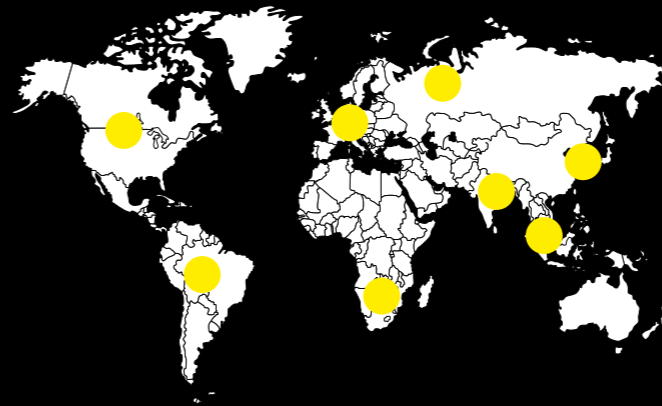

5,000 EMPLOYEES WORLDWIDE

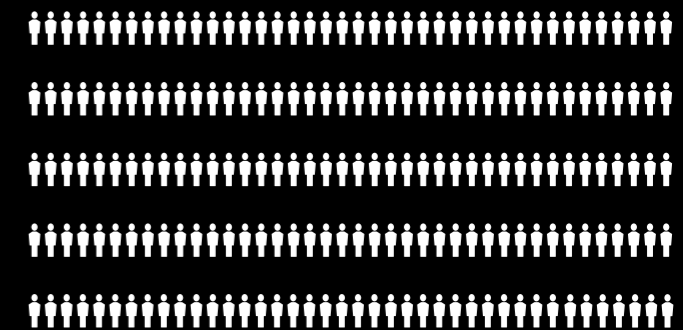

YOUR MARKETS ARE OUR MARKETS

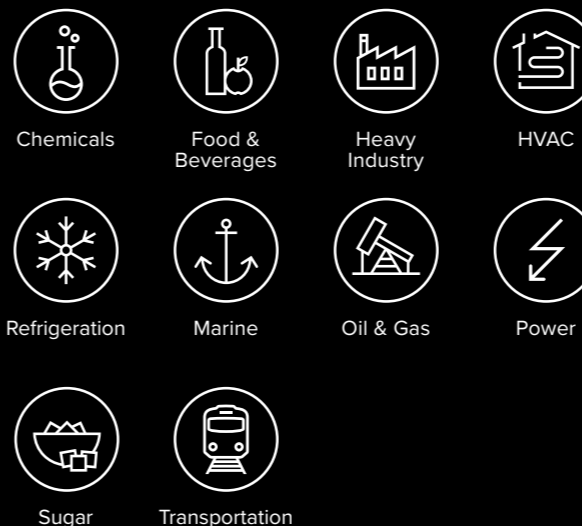

KELVION HAS A LONG HISTORY



We invest in Quality and Sustainability

60 YEARS OF RESEARCH & DEVELOPMENT

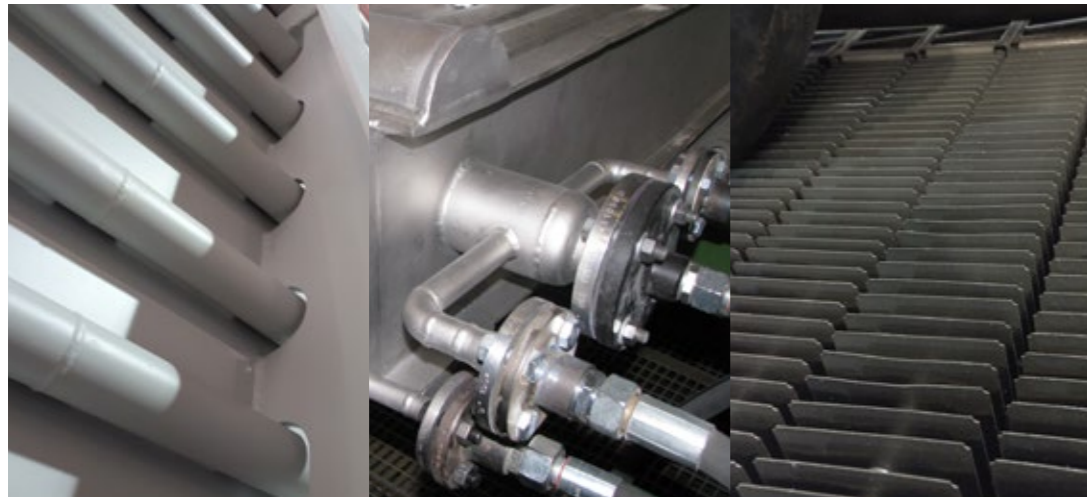

In 1954 Kelvion engineers invented the first desublimator, called the Switch Condenser, for the phthalic anhydride (PA) process. Today the technology can be found in most PA plants around the world.

Over the last 65 years we have continued to refine and further develop our products, in co-operation with our customers, making us the global market leader in desublimation technology.

The latest generation Switch Condenser was introduced in 2012, while Mini Desublimator, our smallest model, has been a popular choice since 1982 for protecting the vacuum system of the distillation in the PA process, as well as many other applications.

Our engineers not only focus on thermodynamics and heat engineering, but also work closely with our customers to provide a desublimator that will integrate fully with their specific process-engineering requirements.

With their intimate knowledge of manufacturing and applications, Kelvion experts analyse production environments and processes. They then develop recommendations and help to implement them. Our approach is holistic, but the solution is specific and individual.

Our extensive manufacturing and welding engineering know-how enables us to offer all weldable materials when designing the unit. Our range of services is rounded off by support during plant start-up and optimisation in day-to-day operation.



KELVION INNOVATIONS

- ▶ Innovation through continuous development in cooperation with universities and institutes
- ▶ Continuous development driven by customers' experiences
- ▶ Optimum use of surface area for highly-efficient product separation
- ▶ Long lifetime due to flexible design for cyclic operation
- ▶ Lighter weight for reducing energy consumption

DESUBLIMATION PRINCIPLE



Desublimation is the direct phase change of a substance from a gas to a solid, without an intermediate liquid state. This phenomenon naturally occurs in the formation of hoarfrost when water vapour from the ambient air freezes on contact with cold surfaces as ice crystals. Frost on the window in winter is a familiar example. Another is the frost formation in home freezers.

Kelvion engineers reproduced this process in a desublimator to separate substances from gas mixtures.

The log p/T diagram shows that desublimation is separate from condensation. Whereas water from the ambient air condenses above the triple point, the water below the triple point can only desublimates from the gas phase. As well as direct desublimation just above the triple point, indirect desublimation is also possible. The result is crystallization, but indirectly via previous condensation. The gaseous substance first condenses, but then freezes immediately on the cold surface – in nature this manifests as freezing rain.

GOOD TO KNOW

- ▶ Desublimators are not “regular” heat exchangers.
- ▶ The purpose of desublimators is material separation through phase change.
- ▶ Desublimation is a thermodynamic material separating process.
- ▶ Desublimation can be an attractive alternative to adsorption, absorption or cyclon separation methods.

DESUBLIMATOR OPERATION

STEP 1

Gas mixture enters the desublimator.



STEP 2

The gas mixture flows through cooled lamellas/fins where the part to be separated desublimates either around or below its triple point, and adheres to the cold surface in crystalline form.

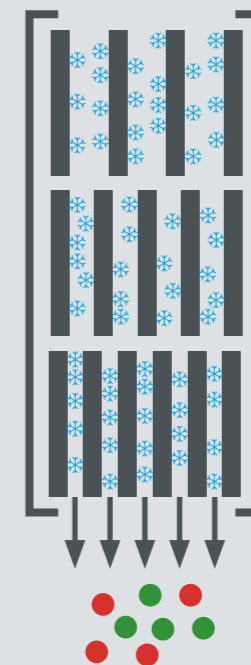

STEP 3

The crystallized product is melted off as soon as the desublimator is fully loaded. Using a minimum of two desublimators allows a continuous process.

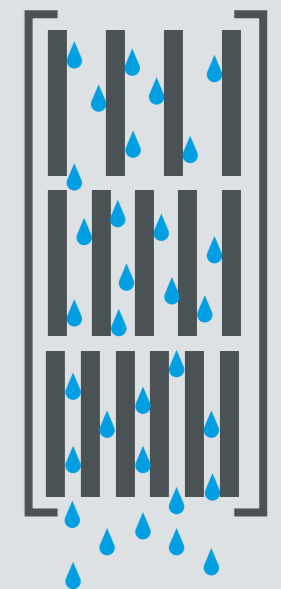

log p / T DIAGRAM: PARTIAL PRESSURE AS FUNCTION OF TEMPERATURE

PHASE CHANGES

- ▶ **Condensation:** phase change above the triple-point e. g. rain, dew formation
- ▶ **Indirect desublimation:** phase change just above the triple-point e. g. freezing rain, freezing moisture on cold surfaces
- ▶ **Direct desublimation:** phase change below the triple-point e. g. snowfall, crystallization on cold surfaces

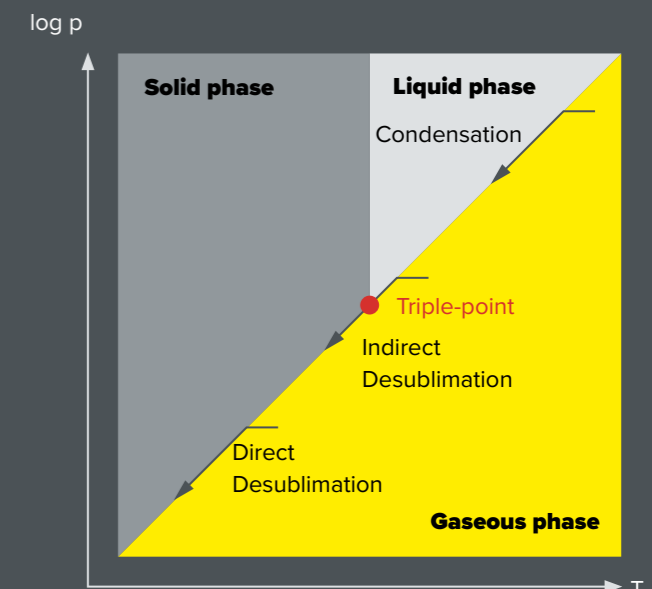

OUR SOLUTIONS

Technical Desublimator

Desublimation is a thermodynamic process for separating product from a gas stream and is an alternative to adsorption and absorption. The separation is achieved by cooling and heating in batch-operation. It is used, for example, in chemical and pharmaceutical processes, to secure vacuum pumps or for tank venting. The separated component can be an invaluable raw material or may be hazardous for the environment.

Kelvion desublimators are available in a range of vessel sizes, materials, certificates and tests to support customer requirements worldwide.

Desublimator Technology

The design philosophy of our desublimators is the optimal use of the entire installed surface for collecting substances. For that reason, we have introduced at least three sections with different designs and functions.

For example, the desublimator for the PA process, called a Switch Condenser has high density, high yield and high efficiency sections. The high density section is located next to the gas inlet to collect PA in a very compact form. The high yield section in the middle of the unit is not only for PA collecting but also for gas cooling. Finally, the high efficiency section next to the gas outlet is designed mainly for gas cooling. In addition, it has a special filter function for PA needles, which guarantees the very high efficiency of our Switch Condensers.

While the Switch Condenser is a tailor-made solution for the PA process, the Mini Desublimator is well established for many other applications, using the same design philosophy.

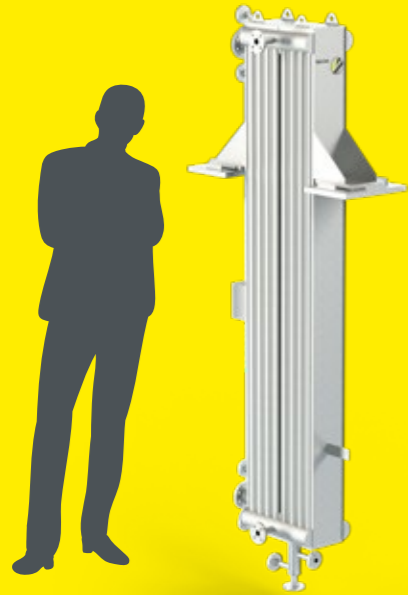

Mini Desublimator

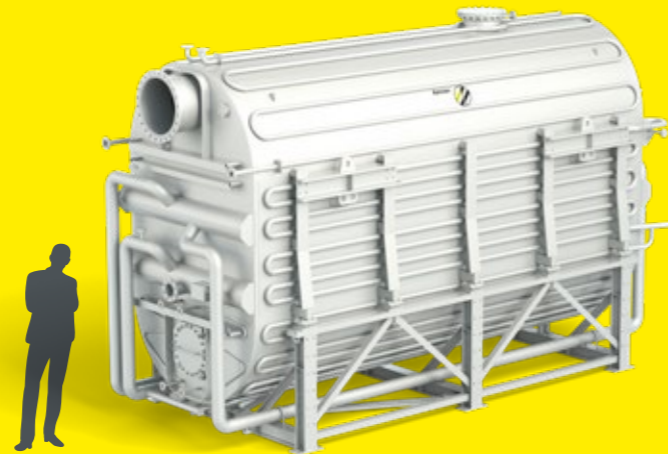

Switch Condenser

WHY TO USE KELVION DESUBLIMATORS



Highest separation efficiency of components from gas-streams at optimum product purity.



Low energy consumption achieved through optimized equipment design

Highest ecological compatibility by avoiding solvents



Innovative and advanced product due to our co-operation with international universities and institutes, as well as with industries

EFFICIENCY OF...

... POWER PLANTS



40 - 45 %

... HEAT EXCHANGERS



approx. 80 %

... FILTERS / DEMISTERS



approx. 98 %

... DESUBLIMATORS

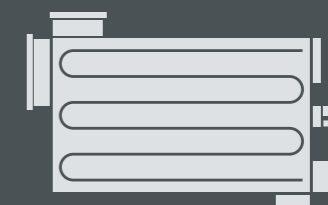

approx. 99.5 %

Mini Desublimator

THE BIG SMALL



In the Mini Desublimator unit the gas mixture comes into contact with cooled lamella/fins. Here that part of the gas mixture to be separated desublimates either around or below its triple point and adheres to the cold surface in crystalline form. The Mini Desublimator unit is split into several sections to achieve an optimum distribution of the product inside the desublimator. This special design feature ensures the highest separation efficiencies and longest loading times.

A range of lamella/fin designs are available for optimum utilization of the heat exchanger surface – and the sectors are adapted individually to each process requirement to achieve superior separation efficiency of over 99.5 percent. The crystalized product is melted off as soon as the desublimator is fully loaded. The heating medium flows through the same channels as the cooling medium. A continuous process is achieved by using a minimum of two Mini Desublimators.

Mini Desublimator comes in standard sizes, as well as a wide range of tailored design configurations and internal fittings. Thanks to its compact design the unit does not take up too much space. Mini Desublimator is available in all weldable materials. For operational safety and to reduce the risk of leaks, there is no direct welding between the gas and cooling/heating sides. Also, the number of welds is minimized. Design, manufacturing and testing to the highest international standards prove Mini Desublimator's reliability.

BENEFITS

- ▶ Clean process: no chemicals or water needed
- ▶ Excellent separation efficiency of 99.5 %
- ▶ High product purity
- ▶ Minimal space requirements due to compact design
- ▶ No moving parts: low wear, high operational reliability, virtually maintenance-free
- ▶ Low energy consumption

DESIGN DATA



DESIGN PRESSURE

- ▶ VACUUM UP TO 50 BAR



GAS FLOW

- ▶ 5 - 500 KG / H



DESIGN TEMPERATURE

- ▶ -150 °C TO 350°C

Applications



Product separation in chemical & pharmaceutical processes



Environmental protection

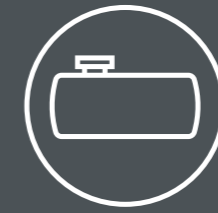

Tank venting



Protection of vacuum systems



Recovery of valuable (raw) materials

Typical substances that can be separated by desublimation:

AMINOPHENOL
Water Oligomers
PHTHALIC ANHYDRIDE
Polylactide NAPHTHALENE
Chloro aniline
Polymers IODINE
Naphthol TDA (diamino toluene)
GLYCOLIDE Amylphenol



INTERNATIONAL CERTIFICATION

- ▶ TÜV NORD
- ▶ TÜV Rhineland
- ▶ TÜV Austria
- ▶ Det Norske Veritas
- ▶ Class NK
- ▶ Lloyd's Register of Shipping
- ▶ Bureau Veritas
- ▶ American Bureau of Shipping
- ▶ Germanischer Lloyd
- ▶ Urząd Dozoru Technicznego
- ▶ Inspection and Quarantine of the PRCh
- ▶ Gost – RT
- ▶ U-Stamp acc. ASME Code

POSSIBLE APPLICATIONS



Desublimation offers the following advantages over other substance separation processes, such as washing with solvents:

- ▶ low operational cost
- ▶ environmentally friendly
- ▶ no solvents to be disposed of
- ▶ high product purity
- ▶ high separation rates

Product separation in processes

When the PA process was established in 1954, in co-operation with chemical and pharmaceutical industry pioneers, Kelvion provided valuable support with the launch of its first desublimators. Since then, our thermodynamic separation technology has provided a reliable alternative, with significant advantages, to the traditional separation methods of adsorption, absorption and cyclones.

In the PA process ambient air is enriched with a feedstock, which reacts to generate the PA. This is then separated from the reaction gas stream and used commercially as an industrial chemical and raw material.

The Kelvion desublimators can handle large amounts of gas and therefore separate a significant amount of PA – at the highest efficiency in the industry of 99.5% minimum. Today the PA process remains the main application for our desublimators in the chemical industry, which are installed in most PA plants worldwide.

In recent years we have successfully introduced this technology into other processes. For a continuous process at least two desublimators have to be installed. The PA process commonly requires four desublimators per production line.

Environmental protection and tank venting

Another application for the Kelvion desublimator is cleaning polluted waste gas streams, for example, venting of industrial fuel or storage tanks. The vent gases leave the tanks as a mixture of inert gas saturated with the stored substance. The desublimator acts as a vent cooler to reduce the amount of substances that can be desublimated escaping into the environment. The waste gas is reliably cleaned in the desublimator by separating the substance enriched in the inert gas. In this application it is generally sufficient to install only one desublimator directly on top of the tank.

Recovery of valuable (raw) materials

In the chemical and pharmaceutical industries it is not unusual for valuable raw materials to be found in the production process. These may only be required as reaction intermediates, not for inclusion in the end product.

An example of this is iodine, which is a very expensive halogen. Iodine contained in gaseous substance streams desublimates even at room temperature. When used as an intermediate, it can be easily recovered in Kelvion desublimators.

In the production of polyphenylene sulfide (PPS) several desublimators are installed in certain process steps to separate the valuable iodine. Using desublimators, iodine can be almost completely recovered, making the continuous production process of PPS economically viable.

Protection of vacuum systems

A problem encountered in process engineering is when the vacuum generator draws in substances contained in the suction stream. These can desublime in the inner part of the generator, causing blockages. To avoid this, desublimators can be used to clean the substances from the suction stream.

For example, in vacuum distillation two desublimators will clean the saturated suction gas from the distillation section. In this way, a continuous and safe process is guaranteed.

Switch Condenser

THINK BIG



Since the invention of the Switch Condenser in 1954, Kelvion has delivered more than 1,500 units globally for PA processes. We have continuously developed the mechanical as well as the process design of our Switch Condensers. In particular, we have adapted the specially designed fin tube system of rectangular fins to meet the latest PA process requirement of increasing feedstock loading of the air.

The design philosophy behind our Switch Condensers is the optimal use of the entire surface for collecting PA, to ensure economical loading times. For that reason, we have introduced three sections of fin tube systems with different designs and functions.

The main task of the high density section is collecting PA in a very compact form. Next, there is a high yield section, which also collects PA and cools gas. Finally, the high efficiency section has a special filter function for PA needles. This guarantees the very high efficiency rate of Kelvion switch condensers.

Our engineering excellence has convinced our customers worldwide, who have confirmed our technological advantages in their processes and daily operation. As a result, Kelvion is the undisputed world market leader in desublimator technology.

Based on our extensive knowledge of the PA process, Kelvion engineers have developed further valuable solutions for this process. In particular, the GasKat (postreactor) and Precondenser (partial PA condenser), both of which are standard in a modern PA plant.

DESIGN DATA



GAS FLOW

▶ MAX. 40,000 NM³/H



CAPACITY

▶ MAX. 10,000 KG PA/CYCLE



EFFICIENCY

▶ MIN. 99.5 %



O-XYLENE LOADING

▶ 100 G/NM³ AIR & HIGHER

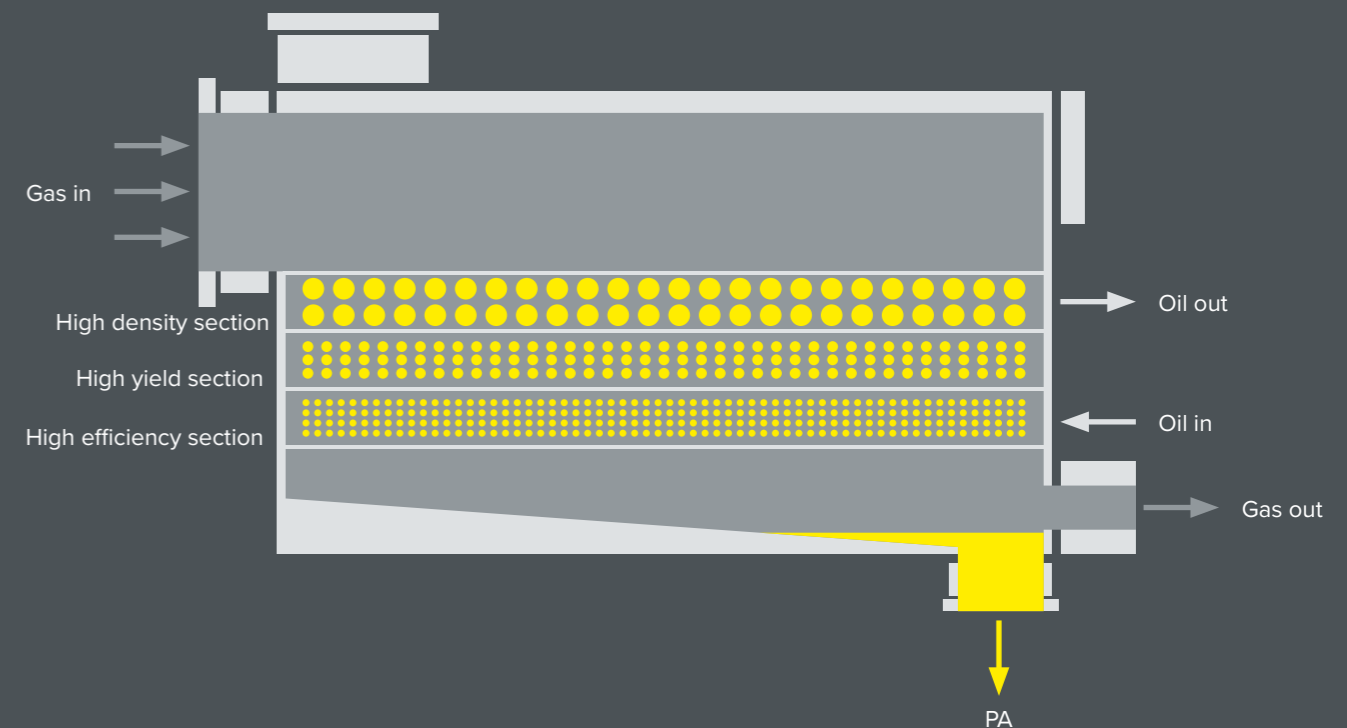

BENEFITS

- ▶ Highest efficiency/minimum PA loss
- ▶ Low weight
- ▶ Low operating cost
- ▶ Low energy consumption
- ▶ High reliability
- ▶ Minimized risk of fatigue failures
- ▶ Long lifetime
- ▶ Maintenance friendly

PHTHALIC ANHYDRIDE PRODUCTION

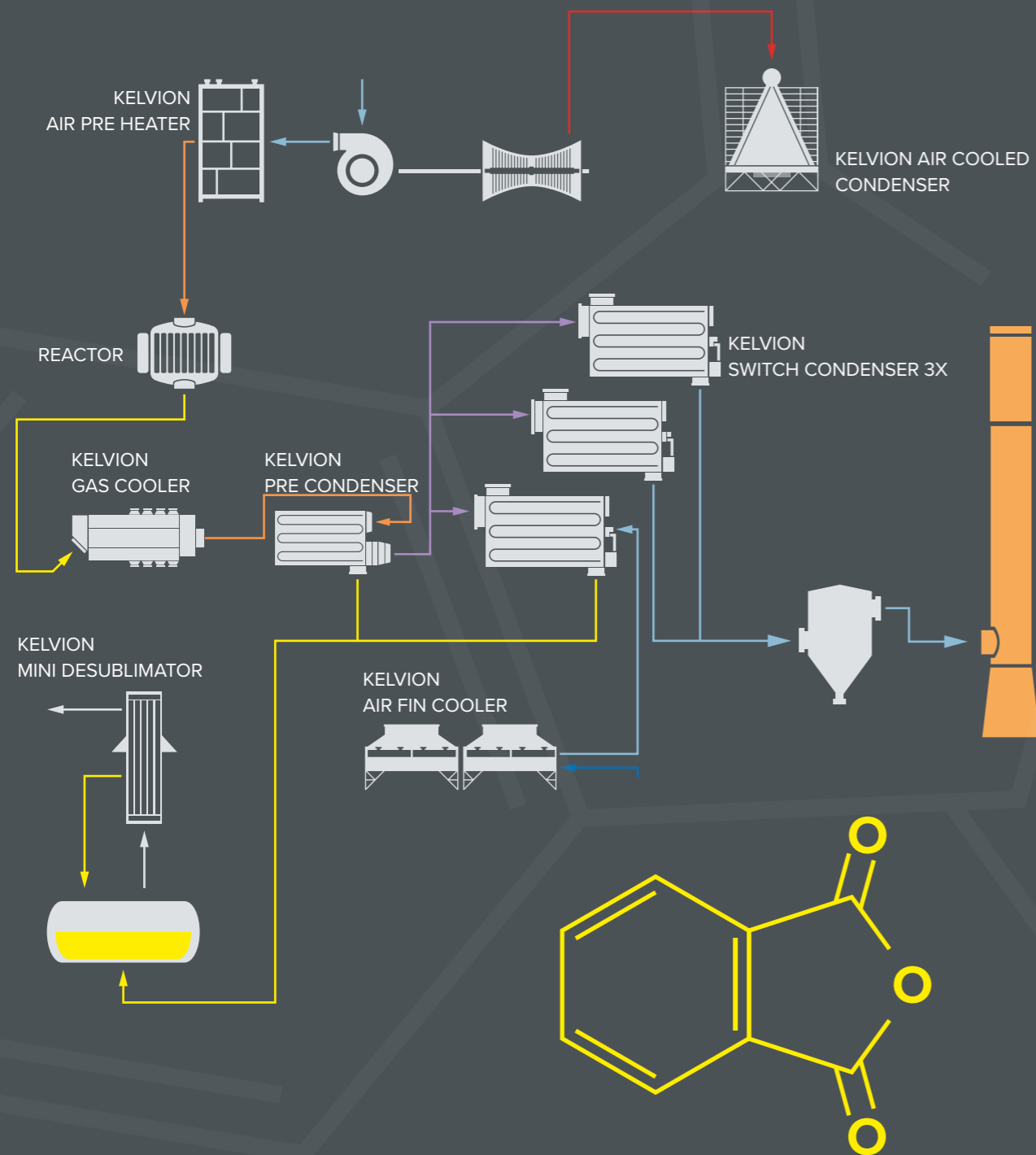

Phthalic anhydride is an important industrial chemical and raw material for manufacturing plasticizers for plastics, resins and polyols, among others. It was the first anhydride of a dicarboxylic acid to be used commercially.

In the PA process, o-Xylene or naphthalene are oxidized in a catalytic reaction to form phthalic anhydride. Besides the Switch Condenser, two other Kelvion technologies are an established part of the process:

- ▶ the gas stream is cooled down in the Kelvion safety gas cooler with or without integrated postreactor, the Kelvion GasKat,
- ▶ the PA is separated from the reaction gas in Kelvion's PA separation system, which consists of the Kelvion precondenser (where PA condenses in liquid form) and normally four Switch Condensers (where PA desublimates in solid form).

KELVION SOLUTIONS EXPLAINED

SWITCH CONDENSER

The Kelvion Switch Condenser is an essential part of any PA plant. Its special process and mechanical design guarantees the highest separation efficiency and a long operational lifetime. Because of its relatively low weight, Kelvion's SWC is low on energy consumption.



SAFETY GAS COOLER/ GASKAT

Downstream of the reactor, the gas must be cooled down to allow the separation of PA. The Kelvion GasKat, which combines a safety gas cooler with a post-reactor in one casing, is the ideal solution. The gas is cooled by the combination of superheating the steam, water evaporation and/or heating of boiler feed-water. GasKat has removable bundles (screwed into the casing) for easy maintenance and laser welded fins – no added materials to the welding seam. The use of finned tubes provides a very compact unit.



PRE CONDENSER

Kelvion developed the Pre-condenser in 1990 specifically to enable the continuous separation of PA in high loading PA-plants, where concentrations are way above the triple point. The Pre Condenser separates the PA from the gas in liquid form, before the gas enters the Switch Condensers.



MINI DESUBLIMATOR

The Mini Desublimator has two main applications in the PA process. Firstly, in distilling the crude PA, where vacuum is required. The Mini-Desublimator protects the vacuum generator against blockages in the vacuum system. The second application is for venting tanks of PA or naphthalene.



AIR PREHEATER

The Kelvion Air Pre-heater plays an important role in heating the ambient air to approximately 200°C, to allow the reaction to take place. This safety finned-tube heat exchanger is a compact unit. It comes with removable bundles (screwed into the casing) for easy maintenance.



AIR FIN COOLER (AFC)

The Switch Condenser requires a cold oil circuit to operate effectively. The oil has to be re-cooled downstream to keep it at the correct temperature. An Air Fin Cooler is the tried and tested technology for this task.



AIR COOLED CONDENSER (ACC)

The PA process is highly exothermic. In many high-loading PA plants, this surplus of energy is used for power generation in a turbine. For condensing the steam downstream of the turbine, Kelvion offers Air Cooled Condensers.



OUR SERVICE IN THREE WORDS: PEACE OF MIND



START-UP SERVICES

We ensure that our products are delivered safely and are fully validated to give a robust and reliable performance over as long a life cycle as possible.

- ▶ Design, manufacturing, delivery, erection, commissioning of revamped Desublimator
- ▶ Supervision of construction on site
- ▶ Commissioning assistance
- ▶ Assistance to erection sub-contractor



SPARE PARTS AND SPARE PARTS SOLUTIONS

Even the best equipment shows signs of wear over time. We use only the highest quality spare parts, designed to match the excellence of the originals. This ensures that the optimum interaction between components is maintained. By safeguarding the original design we offer maximum security of your investment.

- ▶ Spare bundles
- ▶ Spare finned tubes
- ▶ Spare Gaskets
- ▶ Spare Rupture Discs
- ▶ Spare Bellows
- ▶ Spare parts



TESTING AND MONITORING

Having an understanding of the condition of the equipment allows you to secure reliable production, improve safety and energy efficiency and increase equipment lifetime. It can also help you to prevent breakdowns and prepare for the future.

- ▶ CFD modelling
- ▶ Process temperature analysis for:
 - ▶ Gas inlet
 - ▶ Gas outlet
 - ▶ Oil inlet
 - ▶ Oil outlet
 - ▶ Cycle times



UPGRADES AND REPLACEMENTS

We replace components to keep our Desublimators running smoothly and to prevent downtime. Where parts have become obsolete, we will suggest an upgrade.

- ▶ Bundle repair
- ▶ Casing revamp
- ▶ Revamp process design
 - ▶ Postreactor revamp
 - ▶ Desublimator revamp



REPAIRS AND OVERHAULS

We understand that unscheduled downtime can be disastrous. That is why our trained engineers are ready to respond quickly in an emergency. We will review and repair components while keeping any disruption to a minimum. Any overhaul work is carried out in our service centers and conforms to the highest quality standards.

- ▶ Supervisor
- ▶ Site works
- ▶ Repairs



INSPECTIONS AND MAINTENANCE

Through regular inspections and maintenance, we help you to reduce costs, extend the lifetime of all your Kelvion products and to achieve a reliable performance. This also helps you with budget planning.

- ▶ Preventive Inspections
 - ▶ Oil leaks
 - ▶ Gas leaks
 - ▶ Bent tubes
 - ▶ Deposits
- ▶ Corrosion analysis of fins



CONSULTING AND TRAINING

Would you like a consultancy service that takes into account the special features of your process and were you feel that finding the right solutions are more important than closing the deal quickly? Then you will feel right at home with Kelvion. We will work closely with you to develop the exact solution that is best tailored to your needs.

- ▶ Site training
- ▶ Analysis of operating data
- ▶ Optimizing of general performance
- ▶ Failure analysis

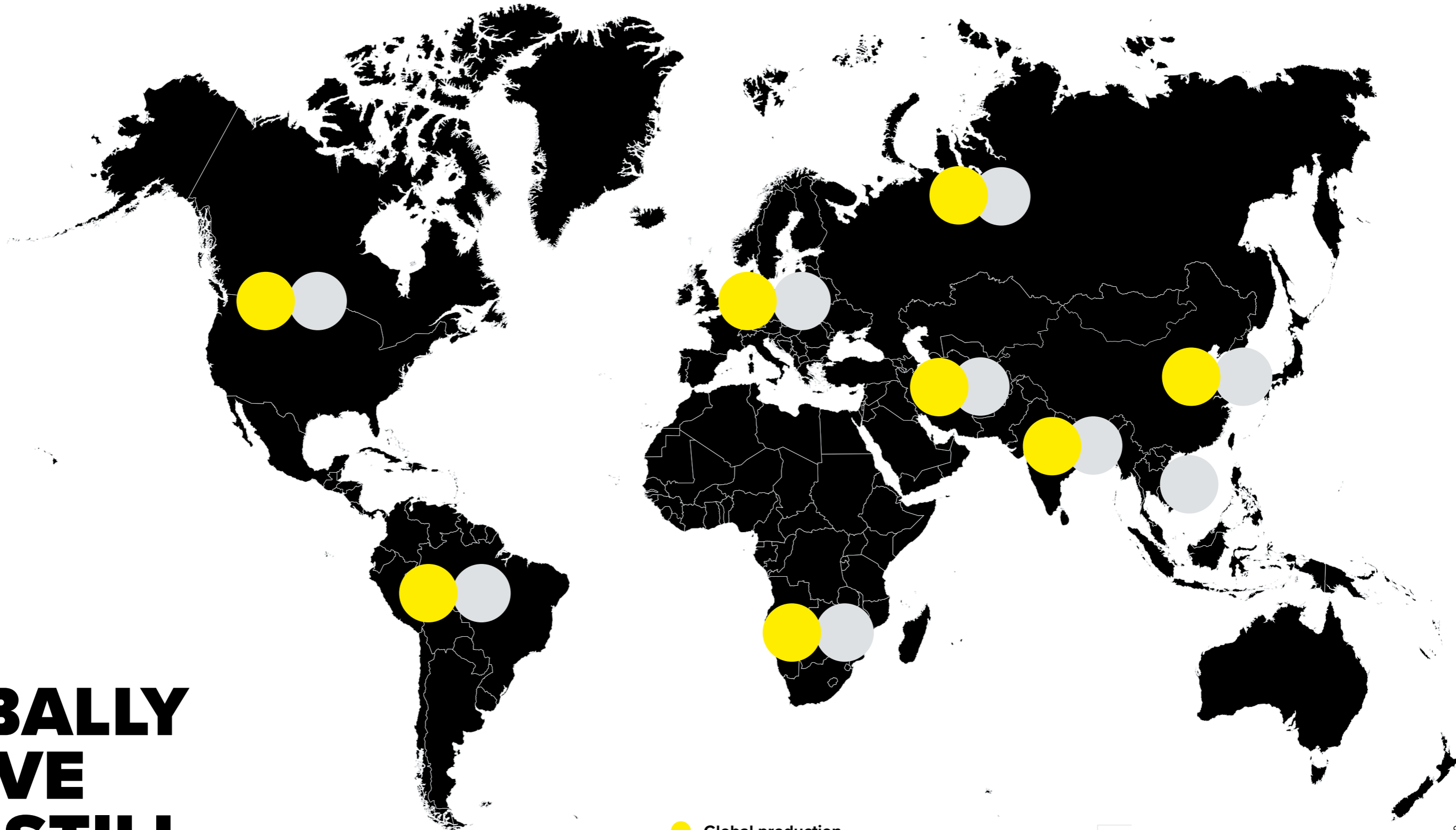

GLOBALLY ACTIVE AND STILL CLOSE BY

No matter where your market is, regardless of country, we are never far away. We are always happy to answer any questions you may have and meet your requirements. Even the largest, most successful project begins with an initial, profitable conversation. We look forward to hearing from you.

- Global production footprint
- Global sales and service