

## Installation/operation manual Type S ball valve



Translation of the original Operation Manual  
Keep for future use!

# Introduction

This manual is written for installation, operating, maintenance and supervisory personnel.

This manual also describes components and auxiliary units that are not included or are only partially included in the scope of supply.

The manual must be read, understood and observed by the user. We emphasize that Franz Schuck GmbH assumes no liability for damage or malfunctions arising from non-compliance with this manual.

With regard to the illustrations and information in this manual, we reserve the right to make technical modifications.

# Copyright

The copyright for this manual remains with Franz Schuck GmbH.

The instructions and drawings contained herein may not be reproduced or disseminated either fully or in part, nor used for competitive purposes or communicated to other parties without authorization.

# Table of Contents

<b>Chapter 1</b>	<b>Preliminary remarks</b>	<b>1-1</b>
<b>1.1</b>	<b>Legal notes</b>	<b>1-1</b>
<b>1.2</b>	<b>Application range</b>	<b>1-1</b>
<b>Chapter 2</b>	<b>Safety</b>	<b>2-1</b>
<b>2.1</b>	<b>Fundamental safety instructions</b>	<b>2-1</b>
2.1.1	General	2-1
2.1.2	Intended use	2-3
2.1.3	Organizational measures	2-4
2.1.3.1	Special hazard points	2-4
2.1.3.2	Workplace and personal protective gear	2-5
<b>Chapter 3</b>	<b>Description</b>	<b>3-1</b>
<b>3.1</b>	<b>System overview</b>	<b>3-1</b>
3.1.1	Identification plate	3-2
3.1.2	Construction and design	3-3
3.1.3	Sealing off the outlet	3-3
3.1.4	Sealing out the atmosphere	3-3
3.1.5	Actuating stem	3-3
3.1.6	Actuation	3-4
3.1.7	Accessories and connections	3-4
3.1.7.1	Boroscope (optional)	3-5
<b>Chapter 4</b>	<b>Assembly</b>	<b>4-1</b>
<b>4.1</b>	<b>Preparation</b>	<b>4-3</b>
4.1.1	As-delivered condition	4-3
4.1.2	Inspection	4-4
4.1.3	Storage	4-4
4.1.4	Transport	4-4

<b>4.2</b>	<b>Installation</b>	<b>4-6</b>
4.2.1	General installation instructions	4-6
4.2.2	Ball valves with weld ends	4-7
4.2.3	Ball valves with flanges	4-7
4.2.4	Valve installation	4-8
4.2.5	Connection and start-up of actuator and control system	4-8
<b>4.3</b>	<b>Testing</b>	<b>4-9</b>
4.3.1	Function test	4-9
4.3.2	Pressure/leak tightness test	4-9
<b>Chapter 5</b>	<b>Operation</b>	<b>5-1</b>
<b>5.1</b>	<b>Safety instructions for operation</b>	<b>5-1</b>
<b>5.2</b>	<b>Operation</b>	<b>5-2</b>
5.2.1	Open/close valve	5-2
<b>Chapter 6</b>	<b>Maintenance</b>	<b>6-1</b>
<b>6.1</b>	<b>Inspection</b>	<b>6-2</b>
6.1.1	Regular maintenance	6-2
6.1.2	Venting/drain	6-2
6.1.3	Double block and bleed test	6-3
6.1.4	Injecting sealant (optional)	6-3
6.1.4.1	Internal leaks on seat rings	6-3
6.1.4.2	Sealing the actuating stem	6-4
6.1.5	Faults and troubleshooting	6-4
6.1.6	Inspection intervals	6-4
<b>6.2</b>	<b>Repairs</b>	<b>6-5</b>
6.2.1	Spare parts for maintenance/repair works	6-6
6.2.2	Cleaning works to be carried out before reassembly	6-9
<b>Chapter 7</b>	<b>Appendix</b>	<b>7-1</b>
<b>7.1</b>	<b>Tightening sequence for flange bolts</b>	<b>7-1</b>
<b>7.2</b>	<b>Tightening torques for housing screws</b>	<b>7-2</b>
<b>7.3</b>	<b>Conversion factors</b>	<b>7-3</b>

<b>7.4</b>	<b>Calculation formula to determine the carbon equivalent (CEV)</b>	<b>7-4</b>
7.4.1	Calculation formula (standard)	7-4
7.4.2	Calculation formula for steels with different consistencies	7-4
<b>7.5</b>	<b>Sealant requirement per ball valve (above ground)</b>	<b>7-5</b>
<b>7.6</b>	<b>Marking of packages</b>	<b>7-6</b>
7.6.1	Marking of packages according to DIN 55402 and ISO R 780	7-6
7.6.2	Schuck symbols – transporting and unpacking packages	7-7

# 1 Preliminary remarks

## CAUTION

Danger of consequential damage due to incorrect operation, maintenance and/or handling!

We explicitly emphasize that we assume no liability for damage or malfunctions arising from non-compliance with this manual.

⇒ Therefore it is important to comply with all instructions in this manual!

This manual is to provide technicians and users with the necessary information for assembly and adjustment work and to help in performing work quickly and correctly.

For your own safety, read this manual carefully and pay particular attention to the highlighted tips. In any case, keep this manual to hand.

Pay special attention to all safety instructions in this manual. You will find the safety instructions in Chapter 2, in the introductions to chapters and before practical instructions. The General Terms and Conditions of the company apply exclusively to all deliveries and performances made by Franz Schuck GmbH, including any future transactions.

## 1.1 Legal notes

The component may only be installed and operated by skilled personnel.

Please check parts upon receipt for any possible damage that may have occurred during transport. Only undamaged parts may be fitted or used.

No warranty can be claimed if maintenance work is neglected or carried out incorrectly. Only original spare parts guarantee quality, reliability and exchangeability.

Any modification(s) of the component are in general prohibited by Franz Schuck GmbH. The manufacturer guarantee becomes void if this prohibition is not complied with!

## 1.2 Application range

This operation manual applies to the Franz Schuck GmbH product described in this manual.

The appropriate operation manuals for optional accessories must also be observed.

These operation manuals are included in the overall documentation if the accessories belong to the scope of supply from Franz Schuck GmbH.

As of: 2013-01-07  
Revision: 2013/01

Author: Franz Schuck GmbH  
Editor: bitplant.de GmbH

Codeword: XML Source: 100: Kugelhahn  
Created with: TeXML v.schuck-latex-130207

## 2 Safety

### CAUTION

Dangers to the health and safety of operating and maintenance staff as well as to the functioning capacity of the valve. Dangers to the environment due to escaping gaseous or liquid media.

Escaping sour gas or sulphinic lye might cause life danger hazard!

Non-compliance with these instructions jeopardizes the obligation by Franz Schuck GmbH to follow through on the warranty/guarantee.

⇒ The instructions in the “Safety” Chapter must be unconditionally observed!

### 2.1 Fundamental safety instructions

#### 2.1.1 General

Modifications on valves and attachments which could affect safety may not be carried out without written permission from the manufacturer.

The guarantee becomes void if this prohibition is not complied with!



- This product has been manufactured according to the recognized rules of technology and according to internal Schuck quality standards; the product is shipped from the factory in a perfect technical condition
- Nevertheless, valves can cause hazards to people, material goods and the environment if operating personnel use them improperly or in a manner that is contrary to their intended use
- Any person dealing with assembly, commissioning, operation and/or maintenance of the valve must have read and understand this entire manual, and must be able to prove they possess professional qualifications for implementing the work
- Please observe the valid accident prevention regulations when installing the component
- Suitable protective gear must be worn when carrying out the works
- The manual must be kept safe and accessible at all times at the place where the valve is in use
- If malfunctions occur, notify Franz Schuck GmbH immediately and take appropriate measures
- Work on ball valves (such as inspection, servicing and/or maintenance work) may only be carried out in a depressurized state and with the energy supply secured and switched off

- Valves must be effectively covered and/or protected when work is being carried out that could lead to contamination or damage to the valve, the assembled parts and/or the anti-corrosion protection

As of: 2013-01-07  
Revision: 2013/01

Author: Franz Schuck GmbH  
Editor: bitplant.de GmbH

Codeword: XML Source: 100: Kugelhahn  
Created with: TeXML v.schuck-latex-130207



### **2.1.2 Intended use**

The ball valve supplied is designed exclusively to allow or block the flow of media in pipelines.

Depending on the sealing system, the ball valve can be used both for gaseous and liquid media.

Any other media and/or applications outside the permissible pressure and temperature range can lead to damage and/or leaks.

Intended use includes observing the instructions in this operating manual and adhering to the operating conditions on the identification plate, the final inspection certification and drawings, as well as observing the locally applicable accident prevention guidelines and regulations for protecting the environment.

Any operating conditions or applications which differ from those prescribed are only valid with the agreement of Franz Schuck GmbH!

As of: 2013-01-07  
Revision: 2013/01

Author: Franz Schuck GmbH  
Editor: bitplant.de GmbH

Codeword: XML Source: 100: Kugelhahn  
Created with: TeXML v.schuck-latex-130207

## 2.1.3 Organizational measures

### 2.1.3.1 Special hazard points

There is no immediate danger from a valve that is installed and serviced according to instructions.

- Danger from escaping media
  - depending on the working medium, fire or explosion hazards can arise from electrical contact, naked flames, light and/or smoking
  - there is a risk of poisoning, chemical burns, scolding and environmental pollution
  - hazardous materials must be collected or sucked up, if necessary, and disposed of properly
- The voltage in electrically operated ball valves poses a potential danger
  - all work on electrical installations may only be carried out by trained electricians and only at zero potential
- Stored energy is an imminent danger in the case of ball valves that are actuated pneumatically, hydraulically or gas-hydraulically
  - all energy-storing systems must be depressurized during servicing and maintenance works
  - Work on the ball valve may only be carried out in a depressurized state. This also applies for the disassembly of caps and screw connections as well as adjustment works on the ball valve.

As of: 2013-01-07  
Revision: 2013/01

Author: Franz Schuck GmbH  
Editor: bitplant.de GmbH

Codeword: XML Source: 100: Kugelhahn  
Created with: TeXML v.schuck-latex-130207

### 2.1.3.2 Workplace and personal protective gear

Sufficient space is required for carrying out assembly and maintenance work safely. The operator must ensure that the workplace is clean and clearly arranged.

If media (including residues) can escape in case the ball valve or the actuator system experiences operational faults or malfunctions, then the endangered persons must use suitable personal protective gear, as far as this is necessary.

Only use components in a technically perfect condition; use them according to specifications in a safety and risk-conscious manner while complying with the operation manual! Remedy faults in particular that could impair safety (or have them remedied)!

The operating manual must be supplemented by instructions which take into account supervisory and reporting duties with regard to work related particularities, e.g. in respect of how work is organized, working procedures and the personnel employed.

Technically trained staff commissioned to work on a component must have read the chapter on safety in this operating manual **before starting work**. Staff must already be aware of potential hazard sources when working to be in a position to react quickly and correctly. This applies in particular to staff who are only employed occasionally to work on a component, e.g. when setting up or servicing.

Observe all safety and hazard instructions for the equipment/the component!

Make sure all safety and hazard signs are complete and legible!

No modifications, attachments or conversions which could impair safety may be implemented without authorization from Franz Schuck GmbH! This also applies to the assembly and the adjustment of safety devices and safety valves as well as for welding on load-bearing parts.

Lubricants and sealing compounds as well as spare parts should conform to the technical specifications. This is always guaranteed when using original spare parts.

Replace hydraulic and pneumatic hose lines in specified or appropriate intervals, even if no security-relevant defects are evident.

Adhere to the prescribed deadlines, or the deadlines stated in the operation manual, for recurring tests/inspections!

Appropriate workshop equipment is essential for carrying out maintenance work.



Make sure the location or fire extinguishers is clearly indicated and operating instructions are available!

Make sure to observe the fire alarm and fire fighting instructions!

As of: 2013-01-07  
Revision: 2013/01

Author: Franz Schuck GmbH  
Editor: bitplant.de GmbH

Codeword: XML Source: 100: Kugelhahn  
Created with: TeXML v.schuck-latex-130207

	 <b>DANGER</b>
	Risk of injury from bursting components/system parts!
	If the permissible limit values are exceeded, the component/system can be destroyed, and as a consequence of this persons can be injured or killed!
⇒ Always operate components/system parts within the permissible limit values!	

## 3 Description

### 3.1 System overview

#### Task

Depending on the design, the ball valve is used as shut-off device in pipelines for the transport of gaseous or liquid media.

#### Components

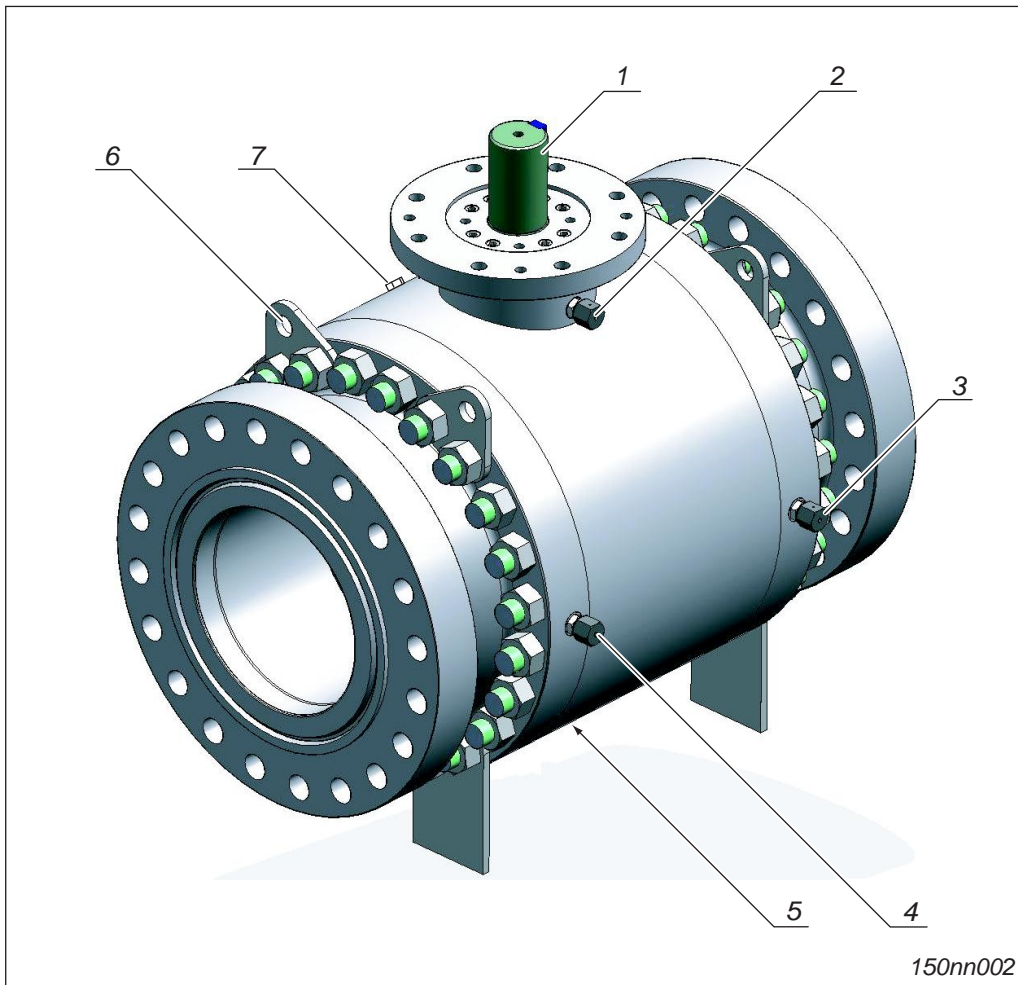

Fig. 3-1 System overview type S ball valve

- |   |   |
|---|---|
| 1 Actuating stem  | 4 Injection head for secondary sealant on the seat (optional) |
| 2 Injection head for secondary sealant on actuating stem (optional) | 5 Drainage (optional, not visible here)                       |
| 3 Injection head for secondary sealant on the seat (optional)       | 6 Suspension eye  |
|   | 7 Vent (optional)   |

#### Function

Rotating the ball plug by 90° achieves the “OPEN” or “CLOSED” position of the ball valve, i.e. the entire cross sectional area of the ball outlet is released or blocked for the passage of the delivery flow.

As of: 2013-01-07  
Revision: 2013/01

Author: Franz Schuck GmbH  
Editor: bitplant.de GmbH

Codeword: XML Source: 100: Kugelhaeh  
Created with: TeXML v.schuck-latex-130207

### 3.1.1 Identification plate

For valves specified for above ground installation, the identification plate is attached to the housing body; on the underground model, it is also optionally positioned in the upper area of the pipe or extension.

#### Components

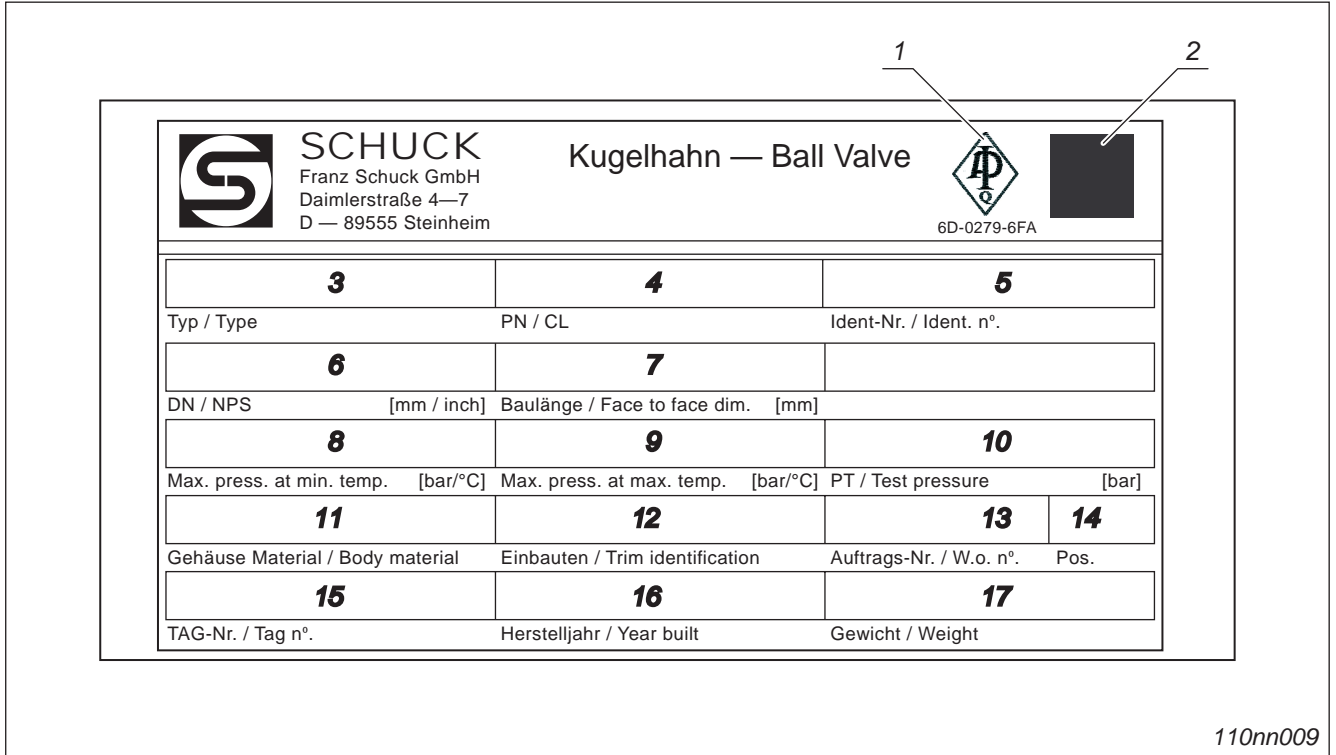

Fig. 3-2 Information on the identification plate

- |  |  |
|--|--|
| <b>1</b> CE/API mark   | <b>9</b> Max. permissible operating pressure PS at maximum temperature |
| <b>2</b> Space for acceptance reference by an expert                   | <b>10</b> Test pressure PT   |
| <b>3</b> Type  | <b>11</b> Body material  |
| <b>4</b> Nominal pressure PN/ANSI class                                | <b>12</b> Reference for built-in structures                            |
| <b>5</b> Ident no.   | <b>13</b> Order no.  |
| <b>6</b> Nominal diameter DN/NPS                                       | <b>14</b> Order position   |
| <b>7</b> Face-to-face dimension  | <b>15</b> TAG no. (optional)   |
| <b>8</b> Max. permissible operating pressure PS at minimum temperature | <b>16</b> Year built   |
|  | <b>17</b> Weight   |

As of: 2013-01-07  
Revision: 2013/01

Author: Franz Schuck GmbH  
Editor: bitplant.de GmbH

Codeword: XML Source: 100: Kugelhahn  
Created with: TeXML v.schuck-latex-130207

### 3.1.2 Construction and design

Type S ball valves are bolted, two- to three-part constructions. The ball plug is trunnion-mounted in the casing.

The ball valve is designed for above ground use. The valve may not be installed in underground pipelines without the manufacturer's consent.

Type S ball valves are available with weld ends for welding into the pipe or with flange ends.

Ball valves with complete bores have a smooth, circular outlet without constriction and pigs whose dimensions and design do not compromise the functioning of the ball valve can be passed through them

With reduced valves or Venturi models, only the connecting pieces are developed in a tapered form as a junction to the larger pipeline. Piggability is possible only to a very limited extent with special pigs and after consultation.

The structural lengths of the ball valves are stipulated according to API – 6D or EN 558 – 1 depending on nominal diameter and pressure ranges. Special structural lengths are possible on request.

### 3.1.3 Sealing off the outlet

The outlet is sealed by two seat rings positioned on opposite sides in contact with the ball.

Depending to the requirements, the sealing system can be designed to be soft-seated, PMSS (primary metallic, secondary soft seated) or just metal-to-metal.

For gaseous media, seat rings with a double piston effect are usually used; for liquid media, seat rings with a single piston effect are used. Combinations are also possible.

### 3.1.4 Sealing out the atmosphere

The actuating stem is double-sealed against the atmosphere in the housing. The first seal is a special grooved ring. O-rings are installed as second seal.

Additionally, a fire safe sealing package with a graphite ring is usually installed. If necessary, the sealing package can be replaced.

In principle, repair work may only be carried out by the Franz Schuck GmbH service team or by personnel trained by Franz Schuck.



### 3.1.5 Actuating stem

The actuating stem transfers the quarter rotation for opening and closing.

It is not possible to release the actuator stem from the housing during operation (blow out protection).

As of: 2013-01-07  
Revision: 2013/01

Author: Franz Schuck GmbH  
Editor: bitplant.de GmbH

Codeword: XML Source: 100: Kugelhahn  
Created with: TeXML v.schuck-latex-130207

### 3.1.6 Actuation

Depending on the order, the ball valve can either be supplied with manual actuation (hand wheel or hand lever) or with an electrical/pneumatic/hydraulic valve actuator.

The ball valve is usually opened by an anticlockwise 90° rotation on the actuating stem. It is closed by clockwise rotation.

The ball valve has no internal stops to limit the rotation angle. The rotation angle is limited by adjustable limit stops in the drive.

Please observe the operating manuals for actuator and control system (accessories).

### 3.1.7 Accessories and connections

Depending on the order, the ball valve can be equipped from the factory with optional accessories or with interfaces for other accessories (→ Page 3-1, Fig. 3-1 and → Page 6-7, Fig. 6-1).

- Drainage
- Ventilation
- Injection heads for secondary sealant
- Pressure supply for gas-over-oil actuator system
- Pressure gauge connection
- Hydraulic seat ring pressing

As of: 2013-01-07  
Revision: 2013/01

Author: Franz Schuck GmbH  
Editor: bitplant.de GmbH

Codeword: XML Source: 100: Kugelhahn  
Created with: TeXML v.schuck-latex-130207

### 3.1.7.1 Boroscope (optional)

#### 3.1.7.1.1 Types

- Long boroscope: D8 x 465 mm – rigid version with cross line
- Short boroscope: D8 x 200 mm – rigid version with cross line

#### Accessories

- Lighting: Battery hand light source for boroscope

#### 3.1.7.1.2 Description

##### Task

The boroscope is a tool that allows exact positioning of the ball in the end positions. Open and closed position of the ball valve can be both adjusted and checked independently of the actuator.

##### Components

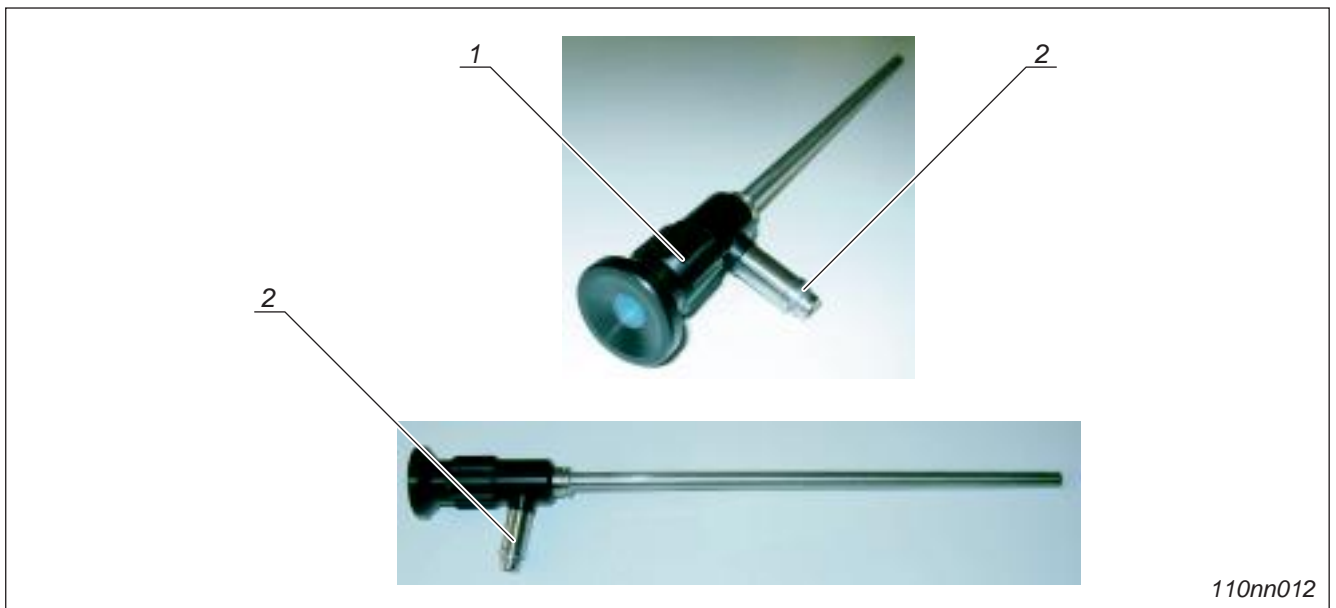

Fig. 3-3 Boroscope

**1** Boroscope

**2** Connection for lighting

As of: 2013-01-07  
Revision: 2013/01

Author: Franz Schuck GmbH  
Editor: bitplant.de GmbH

Codeword: XML Source: 100: Kugelhahn  
Created with: TeXML v.schuck-latex-130207



### Function

The boroscope comes with a cross line that guarantees exact adjustment and control of the ball end position. The boroscope can also be illuminated, the marking on the actuating stem is thus clearly visible.

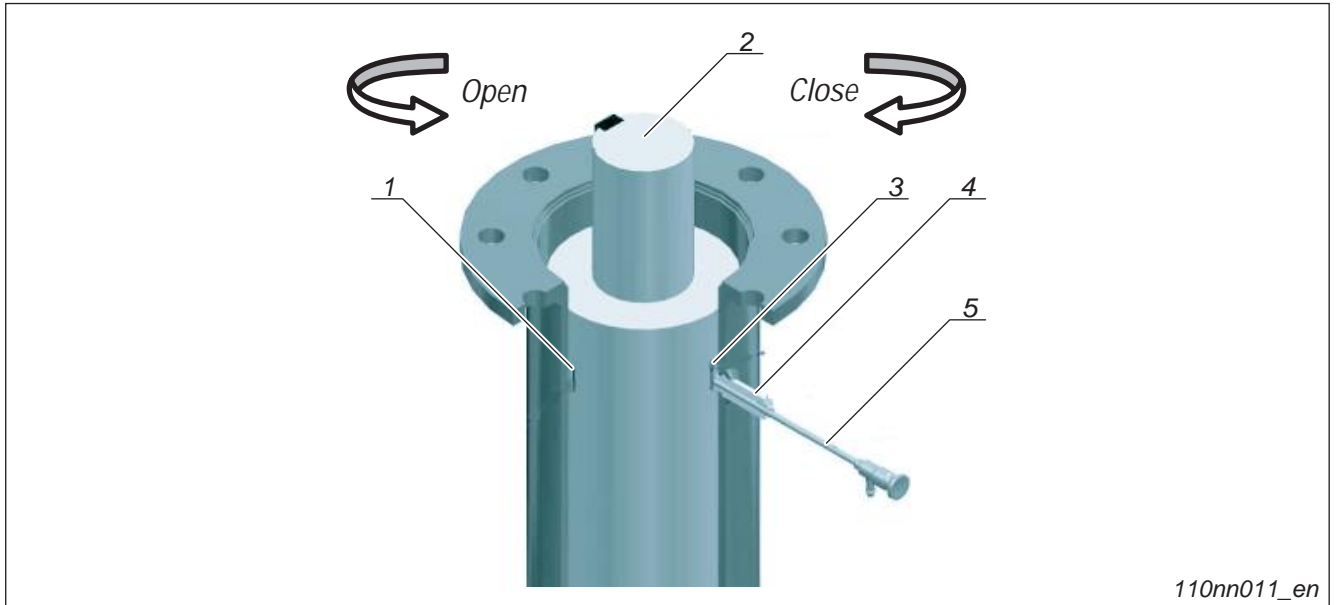

As of: 2013-01-07  
Revision: 2013/01

110nn011\_en

Fig. 3-4 Actuating stem with boroscope opening, underground type

- |                          |                         |
|--------------------------|-------------------------|
| <b>1</b> Open position   | <b>4</b> Boroscope bush |
| <b>2</b> Actuating stem  | <b>5</b> Boroscope      |
| <b>3</b> Closed position |                         |

Author: Franz Schuck GmbH  
Editor: bitplant.de GmbH

Codeword: XML Source: 100: Kugelhahn  
Created with: TeXML v.schuck-latex-130207



## 4 Assembly

For questions regarding assembly, please contact:



**Franz Schuck GmbH**  
Daimlerstraße 5 – 7  
89555 Steinheim  
GERMANY  
Phone +49 (7329) 950-0  
Fax +49 (7329) 950-161

info@schuck-group.com  
www.schuck-group.com



As of: 2013-01-07  
Revision: 2013/01

	 <b>DANGER</b>
	Risk of injury from bursting components/system parts!
	If the permissible limit values are exceeded, the component/system can be destroyed, and as a consequence of this persons can be injured or killed!
	⇒ Always operate components/system parts within the permissible limit values!

Author: Franz Schuck GmbH  
Editor: bitplant.de GmbH

	 <b>DANGER</b>
	Risk of injury from bursting components/system parts!
	Only carry out installation work when the valve is depressurized! The on-site instructions of the operator must be additionally observed.
	⇒ Ensure that the system is depressurized and that no gas is present in the environment before starting installation work.
	⇒ Block the gas flow as specified by the operating company.
	⇒ Open the venting and discharge opening and secure mechanically against closing.

Codeword: XML Source: 100: Kugelhahn  
Created with: TeXML v.schuck-latex-130207

	 <b>DANGER</b>
	<p>Danger of electric shock!</p> <p>⇒ Do not connect the system to power before the earth resistance and the earthing connection has been tested, examined and approved by the customer.</p>



<b>CAUTION</b>
<p>Danger of hardness increase of the steel when welding without pre-heating the weld junction at temperatures exceeding 80 °C!</p> <p>⇒ Pre-heat the weld-on ends depending on the carbon equivalent (CEV) before starting the welding process.</p> <p>⇒ Observe the instructions concerning the CEV (→ Page 7-4, Chapter 7.4).</p> <p>⇒ Make sure to monitor the temperature when pre-heating and welding! Suitable measures (such as cooling, extending the weld-on ends without coating, dismantling, etc.) must be taken to avoid elevated temperatures in areas with coated surfaces. Temperatures of up to 100 °C are permissible for a short time.</p>

As of: 2013-01-07  
Revision: 2013/01

Author: Franz Schuck GmbH  
Editor: bitplant.de GmbH

Codeword: XML Source: 100: Kugelhahn  
Created with: TeXML v.schuck-latex-130207

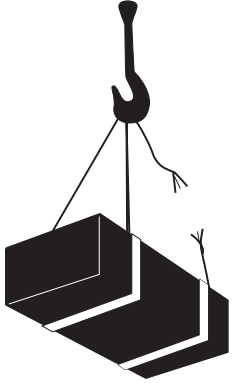
## 4.1 Preparation

	 <b>DANGER</b>
	LIFE HAZARD from suspended loads or shifting of loads!
	Proceed cautiously when transporting the valve!
	<ul style="list-style-type: none"><li>⇒ To lift the ball valve only use appropriate lifting devices as well as the designated lifting points.</li><li>⇒ Never hang or raise the ball valve on drive parts or piping systems!</li><li>⇒ Lifting devices, industrial trucks and load-carrying equipment and must comply with the current regulations!</li></ul>

### Notes on transport and unloading

- Load-carrying equipment according to directive 2006/42/EG (Machinery Directive)
- For the exact weight of the ball valves → identification plate on the ball valve
- Please observe the notes on the transport packaging → Page 7-6, Chapter 7.6
- Loads must be set upright or lifted according to → Page 4-4, Chapter 4.1.4

#### 4.1.1 As-delivered condition

If no other contractual agreements have been made, the valves are supplied for transport under the following conditions:

- weld-on ends and mounted flange sides are coated with an anti-corrosive product
- the ball valve is in “OPEN” position
- valve ends are sealed with PE protective caps or wooden caps to prevent the penetration of dirt and moisture
- the ball valves are packed on wooden pallets or boxes

As of: 2013-01-07  
Revision: 2013/01

Author: Franz Schuck GmbH  
Editor: bitplant.de GmbH

Codeword: XML Source: 100: Kugelhahn  
Created with: TeXML v.schuck-latex-130207

#### 4.1.2 Inspection

##### Procedure

1. Check the delivery notes to make sure that the delivery is complete.
2. If there are any discrepancies, contact Franz Schuck GmbH immediately.
3. Check the delivery immediately on receipt for damage incurred during transport.

In the event of damage, observe the stipulations of the insurance company which, among other things, prescribe that evidence of damage is confirmed immediately by the forwarding agent.

4. If applicable, photograph damage to proof evidence.

#### 4.1.3 Storage

If possible store the valve in its original packaging.

Take suitable measures to protect the valve against external influences, dirt and moisture.

#### 4.1.4 Transport

##### Procedure

If the actuator is already assembled to the ball valve, please observe the safety instructions on lifting (→ Page 4-5, Fig. 4-1)!

For further information → Actuator installation/operation manual.



1. Only use the original packaging for transporting the valve to its place of installation.  
The valve can be damaged by incorrect handling.
2. Only use lifting devices that are appropriate to the weight being moved. Please observe the notes on the transport packaging → Page 7-6, Chapter 7.6.
3. Use appropriate protective materials and/or edge protectors when using steel cables or chains in order to protect the outer coating.
4. Ensure the load does not tip sideways.
5. Loads must be set upright or lifted according to the following drawings. Never use attachments or pipes!
6. When using suspension eyes, always use two eyes or more!

As of: 2013-01-07  
Revision: 2013/01

Author: Franz Schuck GmbH  
Editor: bitplant.de GmbH

Codeword: XML Source: 100: Kugelhahn  
Created with: TeXML v.schuck-latex-130207

**Overview**

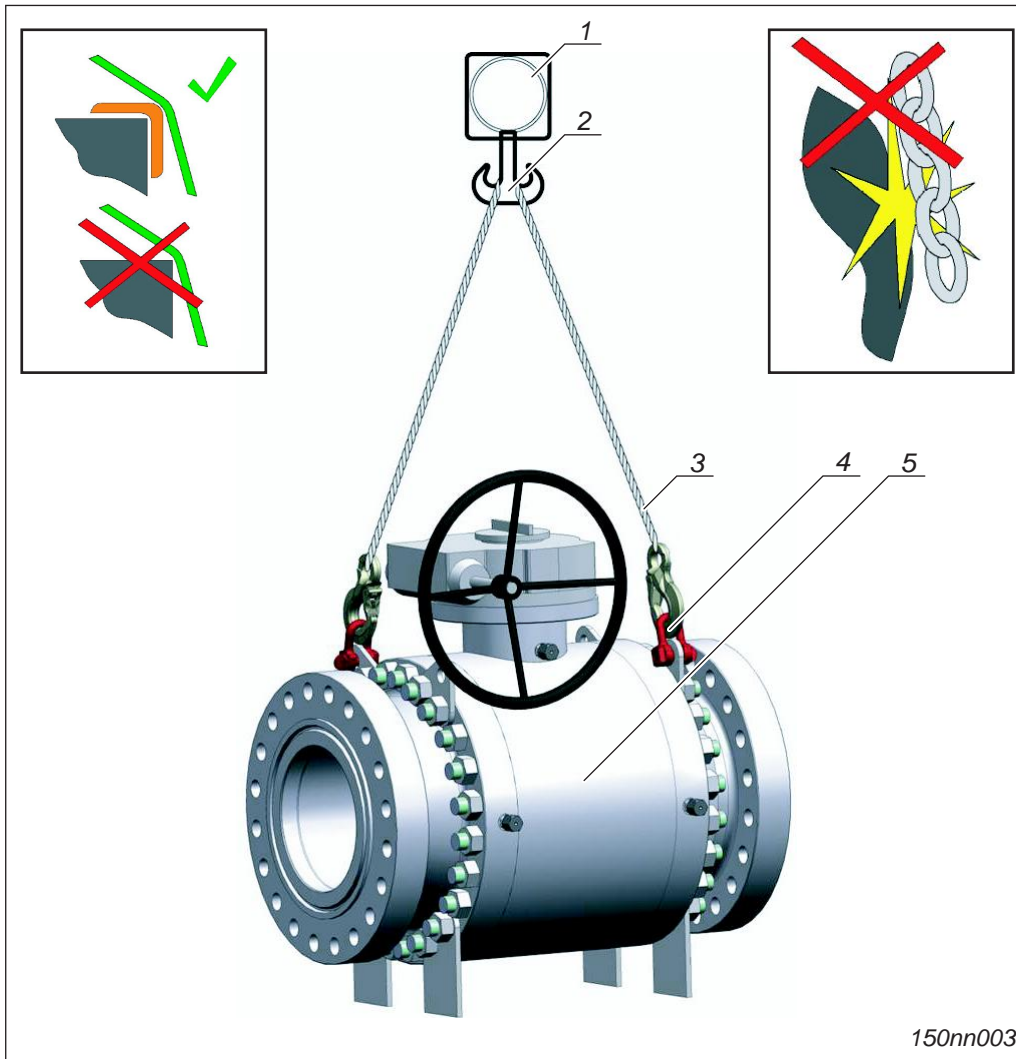

150nn003

Fig. 4-1 Transporting type S ball valves

- |                         |                         |
|-------------------------|-------------------------|
| <b>1</b> Mounting       | <b>4</b> Suspension eye |
| <b>2</b> Lifting device | <b>5</b> Ball valve     |
| <b>3</b> Lifting rope   |                         |

As of: 2013-01-07  
 Revision: 2013/01

Author: Franz Schuck GmbH  
 Editor: bitplant.de GmbH

Codeword: XML Source: 100: Kugelhahn  
 Created with: TeXML v.schuck-latex-130207

## 4.2 Installation

### CAUTION

Damage to the component in the case of mechanical overloading!  
The component is not designed as fixed point/support of the pipeline.  
⇒ Extra support on the pipeline is required.

#### 4.2.1 General installation instructions

Unless otherwise agreed, the valve is designed to be installed in horizontal pipelines by default. The actuating stem is aligned vertically pointing upwards (actuator positioned above the valve). Other installation positions are possible if specified at time of order.

If the valve is provided with a flow direction arrow, the installation position must match the flow direction.

The valve must be installed in the pipeline free from mechanical stress.

If necessary, position the ball valve on a suitable foundation in order to avoid any bending, torsion, pushing or tractive strain.

Observe the operation manuals for actuator and control system when connecting the energy supply to the actuator.

On completion of the installation, check the coating of the ball valves and, where necessary, refinish according to the applicable ATEX directives.

As of: 2013-01-07  
Revision: 2013/01

Author: Franz Schuck GmbH  
Editor: bitplant.de GmbH

Codeword: XML Source: 100: Kugelhahn  
Created with: TeXML v.schuck-latex-130207

#### **4.2.2 Ball valves with weld ends**

For delivery, the weld ends have been provided with anti-corrosion protection. The weld ends must be carefully cleaned before being welded into the pipeline.

Use control measurements when pre-heating and welding to ensure that the temperature around these seals/seat rings does not exceed 150 °C (→ Page 3-1, Fig. 3-1, item 3 and 4). At higher temperatures, the seals can be damaged.

Welding must be carried out using an appropriate process and must be in accordance with all requisite instructions and requirements (test procedure, welding test, welding plan, test plan, etc.).

Apply an appropriate anti-corrosion protection as soon as possible after finishing the weld seams.

#### **4.2.3 Ball valves with flanges**

For delivery, the flange sealing surfaces have been provided with anti-corrosion protection. The flange sealing surfaces must be carefully cleaned before being installed in the pipeline.

The flange seals and bolts must be suited for sealing strip shape, pressure, temperature and medium.

The pipeline counter flanges must be aligned plane-parallel and concentrically.

Retighten the screw connections crosswise and evenly with the appropriate tightening torque.

Recommended tightening sequence (→ Page 7-1, Fig. 7-1).

As of: 2013-01-07  
Revision: 2013/01

Author: Franz Schuck GmbH  
Editor: bitplant.de GmbH

Codeword: XML Source: 100: Kugelhahn  
Created with: TeXML v.schuck-latex-130207



#### 4.2.4 Valve installation

##### Prerequisite

- The mechanical components of the system have been tested
- All damage has been reported and remedied
- General safety instructions have been observed prior to assembly/disassembly
- Preparatory measures have been met
- Direct hazard sources (electric/temperature/mechanical/crush, etc.) are excluded

##### Procedure

1. Do not remove the packaging of the valve and the protective caps until installing the valve.
2. Carefully remove the anti-corrosion protection on the flange sealing surfaces or the weld-on ends using appropriate means.
3. Examine the pipelines for contamination and foreign particles before installation, and clean if necessary.
4. Ensure that no contamination or foreign body can enter the pipeline or the valve during assembly work.  
Ball plugs and seat rings can be unnecessarily strained or damaged by dirt, rust or residual assembly-related materials.
5. Install the valve into the pipeline with the ball position "OPEN".
6. Install the valve into the pipeline as stress-free as possible.  
External tractive, compressive or bending forces must be avoided or reduced to a minimum using suitable measures (such as erecting a foundation).
7. Ensure that inner and outer coating are not damaged during installation.

#### 4.2.5 Connection and start-up of actuator and control system

##### Safety instruction

The energy supply for the actuator must be connected according to the operating manuals for actuator and control system.

It may be necessary to move the ball valve manually to the intermediate position (→ Actuator installation/operation manual) before starting up the actuator.



As of: 2013-01-07  
Revision: 2013/01

Author: Franz Schuck GmbH  
Editor: bitplant.de GmbH

Codeword: XML Source: 100: Kugelhahn  
Created with: TeXML v.schuck-latex-130207

## 4.3 Testing

### 4.3.1 Function test

Before applying pressure to the ball valve for the first time, a function test must be carried out when it is de-pressurized.

#### Procedure

1. Clean the interior of the ball valve properly.  
All impurities and foreign bodies must be removed in particular around the seat rings.
2. Then close the ball valve completely and open it again.  
The ball valve must run through the entire stroke trouble-free.

After being opened, the ball outlet must return to being concentric in relation to the pipe. Disconnection at the end positions should be dependent on the distance and not on the torque.

### 4.3.2 Pressure/leak tightness test

Only use mechanically clean water with an admixture of anti-corrosive agent as a test medium.

If no anti-corrosive agent is used, the ball valve must be drained and dried as quickly as possible after the pressure test in order to avoid corrosion.

#### Procedure

1. Completely fill the pipe section being tested and the fully open ball valve with water.
2. Close the ball valve by approx. 80 – 90% (approx. 75 – 80°) to fill the dead spaces.  
Any cushion of air remaining in the dead space can be discharged via the optional ball valve venting device, while relieved of pressure.
3. Carry out the pressure test according to instructions.  
The maximum test pressure (PT) stated on the identification plate must not be exceeded.
4. Completely open the ball valve on completing the pressure test.
5. Discharge the pipe section and drain the ball valve using the drainage device.
6. If you intend to dry it, the ball valve can be moved to an intermediate position of 80% closed in order to dry out the dead space in the ball valve.
7. The temperature in the ball valve must not exceed 80 °C during the drying process with hot air.

As of: 2013-01-07  
Revision: 2013/01

Author: Franz Schuck GmbH  
Editor: bitplant.de GmbH

Codeword: XML Source: 100: Kugelhahn  
Created with: TeXML v.schuck-latex-130207

## 5 Operation

### 5.1 Safety instructions for operation

Comply with the safety instructions and protective measures specified in chapter 2 as well as the applicable legal regulations.



	 <b>DANGER</b>
	Risk of injury from bursting components/system parts!
	If the permissible limit values are exceeded, the component/system can be destroyed, and as a consequence of this persons can be injured or killed!
	⇒ Always operate components/system parts within the permissible limit values!

<b>CAUTION</b>
Incorrect operation of the component can lead to damages or function changes!
⇒ Carry out all operational steps carefully.

As of: 2013-01-07  
Revision: 2013/01

Author: Franz Schuck GmbH  
Editor: bitplant.de GmbH

Codeword: XML Source: 100: Kugelhahn  
Created with: TeXML v.schuck-latex-130207

## 5.2 Operation

In order to ensure long-term sealing action of the valve, make sure that the ball plug is always completely opened or closed and never operated in an intermediate position.

Always adhere to the values stated on the identification plate (→ Page 3-2, Fig. 3-2) and the maximum permissible operating conditions.

### 5.2.1 Open/close valve

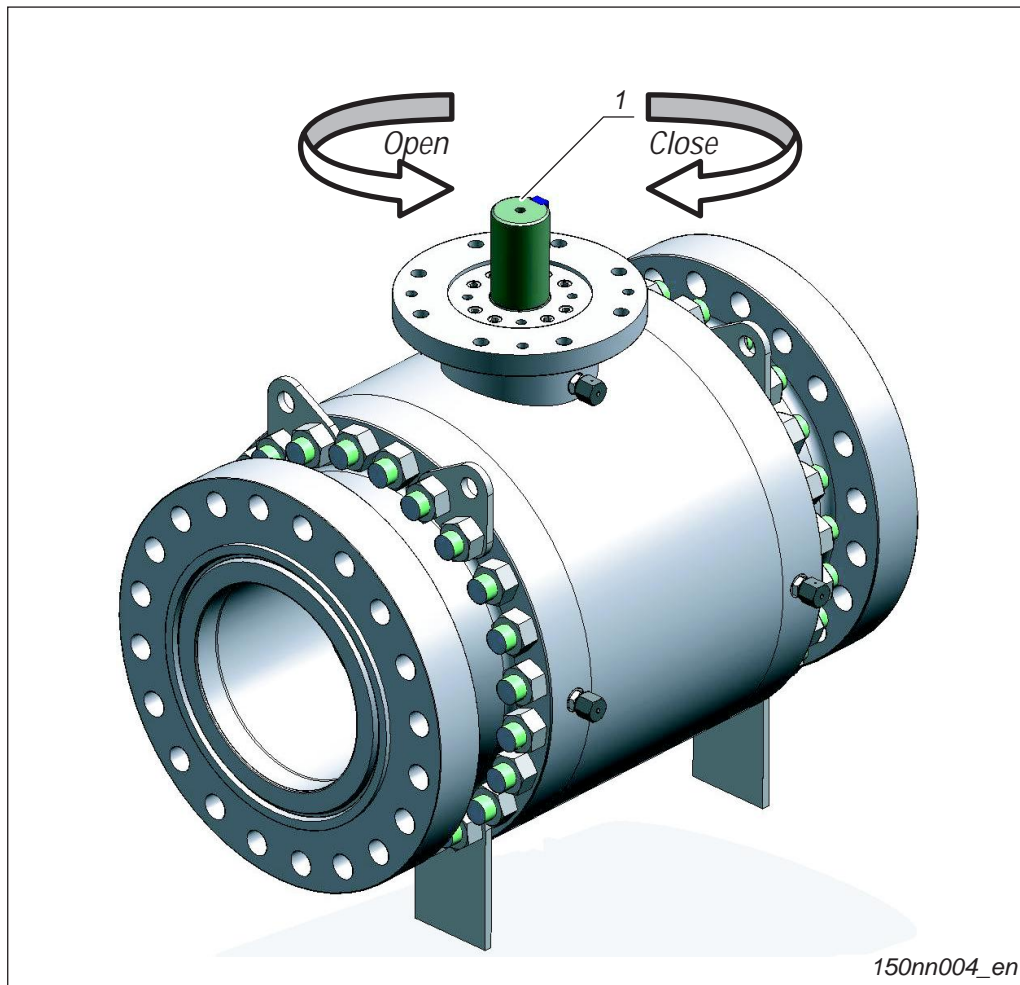

Fig. 5-1 Open/close ball valve

#### 1 Actuating stem

##### Open valve

⇨ Turn the ball plug anti-clockwise by 90° via the actuating stem (1) by using the manual lever, handwheel or drive.

##### Close valve

⇨ Turn the actuating stem 90° clockwise.

## 6 Maintenance

### CAUTION

Dangers to health and safety of operating and maintenance personnel. Dangers to the environment.

Personnel can be harmed by external energy or stored energy. Escaping gaseous or liquid media can be harmful to personnel and the environment.

Life hazard in the case of escaping sour gas or sulphinic lye!

⇒ The safety instructions must be unconditionally observed!

For support in maintenance and optimization work, we recommend you contact the Franz Schuck GmbH service department.

#### **Franz Schuck GmbH**

Daimlerstraße 5 – 7

89555 Steinheim

GERMANY

Phone +49 (7329) 950-0

Fax +49 (7329) 950-161

[info@schuck-group.com](mailto:info@schuck-group.com)

[www.schuck-group.com](http://www.schuck-group.com)

As of: 2013-01-07  
Revision: 2013/01

Author: Franz Schuck GmbH  
Editor: bitplant.de GmbH

Codeword: XML Source: 100: Kugelhahn  
Created with: TeXML v.schuck-latex-130207

## 6.1 Inspection

### 6.1.1 Regular maintenance

Schuck ball valves are low-maintenance.

Maintenance work is limited to:

- regularly checking the seal tightness to the outside and inspecting the external anti-corrosion protection (visual inspection)
- function test of the ball valve (at least once a year)

#### Procedure

- ⇒ To test the function, operate the ball valve once through its full stroke.  
The ball valve must traverse the entire stroke evenly, jolt-free and without any conspicuous noises.

If the ball valve is not in a position to be fully closed, it suffices to close the ball valve by only approx. 25% and then to open it again fully immediately afterwards.

### 6.1.2 Venting/drain

#### CAUTION

Dangers to health and safety of operating and maintenance personnel.

During the venting and discharge/drainage procedures, medium can escape under high pressure and with a considerable noise.

- ⇒ Note the blow-out direction!  
Avoid contact with medium!
- ⇒ Wear ear protection and protective goggles!

The interior of the ball valve can be vented and discharged using optional accessories.

Depending on the order, the ball valve can be equipped with plugs, bleeder plugs, block ball valves or valves with pressure cap.

#### Procedure

1. Drain the ball valve before the frost period begins.
2. The ball valve must be in an end position (CLOSE or OPEN).
3. Open the drain valve and discharge and/or pump out the collected water/condensate or relieve the pressure on the inside of the ball valve via the vent valve.
4. Then close the drain valve again.

As of: 2013-01-07  
Revision: 2013/01

Author: Franz Schuck GmbH  
Editor: bitplant.de GmbH

Codeword: XML Source: 100: Kugelhahn  
Created with: TeXML v.schuck-latex-130207

### 6.1.3 Double block and bleed test

#### CAUTION

Dangers to health and safety of operating and maintenance personnel.  
During the venting and discharge/drainage procedures, medium can escape under high pressure and with a considerable noise.

- ⇒ Note the blow-out direction!  
Avoid contact with medium!
- ⇒ Wear ear protection!

The tightness of the ball valve in the outlet can be checked in the “OPEN” or “CLOSED” position with the “double block and bleed test”.

#### Procedure

- ⇒ Carefully open the venting or discharge device while the pipe is supplied with full operating pressure.  
No more medium should emerge once the dead space is no longer pressurized or under stress. For larger ball valves, this procedure can take up to 15 minutes.

On completion of this test, the dead space should be filled with the medium of the pipeline.



#### Procedure

- ⇒ Operate the ball valve once and move back to the end position.

### 6.1.4 Injecting sealant (optional)

Ball valves can be optionally equipped with a device for injecting secondary sealant which in emergencies enables leaks to be sealed off.

If secondary sealant is injected, only sealants that are suitable for the operating medium, the temperature and the pressure may be used.

For more information on the sealant requirement (→ Page 7-5, Tab. 7-4).

The sealant may only be injected with a sealant gun pressure of max. 1000 bar.



#### 6.1.4.1 Internal leaks on seat rings

##### Procedure

1. If there are unacceptable leaks on the main seal, inject sealant via the injection heads using a conventional sealant gun until the leak has stopped. While doing this, the ball valve must be in “CLOSED” position.
2. Sealing by means of injecting sealant must be carried out while observing the flow direction on the inlet end.

### 6.1.4.2 Sealing the actuating stem

#### Procedure

- ⇒ When sealing the actuating stem, note that the sealant injection pressure may only be minimally above the operating pressure and that only a minimal amount is required.

If the necessary injection pressure on the sealant gun increases dramatically, then the ring gap of the stem seal is filled with sealant and no more injection is required.



### 6.1.5 Faults and troubleshooting

Fault	Cause	Remedy during operation
Leak in seat	Actuator end position out of alignment	⇒ Re-adjust the actuator end positions (→ Actuator installation/operation manual).
	Wear on sealing ring Dirt	⇒ Vent dead space.
		⇒ Operate the ball valve several times across the full stroke.
		⇒ Inject secondary sealant.
Leak on actuating stem	Seals worn	⇒ Inject secondary sealant.
		⇒ Replace stem seal (repair work by Schuck service personnel).
Ball valve does not open/close	Actuator	⇒ Check actuator for correct functioning.
	Distance/torque setting incorrect	⇒ Check distance/torque setting and correct if necessary.
End position of ball out of alignment	–	Check and/or adjust the end position through the boroscope opening (→ Page 3-5, Chapter 3.1.7.1).

Tab. 6-1 Faults and troubleshooting

### 6.1.6 Inspection intervals

Time interval	Component	Action
Regularly (according to legal regulations and customer instructions)	Ball valve and accessories	Sealing test to outside Anti-corrosion protection
Annually	Ball valve	Function test
Before the frost period begins	Ball valve	Drain/bleed condensate

Tab. 6-2 Inspection time interval

As of: 2013-01-07  
Revision: 2013/01

Author: Franz Schuck GmbH  
Editor: bitplant.de GmbH

Codeword: XML Source: 100: Kugelhahn  
Created with: TeXML v.schuck-latex-130207



## 6.2 Repairs

It is recommended to have repair work carried out by the Franz Schuck GmbH service team or by personnel trained by the Franz Schuck GmbH only.

This is the only way to ensure that repairs are carried out correctly using original spare parts. This will maintain the validity of the warranty.



Observe the following instructions:

- If faults occur, immediately notify the Schuck service personnel in charge and take appropriate measures
- Do not carry out work on pressurized systems, do not open the equipment
  - De-pressurize system before starting work
- Do not remove any components during operation
  - Turn off control pressure, control voltage and electricity
- Display warning signs that refer to the risks involved if the system is started up unintentionally or if the electricity or line pressure is switched on
- If there is damage or a defect, switch off the affected equipment and systems
- In the case of damage of any kind, stop work on the affected equipment and systems
- After completion of work, check for correct function and if appropriate fulfill and comply with all technical guidelines
- Check that the optionally mounted accessories are functioning correctly
- All spare parts are separately produced for each ball valve. Make sure to specify nominal diameter and production number when ordering spare parts

As of: 2013-01-07  
Revision: 2013/01

Author: Franz Schuck GmbH  
Editor: bitplant.de GmbH

Codeword: XML Source: 100: Kugelhahn  
Created with: TeXML v.schuck-latex-130207

### 6.2.1 Spare parts for maintenance/repair works

	<b>DANGER</b>
	Risk of injury from bursting components/system parts!
	If the permissible limit values are exceeded, the component/system can be destroyed, and as a consequence of this persons can be injured or killed!
⇒ Always operate components/system parts within the permissible limit values!	

The safety instructions for service and maintenance works on the ball valves must be observed. To ensure the correct functioning of the ball valve, only use original spare parts and the recommended tools. This particularly applies to emergencies.

Make sure that the ball valve is depressurized, drained entirely and cooled down if applicable before removing it from the pipeline. Residues of media remaining in the ball valve and/or the dead spaces of the ball valve can be toxic, corrosive or easily inflammable. It is therefore mandatory to wear protective clothing and to clean the ball valve carefully before removing it.

All ball valves that are driven by outside energy (such as electric, pneumatic, hydraulic energy) must be deenergized before starting to work. Actuators with spring return must be released.

The required spare parts must be provided before starting the maintenance works.

	<b>DANGER</b>
	Reactive substances!
	Dead spaces may contain toxic, corrosive or inflammable substances!
⇒ Wear protective clothing!	

Some parts of the ball valves such as seals can only be used once and must be replaced by new ones during each removal.

As of: 2013-01-07  
Revision: 2013/01

Author: Franz Schuck GmbH  
Editor: bitplant.de GmbH

Codeword: XML Source: 100: Kugelhahn  
Created with: TeXML v.schuck-latex-130207

Potential spare parts are marked with \* in the table

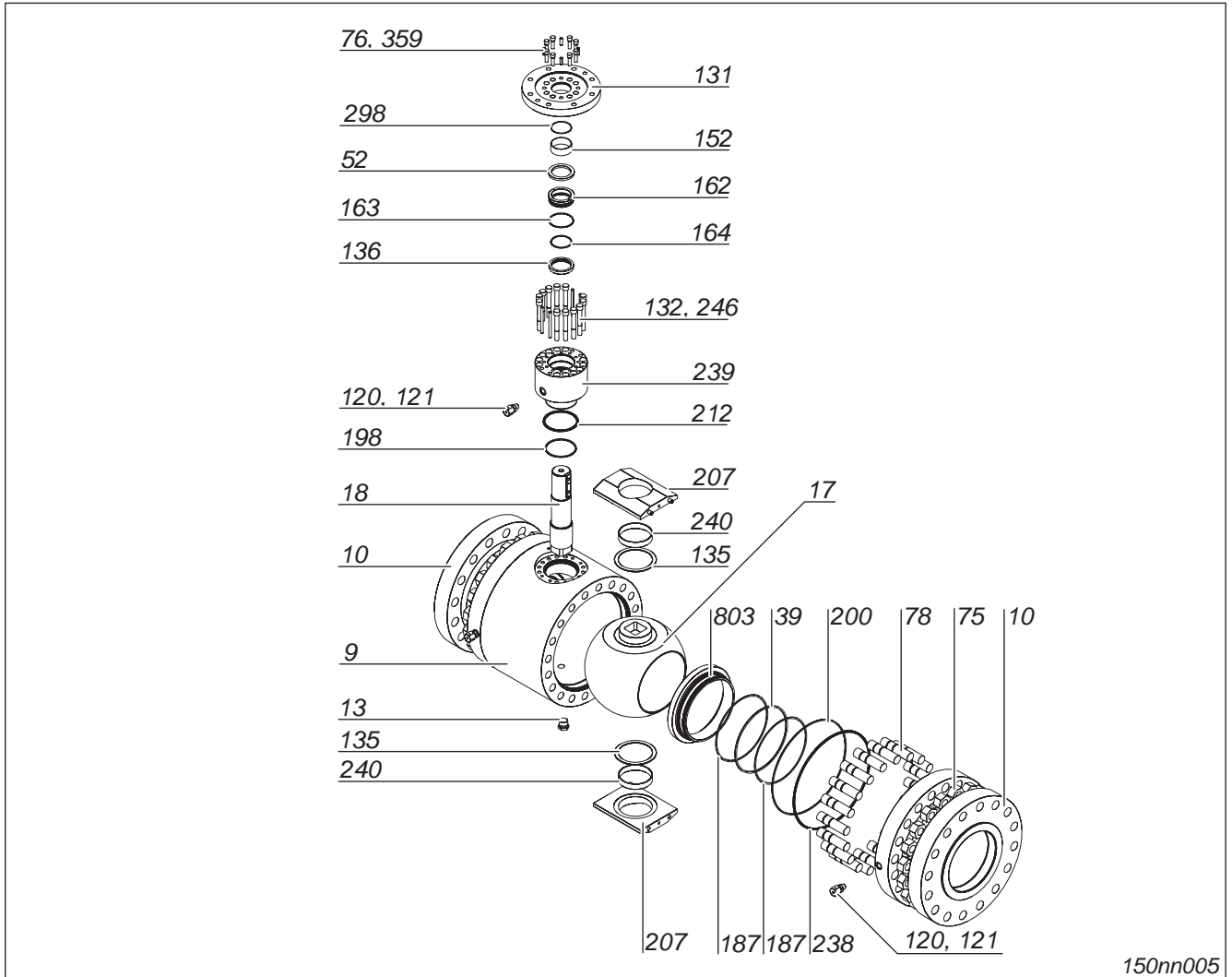

Fig. 6-1 Exploded drawing Spare parts overview

Order no. / part name	Order no. / part name	Order no. / part name	Order no. / part name
9 Housing ring	76 Cylinder head screw	152 Radial floating bearing	238* Packing ring
10 Housing flange	78 Stud screw	162 Thrust ring	239 Flanged sleeve
13 Plug	83 Identification plate	163* O-ring	240 Radial floating bearing
17 Ball plug	94 Bolt	164* O-ring	246 Bolt
18 Actuating stem	120 Injection head	187* BACK-UP-RING	298* O-ring
20 Feather key	121 Check valve	198* O-ring	357* O-ring
36 Cylinder head screw	131 Gearbox flange	200* O-ring	359 Bolt

Tab. 6-3 Exploded drawing Spare parts overview

Order no. / part name		Order no. / part name		Order no. / part name		Order no. / part name	
39*	O-ring	132	Cylinder head screw	203*	O-ring	803*	Seating ring
52	Packing ring	135	Axial bearing	207	Bearing plate	–	
75	Nut	136*	Grooved ring	212*	Packing ring	–	

Tab. 6-3 Exploded drawing Spare parts overview

## **6.2.2 Cleaning works to be carried out before reassembly**

Deposits, rust and dirt must be removed from all parts and components of the ball valve before reassembly. Especially the seat, sealing and bearing surfaces must be cleaned carefully and checked for damages. The lubricants used must be suitable and permitted for the materials, media and temperatures.

Screws/nuts must be tightened evenly and in compliance with tightening sequence (→ Page 7-1, Chapter 7.1). and tightening torques (→ Page 7-2, Chapter 7.2).

### **Completion of the works**

Before reassembling the ball valve into the pipeline, check pressure and functioning (→ Page 4-9, Chapter 4.3).

For further questions do not hesitate to contact the Franz Schuck GmbH service department.

As of: 2013-01-07  
Revision: 2013/01

Author: Franz Schuck GmbH  
Editor: bitplant.de GmbH

Codeword: XML Source: 100: Kugelhahn  
Created with: TeXML v.schuck-latex-130207

# 7 Appendix

## 7.1 Tightening sequence for flange bolts

The bolt numbers represent the order in which they should be tightened.

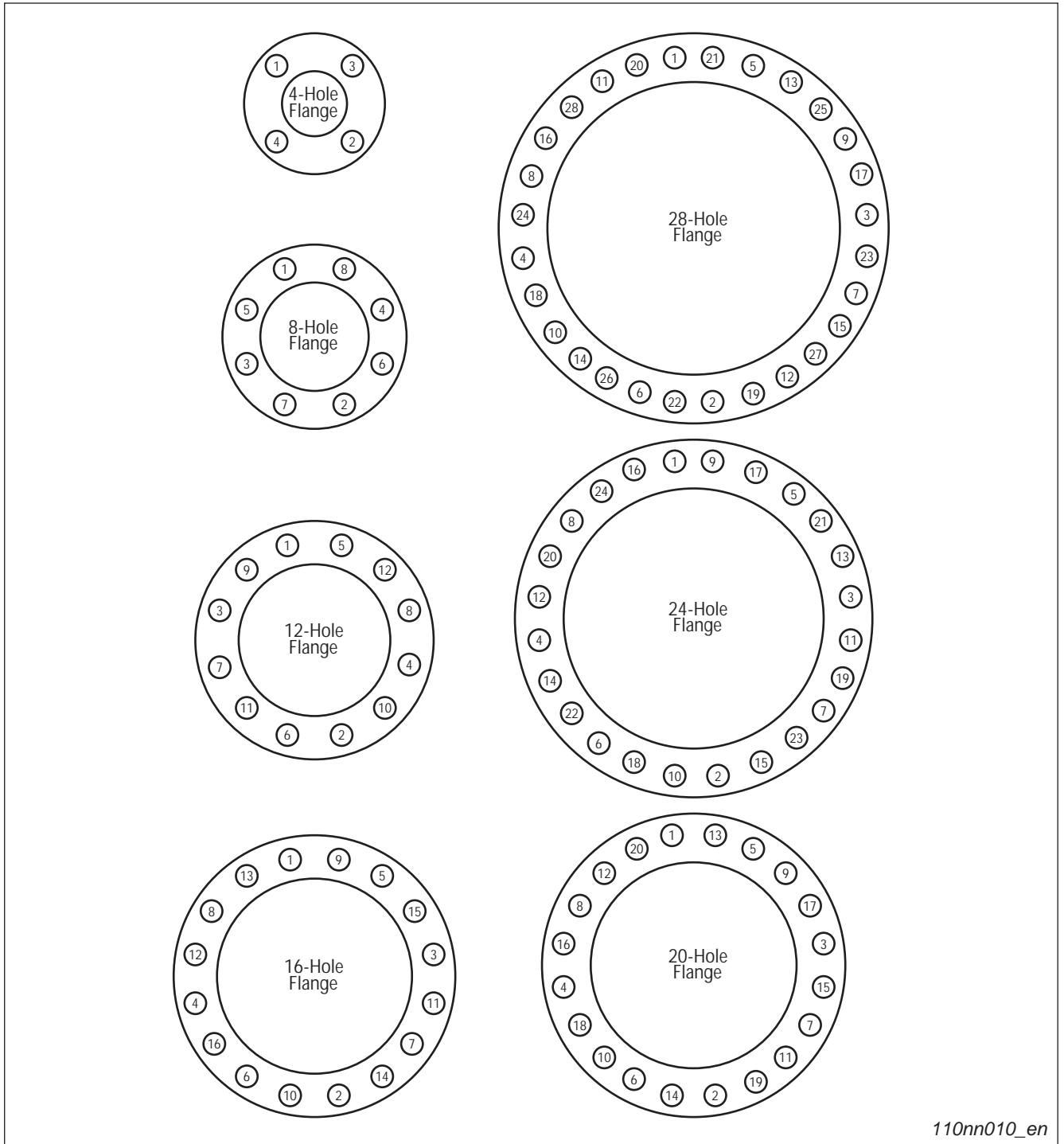

Fig. 7-1 Tightening sequence for flange bolts

110nn010\_en

As of: 2013-01-07  
Revision: 2013/01

Author: Franz Schuck GmbH  
Editor: bitplant.de GmbH

Codeword: XML Source: 100: Kugelhahn  
Created with: TeXML v.schuck-latex-130207

## 7.2 Tightening torques for housing screws

Thread diameter	Screw material B7 / L7		Screw material B7M / L7M	
	Nm	lbf-ft	Nm	lbf-ft
M10	64	47	49	36
M12	110	82	85	62
M16	270	200	205	150
M20	525	390	400	290
M24	910	670	690	510
M27	1300	980	1000	740
M30	1800	1340	1370	1010
M33	2240	1800	1850	1360
M36	3150	2320	2390	1760
M39	4050	3000	3080	2270
M42	5000	3700	3800	2800
M45	6200	4600	4750	3500
M48	7600	5600	5750	4250
M52	9700	7100	7300	5400
M56	12100	8900	9200	6700
M60	15000	11000	11300	8300
M64	18000	13300	13500	10000
M68	19600	14500	16500	12000
M72	23400	17300	19500	14500

Tab. 7-1 Tightening torques for housing screws

As of: 2013-01-07  
Revision: 2013/01

Author: Franz Schuck GmbH  
Editor: bitplant.de GmbH

Codeword: XML Source: 100: Kugelhahn  
Created with: TeXML v.schuck-latex-130207

### 7.3 Conversion factors

Value	Unit	Conversion unit	Factor
Length	mm	in	0.03934
	in	mm	25.4
	m	ft	3.28084
	ft	m	0.3048
Weight	kg	lb	2.204622
	lb	kg	0.453592
Pressure	bar	psi	14.5035
	psi	bar	0.06895
	MPa	psi	145.035
	psi	MPa	0.006895
	bar	MPa	0.1
	MPa	bar	10
Temperature	°C	°F	$1.8 \text{ } ^\circ\text{C} + 32$
	°F	°C	$(^\circ\text{F} - 32) \times 0.5556$
Volume	cm <sup>3</sup>	in <sup>3</sup> (cubic inch)	0.06102
	in <sup>3</sup> (cubic inch)	cm <sup>3</sup>	16.387
Torque	Nm	Lbf-ft	0.737562
	Lbf-ft	Nm	1.35582

Tab. 7-2 Conversion factors

As of: 2013-01-07  
Revision: 2013/01

Author: Franz Schuck GmbH  
Editor: bitplant.de GmbH

Codeword: XML Source: 100: Kugelhahn  
Created with: TeXML v.schuck-latex-130207



## 7.4 Calculation formula to determine the carbon equivalent (CEV)

To avoid an increased hardness in the weld junctions during welding, it is required to pre-heat the weld-on ends depending among others on the carbon equivalent.

### 7.4.1 Calculation formula (standard)

The calculation formula applies for steels of the following consistency:

- Carbon **C**: up to 0.22%
- Manganese **Mn**: up to 1.6%
- Chromium **Cr**: up to 1.0%
- Nickel **Ni**: up to 3.5%
- Molybdenum **Mo**: up to 0.6%
- Copper **Cu**: up to 1.0%

The calculation formula for steels of the above-mentioned consistency is:

$$CEV = C + \frac{\% Mo}{4} + \frac{\% Cr}{5} + \frac{\% Mn}{6} + \frac{\% Ni}{15} + \frac{\% P}{2} + \frac{\% Si}{4} + \frac{\% V}{5} + \frac{\% Cu}{13} \%$$

*Carbon Equivalent*

Fig. 7-2 Steel consistency and the resulting calculation formula

Adjust the pre-heat temperature on an individual basis depending on carbon equivalent, welding consumable, product gauge, hydrogen content and heat input in compliance with the welding supervisor.



The following temperature is recommended after determining the CEV value:

CEV [%]	Recommended temperature for pre-heating [°C]
≤ 0.45	up to 100 °C
0.45 – 0.60	150 – 250 °C

Tab. 7-3 Recommended temperature for pre-heating

### 7.4.2 Calculation formula for steels with different consistencies

When using steels outside the above-mentioned consistency, adjust the heat input in compliance with the welding supervisor on an individual basis.

As of: 2013-01-07  
Revision: 2013/01

Author: Franz Schuck GmbH  
Editor: bitplant.de GmbH

Codeword: XML Source: 100: Kugelhahn  
Created with: TeXML v.schuck-latex-130207

## 7.5 Sealant requirement per ball valve (above ground)

On the underground model, an additional 70 cm<sup>3</sup> of sealant is required per meter or sealant line.



NPS	DN	Sealant quantity for seats [cm <sup>3</sup> ]	Sealant quantity for trunnion [cm <sup>3</sup> ]
3	80	40	5
4	100	60	5
6	150	80	7
8	200	100	8
10	250	120	10
12	300	160	11
14	350	180	25
16	400	190	30
18	450	210	35
20	500	240	35
24	600	280	40
28	700	400	50
30	750	430	50
32	800	460	55
36	900	540	55
40	1000	610	65
44	1100	750	70
48	1200	820	80
52	1300	880	80
56	1400	960	90
60	1500	1000	100

Tab. 7-4 Sealant requirement per ball valve

As of: 2013-01-07  
Revision: 2013/01

Author: Franz Schuck GmbH  
Editor: bitplant.de GmbH

Codeword: XML Source: 100: Kugelhahn  
Created with: TeXML v.schuck-latex-130207

## 7.6 Marking of packages

### 7.6.1 Marking of packages according to DIN 55402 and ISO R 780

#### Overview

#### Marking of packages according to DIN 55402 and ISO R 780

Electrostatic sensitive device	Do NOT use fork lift truck here	Sling here	Tear off here
Use no hooks	Clamp here	This way up	Centre of gravity
Do not destroy barrier	NO hand truck here	Protect from heat and radioactive sources	Keep dry
Keep away from heat	Fragile, Handle with care	Stacking limitation	Temperature limitations

Tab. 7-5 Marking of packages according to DIN 55402 and ISO R 780

As of: 2013-01-07  
Revision: 2013/01

Author: Franz Schuck GmbH  
Editor: bitplant.de GmbH

Codeword: XML Source: 100: Kugelhahn  
Created with: TeXML v.schuck-latex-130207

## 7.6.2 Schuck symbols – transporting and unpacking packages

### Overview

#### Schuck symbols – transporting and unpacking packages

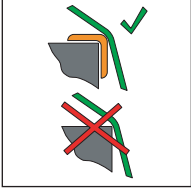
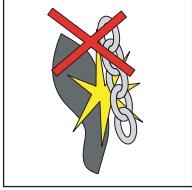
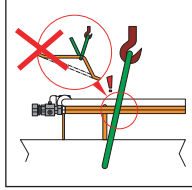
			
Use edge protectors	Do not use chains	Do not destroy pipes	

Tab. 7-6 Schuck symbols – transporting and unpacking packages

As of: 2013-01-07  
Revision: 2013/01

Author: Franz Schuck GmbH  
Editor: bitplant.de GmbH

Codeword: XML Source: 100: Kugelhahn  
Created with: TeXML v.schuck-latex-130207