

Digital pressure gauge Model CPG500

WIKA data sheet CT 09.01



for further approvals see
page 3

Applications

- Calibration service companies and service industry
- Measurement and control laboratories
- Quality assurance
- Easy on-site calibration

Special features

- Measuring ranges from -1 ... +16 bar to 0 ... 1,000 bar (-14.5 ... 230 psi to 0 ... 14,500 psi)
- Accuracy: 0.25 % (incl. calibration certificate)
- Robust case with protective rubber cap
- Simple operation using four buttons
- Complete service cases incl. pressure generation available



Digital pressure gauge model CPG500

Description

General information

The model CPG500 digital pressure gauge enables the measurement and display of pressure values in a single instrument. The accuracy of digital measurement technology and the simplicity of an analogue gauge are combined in this instrument.

Accuracy

The CPG500 offers an accuracy of 0.25 % of span in eight pressure measuring ranges. Readings can be displayed in one of five standard units.

Sampling rate

With a measuring rate of 100 measurements per second, the CPG500 features a very high measuring rate. With this, fast pressure peaks and drops in pressure can be detected. The bar graph display and drag pointer function integrated into the display, as well as retrievable MIN/MAX peak values, enable effective analysis of the measuring point.

Features

In order to prolong the battery life, the CPG500 features an automatic switch-off function. With the ZERO function, the display value can be zeroed with the simple press of a button. An activatable filter function stabilises pressures which fluctuate strongly, and enables the pressure value to be read easily.

Complete test and service cases

For maintenance and service applications, various case systems are available. Service cases with pneumatic or hydraulic pressure generation are available.

Certified accuracy

For each digital pressure gauge, the accuracy is certified by a factory calibration certificate which accompanies the instrument. On request, a DKD/DAkkS calibration certificate will be provided for this instrument.

Specifications

Model CPG500







Sensor technology				
Measuring range	-1 ... +16 bar			
Resolution	0.001			
Measuring range	-1 ... +20 bar	-1 ... +40 bar	0 ... 60 bar	0 ... 100 bar
Resolution	0.01			
Measuring range	0 ... 350 bar	0 ... 700 bar	0 ... 1,000 bar	
Resolution	0.1			
Measuring range	-14,5 ... 230 psi			
Resolution	0.001			
Measuring range	-14,5 ... 290 psi	-14,5 ... 580 psi	0 ... 870 psi	0 ... 1,540 psi
Resolution	0.01			
Measuring range	0 ... 5,000 psi	0 ... 10,000 psi	0 ... 14,500 psi	
Resolution	0.1			
Overload safety	3 times; < 25 bar (< 360 psi) 2 times; > 25 bar ... ≤ 600 bar (> 360 psi ... ≤ 8,700 psi) 1.5 times; > 600 bar (> 8,700 psi)			
Pressure connection	G ¼ up to a max. 40 bar (580 psi) G ½ from > 40 bar (> 580 psi)			
Accuracy	0.25 % FS ±1 digit			

Base instrument	
Indicator	
Display	4 ½ digit, bar graph with drag pointer function, illuminated
Digit height	15 mm (0.59 in)
Rotatable case	> 270 °
Dimensions	50 x 34 mm (1.97 x 1.34 in)
Pressure units	bar, psi, MPa, kPa, kg/cm ²
Functions	
Measuring rate	10 ms
Memory	MIN/MAX
Autopower	Selectable
Zero function	Zero point adjustment
Reset	Delete MIN/MAX value
Material	
Wetted parts ¹⁾	Stainless steel with sealing NBR
Case	Die-cast zinc with TPE protective rubber cap
Voltage supply	
Power supply	2 x 1.5 V AA batteries
Battery life	approx. 1,500 hrs.
Battery status display	Icon in display
Permissible ambient conditions	
Operating temperature	-10 ... +50 °C (14 ... 122 °F)
Medium temperature	-20 ... +80 °C (-4 ... +176 °F)
Storage temperature	-20 ... +60 °C (-4 ... +140 °F)
Relative humidity	< 85 % r. h. (non-condensing)

1) Only for use with safe media per directive 67/548/EEC (article 2, paragraph 2).

Base instrument	
Case	
Dimensions	79 x 79 x 33 mm (3.11 x 3.11 x 1.30 in)
Ingress protection	IP67
Weight	approx. 400 g (0.882 lbs)

Approvals

Logo	Description	Country
	EU declaration of conformity <ul style="list-style-type: none"> ■ EMC directive EN 61326 emission (group 1, class B) and interference immunity (industrial application) ■ Pressure equipment directive ■ RoHS conformity 	European Union
	EAC <ul style="list-style-type: none"> ■ EMC directive ■ Pressure equipment directive 	Eurasian Economic Community
-	MTSCHS Permission for commissioning	Kazakhstan
	KazInMetr Metrology, measurement technology	Kazakhstan
	BelGIM Metrology, measurement technology	Belarus
	UkrSEPRO Metrology, measurement technology	Ukraine
	Uzstandard Metrology, measurement technology	Uzbekistan

Certificates

Certificate	
Calibration	Standard: 3.1 calibration certificate per DIN EN 10204 Option: DKD/DAkkS calibration certificate
Recommended recalibration interval	1 year (dependent on conditions of use)

Approvals and certificates, see website

Dimensions in mm (in)

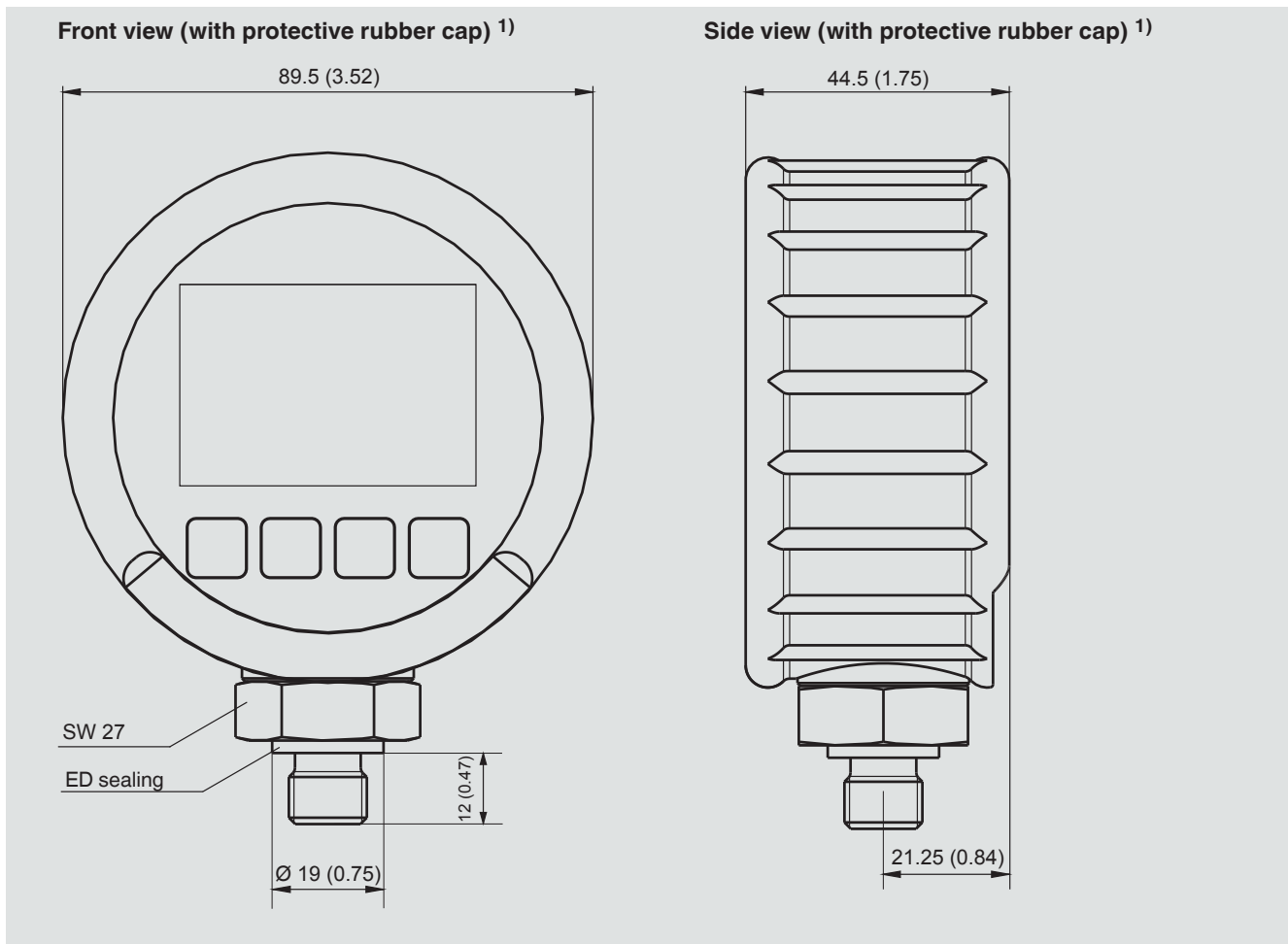

1) Drawing with G ¼ pressure connection

Front foil

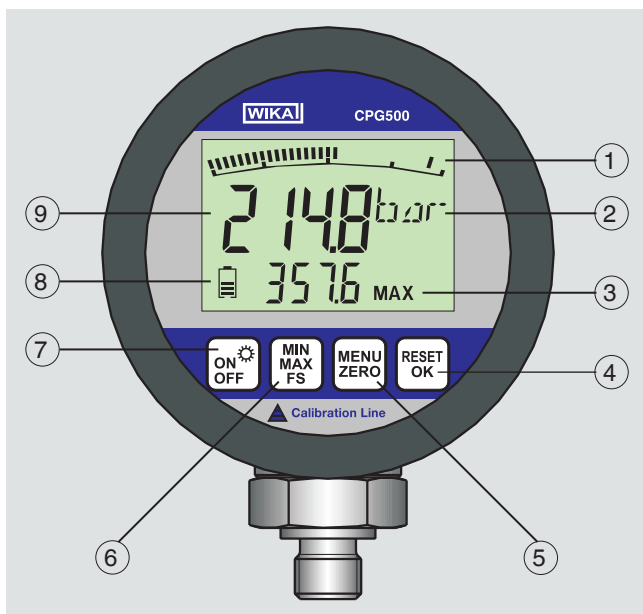

- ① Bar graph indicates the current pressure graphically
- ② Currently set unit
- ③ Display of the measuring range or the MIN/MAX value
- ④ Clear the MIN/MAX values
Confirmation function in the menu
- ⑤ Hold down to access the menu
Zero point adjustment carried out by simply pressing
- ⑥ Change display value to MIN/MAX or FS (Full Scale)
- ⑦ With a single press, switch the digital pressure gauge on/off
Press for a while in order to switch the backlighting on
- ⑧ Battery status
- ⑨ Pressure indication

Complete test and service cases



Basic version incl. pneumatic pressure generation

Calibration case with model CPG500 digital pressure gauge and model CPP40 hand test pump, for pressures -0.95 ... +40 bar (13.8 ... 580 psi), consisting of:

- Plastic service case with foam insert
- Digital pressure gauge model CPG500
- Pneumatic hand test pump model CPP40; -0.95 ... +40 bar (13.8 ... 580 psi)

Available measuring ranges see specifications



Basic version incl. hydraulic pressure generation

Calibration case with model CPG500 digital pressure gauge and model CPP700-H or CPP1000-H hand test pumps, for pressures 0 ... 700 bar (0 ... 10,000 psi) or 0 ... 1,000 bar (0 ... 14,500 psi), consisting of:

- Plastic service case with foam insert
- Digital pressure gauge model CPG500
- Hydraulic hand test pump model CPP700-H or CPP1000-H, 0 ... 700 bar (0 ... 10,000 psi) or 0 ... 1,000 bar (0 ... 14,500 psi)

Available measuring ranges see specifications

Recommended pressure generation

Pneumatic hand test pump model CPP40

Pressure range: -0.95 ... +40 bar (13.8 ... 580 psi)



Model CPP700-H or model CPP1000-H hydraulic hand test pumps

Pressure range: 0 ... 700 bar or 0 ... 1,000 bar
(0 ... 10,000 psi or 0 ... 14,500 psi)

Further specifications see data sheet CT 91.07

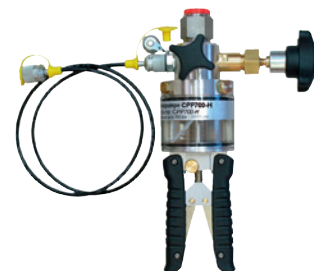

Scope of delivery

- Digital pressure gauge model CPG500
- Operating instructions
- 3.1 calibration certificate per DIN EN 10204
- 2 x AA batteries
- Protective rubber cap for case

Option

- DKD/DAkkS certified accuracy

Accessories

Connection adapters

- Various pressure adapters

Pressure generation

- Pneumatic test pumps
- Hydraulic test pumps

Test case

- Various calibration cases incl. pressure generation

Ordering information

Model / Unit / Measuring range / Process connection / Test pump / Transport case / Type of certificate / Further approvals / Additional ordering information