

Hand-held thermometer, precision version Model CTH6500 Model CTH6510, explosion-protected version

WIKA data sheet CT 55.10



for further approvals
see page 4

Applications

- Calibration of thermometers
- Temperature measurement for the purposes of quality assurance
- Measurements in service and maintenance applications
- Long-term monitoring and online documentation

Special features

- High accuracy of 0.03 K with Pt100
- One- and two-channel versions
- Connection possibility for various probe types
- Intrinsically safe version, Ex ib IIB T4 Gb



Hand-held thermometer model CTH6500

Description

The all-purpose model CTH6500 hand-held thermometer, for superior mobile temperature measurement, is notable for its precision, flexibility and ease of handling.

In addition to Pt100 resistance thermometers, it can also process signals from typical thermocouples. Thus temperatures from -200 ... +1,500 °C [-328 ... +2,732 °F] can be measured. The explosion-protected version is only available for Pt100 resistance thermometers.

Through its high accuracy of 0.03 K in ranges from -100 ... +150 °C [-148 ... +302 °F], this instrument can also be used as a reference instrument in biotechnology, pharmaceutical and food industries. The CTH6500 is thus ideal for all service and maintenance tasks.

Low-drift measuring amplifiers ensure small measurement errors, while easy-to-use adjustment features considerably simplify adjustments and calibrations:

- Calibration by code for fast setting of standard probes via key data

- Physical calibration of probe and display at one, two or three different temperatures

In this way it is possible to reduce measuring errors to a minimum and ensure a high indication accuracy.

Additional fields of application

The instrument has been primarily designed for temperature measurement, though it can, with the appropriate probes, also be used for:

- Humidity measurement with a combined temperature-humidity probe
- Flow measurement from 0.1 ... 40 m/s with a vane sensor

The calibration and adjustment possibilities above are also applicable to these measurands.

Complete test and service cases

For the secure transportation and storage of the instrument and accessories, a rugged service case is available as a sensible addition. The service case can carry one model CTH6500 digital indicator and several temperature probes.

Certified accuracy

For each temperature probe, the accuracy for the complete measuring chain is certified by a factory calibration certificate which accompanies the instrument. On request, we can provide a DKD/DAkkS calibration certificate for this instrument.

Specifications

Hand-held thermometer	Model CTH6500	Model CTH6510
Probe types	Pt100, thermocouples, humidity, flow	Pt100
Measuring inputs	1 or 2	1 or 2
Measuring ranges		
Pt100	-200 ... +600 °C [-328 ... +1,112 °F]	-200 ... +600 °C [-328 ... +1,112 °F]
Thermocouples	-200 ... +1,500 °C [-328 ... + 2,732 °F]	-
Humidity	0 ... 100 % r. h.	
Flow	0 ... 40 m/s	
Accuracies		
Resistance thermometer type Pt100	0.03 K of -50 ... +199.99 °C [-58 ... +394.98 °F] 0.05 K of -200 ... -50.01 °C [-328 ... -58.02 °F] otherwise 0.05 % of reading	0.03 K of -50 ... +199.99 °C [-58 ... +394.98 °F] 0.05 K of -200 ... -50.01 °C [-328 ... -58.02 °F] otherwise 0.05 % of reading
Thermocouple types K, J, L, N and T	0.2 K of 0 ... 200 °C [32 ... 392 °F] 0.5 K of 200 ... 1,000 °C [392 ... 1,832 °F] 1 K above 1,000 °C [1,832 °F]	-
Thermocouple types R and S	1 K + 0.1 % of reading	-
Humidity	1.5 % r. h.	
Flow	0.5 % of end value	

Digital indicator	
Indication	
Display	Large 4 1/2-digit LC display with backlighting, for the display of two temperature values and additional information
Resolution	0.01 K up to 200 °C [392 °F], then 0.1 K
Indication range	-19999 ... 19999
Functions	
Measuring rate	Measuring rate (can be set via menu) ■ 1/s ("slow" - slow measurement) ■ 4/s ("fast" - fast measurement)
Real-time clock	integrated clock with date
Min./Max. memory	Minimum or maximum measured value (can be accessed via function key)
Hold	Holding the last measured value (can be accessed via function key)
Zero point adjustment	Tare or zero point adjustment can be accessed via function key
Voltage supply	
Supply voltage	■ 9 V battery ■ 9 V rechargeable battery or mains supply (not permissible for CTH6510)
Battery life	approx. 20 hours of operation with battery

Digital indicator	
Permissible ambient conditions	
Ambient temperature	0 ... 40 °C [32 ... 104 °F]
Storage temperature	-10 ... +50 °C [14 ... 122 °F]
Relative humidity	0 ... 95 % r. h. (non-condensing)
Communication	
Serial interface	USB via interface cable
Case	
Material	impact-resistant ABS plastic, transparent screen
Dimensions (L x W x H)	200 x 93 x 44 mm [7.87 x 3.66 x 1.73 in]
Weight	350 g [0.77 lbs.] (incl. battery)







Temperature probe

Immersion probe	
Measuring element	Temperature range
Pt100	<ul style="list-style-type: none"> ■ -200 ... +450 °C [-328 ... +842 °F] ■ -40 ... +500 °C [-40 ... +932 °F]
Type K	-100 ... +1,100 °C [-148 ... +2,012 °F]
Sensor dimensions	
Pt100	<ul style="list-style-type: none"> ■ d = 3 mm, l = 150 mm [d = 0.12 in, l = 5.91 in] ■ d = 3 mm, l = 300 mm [d = 0.12 in, l = 11.81 in] ■ d = 3 mm, l = 1,000 mm [d = 0.16 in, l = 39.37 in] ■ d = 4 mm, l = 300 mm [d = 0.16 in, l = 11.81 in] ■ d = 6 mm, l = 300 mm [d = 0.24 in, l = 11.81 in]
TC K	<ul style="list-style-type: none"> ■ d = 3 mm, l = 300 mm [d = 0.12 in, l = 11.81 in] ■ d = 3 mm, l = 500 mm [d = 0.12 in, l = 19.69 in]
Sensor cable	
Cable length	1,000 mm
Cable material	PVC
Connection to CTH65x0	8-pin, DIN circular connector
Dimensions (L x W x H)	see technical drawing

Surface probe	
Measuring element	Type K
Temperature range	-40 ... +900 °C [-40 ... +1,652 °F]
Sensor dimensions	d = 3 mm, l = 150 mm [d = 0.12 in, l = 5.91 in] Spring with thermocouple strip
Sensor cable	
Cable length	1,000 mm
Cable material	PVC
Connection to CTH6500	8-pin, DIN circular connector

Combined temperature-humidity probe	
Temperature range	-30 ... +80 °C [-22 ... +176 °F]
Humidity	0 ... 100 % r. h.
Sensor dimensions	d = 20 mm, l = 120 mm [d = 0.79 in, l = 4.72 in]
Sensor cable	
Cable length	1,000 mm
Cable material	PVC/PVC
Connection to CTH6500	8-pin, DIN circular connector

Approvals

Logo	Description	Country
	EU declaration of conformity for the CTH6500 <ul style="list-style-type: none"> ■ EMC directive EN 61326 emission (group 1, class B) and immunity (portable test and measuring equipment) ■ RoHS directive 	European Union
	EU declaration of conformity for the CTH6510 <ul style="list-style-type: none"> ■ EMC directive EN 61326 emission (group 1, class B) and immunity (portable test and measuring equipment) ■ RoHS directive ■ ATEX directive - Ex i Zone 1 gas II 2G Ex ib IIB T4 Gb T4 at 0 ... 40 °C 	European Union
		
	EAC (option) EMC directive	Eurasian Economic Community
	GOST (option) Metrology, measurement technology	Russia
-	MTSCHS (option) Permission for commissioning	Kazakhstan
	KazInMetr (option) Metrology, measurement technology	Kazakhstan
	UkrSEPRO (option) Metrology, measurement technology	Ukraine

Certificates

Certificate	
Calibration	Standard: 3.1 calibration certificate per DIN EN 10204 Option: DKD/DAkkS calibration certificate
Recommended recalibration interval	1 year (dependent on conditions of use)

Approvals and certificates, see website

Dimensions in mm [in]

Hand-held thermometer, models CTH6500 and CTH6510 as explosion-protected version

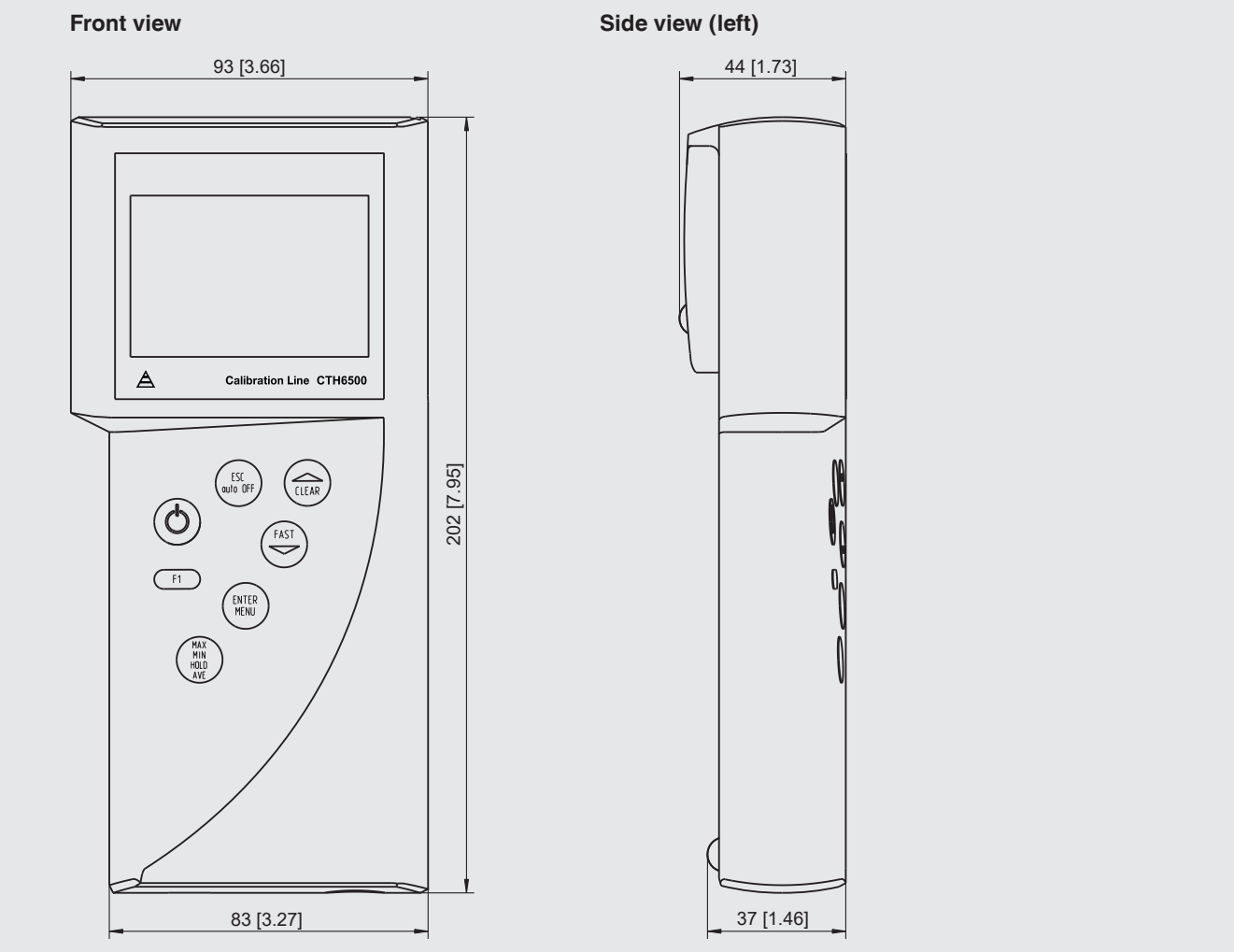

Temperature probe, immersion probe

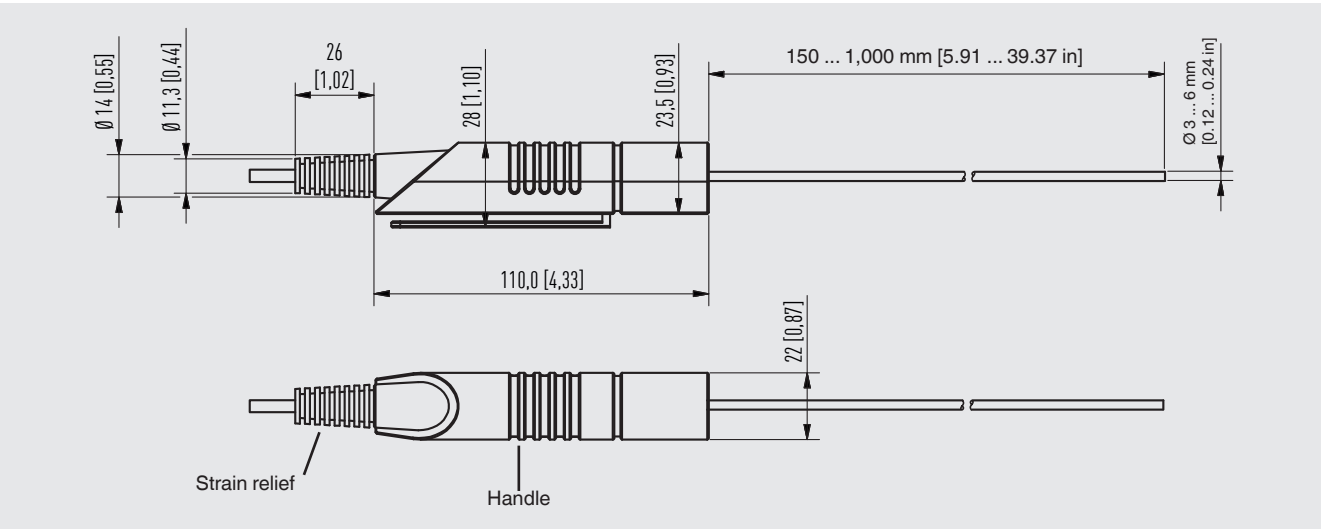

Electrical connections

Model CTH65x0 (1-channel instrument)

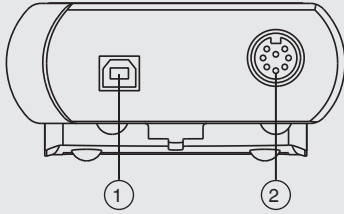

Model CTH65x0 (2-channel instrument)

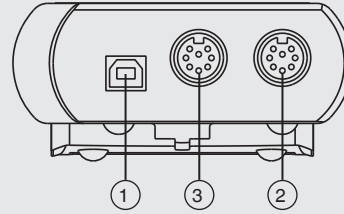

- ① Connection USB interface
- ② Connection temperature probe 1 (only for CTH6500 or CTH6510 with one connection)
- ③ Connection temperature probe 2 (only for CTH6500 or CTH6510 with two connections)

Features of the hand-held thermometer

- Easy handling
- Large display with dual temperature display and bar graph
- Min./Max. value for monitoring of temperature limits
- Mean value function for statistical evaluation
- “Fast mode” for faster measurements up to 4/s
- Selectable channel can be switched off to improve the clarity of the display data
- Recording and visualisation of temperature cycles with the help of the DE-Graph software
- Data logger (optional)

- ① Probe holder
- ② First connection port for temperature probe
- ③ Second connection port for temperature probe
- ④ USB connection port for PC
- ⑤ Keyboard
- ⑥ Large LC display



Operation

In the **SETUP** menu, a menu point can be selected and altered using the **UP** and **DOWN** keys. **ENTER** and **ESC** are used for confirmation and exit.

The operating menu is intuitively understandable and is subdivided into only two levels:

Main menu for the selection of the basic functions and parameter menu for setting the parameters.

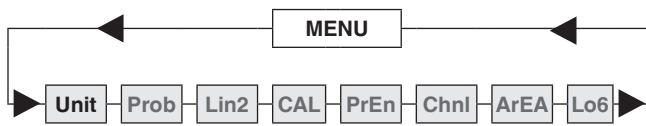

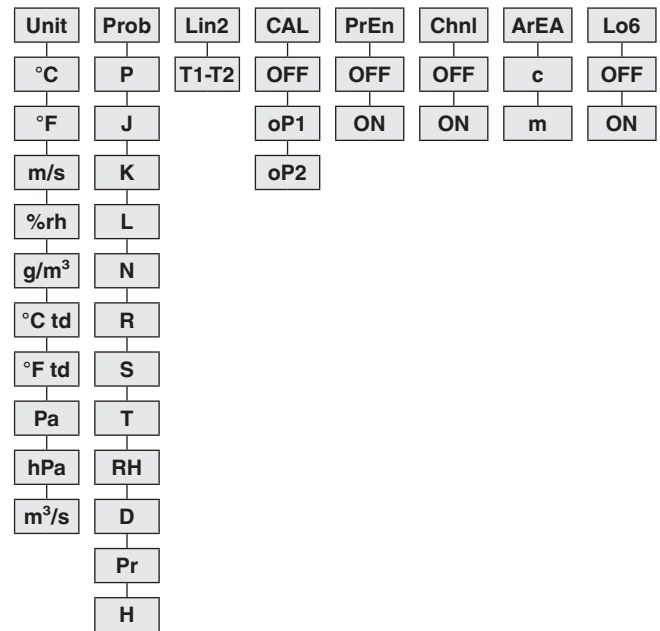

Main menu for CTH6500







Parameter menu for CTH6500



Accessories



Accessories for CTH6500		Order code
Description		CTX-A-H4
	Immersion probe Type Pt100 Dimensions: d = 3 mm, l = 150 mm [d = 0.12 in, l = 5.91 in] Temperature range: -200 ... +450 °C [-328 ... +842 °F]	-10-
	Type Pt100 Dimensions: d = 3 mm, l = 300 mm [d = 0.12 in, l = 11.81 in] Temperature range: -200 ... +450 °C [-328 ... +842 °F]	-20-
	Type Pt100 Dimensions: d = 4 mm, l = 300 mm [d = 0.16 in, l = 11.81 in] Temperature range: -40 ... +500 °C [-40 ... +932 °F]	-40-
	Type Pt100 Dimensions: d = 6 mm, l = 300 mm [d = 0.24 in, l = 11.81 in] Temperature range: -200 ... +450 °C [-328 ... +842 °F]	-45-
	Type K Dimensions: d = 3 mm, l = 300 mm [d = 0.12 in, l = 11.81 in] Temperature range: -100 ... +1,100 °C [-148 ... +2,012 °F]	-50-
	Type K Dimensions: d = 3 mm, l = 500 mm [d = 0.12 in, l = 19.69 in] Temperature range: -100 ... +1,100 °C [-148 ... +2,012 °F]	-60-
	Surface probe Type K Spring with thermocouple strip Temperature range: -40 ... +900 °C [-40 ... +1,652 °F]	-SU-

Accessories for CTH6500		Order code
Description		CTX-A-H4
	Combined humidity-temperature probe Dimensions: d = 20 mm, l = 120 mm [d = 0.79 in, l = 4.72 in] Humidity range: 0 ... 100 % rh Temperature range: -30 ... +80 °C [-22 ... +176 °F]	-FT-
	Adapters for thermocouples DIN to TC miniature connector	-AD-
	Spare DIN connector for the probe	-CN-
	Case set Consisting of: <ul style="list-style-type: none"> ■ Transport case, robust ■ 9 V battery ■ Interface cable ■ Software 	-CR-
	Case set Consisting of: <ul style="list-style-type: none"> ■ Transport case, robust ■ 9 V rechargeable battery and charger ■ Power supply unit ■ Interface cable ■ Software V2 	-CS-
	Case set Consisting of: <ul style="list-style-type: none"> ■ Transport case, robust ■ Power supply unit AC 100 ... 260 V ■ Interface cable ■ Software V2 	-CU-
	Service case with foam insert Material: Plastic	-SC-
	Protective bag against dirt and humidity Material: Plastic	-PS-
	9 V battery	-DB-
	9 V rechargeable battery	-RB-
	Battery charger for 9 V rechargeable batteries	-AC-
	AC adapter AC 100 ... 260 V, 50/60 Hz	-P1-
	AC adapter AC 230 V, 50/60 Hz	-P2-

Accessories for CTH6500		Order code
Description		CTX-A-H4
	USB interface cable	-UB-
	Calibration software DE-Graph software for Windows	-SG-
Ordering information for your enquiry:		
1. Order code: CPX-A-H4 2. Option:		↓ []

Accessories for CTH6510, explosion-protected version		Order code
Description		CTX-A-H5
	Immersion probe Type Pt100 Dimensions: d = 3 mm, l = 150 mm [d = 0.12 in, l = 5.91 in] Temperature range: -200 ... +450 °C [-328 ... +842 °F]	-10-
	Suitable for hazardous areas. Type Pt100 Dimensions: d = 3 mm, l = 300 mm [d = 0.12 in, l = 11.81 in] Temperature range: -200 ... +450 °C [-328 ... +842 °F]	-20-
	Suitable for hazardous areas. Type Pt100 Dimensions: d = 4 mm, l = 300 mm [d = 0.16 in, l = 11.81 in] Temperature range: -40 ... +500 °C [-40 ... +932 °F]	-40-
	Suitable for hazardous areas. Type Pt100 Dimensions: d = 6 mm, l = 300 mm [d = 0.24 in, l = 11.81 in] Temperature range: -200 ... +450 °C [-328 ... +842 °F]	-45-
	Suitable for hazardous areas.	
	Spare DIN connector for the probe	-CN-
	Case set Consisting of: ■ Transport case, robust ■ 9 V battery ■ Interface cable ■ Software ⚠ May not be used in Ex areas!	-CR-
	Service case with foam insert Material: Plastic	-SC-
	Protective bag against dirt and humidity Material: Plastic	-PS-

Accessories for CTH6510, explosion-protected version		Order code
Description		CTX-A-H5
	9 V battery	-DB-
	USB interface cable ⚠ May not be used in Ex areas!	-UB-
	Calibration software DE-Graph software for Windows	-SG-
Ordering information for your enquiry:		
1. Order code: CPX-A-H5 2. Option:		↓ []

Other probes are available on request	
	Penetration probe
	Vane flow probe
	Customer-specific probes

Scope of delivery

- Hand-held thermometer model CTH6500 or intrinsically safe hand-held thermometer model CTH6510
- 9 V battery
- 3.1 calibration certificate per DIN EN 10204
- Choice of temperature probes

Option

- DKD/DAkkS calibration certificate



**Intrinsically safe hand-held thermometer,
model CTH6510**

Ordering information

Model / Version / Data logger / Probe at input 1 / Probe at input 2 / Case set / Calibration / Test points for calibration certificate /
Number of test points / Further approvals / Additional ordering information

© 04/2013 WIKA Alexander Wiegand SE & Co. KG, all rights reserved.
The specifications given in this document represent the state of engineering at the time of publishing.
We reserve the right to make modifications to the specifications and materials.