

Level sensor

For industrial applications, stainless steel version

Model RLT-1000

WIKA data sheet LM 50.02

Applications

- Level measurement of liquids in machine building
- Control and monitoring tasks for hydraulic power packs, compressors and cooling systems.

Special features

- Media compatibility: Oil, water, diesel, refrigerants and other liquids
- Permissible medium temperature range: -30 ... +120 °C [-22 ... +248 °F]
- Output signal: Resistance in a 3-wire potentiometer circuit, current output 4 ... 20 mA
- Measuring principle: Reed-chain technology
- Accuracy, resolution: 24 mm [0.9 in], 12 mm [0.5 in], 10 mm [0.4 in], 6 mm [0.2 in] or 3 mm [0.1 in]

Description

The model RLT-1000 level sensor has been developed for measuring the levels of liquids. The stainless steel used is suitable for a multitude of media, such as, for example, oil, water, diesel and refrigerants.

Measuring principle

A permanent magnet built into the float triggers, with its magnetic field, the resistance measuring chain built into the guide tube. The entire assembly corresponds to a 3-wire potentiometer circuit. The measured resistance signal is proportional to the level. The model RLT-1000 is optionally available with a 4 ... 20 mA analogue output.



Fig. left: Mounting thread, angular connector

Fig. right: Mounting thread, circular connector M12 x 1

Specifications

Level sensor, model RLT-1000	
Measuring principle	Reed-chain technology with optional analogue amplifier
Measuring range M	The measuring range is determined from the selected guide tube length L and the position of the 100 % mark. For dimensions see drawing
Guide tube length L	150 ... 1,500 mm [6 ... 59 in], greater lengths on request
Output signal	<ul style="list-style-type: none"> ■ Variable resistance The overall resistance of the reed chain is approx. 1 ... 10 kΩ, depending on the measuring range Max. voltage < DC 40 V ■ Current output, 4 ... 20 mA, 2-wire Power supply: DC 12 ... 32 V Load in Ω: ≤ (power supply - 12 V) / 0.02 A
Accuracy, resolution	<ul style="list-style-type: none"> ■ 24 mm [0.9 in] ¹⁾ ■ 12 mm [0.5 in] ²⁾ ■ 10 mm [0.4 in] ³⁾ ■ 6 mm [0.2 in] ²⁾ ■ 3 mm [0.1 in] ²⁾
Mounting position	Vertical ±30°
Process connection	<ul style="list-style-type: none"> ■ G 1, installation from outside ■ G 1 ½, installation from outside ■ G 2, installation from outside ■ Flange DN 50, form B per DIN 2527/EN 1092, PN 16, installation from outside ■ G ¾, installation from inside ⁴⁾ ■ G ½, installation from inside ⁴⁾ ■ G ¼, installation from inside ⁴⁾
Material	<ul style="list-style-type: none"> ■ Wetted ■ Non-wetted Process connection, guide tube: Stainless steel 1.4571 (316Ti) Float: See table on page 3 Case: Stainless steel 1.4571 (316Ti) Electrical connection: See table below
Permissible temperatures	<ul style="list-style-type: none"> ■ Medium ■ Ambient ■ Storage -30 ... +80 °C [-22 ... +176 °F], option: -30 ... +120 °C [-22 ... +248 °F] ⁵⁾ -30 ... +80 °C [-22 ... +176 °F] -30 ... +80 °C [-22 ... +176 °F]

Electrical connections ⁶⁾	Ingress protection ⁷⁾	Material	Cable length
Angular connector DIN 175301-803 A	IP65	PA	-
Circular connector M12 x 1 (4-pin)	IP65	TPU, brass	
Cable outlet	IP67	PVC	■ 2 m [6.5 ft]
Cable outlet	IP67	PUR	■ 5 m [16.4 ft]
Cable outlet	IP67	Silicone	other lengths on request
Connection housing "standard" Dimensions: 75 x 80 x 57 mm [3.0 x 3.1 x 2.2 in] For cable diameter: 5 ... 10 mm [0.2 ... 0.4 in]	IP66	Aluminium, glands from polyamide, brass, stainless steel	-
Connection housing „compact“ Dimensions: 58 x 64 x 36 mm [2.3 x 2.5 x 1.4 in] For cable diameter: 5 ... 10 mm [0.2 ... 0.4 in]	IP66		

1) Not with float diameter 30 mm [1.2 in] or 25 mm [1.0 in]

2) Not with float diameter 30 mm [1.2 in]

3) Only with float diameter 30 mm [1.2 in]

4) Only with cable outlets

5) Not with cable material: PVC, PUR; float outer diameter Ø D = 30 mm [1.2 in]; not with connection housing 58 x 64 x 36 mm [2.3 x 2.5 x 1.4 in]

6) Cable outlets not available with current output 4 ... 20 mA

7) The stated ingress protection (per IEC/EN 60529) only applies when plugged in using mating connectors that have the appropriate ingress protection.

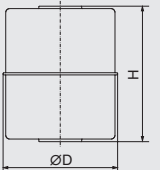
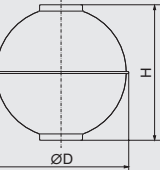
Float	Form	Outer diameter Ø D	Height H	Operating pressure	Medium temperature	Density	Material
	Cylinder ¹⁾	44 mm [1.7 in]	52 mm [2.0 in]	≤ 16 bar [≤ 232 psi]	≤ 120 °C [≤ 248 °F]	≥ 750 kg/m ³ [46.8 lbs/ft ³]	1.4571 (316Ti)
	Cylinder ²⁾	30 mm [1.2 in]	36 mm [1.4 in]	≤ 10 bar [≤ 145 psi]	≤ 80 °C [≤ 176 °F]	≥ 850 kg/m ³ [53.1 lbs/ft ³]	1.4571 (316Ti)
	Cylinder	25 mm [1.0 in]	20 mm [0.8 in]	≤ 16 bar [≤ 232 psi]	≤ 80 °C [≤ 176 °F]	≥ 750 kg/m ³ [46.8 lbs/ft ³]	Buna / NBR
	Sphere ³⁾	52 mm [2.0 in]	52 mm [2.0 in]	≤ 40 bar [≤ 580 psi]	≤ 120 °C [≤ 248 °F]	≥ 750 kg/m ³ [46.8 lbs/ft ³]	1.4571 (316Ti)

1) Not with process connection G 1

2) Only with guide tube length ≤ 1,000 mm [39.4 in]

3) Not with process connection G 1, G 1 ½

Connection diagram

Angular connector DIN 175301-803 A				
	Variable resistance		Current output, 4 ... 20 mA, 2-wire	
	Overall resistance	Pin 2 / 3	U ₊	Pin 1
	100 ... 0 %	Pin 1 / 3	U ₋	Pin 2
	0 ... 100 %	Pin 1 / 2		

Circular connector M12 x 1 (4-pin)				
	Variable resistance		Current output, 4 ... 20 mA, 2-wire	
	Overall resistance	Pin 3 / 4	U ₊	Pin 1
	100 ... 0 %	Pin 1 / 3	U ₋	Pin 4
	0 ... 100 %	Pin 1 / 4		

Cable outlet			
	Variable resistance		
	Overall resistance	green / white	
	100 ... 0 %	white / brown	
	0 ... 100 %	brown / green	

Aluminium case				
	Variable resistance		Current output, 4 ... 20 mA, 2-wire	
	Overall resistance	Terminal W1 / W3	U ₊	Terminal U ₊
	100 ... 0 %	Terminal W1 / W2	U ₋	Terminal U ₋
	0 ... 100 %	Terminal W2 / W3		

Electrical safety

Reverse polarity protection	U+ vs. U-
Insulation voltage	DC 1,500 V
Overvoltage protection	DC 40 V

Dimensions in mm [in]

with angular connector form A
Resistance signal

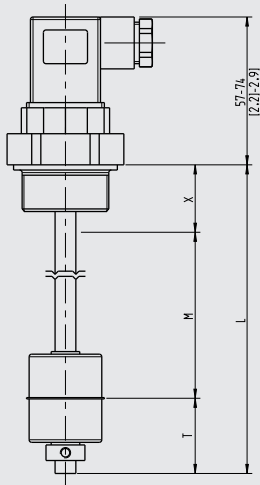

with angular connector form A
Current output 4 ... 20 mA

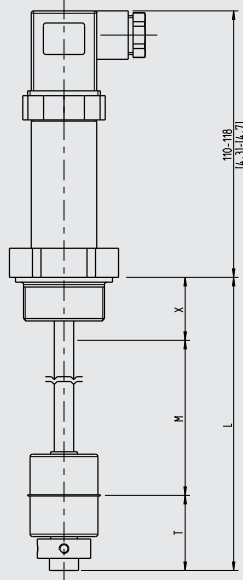

with connection housing

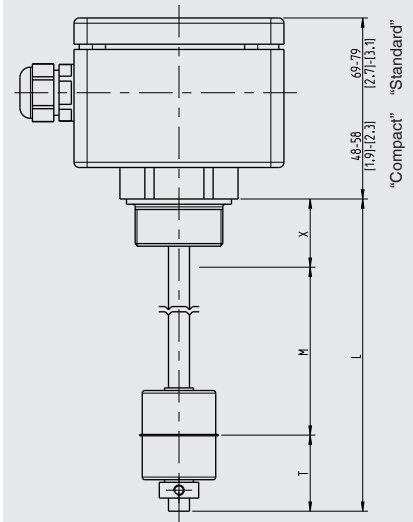

with M12 x 1 circular connector
Resistance signal

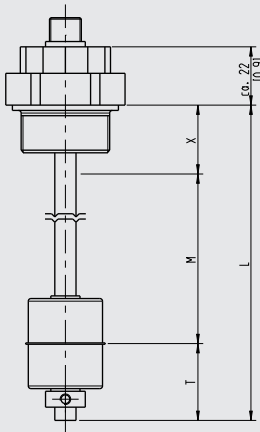

with M12 x 1 circular connector
Current output 4 ... 20 mA

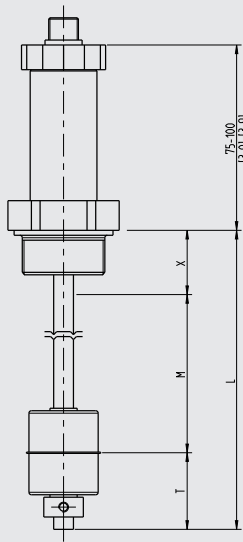

with cable outlet
Resistance signal

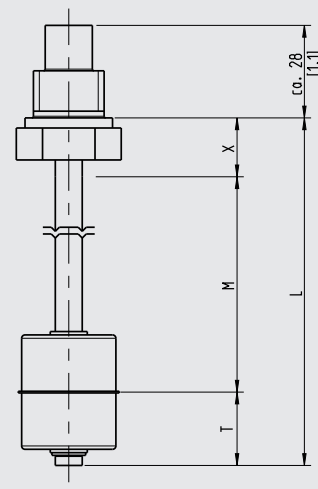

Legend

- L Guide tube length
- M Measuring range
- X Distance sealing face to 100 % mark
($X \geq$ dead band T in mm [in] (from sealing edge))
- T Dead band (pipe end)

Float stop at guide tube end

- Adjusting collar, for medium temperature $\leq 80\text{ °C}$ [$\leq 176\text{ °F}$]
- Pipe clamp, for medium temperature $> 80\text{ °C}$ [$> 176\text{ °F}$]

Dead band T float switch in mm [in] (from sealing edge)

Process connection	Outer diameter float \varnothing D			
	\varnothing 30 mm [1.2 in]	\varnothing 44 mm [1.7 in]	\varnothing 52 mm [2.0 in]	\varnothing 25 mm [1.0 in]
G 1 (from outside)	35 mm [1.4 in]	-	-	-
G 1 ½ (from outside)	35 mm [1.4 in]	45 mm [1.8 in]	-	25 mm [1.0 in]
G 2 (from outside)	40 mm [1.6 in]	50 mm [2.0 in]	50 mm [2.0 in]	25 mm [1.0 in]
Flange (from outside)	20 mm [0.8 in]	30 mm [1.2 in]	30 mm [1.2 in]	5 mm [0.2 in]
G ¼ B (from inside)	35 mm [1.4 in]	40 mm [1.6 in]	40 mm [1.6 in]	20 mm [0.8 in]
G ⅜ B (from inside)	35 mm [1.4 in]	40 mm [1.6 in]	40 mm [1.6 in]	20 mm [0.8 in]
G ½ B (from inside)	35 mm [1.4 in]	45 mm [1.8 in]	45 mm [1.8 in]	20 mm [0.8 in]

Dead band T in mm [in] (pipe end)

Dead band	Outer diameter float \varnothing D			
	\varnothing 30 mm [1.2 in]	\varnothing 44 mm [1.7 in]	\varnothing 52 mm [2.0 in]	\varnothing 25 mm [1.0 in]
T	35 mm [1.4 in]	45 mm [1.8 in]	45 mm [1.8 in]	45 mm [1.8 in]

Process connection

Installation from outside

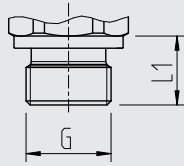

Installation from inside

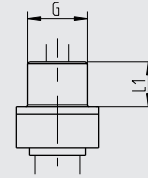

G	L ₁	Spanner width
G 1	16 mm [0.63 in]	41 mm [1.6 in]
G 1 ½	18 mm [0.71 in]	30 mm [1.2 in]
G 2	20 mm [0.79 in]	36 mm [1.4 in]

G	L ₁	Spanner width
G ¼ B	12 mm [0.47 in]	19 mm [0.7 in]
G ⅜ B	12 mm [0.47 in]	22 mm [0.9 in]
G ½ B	14 mm [0.55 in]	27 mm [1.1 in]

Flange

DN 50, form B per EN 1092-1 (DIN 2527), PN 16

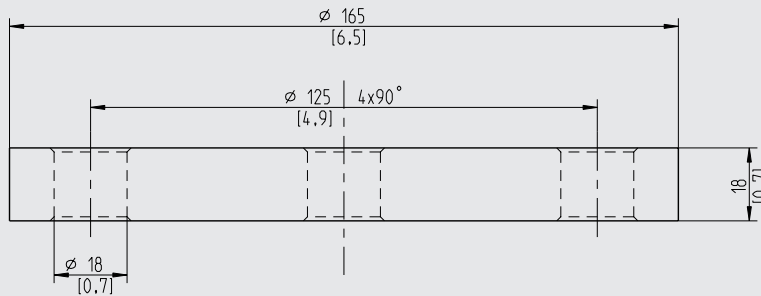

Accessories

Circular connector M12 x 1 with moulded cable

	Description	Temperature range	Cable diameter	Cable length	Order number
	Straight version, cut to length, 4-pin, PUR cable, UL listed, IP67	-20 ... +80 °C [-4 ... +176 °F]	4.5 mm [0.18 in]	2 m [6.6 ft]	14086880
				5 m [16.4 ft]	14086883
				10 m [32.8 ft]	14086884
	Angled version, cut to length, 4-pin, PUR cable, UL listed, IP67	-20 ... +80 °C [-4 ... +176 °F]	4.5 mm [0.18 in]	2 m [6.6 ft]	14086889
				5 m [16.4 ft]	14086891
				10 m [32.8 ft]	14086892

Approvals

Logo	Description	Country
	EU declaration of conformity <ul style="list-style-type: none">■ EMC directive■ EN 61326 emission (group 1, class B) and interference immunity (industrial application)■ RoHS directive	European Union

Manufacturer's information and certifications

Logo	Description
-	China RoHS directive

Approvals and certificates, see website

Ordering information

Model / Output signal / Electrical connection / Process connection / Guide tube length L / 100 % mark (optional) / Accuracy, resolution / Medium temperature / Float