

# Cable thermocouple Mineral-insulated cable (MI cable) Model TC40

WIKA data sheet TE 65.40



for further approvals  
see page 2

## Applications

- For direct installation into the process
- Machine building
- Motors
- Bearings
- Pipes and vessels

## Special features

- Sensor ranges from -40 ... +1,260 °C [-40 ... +2,300 °F]
- For insertion or screw-in with optional process connection
- Cable from fibreglass, PFA/PTFE, silicone and other cable sheath materials
- Versions with/without connector or connection housing (option)
- Explosion-protected versions (option)

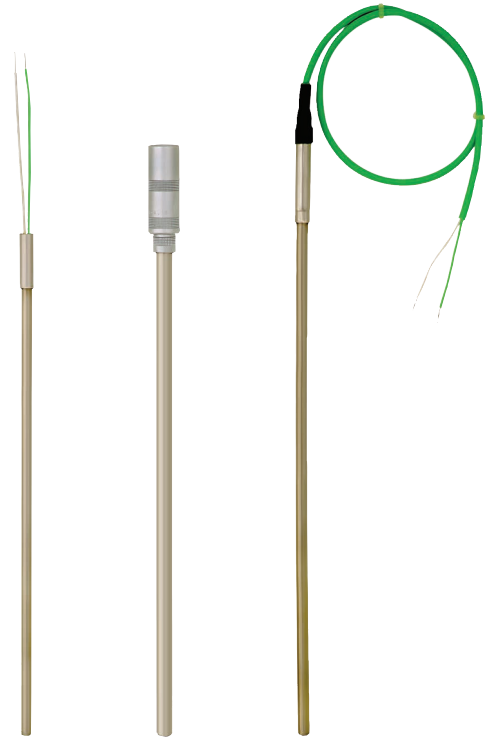

Cable thermocouple, model TC40

## Description

Cable thermocouples are particularly suited to those applications in which the metal probe tip is mounted directly into bored holes (e.g. in machine components) or directly into the process for any application with no chemically aggressive media or abrasion.

A large number of different explosion protection approvals are available for the TC40.

For mounting into a thermowell, a spring-loaded compression fitting should be provided, since only this can press the measuring tip into the bottom of the thermowell. Otherwise a potentially critical force could be exerted on the measuring tip.

In the standard version the cable probes are manufactured without process connections. Fastening elements such as threaded connections, compression fittings, etc. are possible as options.

## Explosion protection (option)





The permissible power,  $P_{max}$ , as well as the permissible ambient temperature, for the respective category can be seen on the EC-type examination certificate and the certificate for hazardous areas or the operating instructions.

The internal inductance ( $L_i = 1 \mu\text{H}/\text{m}$ ) and capacitance ( $C_i = 200 \text{ pF}/\text{m}$ ) for cable probes should be taken into account when connecting to an intrinsically safe voltage supply.

### Attention:

The transmitter, built into an optional connection housing, has its own certificate for hazardous areas. The permissible ambient temperature ranges of the built-in transmitters can be taken from the corresponding transmitter operating instructions and approvals.

## Approvals (explosion protection, further approvals)









| Logo   | Description  | Country                     |
|--|--|-----------------------------|
| <br><br> | <b>EU declaration of conformity</b><br><ul style="list-style-type: none"> <li>■ EMC directive <sup>1)</sup><br/>EN 61326 emission (group 1, class B) and immunity (industrial application)</li> <li>■ RoHS directive</li> <li>■ ATEX directive (option)<br/>Hazardous areas               <ul style="list-style-type: none"> <li>- Ex i Zone 0 gas II 1G Ex ia IIC T1 ... T6 Ga</li> <li>Zone 1 mounting to zone 0 gas II 1/2G Ex ia IIC T1 ... T6 Ga/Gb</li> <li>Zone 1 gas II 2G Ex ia IIC T1 ... T6 Gb</li> <li>Zone 20 dust II 1D Ex ia IIIC T125 ... T65 °C Da</li> <li>Zone 21 mounting to zone 20 dust II 1/2D Ex ia IIIC T125 ... T65 °C Da/Db</li> <li>Zone 21 dust II 2D Ex ia IIIC T125 ... T65 °C Db</li> <li>- Ex e <sup>2)</sup> Zone 1 gas <sup>3)</sup> II 2G Ex eb IIC T1 ... T6 Gb</li> <li>Zone 2 gas II 3G Ex ec IIC T1 ... T6 Gc X</li> <li>Zone 21 dust <sup>3)</sup> II 2D Ex tb IIIC TX °C Db</li> <li>Zone 22 dust II 3D Ex tc IIIC TX °C Dc X</li> <li>- Ex n <sup>2)</sup> Zone 2 gas II 3G Ex nA IIC T1 ... T6 Gc X</li> <li>Zone 22 dust II 3D Ex tc IIIC TX °C Dc X</li> </ul> </li> </ul> | European Union              |
|      | <b>IECEx (option) - in combination with ATEX</b><br>Hazardous areas <ul style="list-style-type: none"> <li>- Ex i Zone 0 gas Ex ia IIC T1 ... T6 Ga</li> <li>Zone 1 mounting to zone 0 gas Ex ia IIC T1 ... T6 Ga/Gb</li> <li>Zone 1 gas Ex ia IIC T1 ... T6 Gb</li> <li>Zone 20 dust Ex ia IIIC T125 ... T65 °C Da</li> <li>Zone 21 mounting to zone 20 dust Ex ia IIIC T125 ... T65 °C Da/Db</li> <li>Zone 21 dust Ex ia IIIC T125 ... T65 °C Db</li> <li>- Ex e <sup>4)</sup> Zone 1 gas <sup>3)</sup> Ex eb IIC T1 ... T6 Gb</li> <li>Zone 2 gas Ex ec IIC T1 ... T6 Gc</li> <li>Zone 21 dust <sup>3)</sup> Ex tb IIIC TX °C Db</li> <li>Zone 22 dust Ex tc IIIC TX °C Dc</li> <li>- Ex n <sup>4)</sup> Zone 2 gas Ex nA IIC T1 ... T6 Gc</li> <li>Zone 22 dust Ex tc IIIC TX °C Dc</li> </ul>   | International               |
|   | <b>EAC (option)</b><br>Hazardous areas <ul style="list-style-type: none"> <li>- Ex i Zone 0 gas 0 Ex ia IIC T6 ... T1 Ga X</li> <li>Zone 1 gas 1 Ex ia IIC T6 ... T1 Gb X</li> <li>Zone 20 dust Ex ia IIIC T80...T440 °C Da X</li> <li>Zone 21 dust Ex ia IIIC T80...T440 °C Db X</li> </ul>   | Eurasian Economic Community |

1) Only for built-in transmitter

2) Only with connection head, model BSZ, BSZ-H, 1/4000, 5/6000 or 7/8000 (see "Connection head")

3) Only for insulated thermocouples

4) Only with connection head, model 1/4000, 5/6000 or 7/8000 (see "Connection head")

| Logo  | Description   | Country     |
|---|---|-------------|
|    | <b>INMETRO (option)</b><br>Hazardous areas<br>- Ex i Zone 0 gas Ex ia IIC T3 ... T6 Ga<br>Zone 1 mounting to zone 0 gas Ex ia IIC T3 ... T6 Ga/Gb<br>Zone 1 gas Ex ia IIC T3 ... T6 Gb<br>Zone 20 dust Ex ia IIIC T125 ... T65 °C Da<br>Zone 21 mounting to zone 20 dust Ex ia IIIC T125 ... T65 °C Da/Db<br>Zone 21 dust Ex ia IIIC T125 ... T65 °C Db | Brazil      |
|    | <b>NEPSI (option)</b><br>Hazardous areas<br>- Ex i Zone 0 gas Ex ia IIC T1 ~ T6 Ga<br>Zone 1 mounting to zone 0 gas Ex ia IIC T1 ~ T6 Ga/Gb<br>Zone 1 gas Ex ia IIC T1 ~ T6 Gb<br>- Ex n <sup>4)</sup> Zone 2 gas Ex nA IIC T1 ~ T6 Gc  | China       |
|    | <b>KCs - KOSHA (option)</b><br>Hazardous areas<br>- Ex i Zone 0 gas Ex ia IIC T4 ... T6<br>Zone 1 gas Ex ib IIC T4 ... T6   | South Korea |
| -   | <b>PESO (option)</b><br>Hazardous areas<br>- Ex i Zone 0 gas Ex ia IIC T1 ... T6 Ga<br>Zone 1 mounting to zone 0 gas Ex ia IIC T1 ... T6 Ga/Gb<br>Zone 1 gas Ex ia IIC T1 ... T6 Gb   | India       |
|    | <b>GOST (option)</b><br>Metrology, measurement technology   | Russia      |
|    | <b>KazInMetr (option)</b><br>Metrology, measurement technology  | Kazakhstan  |
| -   | <b>MTSCHS (option)</b><br>Permission for commissioning  | Kazakhstan  |
|  | <b>BelGIM (option)</b><br>Metrology, measurement technology   | Belarus     |
|  | <b>UkrSEPRO (option)</b><br>Metrology, measurement technology   | Ukraine     |
|  | <b>Uzstandard (option)</b><br>Metrology, measurement technology   | Uzbekistan  |

## Manufacturer's information and certificates

| Logo  | Description  |
|---|--|
|  | <b>SIL 2</b><br>Functional safety (only in conjunction with model T32 temperature transmitter) |

4) Only with connection head, model 1/4000, 5/6000 or 7/8000 (see "Connection head")

Instruments marked with "ia" may also be used in areas only requiring instruments marked with "ib" or "ic".  
If an instrument with "ia" marking has been used in an area with requirements in accordance with "ib" or "ic", it can no longer be operated in areas with requirements in accordance with "ia" afterwards.

Approvals and certificates, see website

## Sensor

### Thermocouple per IEC 60584-1 or ASTM E230

Types K, J, E, N, T (single or dual thermocouple)

#### Measuring location

- Ungrounded (standard)

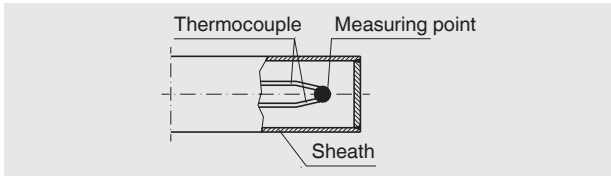

- Welded to the bottom (grounded)

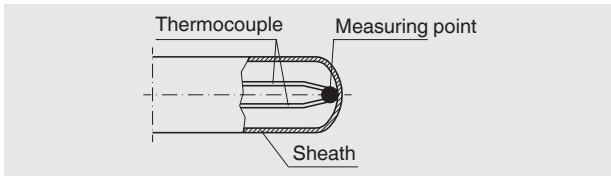

#### Sensor types

| Type     | Validity limits of the class accuracy |                     |                   |                     |                    |                  |
|----------|---------------------------------------|---------------------|-------------------|---------------------|--------------------|------------------|
|          | IEC 60584-1                           |                     |                   |                     | ASTM E230          |                  |
|          | Class 2                               |                     | Class 1           |                     | Standard / special |                  |
| <b>K</b> | -40 ... +1,200 °C                     | [-40 ... +2,192 °F] | -40 ... +1,000 °C | [-40 ... +1,832 °F] | 0 ... 1,260 °C     | [0 ... 2,300 °F] |
| <b>J</b> | -40 ... +750 °C                       | [-40 ... +1,382 °F] | -40 ... +750 °C   | [-40 ... +1,382 °F] | 0 ... 760 °C       | [0 ... 1,400 °F] |
| <b>E</b> | -40 ... +900 °C                       | [-40 ... +1,652 °F] | -40 ... +800 °C   | [-40 ... +1,472 °F] | 0 ... 870 °C       | [0 ... 1,598 °F] |
| <b>N</b> | -40 ... +1,200 °C                     | [-40 ... +2,192 °F] | -40 ... +1,000 °C | [-40 ... +1,832 °F] | 0 ... 1,260 °C     | [0 ... 2,300 °F] |
| <b>T</b> | -40 ... +350 °C                       | [-40 ... +662 °F]   | -40 ... +350 °C   | [-40 ... +662 °F]   | 0 ... 370 °C       | [0 ... 698 °F]   |

The table shows the temperature ranges listed in the respective standards, in which the tolerance values (class accuracies) are valid.

The actual operating temperature of the thermometer is limited both by the maximum permissible working temperature and the diameter of the thermocouple and the sheathed cable, as well as by the maximum permissible working temperature of the sheath material.

For detailed specifications for thermocouples, see IEC 60584-1 or ASTM E230 and Technical information IN 00.23 at [www.wika.com](http://www.wika.com).

#### Tolerance value

For the tolerance value of thermocouples, a cold junction temperature of 0 °C has been taken as the basis.

## Minimum and maximum operating temperature

### Process temperature

The process temperature is the temperature which prevails in the area between the probe tip and the process connection. This generally corresponds to the temperatures for which the thermocouple has been defined in accordance with IEC 60584-1 standard.

- Sheath material Ni alloy: Alloy 600
  - up to 1,200 °C (air)
  - standard material for applications which require specific corrosion-resistant properties under exposure to high temperatures, resistant to induced stress corrosion cracking and pitting corrosion in media containing chloride
  - resistant to corrosion caused by aqueous ammonia in all temperatures and concentrations
  - highly resistant to halogens, chlorine, hydrogen chloride
- Sheath material stainless steel
  - up to 850 °C (air)
  - good resistance against aggressive media and also against vapour and combustion gases in chemical media

Short insertion lengths and specific components can limit the operating temperature of the thermometer (e.g. PTFE ferrules on a compression fitting).

### Ambient temperature

The area of the transition from MI cable to connection cable (see page 13) and all subsequent components are located in the region of ambient temperature.

If the ambient temperature is higher than the permissible temperature at the cable, connector or transition, the metal parts of the probe must be long enough so that the transition is located outside of the hot zone. At any point on the connection cable, the maximum temperature that may be attained is that for which the connection cable is specified. The probe itself can – within the validity limits of its class accuracy – be loaded higher.

It is important to ensure that the lowest of the maximum permissible ambient temperatures for connection cables, materials used such as sealing compounds in the transition sleeve or a fitted connector or case is not exceeded.

- Maximum temperature at connection housing: 85 °C
- Maximum temperature at connector: 85 °C
- Maximum temperature of the sealing compound at the transition: 250 °C
- Maximum temperature of vibration-resistant versions: 200 °C
- In an optional approval minimum and maximum temperature specified

Other variants on request

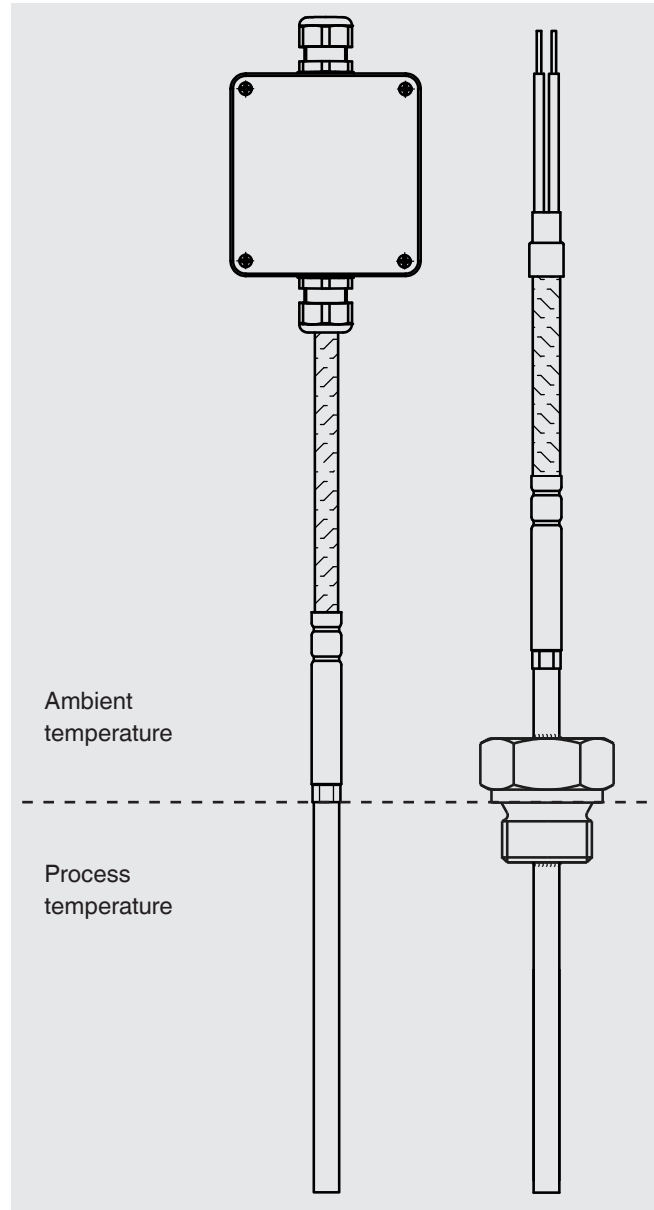

For information on the maximum permissible operating temperatures for the connection cable see page 14.

## General design of the TC40

In sheathed thermocouples the flexible part of the probe consists of a mineral-insulated cable (MI cable). It features a metal outer sheath, which contains the insulated internal leads, embedded within a high-density ceramic compound.

Due to their flexibility and the small possible diameters, sheathed thermocouples can also be used in locations that are not easily accessible, since, with the exception of the probe tip and the transition sleeve of the connection cable, the sheath can be bent to a radius of five times the diameter of the cable.

Please note:

The flexibility of the sheathed thermocouple must be considered, especially when the flow rates are relatively high.

For temperature measurement in a solid body, the diameter of the bore into which the probe should be inserted, should be no more than 1 mm larger than the probe diameter. Each air gap acts as an insulation layer.

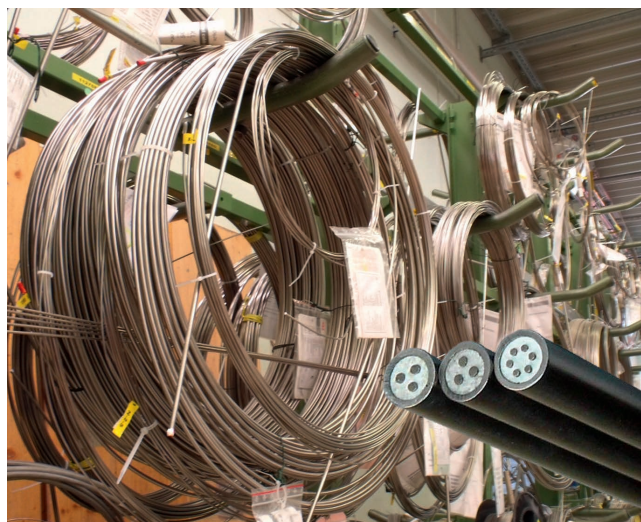

Mineral-insulated cable (MI cable)



Sensor in the probe tip

# Versions

## ■ With connection cable

Standard version

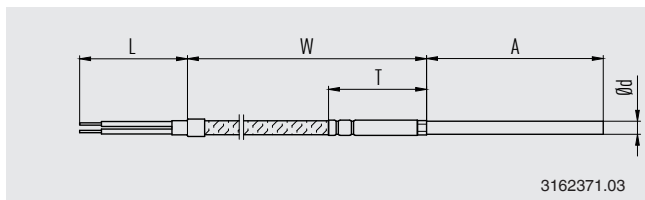

Single wires

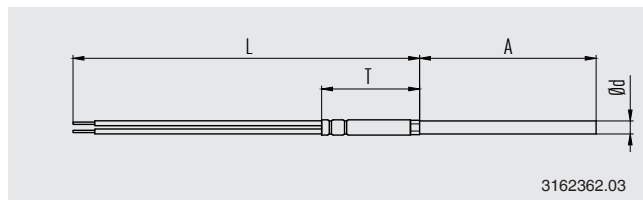

Connection cable with stainless steel braid

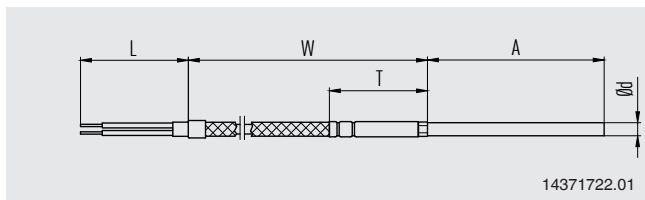

Connection cable with protective metal armouring

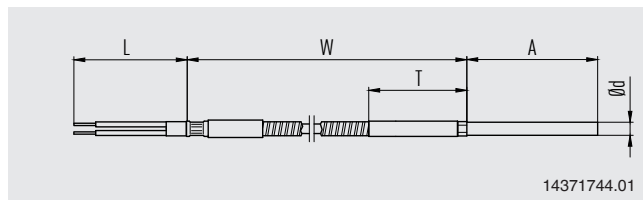

## ■ With connector

Fitted on the MI cable

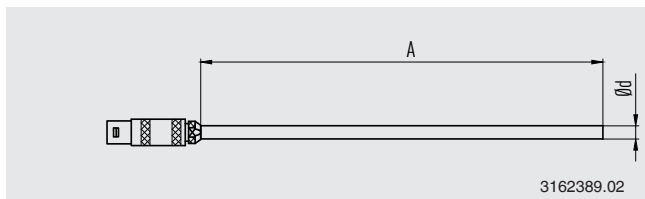

Fitted at the cable end

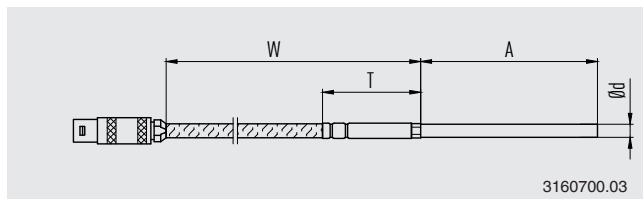

For all ignition protection types except Ex i, gas applies:  
Position of the connector is only permitted outside the hazardous area.

## ■ With connection housing, fitted at the cable end

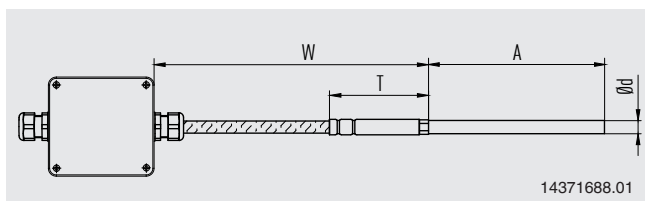

## Angled probes

TC40 cable thermocouples can be delivered in a pre-formed shape. In this case, the position of the bend is defined by a further dimension.

Using a fixed threaded connection is not recommended, as the angled probe would need to be screwed into the process with a wide sweeping movement.

Legend:

- X Distance of the bend to the end of the tube
- A Insertion length of the probe (section which is built into the process)
- Y Distance from the centre of the bend to the dimensioning plane of the threaded connection (only if a threaded connection is used)

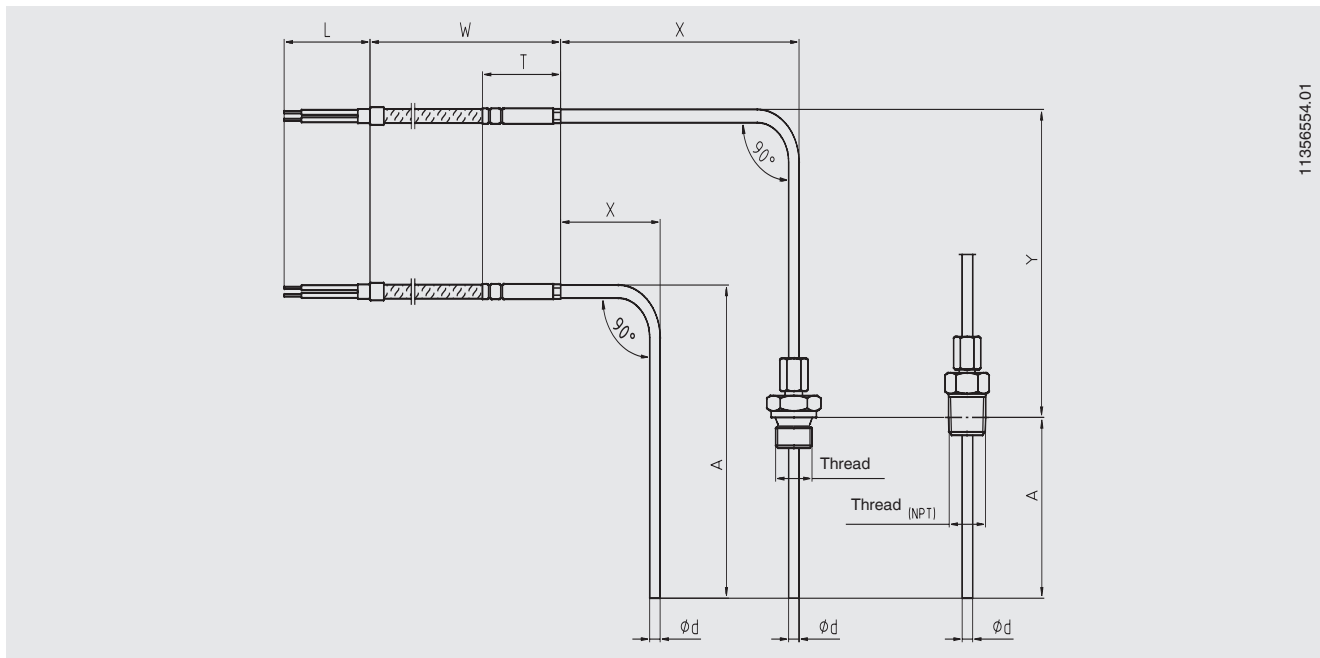

1135654.01

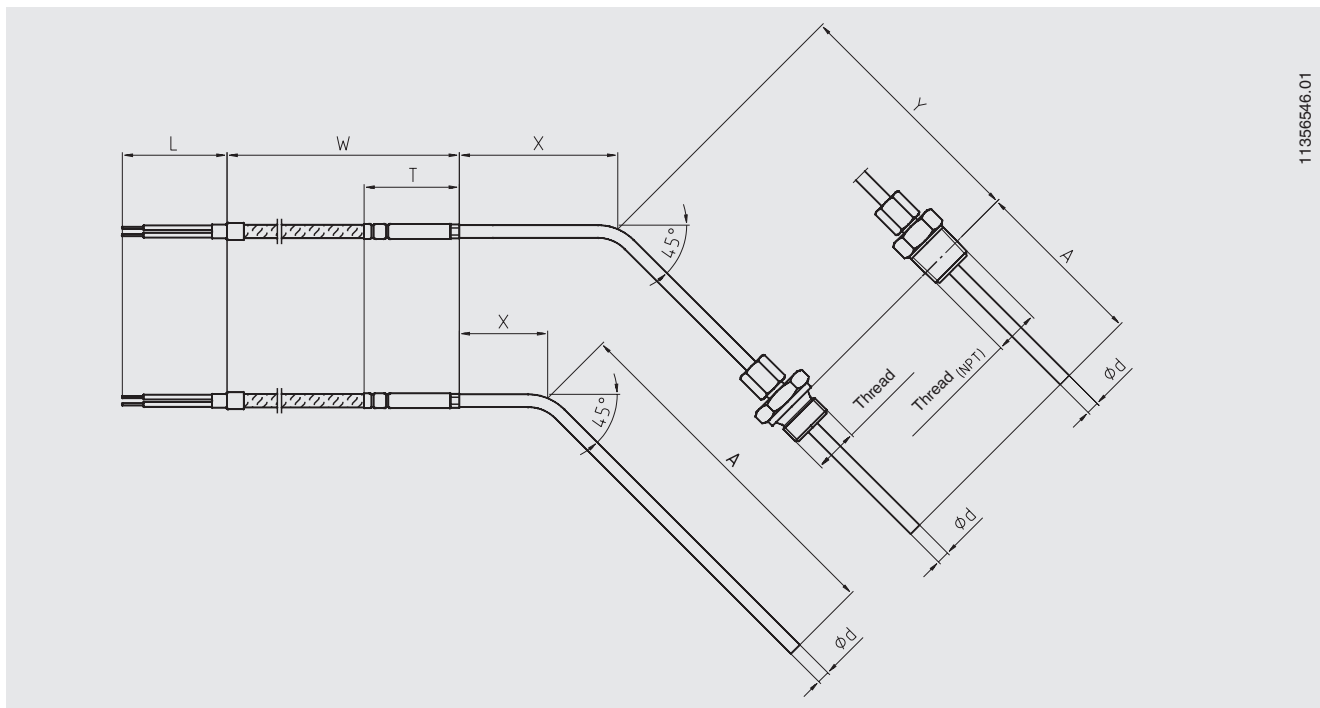

11356546.01



## Process connection

TC40 cable thermocouples can be fitted with optional process connections.

To minimise heat dissipation errors via the threaded connection, the insertion length, A, should be at least 25 mm long.

Please note:

- For parallel threads (e.g. G 1/2) the dimensioning always refers to the sealing collar of the threaded connection nearest the process
- For tapered threads (e.g. NPT) the measurement plane is located approx. in the centre of the thread

Legend:

- X Position of the threaded connection (independent of the type of connection)
- A Insertion length in the process

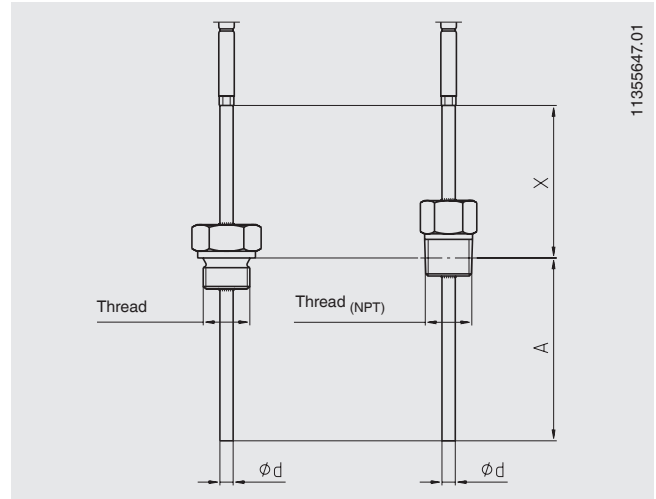

## International designs

### ■ Without process connection

Smooth probe for insertion

| Design                     | Illustration | Material process connection | Thread size | Diameter sheathed cable   | Material sheathed cable   |
|----------------------------|--------------|-----------------------------|-------------|---|---|
| Without process connection |              | -                           | -           | <ul style="list-style-type: none"> <li>■ 1.5 mm</li> <li>■ 2 mm</li> <li>■ 3 mm</li> <li>■ 4.5 mm</li> <li>■ 6 mm</li> <li>■ 8 mm</li> <li>■ 1/16 in/0.063 in [1.59 mm]</li> <li>■ 1/8 in/0.125 in [3.17 mm]</li> <li>■ 3/16 in/0.188 in [4.75 mm]</li> <li>■ 1/4 in/0.250 in [6.35 mm]</li> <li>■ 3/8 in/0.375 in [9.53 mm]</li> </ul> | <ul style="list-style-type: none"> <li>■ Alloy 600</li> <li>■ Stainless steel 1.4571</li> <li>■ Stainless steel 316L</li> </ul> |

### ■ Fixed threaded connection, thread

- Version to mount the probe into a threaded coupling with a female thread
- Probe must be rotated in order to screw it into the process
- Therefore, first fit the version mechanically and then connect it electrically

| Design                            | Illustration | Material process connection  | Thread size  | Diameter sheathed cable   | Material sheathed cable   |
|-----------------------------------|--------------|--|--|---|---|
| Fixed threaded connection, thread |              | <ul style="list-style-type: none"> <li>■ Stainless steel 1.4571</li> <li>■ Stainless steel 316L</li> </ul> | <ul style="list-style-type: none"> <li>■ G 1/8 B</li> <li>■ 1/8 NPT</li> <li>■ M8 x 1.0</li> </ul> | <ul style="list-style-type: none"> <li>■ 1.5 mm</li> <li>■ 2 mm</li> <li>■ 3 mm</li> <li>■ 1/16 in/0.063 in [1.59 mm]</li> <li>■ 1/8 in/0.125 in [3.17 mm]</li> </ul> | <ul style="list-style-type: none"> <li>■ Alloy 600</li> <li>■ Stainless steel 1.4571</li> <li>■ Stainless steel 316L</li> </ul> |

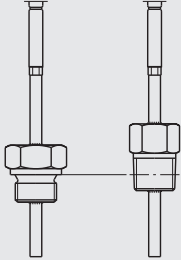
| Design                            | Illustration  | Material process connection  | Thread size   | Diameter sheathed cable   | Material sheathed cable   |
|-----------------------------------|---|--|---|---|---|
| Fixed threaded connection, thread |  | <ul style="list-style-type: none"> <li>■ Stainless steel 1.4571</li> <li>■ Stainless steel 316L</li> </ul> | <ul style="list-style-type: none"> <li>■ G 1/4 B</li> <li>■ G 3/8 B</li> <li>■ 1/4 NPT</li> <li>■ 3/8 NPT</li> <li>■ M10 x 1.0</li> </ul>   | <ul style="list-style-type: none"> <li>■ 3 mm</li> <li>■ 4.5 mm</li> <li>■ 6 mm</li> <li>■ 1/8 in/0.125 in [3.17 mm]</li> <li>■ 3/16 in/0.188 in [4.75 mm]</li> <li>■ 1/4 in/0.250 in [6.35 mm]</li> </ul>  | <ul style="list-style-type: none"> <li>■ Alloy 600</li> <li>■ Stainless steel 1.4571</li> <li>■ Stainless steel 316L</li> </ul> |
|                                   |   |  | <ul style="list-style-type: none"> <li>■ G 1/2 B</li> <li>■ G 3/4 B</li> <li>■ 1/2 NPT</li> <li>■ 3/4 NPT</li> <li>■ M12 x 1.5</li> <li>■ M14 x 1.5</li> <li>■ M16 x 1.5</li> <li>■ M18 x 1.5</li> <li>■ M20 x 1.5</li> </ul> | <ul style="list-style-type: none"> <li>■ 3 mm</li> <li>■ 4.5 mm</li> <li>■ 6 mm</li> <li>■ 8 mm</li> <li>■ 1/8 in/0.125 in [3.17 mm]</li> <li>■ 3/16 in/0.188 in [4.75 mm]</li> <li>■ 1/4 in/0.250 in [6.35 mm]</li> <li>■ 3/8 in/0.375 in [9.53 mm]</li> </ul> | <ul style="list-style-type: none"> <li>■ Alloy 600</li> <li>■ Stainless steel 1.4571</li> <li>■ Stainless steel 316L</li> </ul> |

■ **Compression fitting with stainless steel ferrule**

- Simple adjustment at the mounting point to the desired insertion length
- Compression fitting can be slid along the probe (only before the first tightening)
- After loosening, sliding along the sheathed cable is no longer possible
- Dimensions A and X describe the condition at time of supply
- Smallest possible length X of approx. 50 mm (due to the length of the compression fitting)
- Max. temperature at the process connection: 500 °C (unpressurised)
- Max. pressure loading: 20 bar (at max. 150 °C, Ø 6 mm)

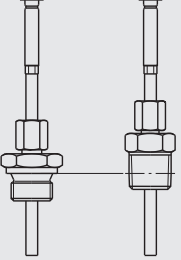
| Design   | Illustration   | Material process connection  | Thread size   | Diameter sheathed cable   | Material sheathed cable   |
|--|--|--|---|---|---|
| Compression fitting with stainless steel ferrule |  | <ul style="list-style-type: none"> <li>■ Stainless steel 1.4571</li> <li>■ Stainless steel 316L</li> </ul> | <ul style="list-style-type: none"> <li>■ G 1/8 B</li> <li>■ 1/8 NPT</li> <li>■ M8 x 1.0</li> </ul>  | <ul style="list-style-type: none"> <li>■ 3 mm</li> <li>■ 1/8 in/0.125 in [3.17 mm]</li> </ul>   | <ul style="list-style-type: none"> <li>■ Alloy 600</li> <li>■ Stainless steel 1.4571</li> <li>■ Stainless steel 316L</li> </ul> |
|  |  |  | <ul style="list-style-type: none"> <li>■ G 1/4 B</li> <li>■ G 3/8 B</li> <li>■ 1/4 NPT</li> <li>■ 3/8 NPT</li> <li>■ M10 x 1.0</li> </ul>   | <ul style="list-style-type: none"> <li>■ 3 mm</li> <li>■ 4.5 mm</li> <li>■ 6 mm</li> <li>■ 1/8 in/0.125 in [3.17 mm]</li> <li>■ 3/16 in/0.188 in [4.75 mm]</li> <li>■ 1/4 in/0.250 in [6.35 mm]</li> </ul>  | <ul style="list-style-type: none"> <li>■ Alloy 600</li> <li>■ Stainless steel 1.4571</li> <li>■ Stainless steel 316L</li> </ul> |
|  |  |  | <ul style="list-style-type: none"> <li>■ G 1/2 B</li> <li>■ G 3/4 B</li> <li>■ 1/2 NPT</li> <li>■ 3/4 NPT</li> <li>■ M12 x 1.5</li> <li>■ M14 x 1.5</li> <li>■ M16 x 1.5</li> <li>■ M18 x 1.5</li> <li>■ M20 x 1.5</li> </ul> | <ul style="list-style-type: none"> <li>■ 3 mm</li> <li>■ 4.5 mm</li> <li>■ 6 mm</li> <li>■ 8 mm</li> <li>■ 1/8 in/0.125 in [3.17 mm]</li> <li>■ 3/16 in/0.188 in [4.75 mm]</li> <li>■ 1/4 in/0.250 in [6.35 mm]</li> <li>■ 3/8 in/0.375 in [9.53 mm]</li> </ul> | <ul style="list-style-type: none"> <li>■ Alloy 600</li> <li>■ Stainless steel 1.4571</li> <li>■ Stainless steel 316L</li> </ul> |

■ **Compression fitting with PTFE ferrule**

- Basic construction as for the version with stainless steel ferrule
- Ferrules can be set several times
- After loosening, sliding along the sheath is still possible
- Max. temperature at process connection: 150 °C
- For use without pressure

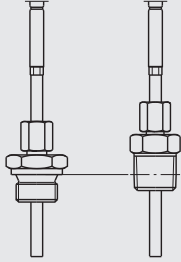

| Design                                       | Illustration  | Material process connection  | Thread size   | Diameter sheathed cable   | Material sheathed cable   |
|--|---|--|---|---|---|
| <b>Compression fitting with PTFE ferrule</b> |  | <ul style="list-style-type: none"> <li>■ Stainless steel 1.4571</li> <li>■ Stainless steel 316L</li> </ul> | <ul style="list-style-type: none"> <li>■ G 1/8 B</li> <li>■ 1/8 NPT</li> <li>■ M8 x 1.0</li> </ul>  | <ul style="list-style-type: none"> <li>■ 1.5 mm</li> <li>■ 2 mm</li> <li>■ 3 mm</li> <li>■ 1/16 in/0.063 in [1.59 mm]</li> <li>■ 1/8 in/0.125 in [3.17 mm]</li> </ul>   | <ul style="list-style-type: none"> <li>■ Alloy 600</li> <li>■ Stainless steel 1.4571</li> <li>■ Stainless steel 316L</li> </ul> |
|  |   |  | <ul style="list-style-type: none"> <li>■ G 1/4 B</li> <li>■ G 3/8 B</li> <li>■ 1/4 NPT</li> <li>■ 3/8 NPT</li> <li>■ M10 x 1.0</li> </ul>   | <ul style="list-style-type: none"> <li>■ 3 mm</li> <li>■ 4.5 mm</li> <li>■ 6 mm</li> <li>■ 1/8 in/0.125 in [3.17 mm]</li> <li>■ 3/16 in/0.188 in [4.75 mm]</li> <li>■ 1/4 in/0.250 in [6.35 mm]</li> </ul>  | <ul style="list-style-type: none"> <li>■ Alloy 600</li> <li>■ Stainless steel 1.4571</li> <li>■ Stainless steel 316L</li> </ul> |
|  |   |  | <ul style="list-style-type: none"> <li>■ G 1/2 B</li> <li>■ G 3/4 B</li> <li>■ 1/2 NPT</li> <li>■ 3/4 NPT</li> <li>■ M12 x 1.5</li> <li>■ M14 x 1.5</li> <li>■ M16 x 1.5</li> <li>■ M18 x 1.5</li> <li>■ M20 x 1.5</li> </ul> | <ul style="list-style-type: none"> <li>■ 3 mm</li> <li>■ 4.5 mm</li> <li>■ 6 mm</li> <li>■ 8 mm</li> <li>■ 1/8 in/0.125 in [3.17 mm]</li> <li>■ 3/16 in/0.188 in [4.75 mm]</li> <li>■ 1/4 in/0.250 in [6.35 mm]</li> <li>■ 3/8 in/0.375 in [9.53 mm]</li> </ul> | <ul style="list-style-type: none"> <li>■ Alloy 600</li> <li>■ Stainless steel 1.4571</li> <li>■ Stainless steel 316L</li> </ul> |

■ **Spring-loaded compression fitting with stainless steel ferrule**

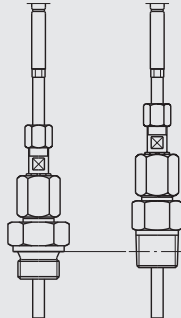
- Easy adjustment to the desired insertion length at the mounting point, while at the same time maintaining the spring pre-tension
- Compression fitting can be slid along the probe (only before the first tightening)
- After loosening, sliding along the sheathed cable is no longer possible
- Dimensions A and X describe the condition at time of supply
- Smallest possible length X of approx. 100 mm (due to the length of the compression fitting)
- Max. temperature at process connection: 150 °C
- For use without pressure
- Hydraulic oil-tight versions on request

| Design  | Illustration  | Material process connection  | Thread size  | Diameter sheathed cable | Material sheathed cable   |
|---|---|--|--|-------------------------|---|
| <b>Spring-loaded compression fitting with stainless steel ferrule</b> |  | <ul style="list-style-type: none"> <li>■ Stainless steel 1.4571</li> <li>■ Stainless steel 316L</li> </ul> | <ul style="list-style-type: none"> <li>■ G 1/4 B</li> <li>■ G 3/8 B</li> <li>■ G 1/2 B</li> <li>■ G 3/4 B</li> <li>■ 1/4 NPT</li> <li>■ 3/8 NPT</li> <li>■ 1/2 NPT</li> <li>■ 3/4 NPT</li> <li>■ M10 x 1.0</li> <li>■ M12 x 1.5</li> <li>■ M14 x 1.5</li> <li>■ M16 x 1.5</li> <li>■ M18 x 1.5</li> <li>■ M20 x 1.5</li> </ul> | 6 mm                    | <ul style="list-style-type: none"> <li>■ Alloy 600</li> <li>■ Stainless steel 1.4571</li> <li>■ Stainless steel 316L</li> </ul> |

## US design

| Design   | Illustration  | Material process connection | Thread size  | Diameter sheathed cable  | Material sheathed cable   |
|--|---|-----------------------------|--|--|---|
| <b>Spring-loaded threaded connection (standard)</b>  |  | Stainless steel 316L        | <ul style="list-style-type: none"> <li>■ 1/4 NPT</li> <li>■ 3/8 NPT</li> <li>■ 1/2 NPT</li> <li>■ 3/4 NPT</li> </ul> | <ul style="list-style-type: none"> <li>■ 6 mm</li> <li>■ 1/4 in/0.250 in [6.35 mm]</li> <li>■ 1/8 in/0.125 in [3.17 mm]</li> </ul> | <ul style="list-style-type: none"> <li>■ Alloy 600</li> <li>■ Stainless steel 316L</li> </ul> |
| <b>Spring-loaded threaded connection with O-ring sealing</b><br>(rated to 100 psi at 86 °C, hydrostatic testing in H <sub>2</sub> O) |  | Stainless steel 316L        | <ul style="list-style-type: none"> <li>■ 1/4 NPT</li> <li>■ 3/8 NPT</li> <li>■ 1/2 NPT</li> <li>■ 3/4 NPT</li> </ul> | 1/4 in/0.250 in [6.35 mm]  | <ul style="list-style-type: none"> <li>■ Alloy 600</li> <li>■ Stainless steel 316L</li> </ul> |
| <b>Fixed fitting/double threaded hex bushing (welded)</b>  |  | Stainless steel 316L        | <ul style="list-style-type: none"> <li>■ 1/2 NPT</li> <li>■ 3/4 NPT</li> </ul>                                       | 1/4 in/0.250 in [6.35 mm]  | <ul style="list-style-type: none"> <li>■ Alloy 600</li> <li>■ Stainless steel 316L</li> </ul> |

## Transition

### Standard version

The junction between the metal part of the probe and the connection lead or stranded wire should not be immersed within the process and must not be bent. Compression fittings should not be attached to the transition sleeve.

The dimensions of the transition sleeve are dependent upon the probe diameter, on the construction of the connection cable and its number of inner conductors - depending on the connection method. Also, operation with ambient temperatures  $< -40\text{ °C}$  has an influence on the dimensions of the transition sleeve.

### Transition sleeve with the same diameter as the probe

Optionally, a transition sleeve can also be selected that has the same diameter as the metal probe. This makes it possible to slide on cable glands or compression fittings from both ends of the probe. The transition is hardly visible.

The operating limits of the transition sleeve do not change, however, i.e. it must still remain outside the process and should not be loaded with a compression fitting.

Standard diameter transition sleeve and probe

- 6 mm
- 8 mm
- 1/4 in

## Bend protection

A bend protection (spring or shrink hose) is used to protect the transition point from rigid probe to flexible connection lead. This should always be used when a relative movement between the connection lead and the thermometer mounting is expected.

For designs to Ex n or Ex e, the use of bend protection is mandatory.



Bend protection spring



Shrink hose

Both versions should be considered to be technically equivalent with respect to their function as bend protection.

## Connection cable, jacket

| Cable jacket  | Application range <sup>1)</sup> |
|---|---------------------------------|
| PTFE  | -60 ... +250 °C                 |
| PTFE, shielded (see standard versions below)          | -60 ... +250 °C                 |
| Single wires, PTFE                                    | -60 ... +250 °C                 |
| Stainless steel braid over PTFE                       | -60 ... +250 °C                 |
| Silicone  | -60 ... +200 °C                 |
| Silicone, shielded (see standard versions below)      | -60 ... +200 °C                 |
| PVC   | -20 ... +100 °C                 |
| Fibreglass  | -50 ... +400 °C                 |
| Stainless steel braid over fibreglass                 | -50 ... +400 °C                 |
| Protective metal armouring over PTFE                  | -60 ... +250 °C                 |
| Protective metal armouring over PFA                   | -50 ... +250 °C                 |
| Protective metal armouring with PTFE sheath over PTFE | -60 ... +250 °C                 |
| Protective metal armouring with PVC sheath over PVC   | -20 ... +100 °C                 |
| Protective metal armouring with PE sheath over PFA    | -50 ... +250 °C                 |

### Colour code of cable

| Sensor type | Standard    | Thermocouple cable, compensating cable |          |          |
|-------------|-------------|--|----------|----------|
|             |             | Outer sheath                           | Positive | Negative |
| K           | IEC 60584-3 | Green                                  | Green    | White    |
| J           | IEC 60584-3 | Black                                  | Black    | White    |
| E           | IEC 60584-3 | Violet                                 | Violet   | White    |
| T           | IEC 60584-3 | Brown                                  | Brown    | White    |
| N           | IEC 60584-3 | Pink                                   | Pink     | White    |

| Sensor type | Standard  | Thermocouple cable |          |          | Compensating cable |          |          |
|-------------|-----------|--------------------|----------|----------|--------------------|----------|----------|
|             |           | Outer sheath       | Positive | Negative | Outer sheath       | Positive | Negative |
| K           | ASTM E230 | Brown              | Yellow   | Red      | Yellow             | Yellow   | Red      |
| J           | ASTM E230 | Brown              | White    | Red      | Black              | White    | Red      |
| E           | ASTM E230 | Brown              | Violet   | Red      | Violet             | Violet   | Red      |
| T           | ASTM E230 | Brown              | Blue     | Red      | Blue               | Blue     | Red      |
| N           | ASTM E230 | Brown              | Orange   | Red      | Orange             | Orange   | Red      |

For further information on colour coding, see Technical information IN 00.23 at [www.wika.com](http://www.wika.com).

### Standard cable lengths

#### Metric lengths

- 1,000 mm
- 2,000 mm
- 3,000 mm
- 5,000 mm

#### Imperial lengths

- 24 in
- 36 in
- 72 in
- 144 in

Other cable lengths are possible

### Standard versions of the shield electrical connection

- Shield not connected at the sensor, stripped lead at the end of the cable
  - Shield connected at the sensor, stripped lead at the end of the cable
  
  - Shield not connected at the sensor, connected at the housing
  - Shield connected at the sensor, connected at the case
  
  - Shield not connected at the sensor, connected at the connector
  - Shield connected at the sensor, connected at the connector
  - Shield connected at the sensor, not connected at the connector
- Other versions on request

1) Minimum/Maximum temperatures valid for stationary cable. The actual operating temperature (process temperature) of the thermometer can deviate.

### Design of the lead ends

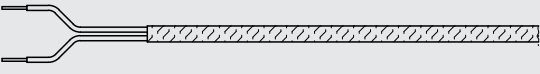
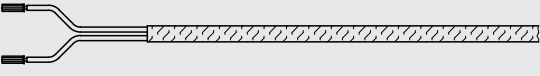
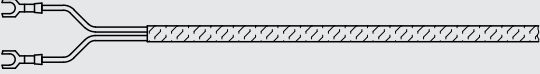

| Version                    | Illustration  |
|----------------------------|---|
| Flying leads <sup>1)</sup> |   |
| End splices                |   |
| Spade lugs (fork design)   |  |

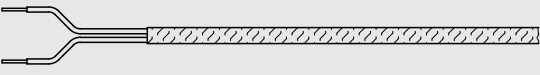
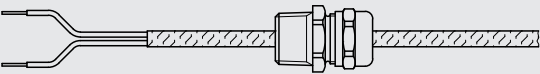
### Cord grip

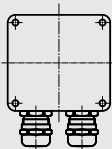
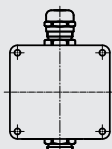

| Thread size | Material | Illustration   |
|-------------|----------|--|
| Without     | -        |  |
| M16 x 1.5   | Plastic  |  |
| M20 x 1.5   | Plastic  |  |
| 1/2 NPT     | Plastic  |  |
| 1/2 NPT     | Metal    |  |
| 3/4 NPT     | Metal    |  |

1) Not permissible with Ex e or Ex n

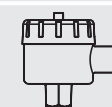
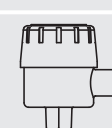
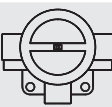
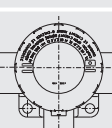
## Connection housing (option)

| Illustration  | Model      | Material        | Cable entry thread size   | Cover   | Surface                     | Other   |
|---|------------|-----------------|---|---|-----------------------------|---|
|    | Field case | Plastic (ABS)   | <ul style="list-style-type: none"> <li>■ M12 x 1.5</li> <li>■ 1/2 NPT</li> <li>■ M16 x 1.5</li> </ul>           | Flat cover with 4 plug screws                                 | Grey                        | <ul style="list-style-type: none"> <li>■ 82 x 80 x 55 mm (L x W x H)</li> <li>■ Inputs on one side</li> </ul>         |
|   | Field case | Aluminium       | <ul style="list-style-type: none"> <li>■ M12 x 1.5</li> <li>■ 1/2 NPT</li> <li>■ M16 x 1.5</li> </ul>           | Flat cover with 4 plug screws                                 | Natural finish              | <ul style="list-style-type: none"> <li>■ 80 x 75 x 57 mm (L x W x H)</li> <li>■ Inputs on one side</li> </ul>         |
|    | Field case | Plastic (ABS)   | <ul style="list-style-type: none"> <li>■ M12 x 1.5</li> <li>■ 1/2 NPT</li> <li>■ M16 x 1.5</li> </ul>           | Flat cover with 4 plug screws                                 | Grey                        | <ul style="list-style-type: none"> <li>■ 82 x 80 x 55 mm (L x W x H)</li> <li>■ Inputs opposite each other</li> </ul> |
|   | Field case | Aluminium       | <ul style="list-style-type: none"> <li>■ M12 x 1.5</li> <li>■ 1/2 NPT</li> <li>■ M16 x 1.5</li> </ul>           | Flat cover with 4 plug screws                                 | Natural finish              | <ul style="list-style-type: none"> <li>■ 80 x 75 x 57 mm (L x W x H)</li> <li>■ Inputs opposite each other</li> </ul> |
|    | 1/4000     | Aluminium       | <ul style="list-style-type: none"> <li>■ M20 x 1.5</li> <li>■ 1/2 NPT</li> <li>■ 3/4 NPT</li> </ul>             | Screw-on lid  | Blue, painted <sup>1)</sup> | -   |
|   | 1/4000     | Stainless steel | <ul style="list-style-type: none"> <li>■ M20 x 1.5</li> <li>■ 1/2 NPT</li> <li>■ 3/4 NPT</li> </ul>             | Screw-on lid  | Natural finish              | -   |
|    | 7/8000     | Aluminium       | <ul style="list-style-type: none"> <li>■ M20 x 1.5</li> <li>■ 1/2 NPT</li> <li>■ 3/4 NPT</li> </ul>             | Screw-on lid  | Blue, painted <sup>1)</sup> | -   |
|   | 7/8000     | Stainless steel | <ul style="list-style-type: none"> <li>■ M20 x 1.5</li> <li>■ 1/2 NPT</li> <li>■ 3/4 NPT</li> </ul>             | Screw-on lid  | Natural finish              | -   |
|  | 7/8000     | Aluminium       | <ul style="list-style-type: none"> <li>■ M20 x 1.5</li> <li>■ 1/2 NPT</li> <li>■ 3/4 NPT</li> </ul>             | Screw-on lid, with digital temperature display, model DIH50-B | Blue, painted <sup>1)</sup> | -   |
|   | 7/8000     | Stainless steel | <ul style="list-style-type: none"> <li>■ M20 x 1.5</li> <li>■ 1/2 NPT</li> <li>■ 3/4 NPT</li> </ul>             | Screw-on lid, with digital temperature display, model DIH50-B | Natural finish              | -   |
|  | 5/6000     | Aluminium       | <ul style="list-style-type: none"> <li>■ 2 x M20 x 1.5</li> <li>■ 2 x 1/2 NPT</li> <li>■ 2 x 3/4 NPT</li> </ul> | Screw-on lid  | Blue, painted <sup>1)</sup> | -   |
|   | 5/6000     | Stainless steel | <ul style="list-style-type: none"> <li>■ 2 x M20 x 1.5</li> <li>■ 2 x 1/2 NPT</li> <li>■ 2 x 3/4 NPT</li> </ul> | Screw-on lid  | Natural finish              | -   |
|  | 5/6000     | Aluminium       | <ul style="list-style-type: none"> <li>■ 2 x M20 x 1.5</li> <li>■ 2 x 1/2 NPT</li> <li>■ 2 x 3/4 NPT</li> </ul> | Screw-on lid, with digital temperature display, model DIH50-B | Blue, painted <sup>1)</sup> | -   |
|   | 5/6000     | Stainless steel | <ul style="list-style-type: none"> <li>■ 2 x M20 x 1.5</li> <li>■ 2 x 1/2 NPT</li> <li>■ 2 x 3/4 NPT</li> </ul> | Screw-on lid, with digital temperature display, model DIH50-B | Natural finish              | -   |

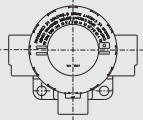

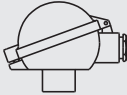
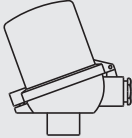
| Illustration  | Model                                 | Material        | Cable entry thread size   | Cover                                   | Surface                     | Other |
|---|---------------------------------------|-----------------|---|---|-----------------------------|-------|
|  | Field transmitter TIF50 <sup>2)</sup> | Aluminium       | <ul style="list-style-type: none"> <li>■ 2 x M20 x 1.5</li> <li>■ 2 x 1/2 NPT</li> <li>■ 2 x 3/4 NPT</li> </ul> | -                                       | -                           | -     |
|   | Field transmitter TIF50 <sup>2)</sup> | Stainless steel | <ul style="list-style-type: none"> <li>■ 2 x M20 x 1.5</li> <li>■ 2 x 1/2 NPT</li> <li>■ 2 x 3/4 NPT</li> </ul> | -                                       | -                           | -     |
|   | Field transmitter TIF52 <sup>2)</sup> | Aluminium       | <ul style="list-style-type: none"> <li>■ 2 x M20 x 1.5</li> <li>■ 2 x 1/2 NPT</li> <li>■ 2 x 3/4 NPT</li> </ul> | -                                       | -                           | -     |
|   | Field transmitter TIF52 <sup>2)</sup> | Stainless steel | <ul style="list-style-type: none"> <li>■ 2 x M20 x 1.5</li> <li>■ 2 x 1/2 NPT</li> <li>■ 2 x 3/4 NPT</li> </ul> | -                                       | -                           | -     |
|  | KN4-A <sup>2)</sup>                   | Aluminium       | <ul style="list-style-type: none"> <li>■ M20 x 1.5</li> <li>■ 1/2 NPT</li> <li>■ 3/4 NPT</li> </ul>             | Screw-on lid                            | Blue, painted <sup>1)</sup> | -     |
|   | KN4-P <sup>2)</sup>                   | Polypropylene   | <ul style="list-style-type: none"> <li>■ M20 x 1.5</li> <li>■ 1/2 NPT</li> <li>■ 3/4 NPT</li> </ul>             | Screw-on lid                            | White                       | -     |
|  | BSZ <sup>3)</sup>                     | Aluminium       | <ul style="list-style-type: none"> <li>■ M20 x 1.5</li> <li>■ 1/2 NPT</li> </ul>                                | Spherical, hinged cover with plug screw | Blue, painted <sup>1)</sup> | -     |
|  | BSZ-H <sup>3)</sup>                   | Aluminium       | <ul style="list-style-type: none"> <li>■ M20 x 1.5</li> <li>■ 1/2 NPT</li> </ul>                                | High hinged cover with plug screw       | Blue, painted <sup>1)</sup> | -     |

1) RAL 5022

2) Not permissible with Ex e or Ex n

3) Not permissible with IECEx (Ex e or Ex n) and NEPSI (Ex n)

| Model                        | Explosion protection |                               |                                   |                          |                            |                          |                          |                            |
|------------------------------|----------------------|-------------------------------|-----------------------------------|--------------------------|----------------------------|--------------------------|--------------------------|----------------------------|
|                              | Without              | Ex i (gas)<br>Zone 0,<br>1, 2 | Ex i (dust)<br>Zone 20, 21,<br>22 | Ex eb<br>(gas)<br>Zone 1 | Ex tb<br>(dust)<br>Zone 21 | Ex ec<br>(gas)<br>Zone 2 | Ex nA<br>(gas)<br>Zone 2 | Ex tc<br>(dust)<br>Zone 22 |
| Field case, plastic (ABS)    | x                    | -                             | -                                 | -                        | -                          | -                        | -                        | -                          |
| Field case, aluminium        | x                    | x                             | x                                 | x                        | x                          | x                        | x                        | x                          |
| 1/4000                       | x                    | x                             | x                                 | x                        | x                          | x                        | x                        | x                          |
| 7/8000                       | x                    | x                             | x                                 | x                        | x                          | x                        | x                        | x                          |
| 7/8000 / DIH50 <sup>2)</sup> | x                    | x                             | x                                 | -                        | -                          | -                        | -                        | -                          |
| 5/6000                       | x                    | x                             | x                                 | x                        | x                          | x                        | x                        | x                          |
| TIF50                        | x                    | x                             | x                                 | -                        | -                          | -                        | -                        | -                          |
| TIF52                        | x                    | x                             | x                                 | -                        | -                          | -                        | -                        | -                          |
| KN4-A                        | x                    | x                             | -                                 | -                        | -                          | -                        | -                        | -                          |
| KN4-P <sup>1)</sup>          | x                    | -                             | -                                 | -                        | -                          | -                        | -                        | -                          |
| BSZ                          | x                    | x                             | x                                 | x <sup>3)</sup>          | x <sup>3)</sup>            | x <sup>3)</sup>          | x <sup>3)</sup>          | x <sup>3)</sup>            |
| BSZ-H                        | x                    | x                             | x                                 | x <sup>3)</sup>          | x <sup>3)</sup>            | x <sup>3)</sup>          | x <sup>3)</sup>          | x <sup>3)</sup>            |



1) On request

2) LC display DIH50

3) Only ATEX, no IECEx, no NEPSI

### Position of the probe input

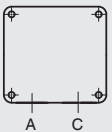
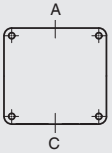
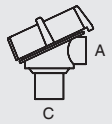
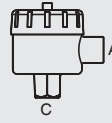
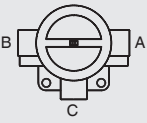
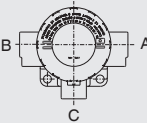
The standard probe input is located at position C.  
 Another position for the probe input is possible as an option.

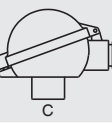
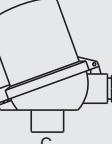
| Illustration  | Connection housing  |
|---|---|
|    | Field case with inputs on either side                                   |
|    | Field case with inputs on opposite sides                                |
|    | Connection housing 1/4000   |
|    | Connection housing 7/8000<br>Connection housing 7/8000 with DIH50       |
|    | Connection housing 5/6000   |
|  | Connection housing 5/6000 with DIH50-B<br>Field transmitter TIF50/TIF52 |
|  | Connection head KN4-A   |
|  | Connection head BSZ   |
|  | Connection head BSZ-H   |

## Cable entry

| Cable entry  | Colour              | Ingress protection (max.) IEC/EN 60529 | Cable entry thread size        | Min./max. ambient temperature               |
|--|---------------------|--|--------------------------------|---|
|  <b>Standard cable entry</b> <sup>1)</sup>                            | Natural finish      | IP65                                   | ■ M20 x 1.5<br>■ ½ NPT         | -40 ... +80 °C                              |
|  <b>Plastic cable gland (cable Ø 6 ... 10 mm)</b> <sup>1)</sup>       | Black or grey       | IP66 <sup>2)</sup>                     | ■ M20 x 1.5<br>■ ½ NPT         | -40 ... +80 °C                              |
|  <b>Plastic cable gland (cable Ø 6 ... 10 mm), Ex e</b> <sup>1)</sup> | Light blue or black | IP66 <sup>2)</sup>                     | ■ M20 x 1.5<br>■ ½ NPT         | -20 ... +80 °C<br>Option:<br>-40 ... +70 °C |
|  <b>Nickel-plated brass cable gland (cable Ø 6 ... 12 mm)</b>         | Natural finish      | IP66 <sup>2)</sup>                     | ■ M20 x 1.5<br>■ ½ NPT         | -60 <sup>3)</sup> / -40 ... +80 °C          |
|  | Natural finish      | IP66 <sup>2)</sup>                     | ■ M20 x 1.5<br>■ ½ NPT         | -60 <sup>3)</sup> / -40 ... +80 °C          |
|  <b>Stainless steel cable gland (cable Ø 7 ... 12 mm)</b>             | Natural finish      | IP66 <sup>2)</sup>                     | ■ M20 x 1.5<br>■ ½ NPT         | -60 <sup>3)</sup> / -40 ... +80 °C          |
|  | Natural finish      | IP66 <sup>2)</sup>                     | ■ M20 x 1.5<br>■ ½ NPT         | -60 <sup>3)</sup> / -40 ... +80 °C          |
|  <b>Plain threaded</b>  | -                   | IP00                                   | ■ M20 x 1.5<br>■ ½ NPT         | -   |
|  <b>2 x plain threaded</b> <sup>4)</sup>                            | -                   | IP00                                   | ■ 2 x M20 x 1.5<br>■ 2 x ½ NPT | -   |
|  <b>Junction box M12 x 1 (4-pin)</b> <sup>5)</sup>                  | -                   | IP65                                   | M20 x 1.5                      | -40 ... +80 °C                              |
|  <b>Sealing plugs for shipping</b>                                  | Transparent         | -                                      | ■ M20 x 1.5<br>■ ½ NPT         | -40 ... +80 °C                              |

The figures show examples of connection heads.

1) Not available for BVS connection head

2) Only for BSZ-H connection head

3) Not available for ½ NPT thread size cable entry

4) Special version on request (only available with selected approvals), other temperatures on request

5) Ignition protection types, describing temporary or permanent immersion, on request

| Cable entry  | Explosion protection                 |                                  |                                      |                          |                            |                                     |                          |                            |
|--|--------------------------------------|----------------------------------|--------------------------------------|--------------------------|----------------------------|-------------------------------------|--------------------------|----------------------------|
|  | Without                              | Ex i<br>(gas)<br>Zone 0,<br>1, 2 | Ex i<br>(dust)<br>Zone 20,<br>21, 22 | Ex eb<br>(gas)<br>Zone 1 | Ex tb<br>(dust)<br>Zone 21 | Ex ec<br>(gas)<br>Zone 2,<br>21, 22 | Ex nA<br>(gas)<br>Zone 2 | Ex tc<br>(dust)<br>Zone 22 |
| Standard cable entry <sup>1)</sup>                   | x                                    | x                                | -                                    | -                        | -                          | -                                   | -                        | -                          |
| Plastic cable gland <sup>1)</sup>                    | x                                    | x                                | -                                    | -                        | -                          | -                                   | -                        | -                          |
| Plastic cable gland (light blue), Ex e <sup>1)</sup> | x                                    | x                                | x                                    | -                        | -                          | -                                   | -                        | -                          |
| Plastic cable gland (black), Ex e <sup>1)</sup>      | x                                    | x                                | x                                    | x                        | x                          | x                                   | x                        | x                          |
| Brass cable gland, nickel-plated                     | x                                    | x                                | x                                    | -                        | -                          | -                                   | -                        | -                          |
| Brass cable gland, nickel-plated, Ex e               | x                                    | x                                | x                                    | x                        | x                          | x                                   | x                        | x                          |
| Stainless steel cable gland                          | x                                    | x                                | x                                    | -                        | -                          | -                                   | -                        | -                          |
| Stainless steel cable gland, Ex e                    | x                                    | x                                | x                                    | x                        | x                          | x                                   | x                        | x                          |
| Plain threaded                                       | x                                    | x                                | x <sup>5)</sup>                      | x <sup>5)</sup>          | x <sup>5)</sup>            | x <sup>5)</sup>                     | x <sup>5)</sup>          | x <sup>5)</sup>            |
| 2 x plain threaded <sup>2)</sup>                     | x                                    | x                                | x <sup>5)</sup>                      | x <sup>5)</sup>          | x <sup>5)</sup>            | x <sup>5)</sup>                     | x <sup>5)</sup>          | x <sup>5)</sup>            |
| Junction box M12 x 1 (4-pin) <sup>3)</sup>           | x                                    | x <sup>4)</sup>                  | x <sup>4)</sup>                      | -                        | -                          | -                                   | -                        | -                          |
| Sealing plugs for shipping                           | Not applicable, transport protection |                                  |                                      |                          |                            |                                     |                          |                            |

1) Not available for BVS connection head

2) Only for BSZ-H connection head

3) Not available for ½ NPT thread size cable entry

4) With appropriate mating connector connected

5) Suitable cable gland required for operation

## Transmitter built into the connection housing (option)

A transmitter can be mounted in an optional connection housing.



| Output signal 4 ... 20 mA and HART® protocol |           |           |
|--|-----------|-----------|
| Transmitter (selectable versions)            | Model T16 | Model T32 |
| Data sheet                                   | TE 16.01  | TE 32.04  |
| <b>Output</b>                                |           |           |
| ■ 4 ... 20 mA                                | x         | x         |
| ■ HART® protocol                             | -         | x         |
| <b>Explosion protection</b>                  | Optional  | Optional  |

For detailed specifications on the explosion protection of the transmitter, see respective transmitter data sheet.

## Accessories, connection housing

Pipe mounting kit, stainless steel (for field case)

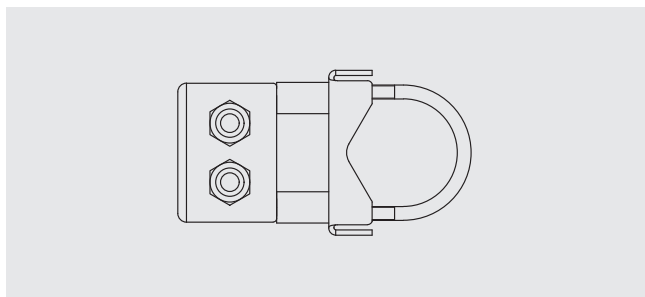

Pipe mounting kit, stainless steel (for 5/6000, DIH50/DIH52, TIF50/TIF52)

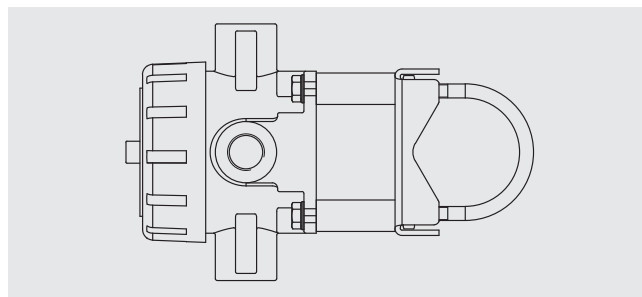

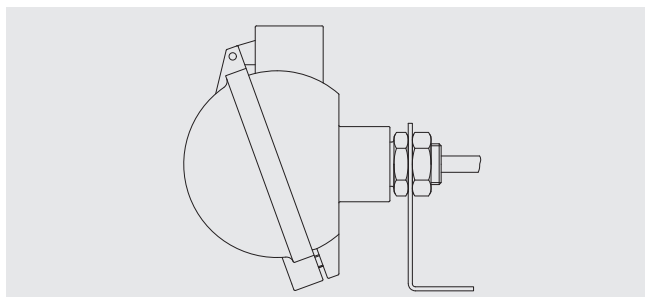

Fixing bracket (for wall mounting) 92 x 60 x 50 mm, stainless steel (for connection head models BSZ and BSZ-H)

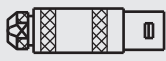

## Connector (option)

Cable thermocouples can be supplied with connectors fitted.  
The following options are available:

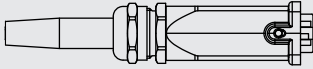
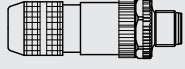
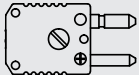
| Illustration  | Model  |
|---|--|
|  | Lemos connector (male)                         |
|  | Binder/Amphenol screw/plug-in connector (male) |
|  | Harting connector (male)                       |
|  | Binder screw/plug-in connector, M12 x 1 (male) |
|  | Thermo connector (male)                        |

The figures are not to scale.

## Ingress protection per IEC/EN 60529

### Degrees of protection against solid foreign bodies (defined by the 1st index number)

| First index number | Degree of protection / Short description | Test parameters  |
|--------------------|--|------------------|
| 5                  | Dust-protected                           | per IEC/EN 60529 |
| 6                  | Dust-tight                               | per IEC/EN 60529 |

### Degrees of protection against water (defined by the 2nd index number)

| Second index number | Degree of protection / Short description                      | Test parameters  |
|---------------------|---|------------------|
| 4                   | Protected against splash water                                | per IEC/EN 60529 |
| 5                   | Protected against water jets                                  | per IEC/EN 60529 |
| 6                   | Protected against strong water jets                           | per IEC/EN 60529 |
| 7                   | Protected against the effects of temporary immersion in water | per IEC/EN 60529 |
| 8                   | Protected against the effects of permanent immersion in water | as agreed upon   |

Model TC40 is available in the following IP degrees of protection:

- IP40
- IP50
- IP54 (standard)
- IP65
- IP67

The specified degrees of protection apply under the following conditions:

- Use of a suitable cable gland
- Use of a cable cross-section appropriate for the gland or select the appropriate cable gland for the available cable
- Adhere to the tightening torques for all threaded connections

### Classification of the IP protection zones of the probe

- Version with connection cable

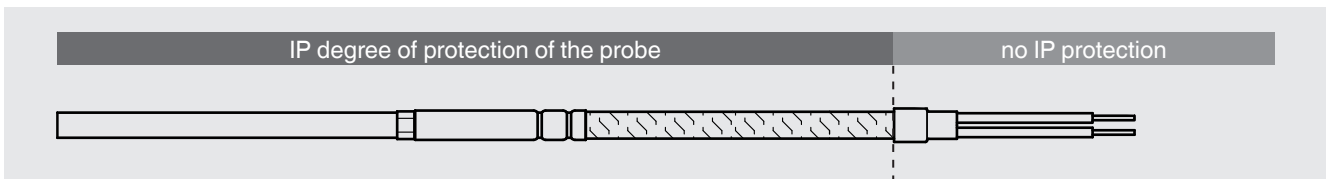

- Version with connection housing, fitted at the cable end

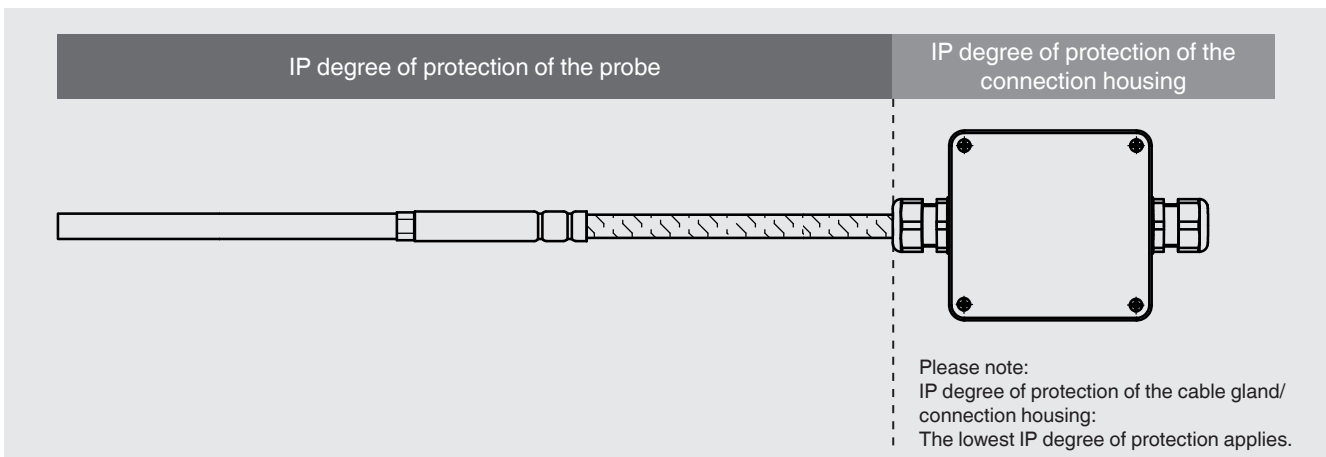

- Version with connector, fitted at the cable end

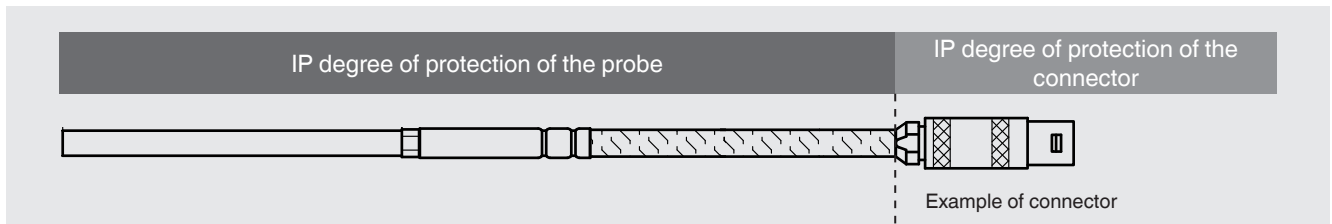

- Version with connector, fitted at the MI cable

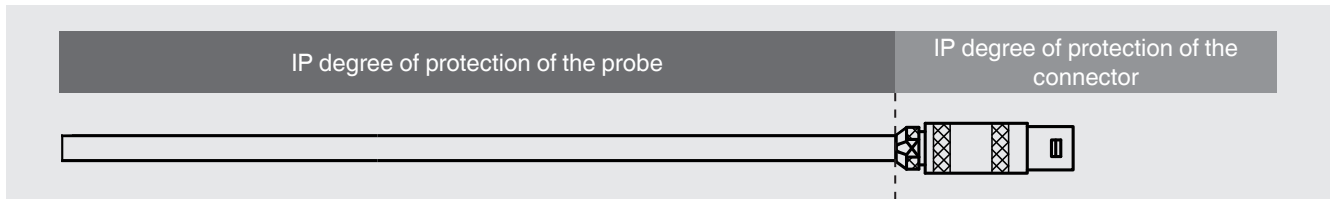

### IP ingress protection types of the connection housing

| Connection housing | Version                   | IP ingress protection |
|--------------------|---------------------------|-----------------------|
| Field case         | Plastic (ABS) / aluminium | IP65                  |
| Connection head    | KN4-A                     | IP65                  |
|                    | KN4-P                     |                       |
|                    | BSZ                       |                       |
|                    | BSZ-H                     |                       |
|                    | 1/4000                    | IP66                  |
|                    | 5/6000                    |                       |
|                    | 5/6000 with DIH50         |                       |
| 7/8000             | IP66                      |                       |
| 7/8000 with DIH50  |                           |                       |
| Field transmitter  | TIF50/TIF52               | IP66                  |

### IP ingress protection types of the connector

| Connector        | Version                   | IP ingress protection |
|------------------|---------------------------|-----------------------|
| Binder           | Series 680                | IP40                  |
|                  | Series 692                |                       |
|                  | Series 423                |                       |
| Amphenol         | C16-3                     | IP40                  |
| Lemosa           | Size 0 S                  | IP50                  |
|                  | Size 1 S                  |                       |
|                  | Size 2 S                  |                       |
|                  | Size 1 E                  | IP65                  |
| Harting          | 7D                        | IP65                  |
|                  | 8D                        |                       |
|                  | 8U                        |                       |
| M12 x 1          | 4-pin                     | IP65                  |
| Thermo connector | 2-pin, standard/miniature | IP00                  |
|                  | 3-pin, standard/miniature |                       |



# Electrical connection

## Without connector

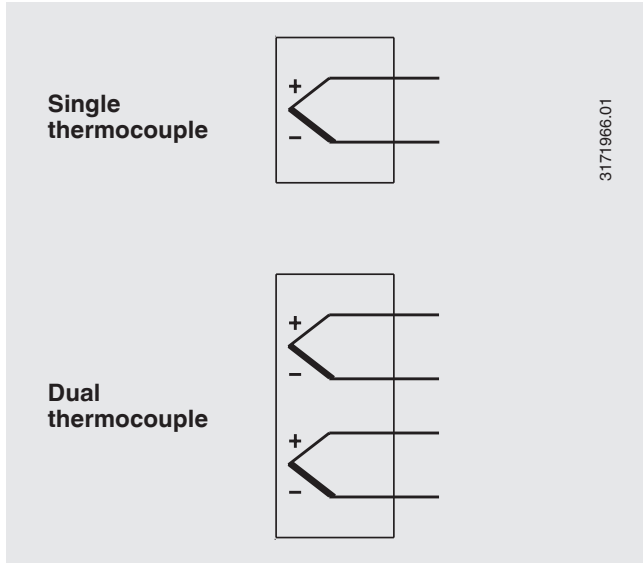

## Lemosa connector

max. permissible temperature range: -55 ... +250 °C

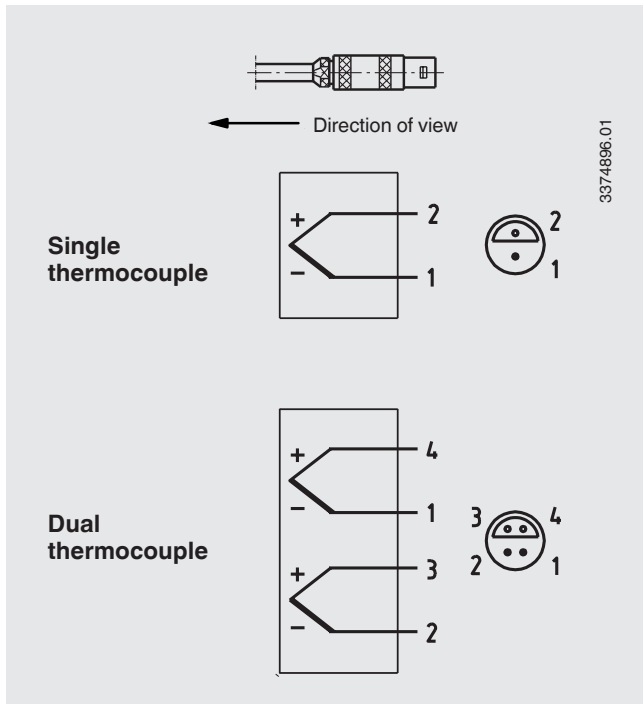

## Screw/plug-in connector (Amphenol, Binder) Series 680, series 423 (shielded)

max. permissible temperature range: -40 ... +85 °C

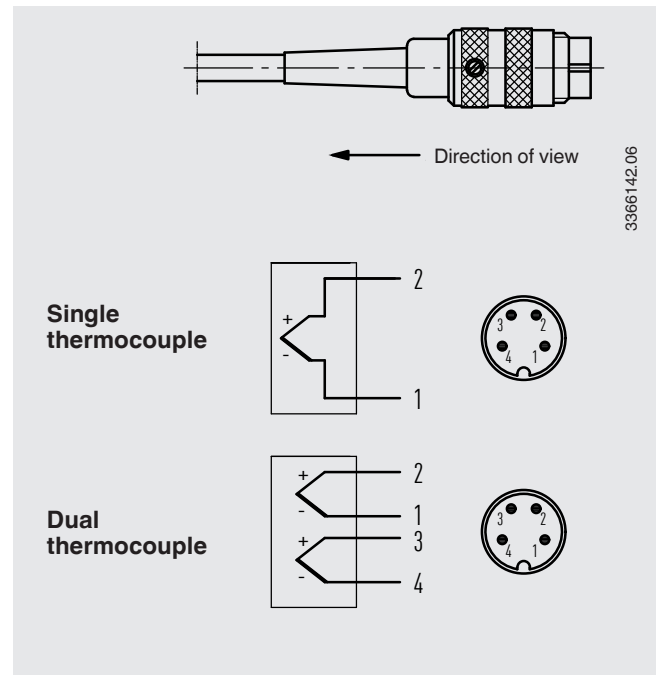

**Thermo connector (male)**

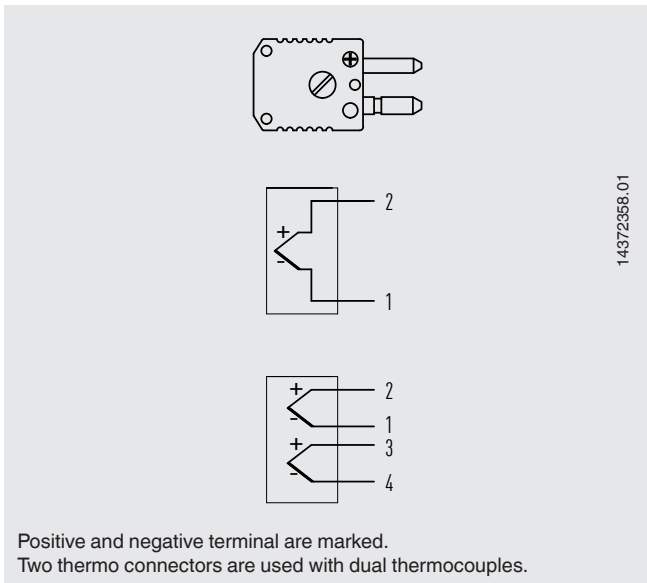

**Binder screw/plug-in connector (male), M12 x 1 (series 713)**

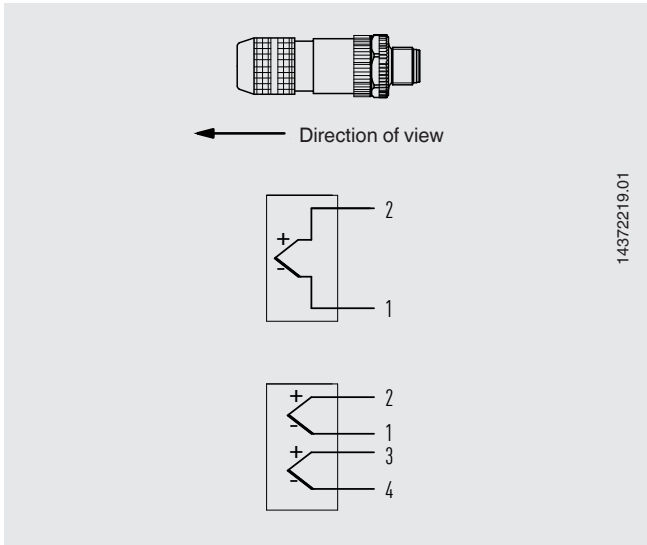

**Harting connector**

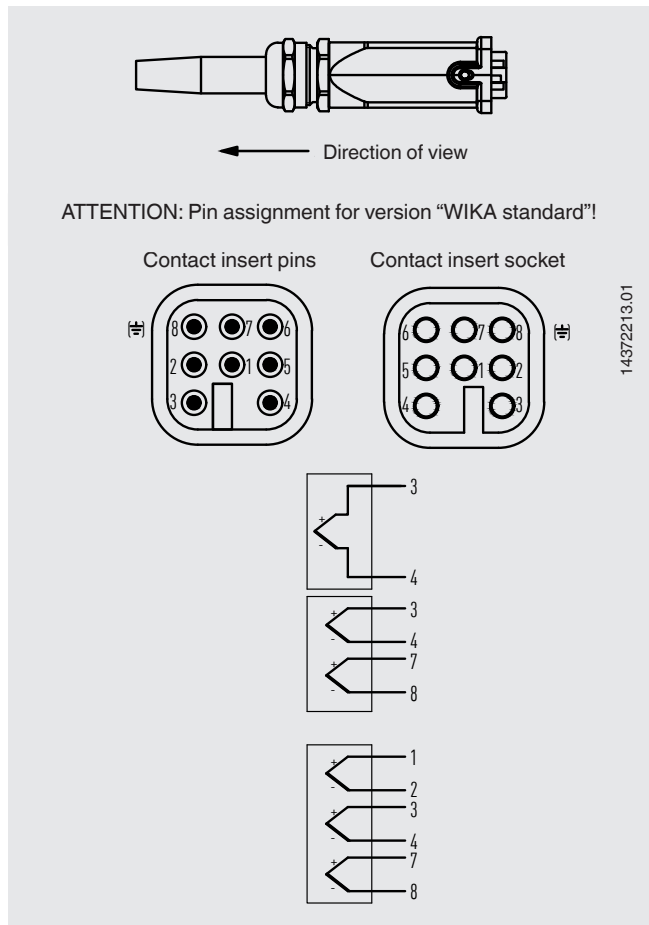

**Standard terminal block**

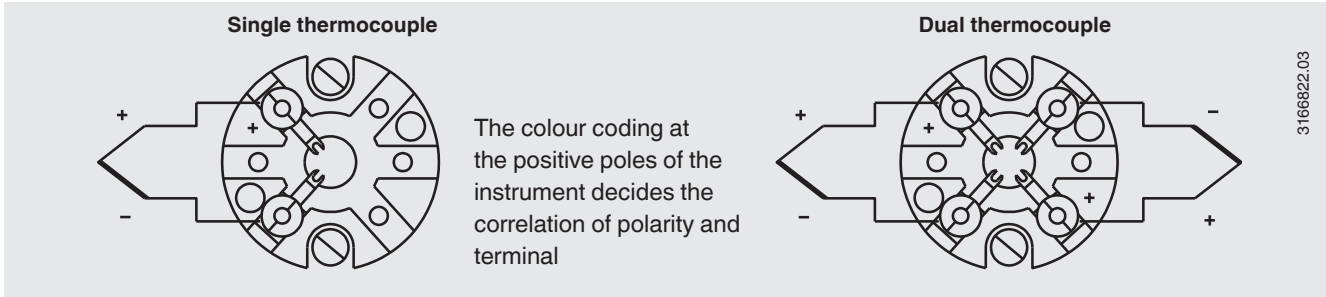

For the electrical connections of built-in temperature transmitters see the corresponding data sheets or operating instructions.

**Rack-mounting terminals**

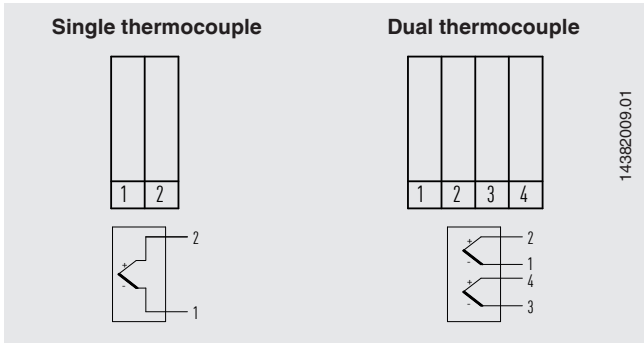

## Operating conditions

### Mechanical requirements

| Version  |                                       |
|----------|---------------------------------------|
| Standard | max. 50 g peak-to-peak, 10 ... 500 Hz |

The information on vibration resistance refers to the probe tip.

### Storage temperature

-40 ... +80 °C

Other storage temperatures on request

## Shipping information

Model TC40 thermocouple in "straight" version, with lengths > 1,100 mm is wound and delivered in coils.

## Certificates (option)

| Certification type                | Measurement accuracy | Material certificate |
|-----------------------------------|----------------------|----------------------|
| 2.2 test report                   | x                    | x                    |
| 3.1 inspection certificate        | x                    | x                    |
| DKD/DAkkS calibration certificate | x                    | -                    |

The different certifications can be combined with each other.

The minimum length (metal part of the probe or the length of the probe below the process connection) for carrying out a measurement accuracy test 3.1 or DKD/DAkkS is 100 mm.

## Ordering information

Model / Explosion protection / Probe version / Threaded connection version / Thread size / Materials / Probe diameter / Measuring element / Connection method / Temperature range / Connection cable, jacket / Lead ends version / Certificates / Options

© 10/2008 WIKA Alexander Wiegand SE & Co. KG, all rights reserved.  
The specifications given in this document represent the state of engineering at the time of publishing.  
We reserve the right to make modifications to the specifications and materials.