

NSC одноступенчатые насосы двухстороннего всасывания
с горизонтальным разъемом корпуса

Каталог продукции

(50HZ)







Вода жизненно необходима для всех форм жизни. Вместе с ростом мирового населения, растёт и потребность в современных качественных системах очистки воды, ирригации, дренажа и очистки сточных вод. Рост промышленного производства, столь жизненно необходим для экономической стабильности во всем мире и должен применять ответственные, безопасные, эффективные методы утилизации отходов в целях соблюдения требований регулирующих органов и охраны окружающей среды, в которой мы живем, от загрязнения воды и воздуха. CNP помогло многим компаниям в достижении этой цели, благодаря десятилетиям опыта, включающего сложное планирование, инженерных и других вспомогательных систем для насосных станций по всему миру. Инновационные решения для работы с жидкостями, которые повышают надежность при одновременном снижении затрат на потребление энергии и техническое обслуживание, сокращают выбросы углекислого газа, а также обеспечивают то, на чём основывается репутация CNP.

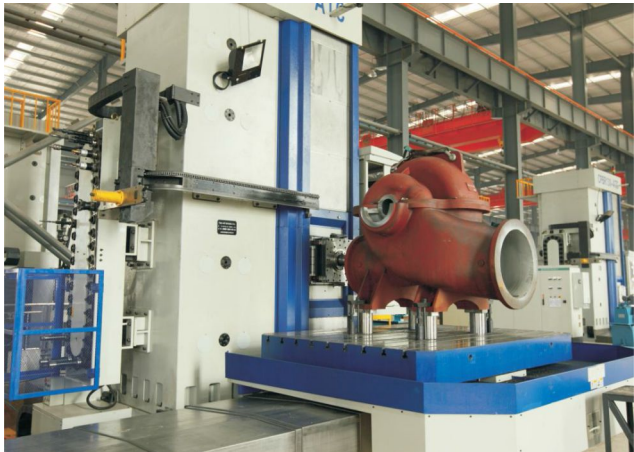

Содержание

Краткое описание	
Применение	6
Характеристики	6
Обозначение	6
Устройство	6
Подшипник	6
Особенности конструкции	7
Расположение насоса и двигателя	
Горизонтально	8
Вертикально	8
Направление вращения и направление потока	8
Стандартные материалы	9
Технические данные	
Диаметр вала, уплотнение вала и подшипник	9
Пределы давления	11
Рабочее колесо, Силы и момент в сопле	12
Скорости	13
Вибрации	13
Технические характеристики	13
Установка	
Уплотнение трубопроводов	14
Газоотводные соединения и датчик температуры подшипника	14
Сечения	
Горизонтальная установка	15
Вертикальная установка	16
Уплотнение вала	16
Ротор	19
Подшипник	20
Диапазоны производительности	23
Графики производительности	25
Размеры	
Размеры насоса с открытым валом	110
Размеры стандартных фланцев	112
Размеры горизонтального насоса NSC с двигателем	115
Размеры вертикального насоса NSC с двигателем	119
Рекомендуемые запасные части	121
Комплектация	122
Гарантия, проверка и контроль качества	122
Данные для заказа	122

Краткое описание

Применение

- Чистая вода или среда, подобная воде по физико-химическим свойствам
 Водоснабжение Дренаж Ирригация Электростанции
 Гидроэлектростанции Пожаротушение Кондиционирование воздуха
 Строительство
 Морское применение Любые типы воды в промышленных процессах
- Абразивная среда
 Вода с песком Вода с окалиной Прочее
- Коррозионная среда
 Опреснение Солёная морская вода Прочее
- Высокотемпературная среда
 Вода сети горячего водоснабжения Все типы химических жидкостей
- Нефтяные и химические жидкости (в соответствии с API610 BB1)
 Сырая и очищенная нефть Погрузка и выгрузка на нефтяных терминалах
 Все типы химических жидкостей

Характеристики

Расход	Q: 50~20000 m ³ /h
Напор	H: 10~230 m
Впускной диаметр	DN: 100~1400 mm
Выпускной диаметр	DN: 80~1200 mm
Рабочее давление	P: J 5 MPa
Рабочая температура t:	-15°C~+ 200°C(выше 80°C проконсультируйтесь с CNP)
Концентрация абразивной среды:	J 4%

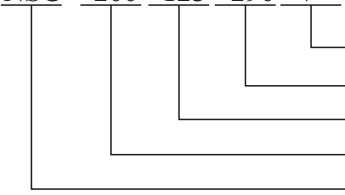
Обозначение	NSC -200 -125 -290 V	
		Вертикальный (Если нет "V" то горизонтальный)
		Номинальный диаметр рабочего колеса (mm)
		Диаметр выходного патрубка (mm)
		Диаметр входного патрубка (mm)
		Серия

Конструкция

NSC одноступенчатый, со спиральным разделяемым по оси корпусом насос, с двойным всасывающим рабочим колесом, для горизонтального и вертикального монтажа. Вал привода горизонтального насоса, по выбору, может быть выведен с левой или с правой стороны. Отверстия во фланцах выполнены по GB, ISO, DIN, BS или ANSI.

Подшипники

Горизонтальный: С обеих сторон шариковые подшипники, смазываемые консистентной смазкой, как вариант, смазываемые маслом. Для насосов большого размера доступны подшипники скольжения.
 Вертикальный: Шариковые подшипники, смазываемые консистентной смазкой

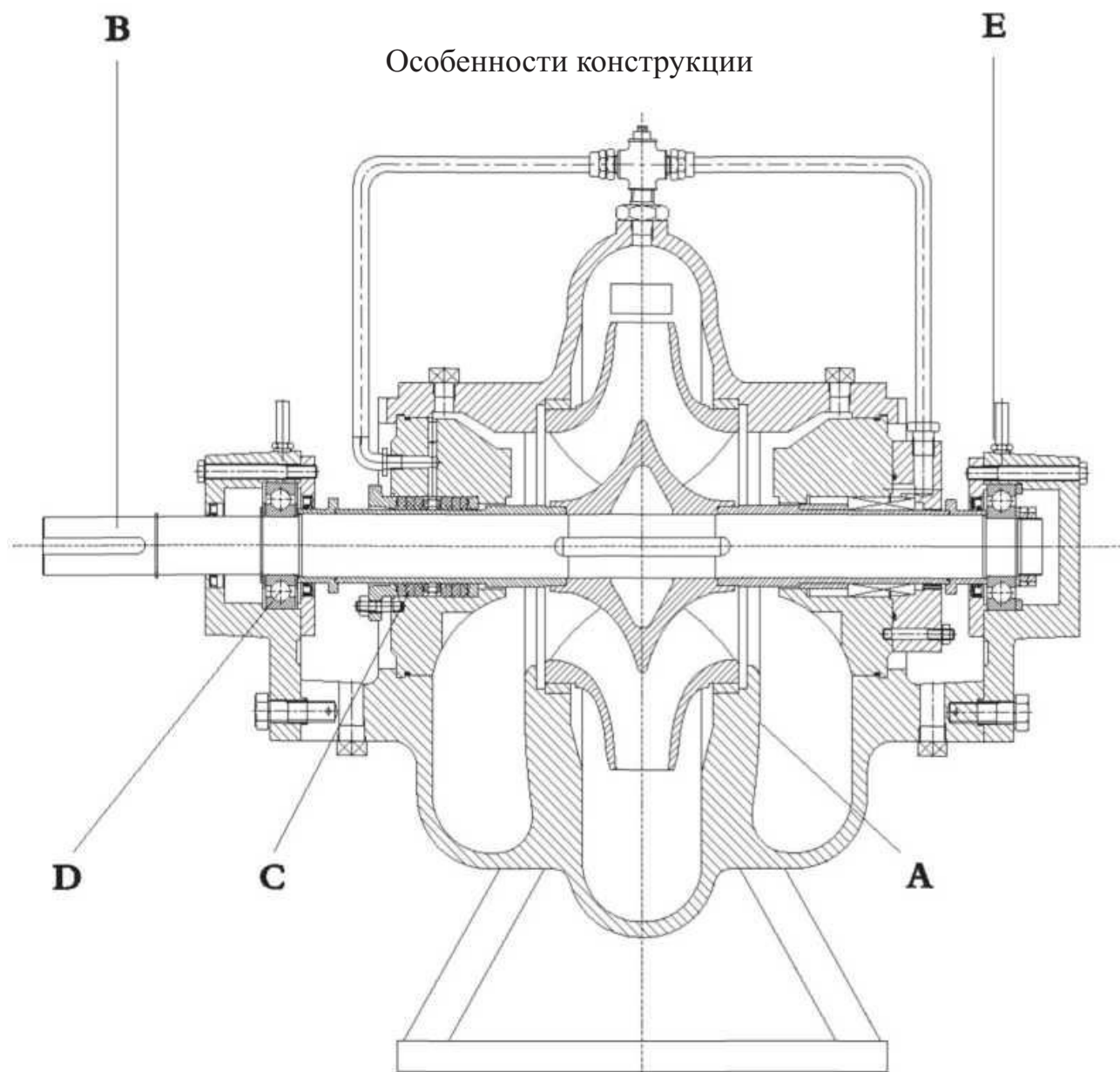
**А. Корпус**

- a. Линейная, разделяемая по оси конструкция, которая позволяет полностью вынуть рабочее колесо без перемещения трубопроводов и двигателя.
- b. Малые расстояния между подшипниками
- c. Герметичность, благодаря компактному фланцевому соединению с длинными преднапряжёнными болтами.
- d. Возможно встречное вращение с аналогичными частями.
- e. Корпус двойная спираль, уменьшающий радиальные силы на рабочее колесо и, следовательно, нагрузку на подшипники.
- f. Легко устанавливаемая самовыравнивающаяся верхняя крышка.
- g. Отверстия во фланцах по ISO, DIN, BS или ANSI
- h. Гладкая внутренняя поверхность с эпоксидным покрытием в соответствии с требованиями.
- i. Сменные компенсационные кольца, поддерживающие зазор между рабочим колесом и корпусом.
- j. Энергоэффективность и низкий NPSH.
- k. Высокопрочная конструкция корпуса для высоких рабочих давлений.

В. Рабочее колесо

- a. Компьютерно-оптимизированные двойные рабочие колёса.
- b. Минимальное осевое усилие благодаря двойному рабочему колесу.
- c. Рабочее колесо статически и динамически сбалансировано согласно ISO1940
- d. Опционально компенсационные кольца для рабочего колеса
- e. Новый проходной стабилизатор с отличными гидравлическими характеристиками и высокой производительностью, улучшенными за счет CFD.

С. Уплотнение

- a. Безасбестовые, мягко упакованные сальниковые корпуса пригодные для питьевой воды.
- b. Несбалансированное механическое уплотнение, согласно DIN 24960. Сбалансированное механическое уплотнение для рабочего давления > 16 Бар.
- c. Кассетное механическое уплотнение по необходимости

Д. Подшипник

- a. Подшипники качения с SKF покрытием и запечатанной консистентной антифрикционной смазкой для длительного срока службы.
- b. Открытый сальник, достаточно места для обслуживания.
- c. Опционально: масляная смазка через маслѐнку с постоянным уровнем

Е. Управление и защита

- a. Высокопрочный вал полностью герметичен и не намокает, что предотвращает коррозию.
- b. Вал короткий и жѐсткий, допускает незначительные вибрации.
- c. Наличие заменяемых защитных втулок вала
- d. Отсутствие элементов, подвергающихся воздействию перекачиваемой среды, длительный срок службы и отсутствие коррозии.
- e. Сборка, не требующая регулировки.
- f. Быстрый и простой монтаж / демонтаж компонентов ротора за счет упругого преднапряжённого крепления.
- g. Максимальная взаимозаменяемость конструкций валов всей серии для 2900 оборотов в минуту и модели на 1450 оборотов в минуту, всего шесть валов и шесть подшипниковых сборок.

Расположение насоса и двигателя

Горизонтальное

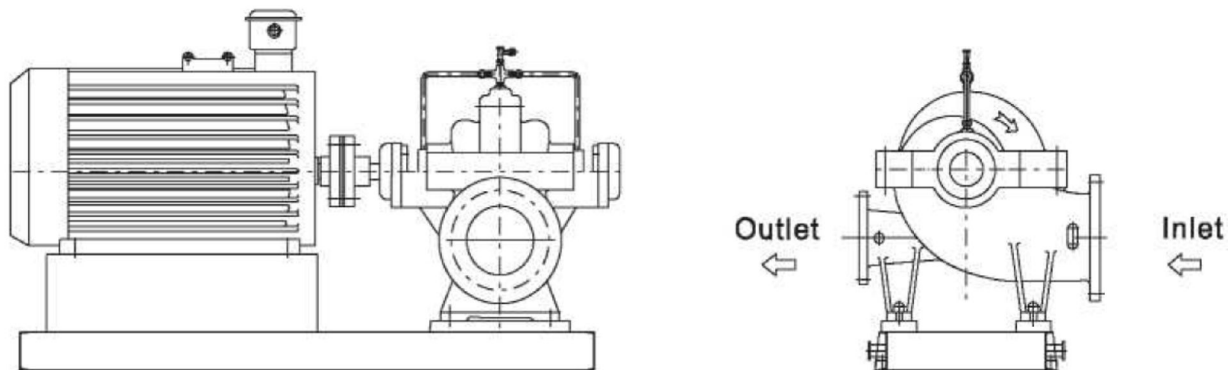

Вертикальное

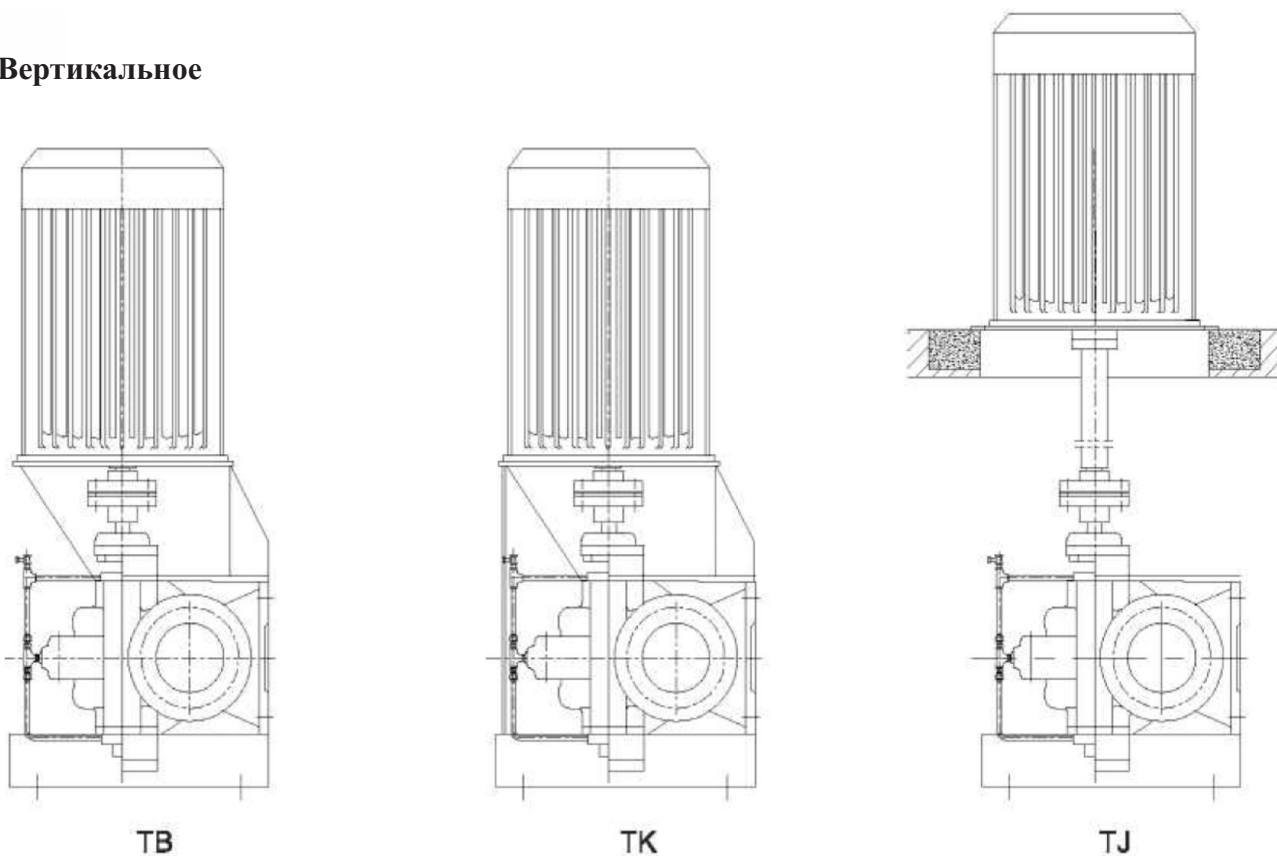

Примечание: CNP выбирает ТВ или ТК в зависимости от размера мотора.
 Направление вращения и направление потока

Горизонтальное

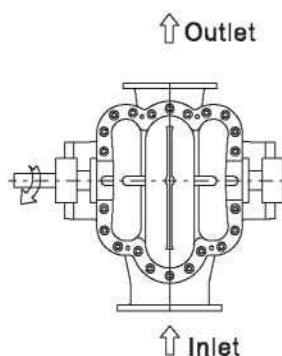
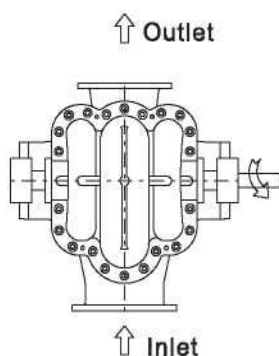

Вертикальное

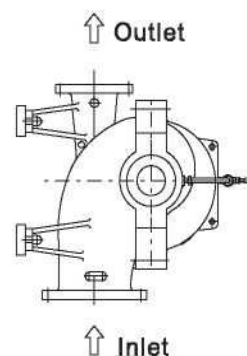
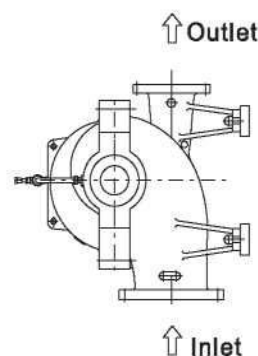

Стандартные материалы

Среда Наименование	Чистая вода	Вода с грязью и песком/ Вода с окалиной /Сточные воды/ Солёная вода	Морская вода	Горячая вода	Нефтехими- ческие жидкости
Корпус	Чугун	Никель-хромовый чугун /Износостойкий чугун /Литая сталь + износостойкое покрытие	Дуплексная нержавеющая сталь	Ковкий чугун / Литая сталь / Нержавеющая сталь	Согласно API610 1-1, 1-2, S-5, S-8, C-6, A-7, A-8, D-1, D-2
Рабочее колесо	Чугун/Бронза/ Нержавеющая сталь	Ковкий чугун/SS420/ Нержавеющая сталь	Дуплексная нержавеющая сталь	SS420/ Нержавеющая сталь	
Корпус подшипника	Чугун	Чугун	Чугун	Чугун	
Вал	SS420	SS420	Дуплексная нержавеющая сталь	SS420/ Нержавеющая сталь	
Компенса- ционные кольца	Чугун	Ковкий чугун/SS420	Бронза / Дуплексная нержавеющая сталь с упрочняющей обработкой	Ковкий чугун / Литая сталь	
Втулки вала	SS420	SS420	Дуплексная нержавеющая сталь	SS420	
Сальники вала	Набивка/ Механическое уплотнение	Набивка/ Механическое уплотнение	Механическое уплотнение	Механическое уплотнение	
Промывка трубопроводов	Q235-A	Q235-A	316L	Q235-A/Нержавеющая сталь	

Технические параметры

Диаметр вала, уплотнение вала и подшипник

Единицы: мм, если не указано другое

Модель	Ø Вала	Номинальный Ø патрубков	Герметичная камера D	Герметичная камера L	Подшипник	Торцевое уплотнение	Тип насоса
NSC125-80-210	35	50	75	72	6307 SKF	M74N/50-G92-Q2BVGG (Торцевое уплотнение тип B)	Горизонтального исполнения тип C
NSC125-80-270							
NSC125-80-350							
NSC150-100-250							
NSC150-100-320							
NSC150-100-400							
NSC150-100-400G	40	55	75	72	NU 6308 /6308 SKF	H75N/55-G92-Q2BVGG (Торцевое уплотнение тип B)	Горизонтального исполнения тип C
NSC200-125-240	45	60	85	82	6309 SKF	M74N/60-G92-Q2BVGG (Торцевое уплотнение тип B)	Горизонтального исполнения тип C
NSC200-125-300							
NSC200-125-380							
NSC200-125-480							
NSC200-150-290							
NSC200-150-360							
NSC200-150-460	55	70	95	85	6311 SKF	M74N/70-G92-Q2BVGG (Торцевое уплотнение тип B)	Горизонтального исполнения тип C
NSC200-150-570							
NSC250-200-340							
NSC250-200-430							
NSC300-250-270							
NSC300-250-280							
NSC250-200-530	65	80	110	93	6313 FAG	M74N/80-G92-Q2BVGG (Торцевое уплотнение тип B)	Горизонтального исполнения тип C
NSC250-200-660							
NSC300-250-390							
NSC350-300-310							
NSC350-300-330							
NSC350-300-400							
NSC300-250-490	75	90	120	92	6315 SKF	M74N/90-G92-Q2BVGG (Торцевое уплотнение тип A)	Горизонтального исполнения тип C
NSC300-250-610							
NSC400-300-450							
NSC400-350-360							
NSC400-350-380							
NSC450-450-350							
NSC500-400-400							
NSC500-400-420							

Модель	Ø Вала	Номинальный Ø патрубков	Герметичная камера D	Герметичная камера L	Подшипник	Торцевое уплотнение	Тип насоса
NSC600-500-550 NSC600-500-580	80	115	160	170	6320 SKF	M74N/115-G92-Q2BVGG (Торцевое уплотнение тип А)	Горизонтального исполнения тип А
NSC300-250-780	85	110	150	130	NU318/6318 SKF	H75N/110-G92-Q2BVGG (Торцевое уплотнение тип А)	Горизонтального исполнения тип В
NSC400-300-570	85	110	150	130	6317 FAG	M74N/110-G92-Q2BVGG (Торцевое уплотнение тип А)	Горизонтального исполнения тип В
NSC400-300-700							
NSC400-350-520							
NSC500-400-500							
NSC500-400-590							
NSC500-400-675							
NSC700-700-500							
NSC600-500-470 NSC600-500-520	95	115	160	170	6320 FAG	M74N/120-G92-Q2BVGG (Торцевое уплотнение тип А)	Горизонтального исполнения тип А
NSC500-400-540	100	135	180	150	NU321/6321 SKF	M74N/135-G92-Q2BVGG (Торцевое уплотнение тип А)	Горизонтального исполнения тип В
NSC500-400-660							
NSC500-300-790							
NSC600-400-740							
NSC600-450-640							
NSC700-500-670							
NSC700-600-600							
NSC700-600-680							
NSC500-300-780	115	150	195	180	2XNU324/6324 SKF	H75N/150-G92-Q2BVGG (Торцевое уплотнение тип А)	Горизонтального исполнения тип А
NSC500-300-920					NU324/6324 SKF	M74N/150-G92-Q2BVGG (Торцевое уплотнение тип А)	
NSC600-400-850							
NSC700-600-740							
NSC800-700-750	120	160	205	170	NU326/6326 SKF	M74N/160-G92-Q2BVGG (Торцевое уплотнение тип А)	Горизонтального исполнения тип В
NSC700-500-940	130	170	215	176	2XNU328/6328 NU328/2X6328 NU328/6328	M74N/170-G92-Q2BVGG (Торцевое уплотнение тип А)	Горизонтального исполнения тип А
NSC800-700-910							
NSC1000-800-940							

Допустимое рабочее давление

Модель	Допустимое рабочее давление (МПа)	Модель	Допустимое рабочее давление (МПа)
NSC125-80-210	1,6	NSC400-300-700	2,5
NSC125-80-270	1,6	NSC400-350-360	1,6
NSC125-80-350	1,6	NSC400-350-380	1,6
NSC150-100-250	1,6	NSC400-350-520	1,6
NSC150-100-320	1,6	NSC450-450-350	1,0
NSC150-100-400	1,6	NSC500-300-780	3,0
NSC150-100-400G	3,0	NSC500-300-920	2,5
NSC200-125-240	1,6	NSC500-400-400	1,6
NSC200-125-300	1,6	NSC500-400-420	1,6
NSC200-125-380	1,6	NSC500-400-500	1,6
NSC200-125-480	1,6	NSC500-400-540	1,6
NSC200-150-290	1,6	NSC500-400-590	1,0
NSC200-150-360	1,6	NSC500-400-660	2,5
NSC200-150-460	1,6	NSC500-400-675	1,0
NSC200-150-570	2,5	NSC600-400-740	1,6
NSC250-200-340	1,6	NSC600-400-850	1,6
NSC250-200-430	1,6	NSC600-450-640	1,6
NSC250-200-530	1,6	NSC600-500-470	1,0
NSC250-200-660	2,5	NSC600-500-520	1,0
NSC300-250-270	1,6	NSC600-500-550/580	1,0
NSC300-250-280	1,6	NSC700-500-670	1,6
NSC300-250-390	1,6	NSC700-500-940	2,5
NSC300-250-490	1,6	NSC700-600-600	1,0
NSC300-250-610	1,6	NSC700-600-680	1,0
NSC300-250-780	3,0	NSC700-600-740	1,6
NSC350-300-310	1,6	NSC700-700-500	1,0
NSC350-300-330	1,6	NSC800-700-750	1,0
NSC350-300-400	1,6	NSC800-700-910	1,6
NSC400-300-450	1,6	NSC1000-800-940	1,0
NSC400-300-570	1,6		

Примечание:

1. В моделях насосов с максимальным рабочим давлением по таблице 1.6 МПа и ниже, применяется материал для корпуса насоса НТ250; если давление превышает 1,6 МПа, используется высокопрочный чугун или лучшие материалы.

2. В моделях насосов с максимальным рабочим давлением по таблице в пределах 2.0 МПа, применяется материал корпуса НТ250, если максимальное рабочее давление более чем 2.0 МПа, материал корпуса изготавливается из высокопрочного чугуна или других высокопрочных материалов (обратитесь к ближайшему дилеру или представительство завода CNP).

Рабочее колесо, силы и крутящие моменты

Модель	Диаметр рабочего колеса (мм)		Допустимые усилия сопла F _x , F _y , F _z , N	Допустимый крутящий момент M _x , M _y , M _z , Нм		
	Свободный проход +/-10%	Макс. диаметр				
NSC125-80-210	30	216	800	500		
NSC125-80-270	25	270				
NSC125-80-350	22	345				
NSC150-100-250	30	254	1000	700		
NSC150-100-320	24	325				
NSC150-100-400	21	423				
NSC150-100-400G	21	423	1500	1000		
NSC200-125-240	48	250				
NSC200-125-300	37	301				
NSC200-125-380	35	395	2000	1500		
NSC200-125-480	29	491				
NSC200-150-290	52	290				
NSC200-150-360	44	370	2500	2000		
NSC200-150-460	35	460				
NSC200-150-570	32	585				
NSC250-200-340	57	338	3000	2750		
NSC250-200-430	52	426				
NSC250-200-530	40	530				
NSC250-200-660	38	665	4000	3000		
NSC300-250-270	119	302				
NSC300-250-280	96	321				
NSC300-250-390	70	395				
NSC300-250-490	60	490				
NSC300-250-610	45	610				
NSC300-250-780	42	770				
NSC350-300-310	132	310				
NSC350-300-330	101	350				
NSC350-300-400	81.6	425				
NSC400-300-450	81	450	5000	3000		
NSC400-300-570	67	580				
NSC400-300-700	65	700				
NSC400-350-360	149	360				
NSC400-350-380	122	415				
NSC400-350-520	90	558	5600	3200		
NSC450-450-350	161	350				
NSC500-300-780	81	780				
NSC500-300-920	85.4	920				
NSC500-400-400	180.6	412				
NSC500-400-420	180	425				
NSC500-400-500	166.1	498				
NSC500-400-540	105	545				
NSC500-400-590	105	545				
NSC500-400-660	84.9	666				
NSC500-400-675	84.9	666	6900	3800		
NSC600-400-740	99	740				
NSC600-400-850	102	860				
NSC600-450-640	128	650	8800	4900		
NSC600-500-470	175	520				
NSC600-500-520						
NSC600-500-550	243	580				
NSC600-500-580						
NSC700-500-670	103.5	610	10700	6300		
NSC700-500-940					128.5	940
NSC700-600-600					103.5	610
NSC700-600-680					240	702
NSC700-600-740					146	780
NSC700-700-500	246	522	12600	7100		
NSC800-700-750	315.9	750				
NSC800-700-910	196	920				
NSC1000-800-940	291	940				

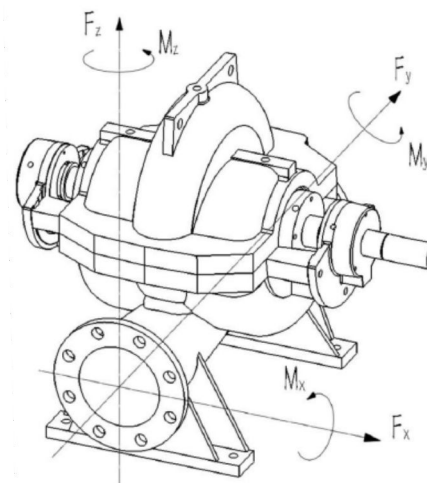

Примечание: Значения действительны для чугунных материалов корпуса, для корпусов из ковкого чугуна применяют 1,4-кратное значение и для литой стали 1,7-кратное значение. Если требуется размер насоса, который не показан в приведенной выше таблице, пожалуйста, свяжитесь с CNP.

Скорости

Диаграмма производительности показывает рабочий диапазон насоса, для более высоких скоростей, проконсультируйтесь с CNP.

Вибрации

1. Нормальный рабочий диапазон насоса — это 0.4~1.25 от номинальной мощности.
2. Вибрации насоса по ISO 2372-1974.

Характеристики окраски

	Внутри	Снаружи
Предварительная обработка	Струйная обработка (2 раза)	
Грунтовка	Эпоксидная цинковая грунтовка	
Финишное покрытие	Влажные части используют Interzone 954 или эпоксидную цинковую грунтовку	Акриловая эмаль Обычные NSC: RAL5015(Синий) Пожарные насосы: RAL3000(Красный)

Примечание: Суперлегкое энергосберегающее, износостойкое или антикоррозийное и другие покрытия доступны в соответствии с различными средами, применением и требованиями заказчика и заказываются за дополнительную плату.

Монтаж

Трубы гидроуплотнения

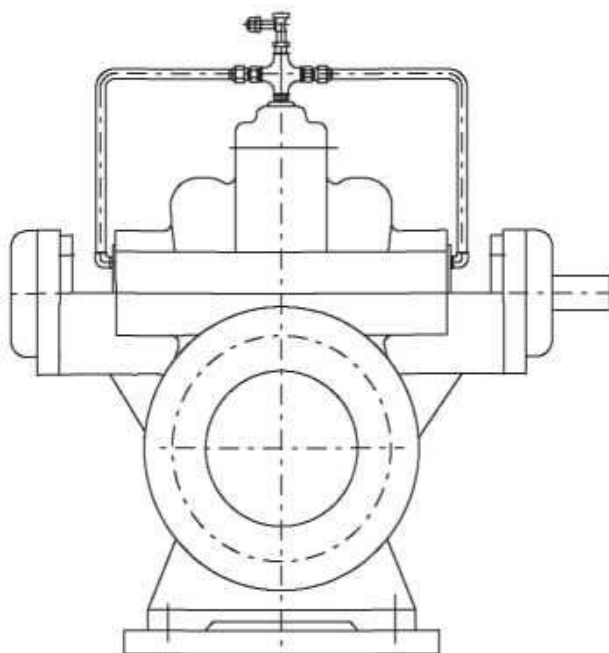

01 Трубопроводы промывки корпуса сальника

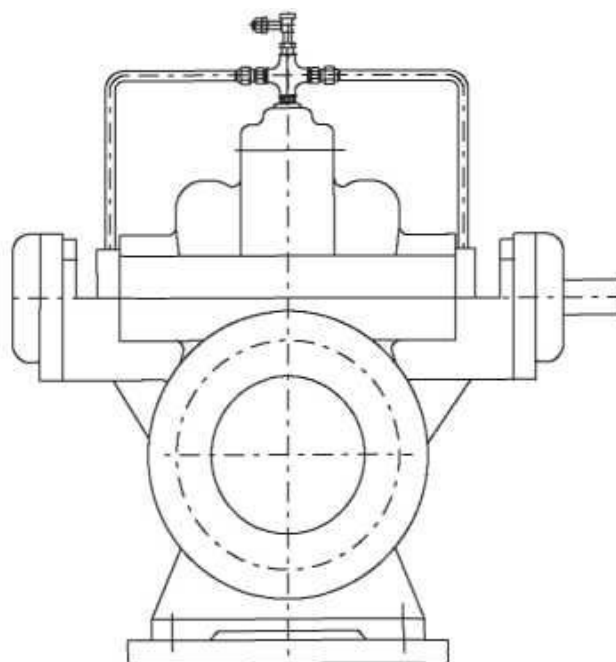

02 Трубопроводы промывки торцевого уплотнения

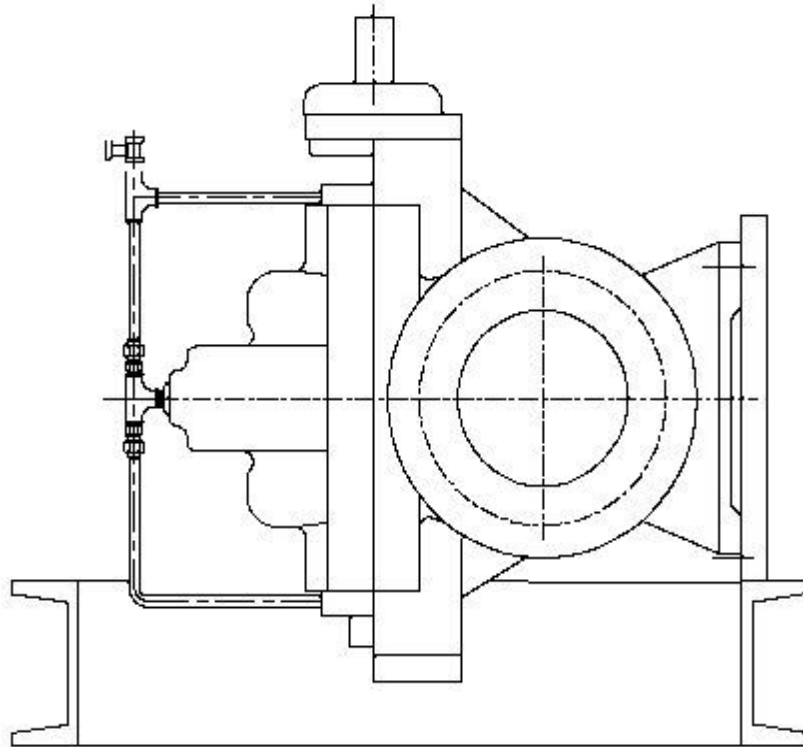

03 Торцевое уплотнение и промывочные трубопроводы для подшипника трансмиссионного вала

**Газоотводные соединения и датчик температуры подшипника
(Воздушные вентили доступны как аксессуары)**

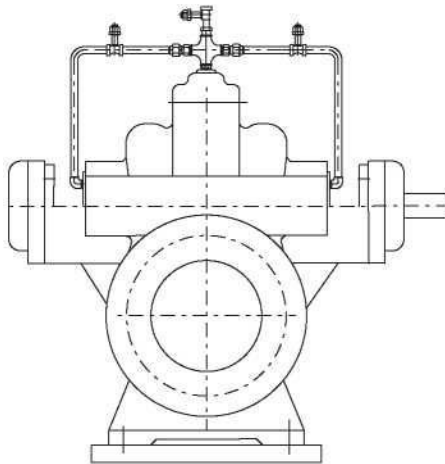

04 Промывочный водовод сальника с выпускным клапаном

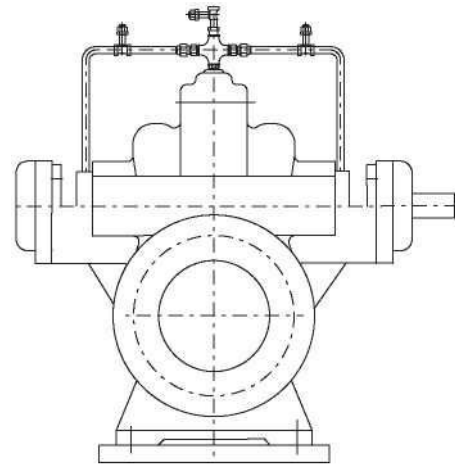

05 Промывочный водовод торцевого уплотнения с выпускным клапаном

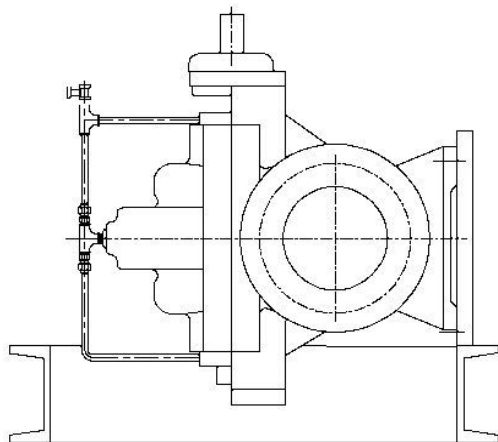

06 Промывочный водовод и выпускной клапан (вертикальная установка)

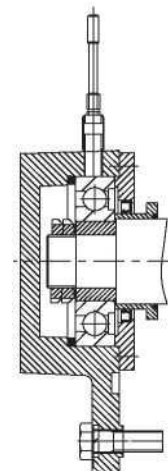

07 Датчик температуры подшипника (PT100)

Насос NSC — Вид в разрезе

Горизонтальная установка

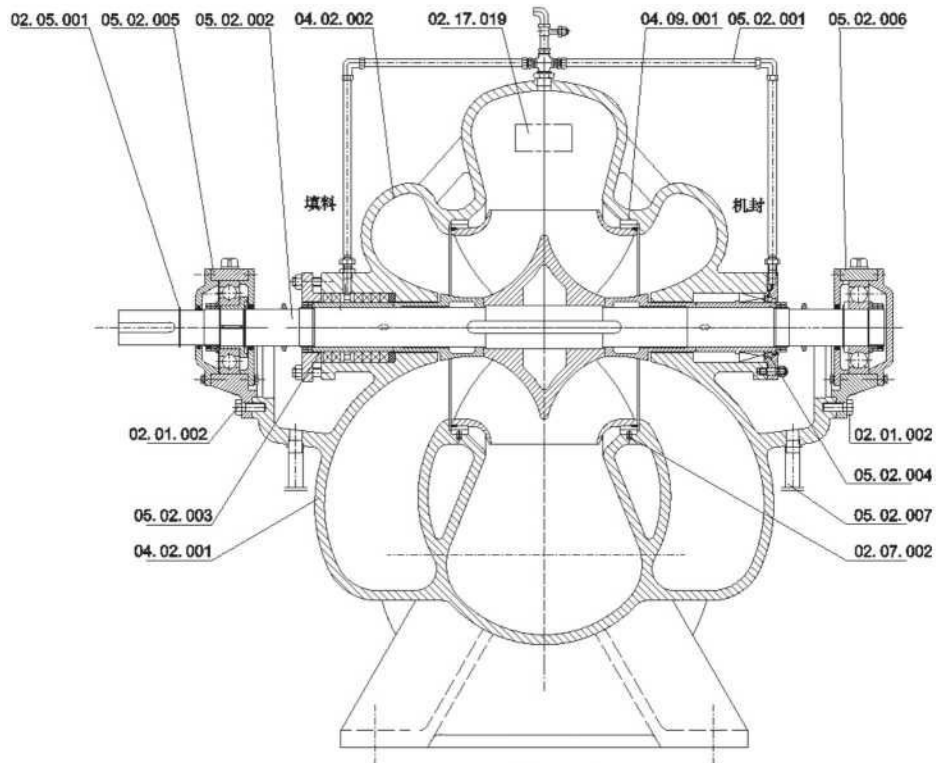

▲ Type A

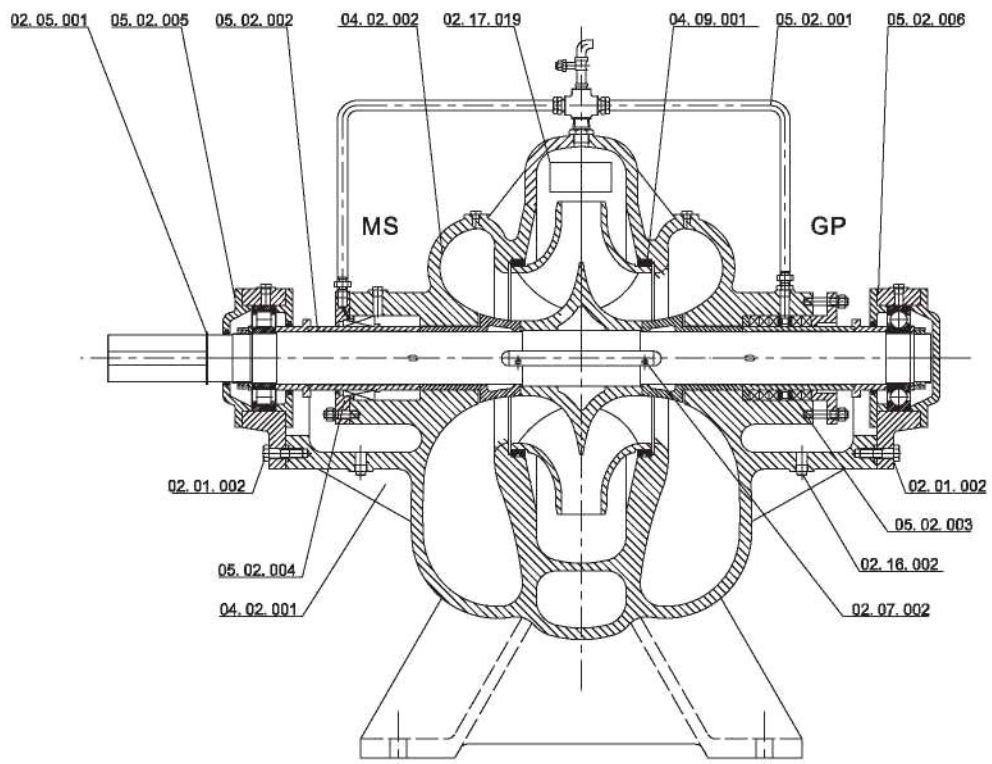

▲ Type B

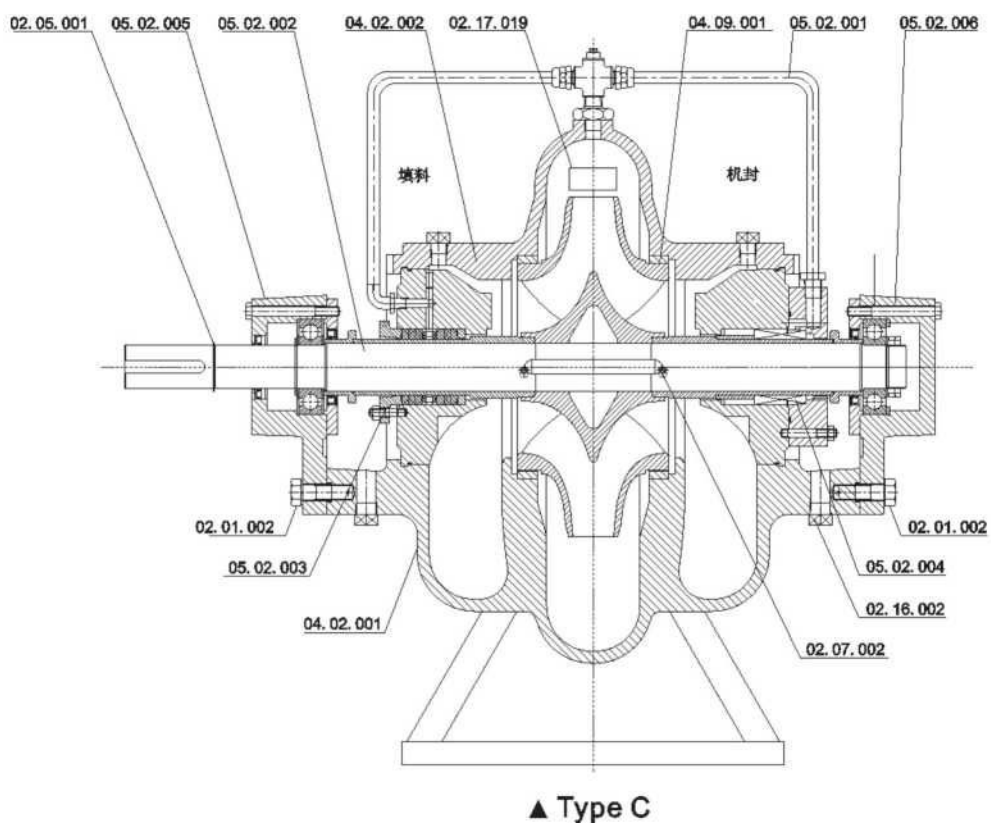

Вертикальная установка

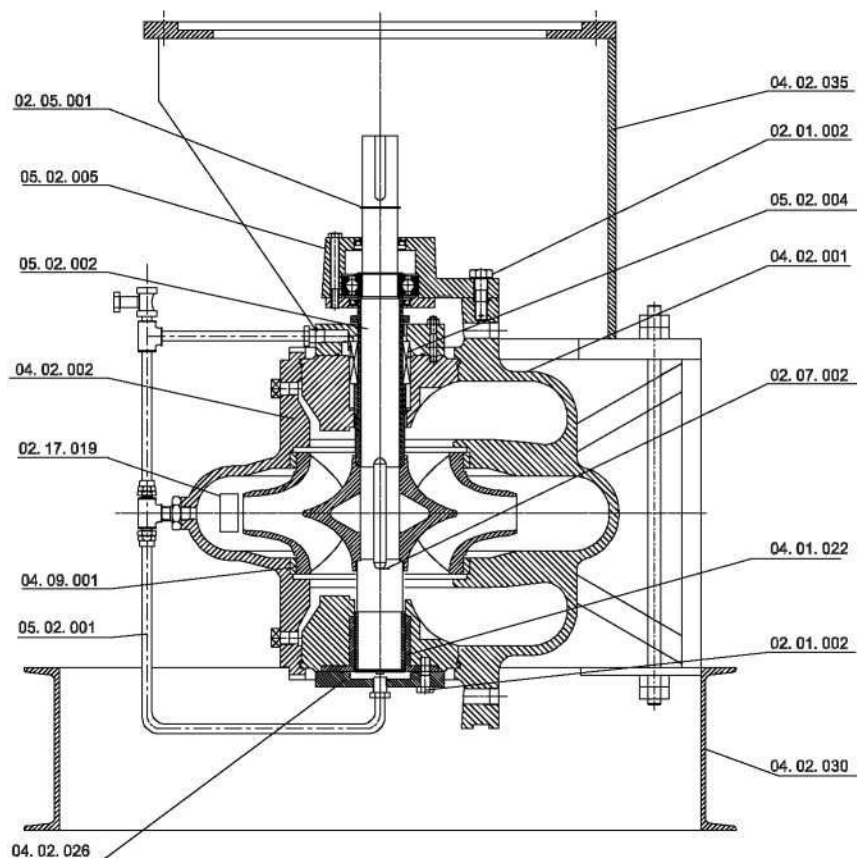

Сальник вала — Вид в разрезе

1. Корпус сальника с мягкой набивкой

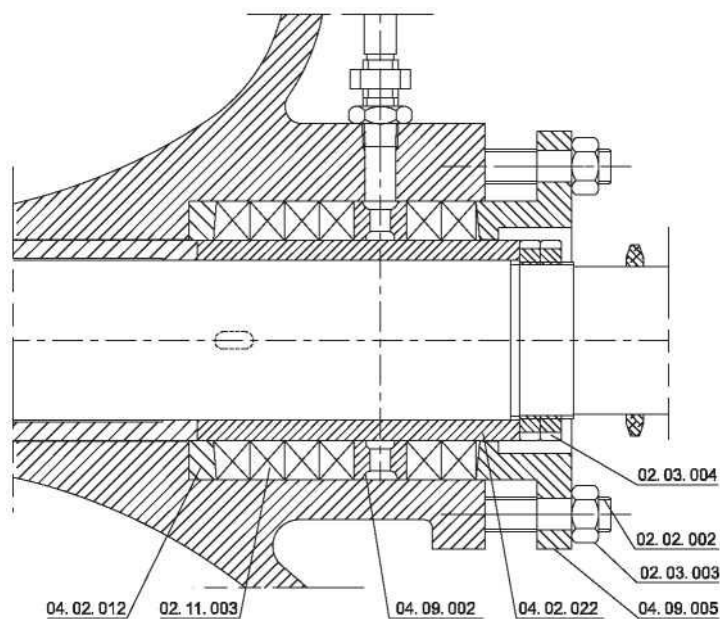

№ Детали	Наименование
04.02.012	Набор горловинных колец
02.11.003	Набивка сальника
04.09.002	Фонарное кольцо
04.02.022	Защитная втулка вала
04.09.005	Сальник
02.03.003	Гайка
02.02.002	Болт
02.03.004	Круглая шлицевая гайка

Тип А—Используется для горизонтальных установок тип А и тип В

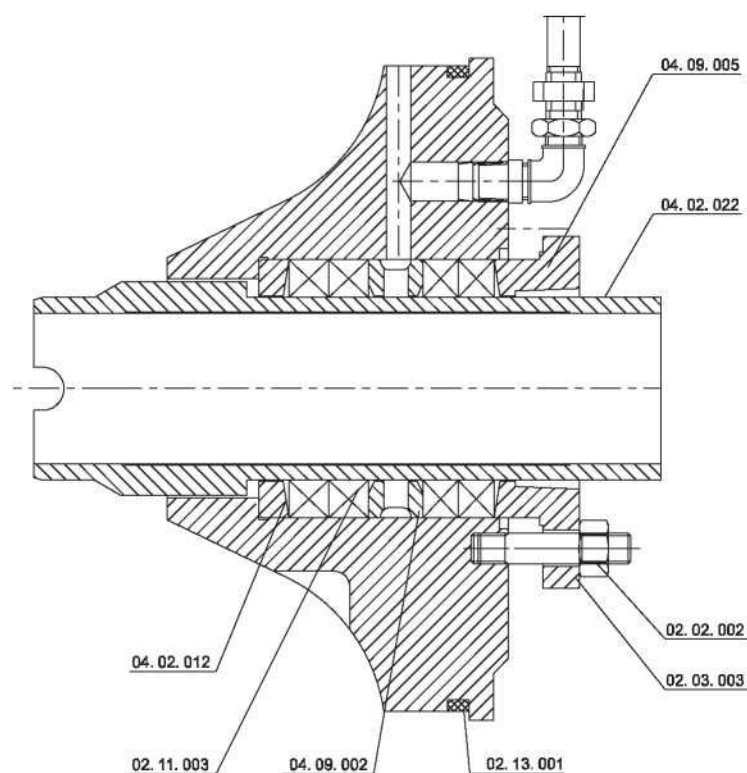

№ Детали	Наименование
04.09.005	Сальник
04.02.022	Защитная втулка вала
04.02.012	Набор горловинных колец
02.11.003	Пакет сальников
04.09.002	Фонарное кольцо
02.13.001	Уплотнительное кольцо круглого сечения
02.02.002	Болт
02.03.003	Гайка

Тип В—Применяется в горизонтальных установках тип С

2. Торцевое уплотнение

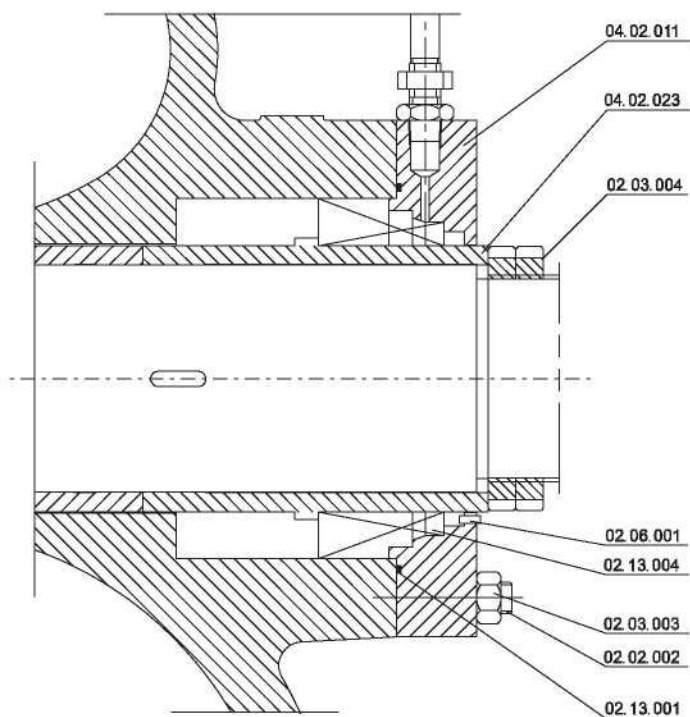

№ Детали	Наименование
04.02.011	Крышка втулки
04.02.023	Защитная втулка вала
02.03.004	Круглая шлицевая гайка
02.06.001	Круглый штифт
02.13.004	Элемент уплотнения вала
02.03.003	Гайка
02.02.002	Болт
02.13.001	Уплотнительное кольцо круглого сечения

Тип А—Применяется в горизонтальных установках тип А и В

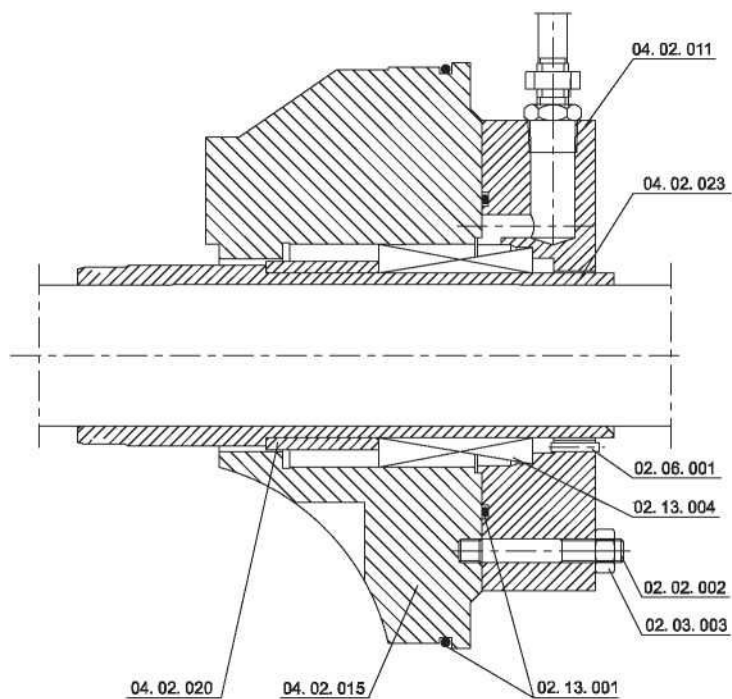

№ Детали	Наименование
04.02.011	Крышка втулки
04.02.023	Защитная втулка вала
02.06.001	Круглый штифт
02.13.004	Элемент уплотнения вала
02.02.002	Болт
02.03.003	Гайка
02.13.001	Уплотнительное кольцо круглого сечения
04.02.015	Корпус втулки вала
04.02.020	Распорная втулка

Тип В—Применяется в горизонтальных установках тип С

Рабочее колесо — Вид в разрезе

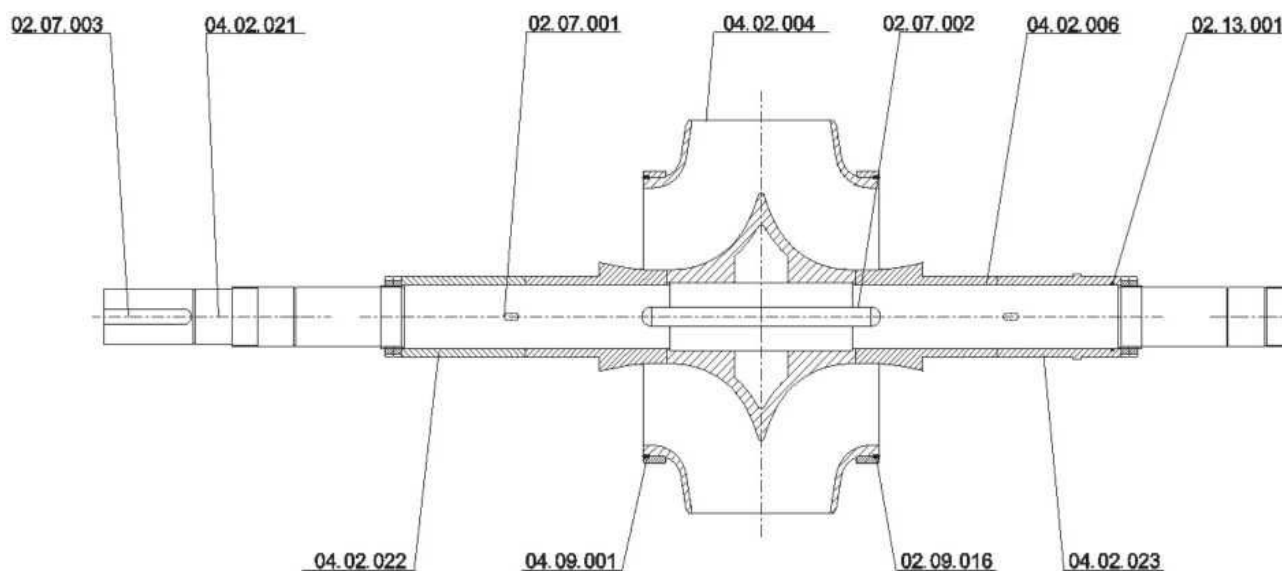

Тип А—Применяется в горизонтальных установках тип А

№ Детали	Наименование	№ Детали	Наименование	№ Детали	Наименование
02.07.003	Шпонка С	04.02.021	Вал	02.07.001	Шпонка А
04.02.004	Рабочее колесо	02.07.002	Шпонка В	04.02.006	Защитная втулка вала
02.13.001	Уплотнительное кольцо круглого сечения	04.02.022	Защитная втулка вала (GP)	04.09.001	Уплотнительное кольцо вала
02.09.016	Центрирующий винт рабочего колеса	04.02.023	Уплотнительное кольцо вала (MS)		

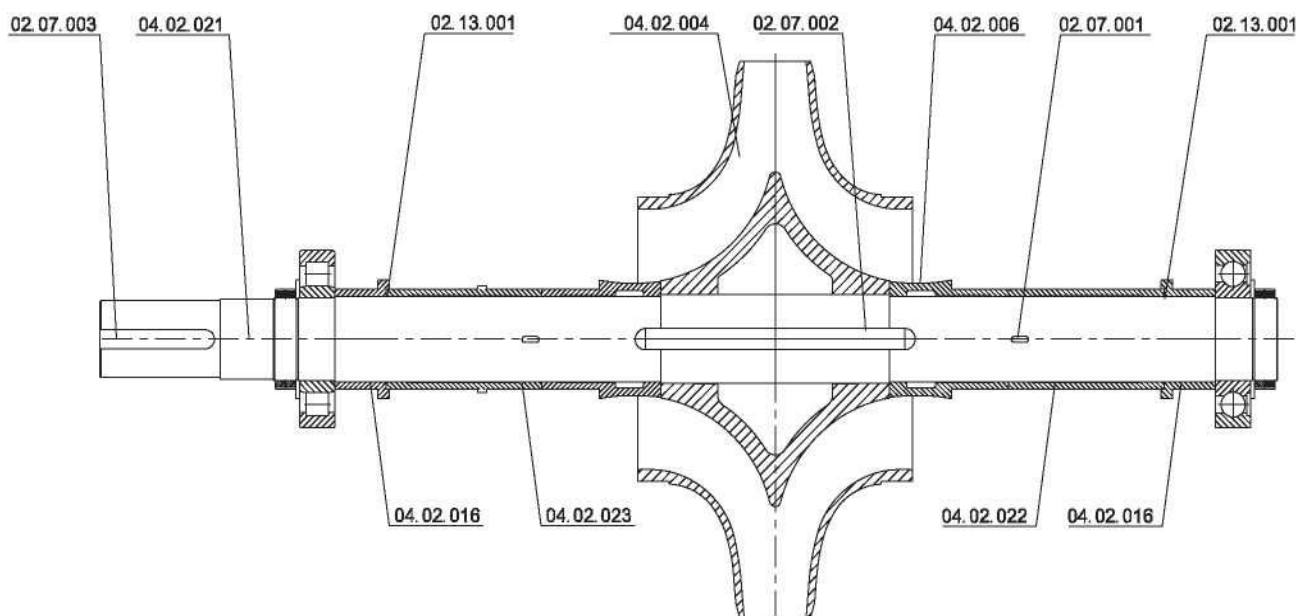

Тип В—Применяется в горизонтальных установках тип В

№ Детали	Наименование	№ Детали	Наименование	№ Детали	Наименование
02.07.003	Шпонка С	04.02.021	Вал	02.13.001	Уплотнительное кольцо круглого сечения
04.02.004	Рабочее колесо	02.07.002	Шпонка В	04.02.006	Защитная втулка вала
02.07.001	Шпонка А	02.07.002	Водозащитная втулка	04.02.023	Защитная втулка вала (MS)
04.02.022	Защитная втулка вала (GP)				

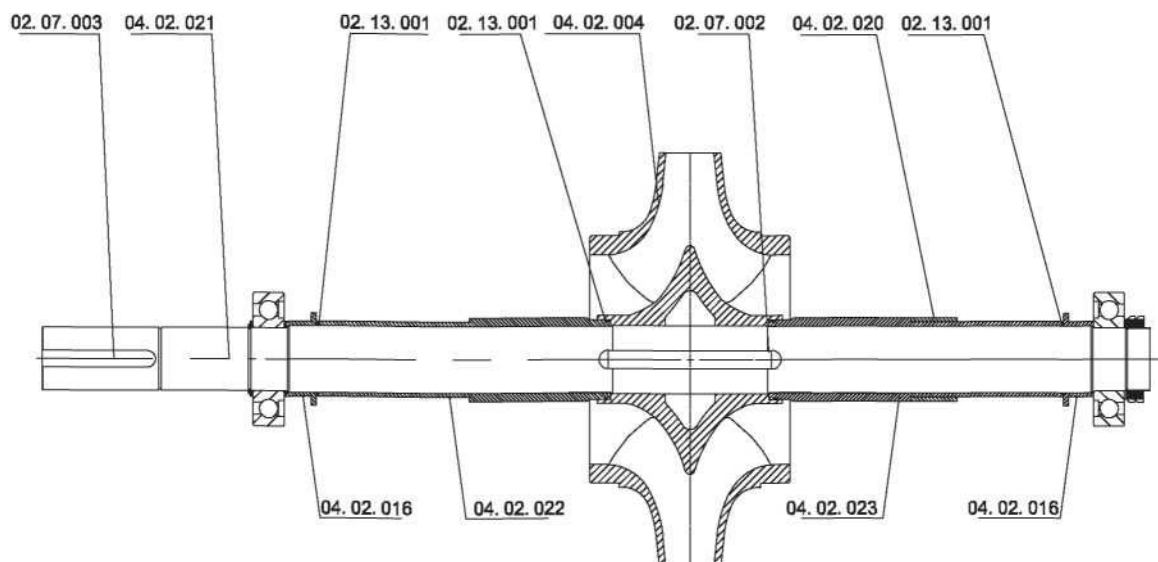

Тип С—Применяется в горизонтальных установках тип С

№ Детали	Наименование	№ Детали	Наименование	№ Детали	Наименование
02.07.003	Шпонка С	04.02.021	Вал	02.13.001	Уплотнительное кольцо круглого сечения
04.02.004	Рабочее колесо	02.07.002	Шпонка В	04.02.020	Распорная втулка(MS)
04.02.023	Защитная втулка вала (MS)	04.02.016	Водозащитная втулка	04.02.022	Защитная втулка вала(GP)

Подшипник — Вид в разрезе

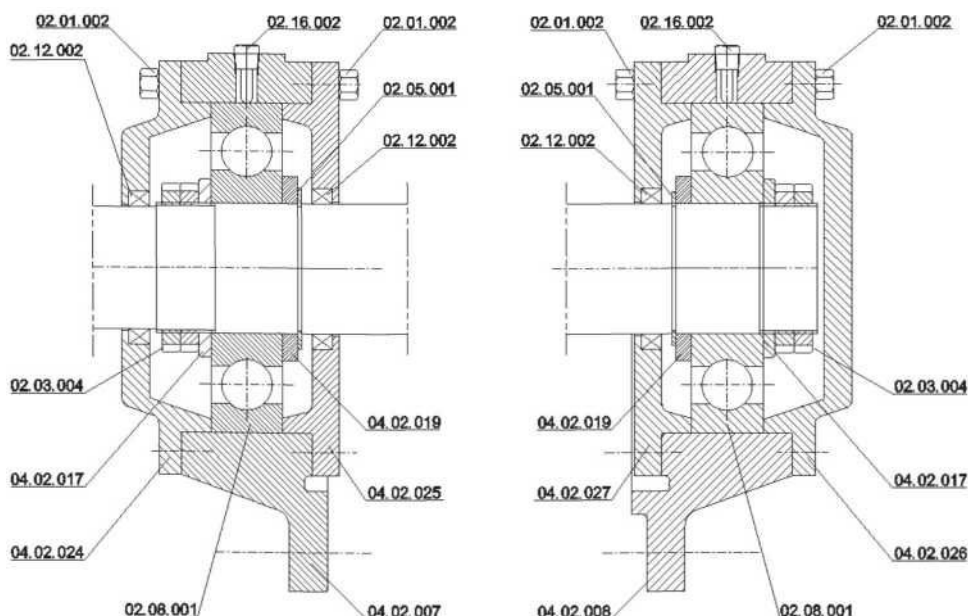

Туре А—Применяется в горизонтальных установках тип А

№ Детали	Наименование	№ Детали	Наименование	№ Детали	Наименование	№ Детали.	Наименование
02.01.002	Шестигранный болт	02.12.002	Стопорное кольцо подшипника	02.03.004	Круглая шлицевая гайка	04.02.017	Пружинный стопор подшипника
04.02.024	Внешний кожух подшипника (OE)	02.08.001	Шариковый подшипник с глубокими ручьями	02.16.002	Пробка	02.05.001	Пружинный стопор вала
04.02.019	Уплотнительное кольцо с кромкой	04.02.025	Внутренний кожух подшипника (DE)	04.02.007	Корпус подшипника (DE)	04.02.027	Внутренний кожух вала (NDE)
04.02.008	Корпус подшипника (NDE)	04.02.026	Наружный кожух вала (NDE)				

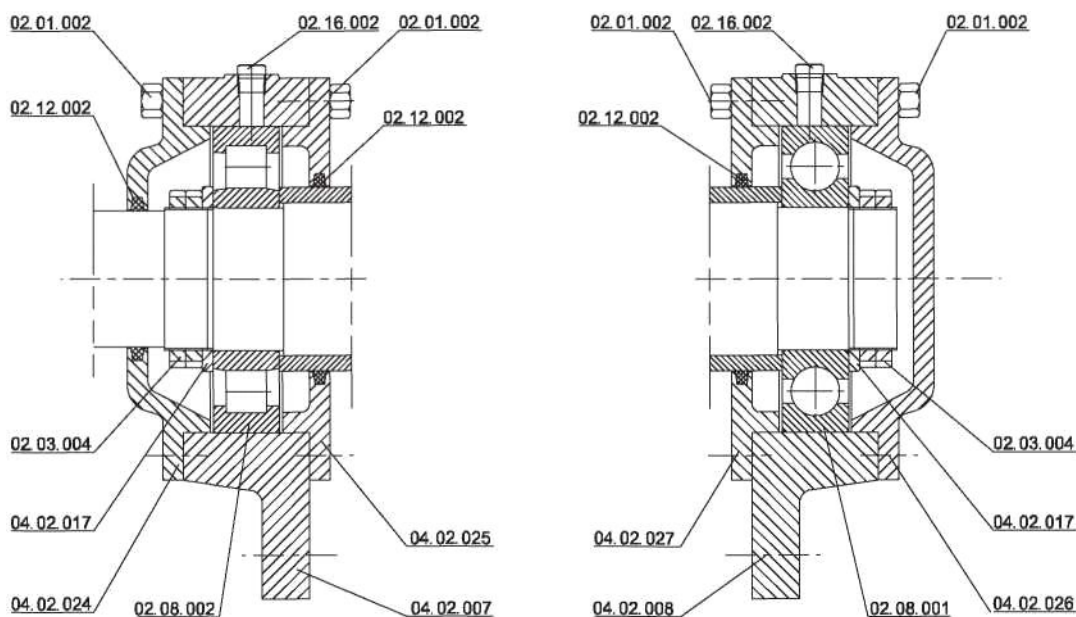

Туре В—Применяется в горизонтальных установках тип В

№ Детали	Наименование	№ Детали	Наименование	№ Детали	Наименование	№ Детали	Наименование
02.01.002	Шестигранный болт	02.12.002	Войлочное кольцо	02.03.004	Круглая шлицевая гайка	04.02.017	Пружинный стопор подшипника
04.02.024	Внешний кожух подшипника (DE)	02.08.002	Роликовый подшипник	02.16.002	Пробка	04.02.025	Внутренний кожух подшипника (DE)
04.02.007	Корпус подшипника (OE)	04.02.027	Внутренний кожух подшипника (NDE)	04.02.008	Корпус подшипника (NDE)	02.08.001	Шариковый подшипник с глубокими ручьями
04.02.026	Внешний кожух подшипника (NDE)						

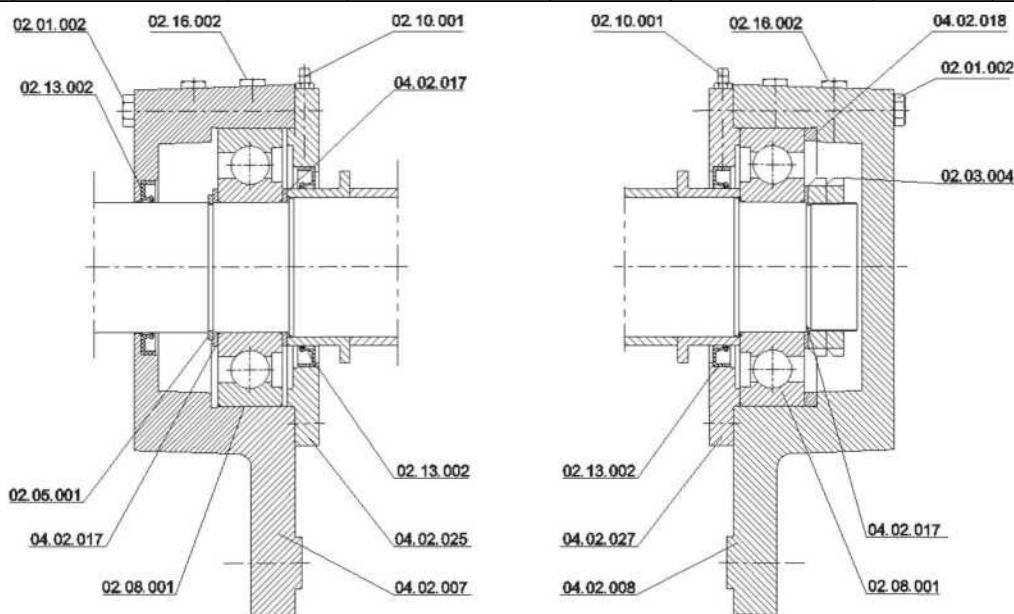

Туре С—Применяется в горизонтальных установках тип С

№ Детали	Наименование	№ Детали	Наименование	№ Детали	Наименование	№ Детали	Наименование
02.01.002	Шестигранный болт	02.13.002	Уплотнительное кольцо с кромкой	02.05.001	Пружинный стопор вала	04.02.017	Пружинный стопор подшипника
02.08.001	Шариковый подшипник с глубокими ручьями	02.16.002	Пробка	02.10.001	Сквозная маслѐнка	04.02.025	Внутренний кожух подшипника (DE)
04.02.007	Корпус подшипника (DE)	04.02.027	Внутренний кожух подшипника (NDE)	04.02.008	Корпус подшипника (NDE)	04.02.018	Установочное кольцо подшипника
02.03.004	Круглая шлицевая гайка						

Подшипник с масляной смазкой

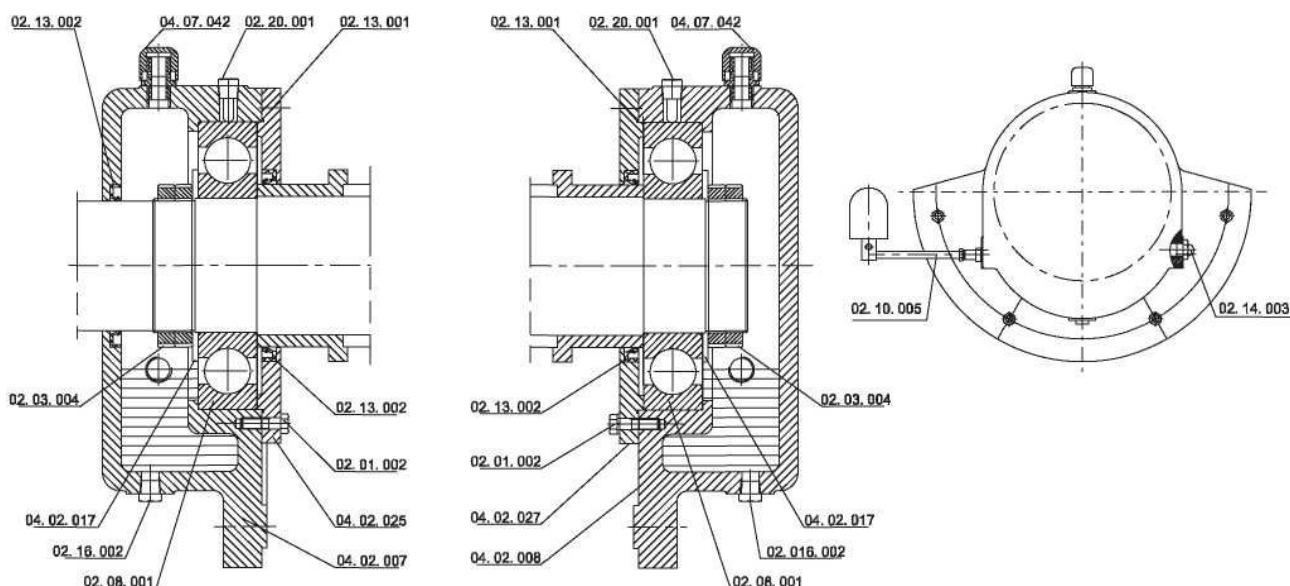

№ Детали.	Наименование	№ Детали	Наименование	№ Детали	Наименование	№ Детали	Наименование
02.13.002	Уплотнительное кольцо с кромкой	02.03.004	Круглая шлицевая гайка	04.02.017	Пружинный стопор подшипника	02.16.002	Пробка
02.08.001	Шариковый подшипник с глубокими пазами	04.07.042	Крышка сопуна	02.20.001	Устройство измерения температуры	02.13.001	Уплотнительное кольцо круглого сечения
02.01.002	Шестигранный болт	04.02.025	Внутренний кожух подшипника (DE)	04.02.007	Корпус подшипника (DE)	04.02.027	Внутренний кожух подшипника (NDE)
04.02.008	Корпус подшипника (NDE)	02.14.003	Визуальный масляный уровень	02.10.005	Маслёнка постоянного уровня		

Подшипник с водяным охлаждением (Для высокотемпературных жидкостей)

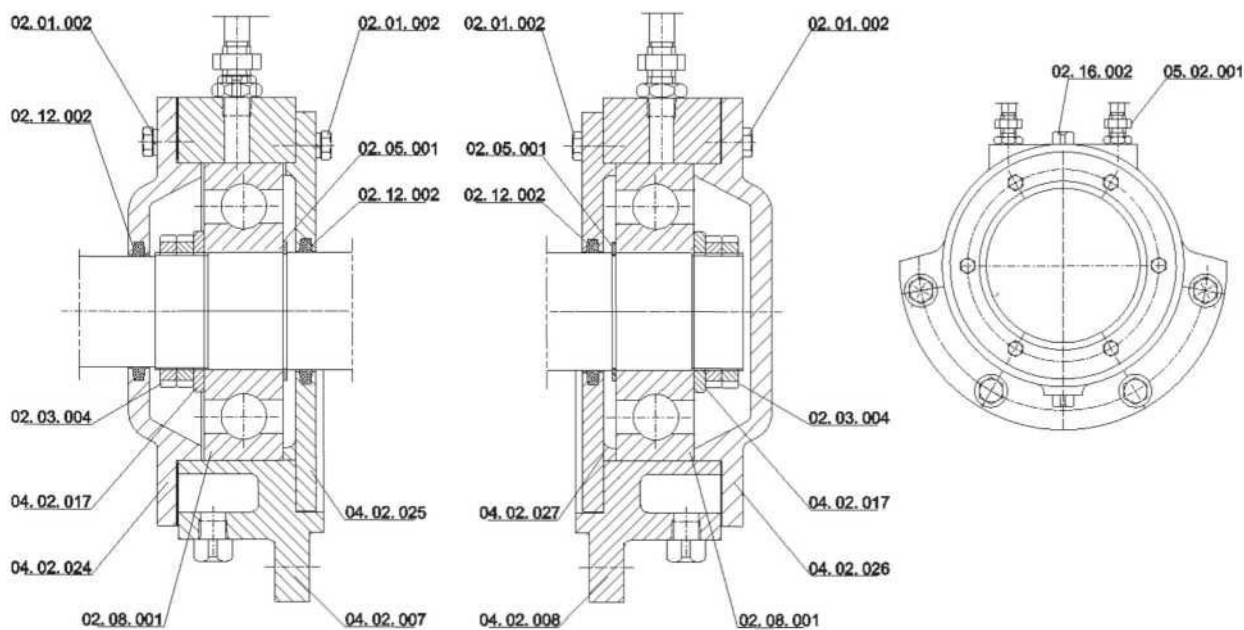

№ Детали	Наименование	№ Детали	Наименование	№ Детали	Наименование	№ Детали	Наименование
02.01.002	Шестигранный болт	02.12.002	Войлочное кольцо	02.03.004	Круглая шлицевая гайка	04.02.017	Пружинный стопор подшипника
04.02.024	Внешний кожух подшипника (DE)	02.08.001	Шариковый подшипник с глубокими пазами	02.05.001	Пружинный стопор вала	04.02.008	Корпус подшипника (NDE)
04.02.025	Внутренний кожух подшипника (DE)	04.02.007	Корпус подшипника (DE)	04.02.027	Внутренний кожух подшипника (NDE)		
04.02.026	Внешний кожух подшипника (NDE)	02.16.002	Пробка	05.02.001	Трубопровод охлаждения		

Диапазон производительности

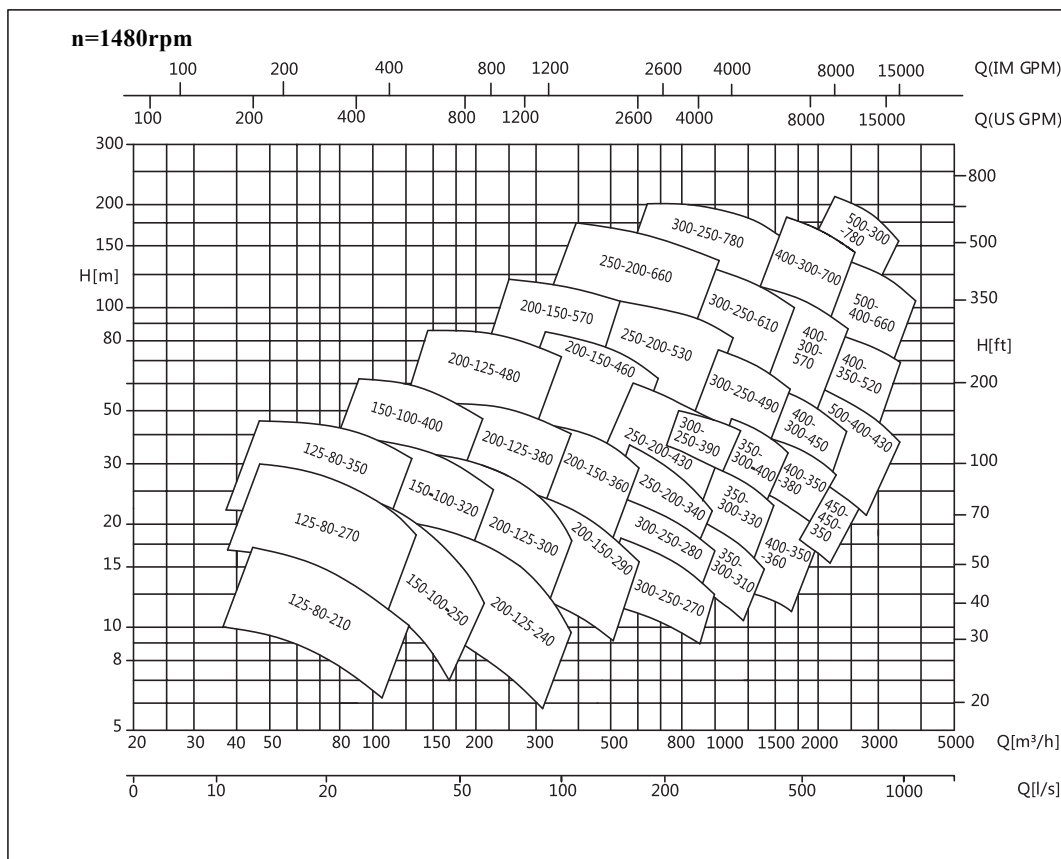
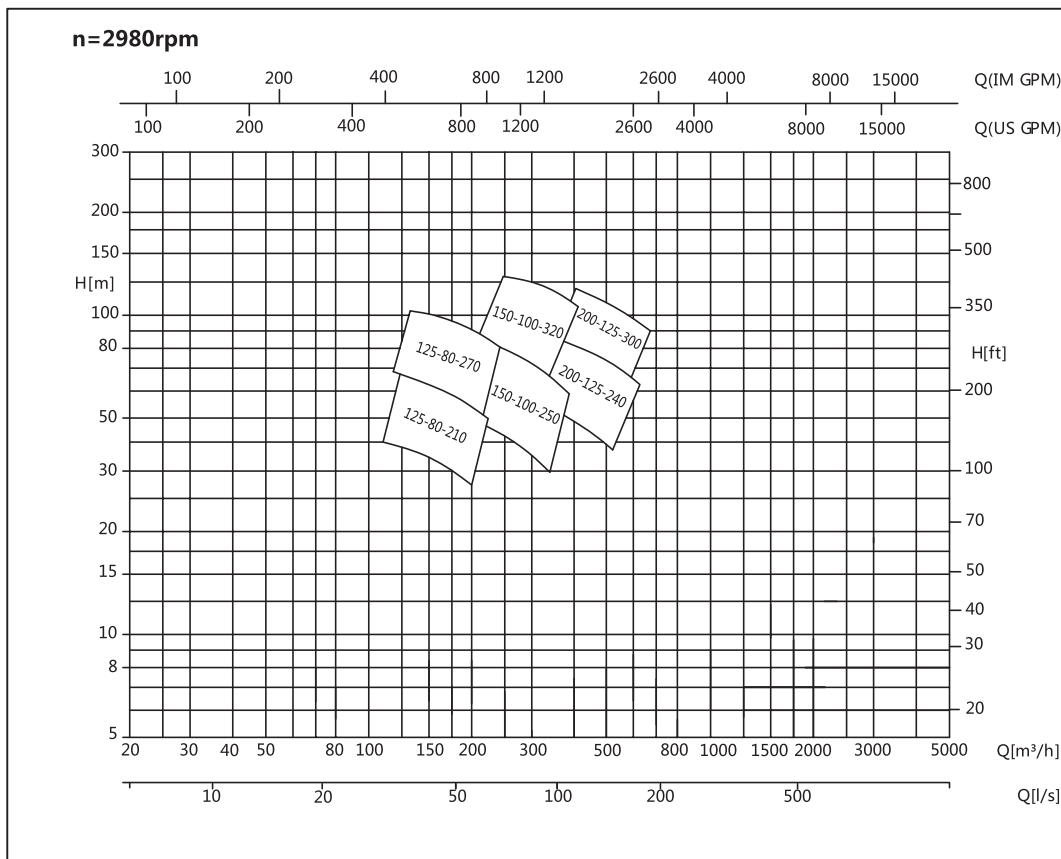

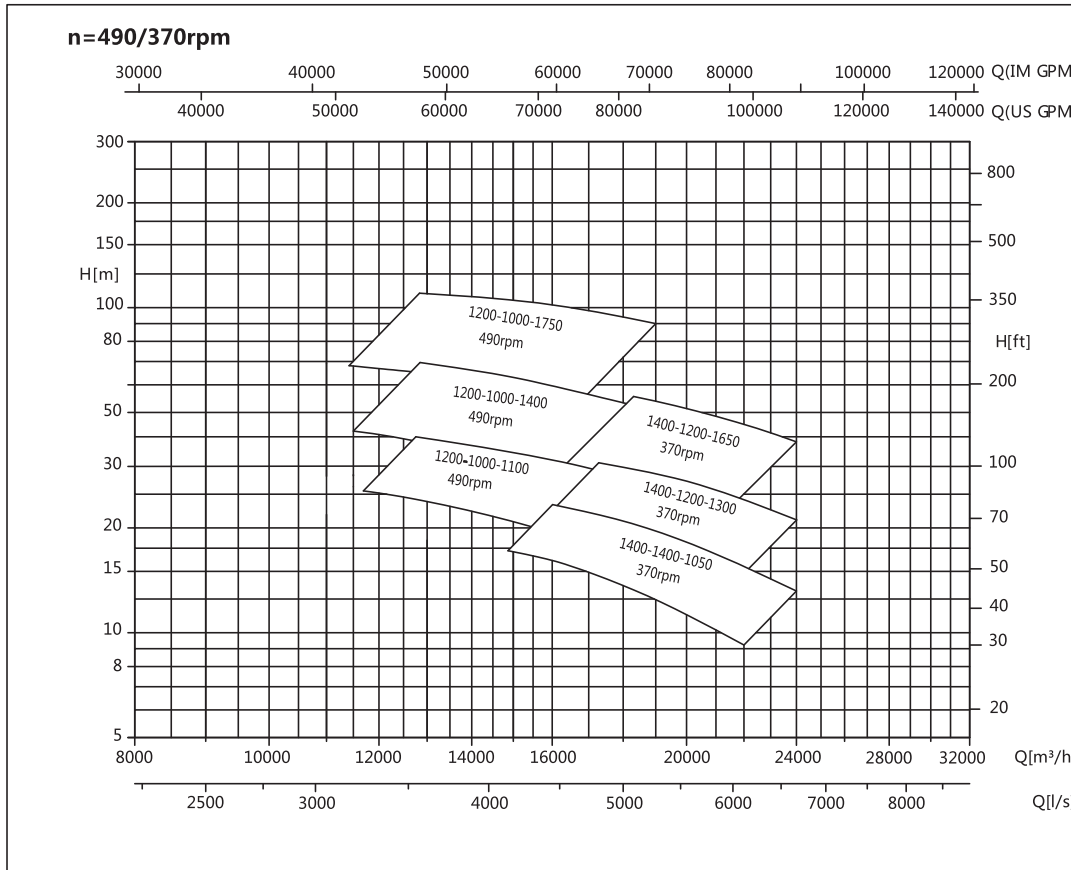
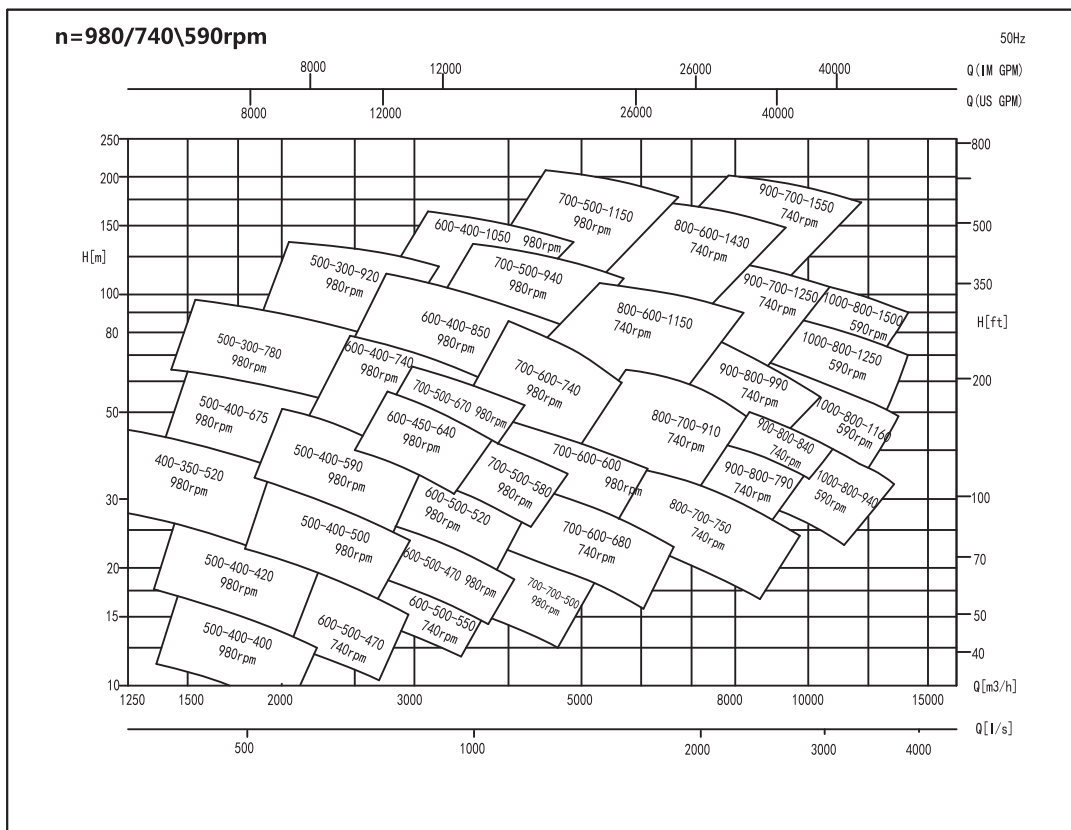

Кривые производительности

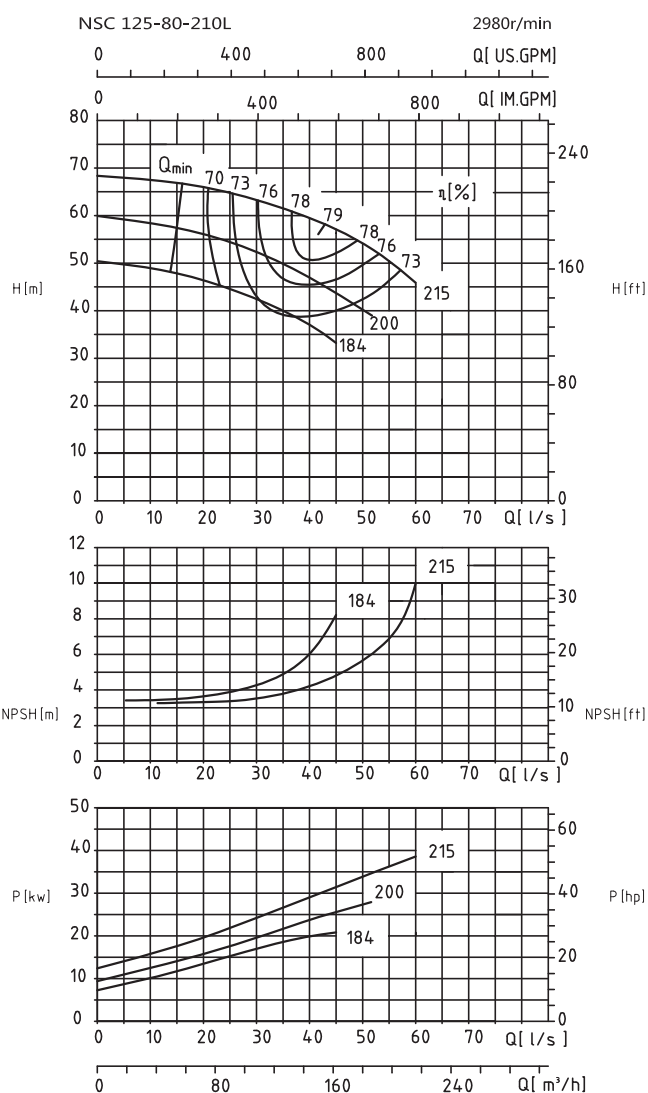
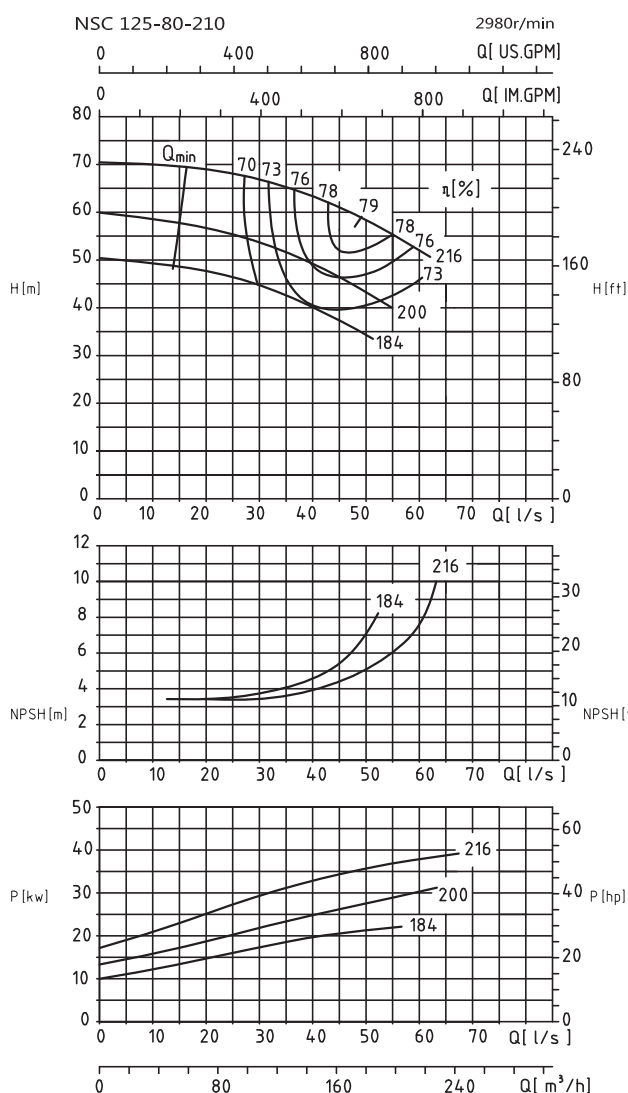

Модель	Производительность		Напор (m)	Скорость (r/min)	Мощность (kw)	Мощность на валу (kw)	КПД (%)	NPSHr (m)	Масса (kg)
	(m³/h)	(L/s)							
NSC125-80-210	140	38.9	64	2980	45	32.1	76	4.0	180
	175	48.6	59			35.6	79	5.0	
	200	55.6	55			38.4	78	6.0	
NSC125-80-210A	120	33.3	52		37	23.3	73	3.7	
	150	41.7	47.8			25.7	76	4.5	
	180	50.0	43			28.1	75	6.0	
NSC125-80-210B	115	31.9	44.5		30	19.6	71	3.7	
	145	40.3	39			21.1	73	4.5	
	175	48.6	35			23.5	71	7.0	
NSC125-80-210L	120	33.3	62	45	26.3	77	3.7		
	150	41.7	58.3		30.2	79	4.4		
	180	50.0	54.2		34.5	77	5.6		
NSC125-80-210LA	110	30.6	52	37	20.8	75	3.9		
	140	38.9	47.5		23.5	77	4.9		
	170	47.2	42		26.3	74	7.0		
NSC125-80-210LB	100	27.8	43.2	30	16.4	72	4.0		
	130	36.1	39.2		19.0	73	5.0		
	160	44.4	33.7		21.0	70	8.0		

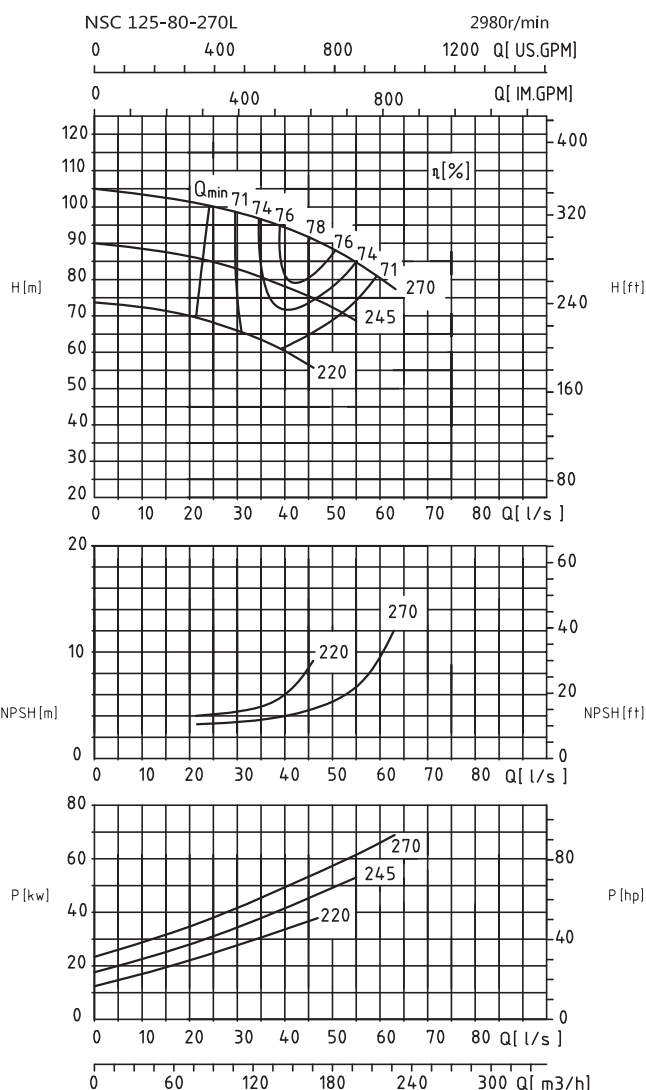
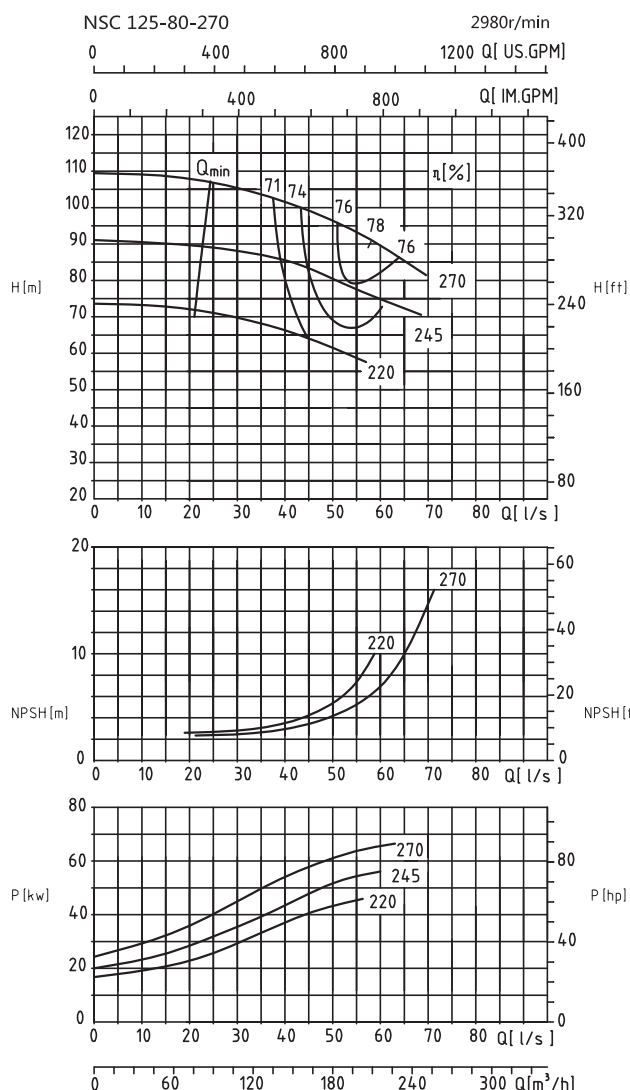

Модель	Производительность		Напор (m)	Скорость (r/min)	Мощность (kw)	Мощность на валу (kw)	КПД (%)	NPSHr (m)	Масса (kg)
	(m³/h)	(L/s)							
NSC125-80-270	165	45.8	98.4	2980	90	59.8	74	3.7	185
	195	54.2	93.5			63.7	78	5.2	
	225	62.5	87.5			71.5	75	8.0	
NSC125-80-270A	150	41.7	84.9		75	48.2	72	3.8	
	180	50.0	80.2			51.1	77	5.0	
	210	58.3	75.6			59.3	73	8.1	
NSC125-80-270B	135	37.5	67		55	35.7	69	3.7	
	165	45.8	63.5			40.2	71	4.3	
	195	54.2	59			43.5	72	7.3	
NSC125-80-270L	135	37.5	95.5	2980	90	47.5	74	3.9	185
	165	45.8	91			52.5	78	4.3	
	195	54.2	85			61.0	74	6.2	
NSC125-80-270LA	120	33.3	81.5		75	36.5	73	4.0	
	150	41.7	77.5			42.2	75	5.0	
	180	50.0	72.5			49.4	72	7.0	
NSC125-80-270LB	110	30.6	65.5		55	27.7	71	4.2	
	135	37.5	62			31.7	72	5.2	
	165	45.8	56			36.5	69	8.8	

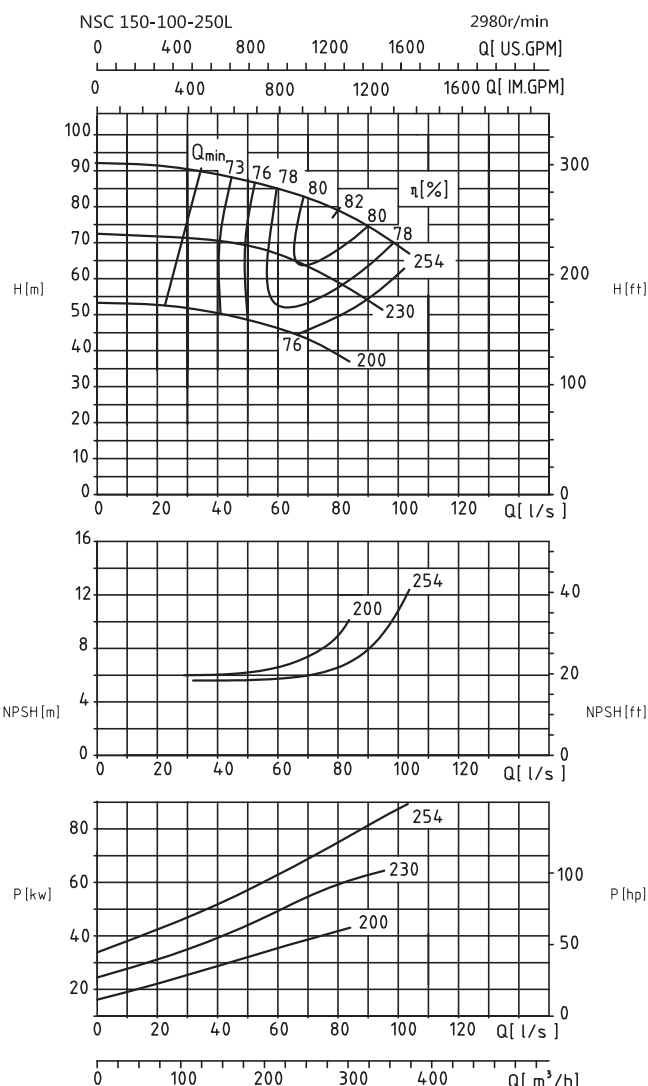
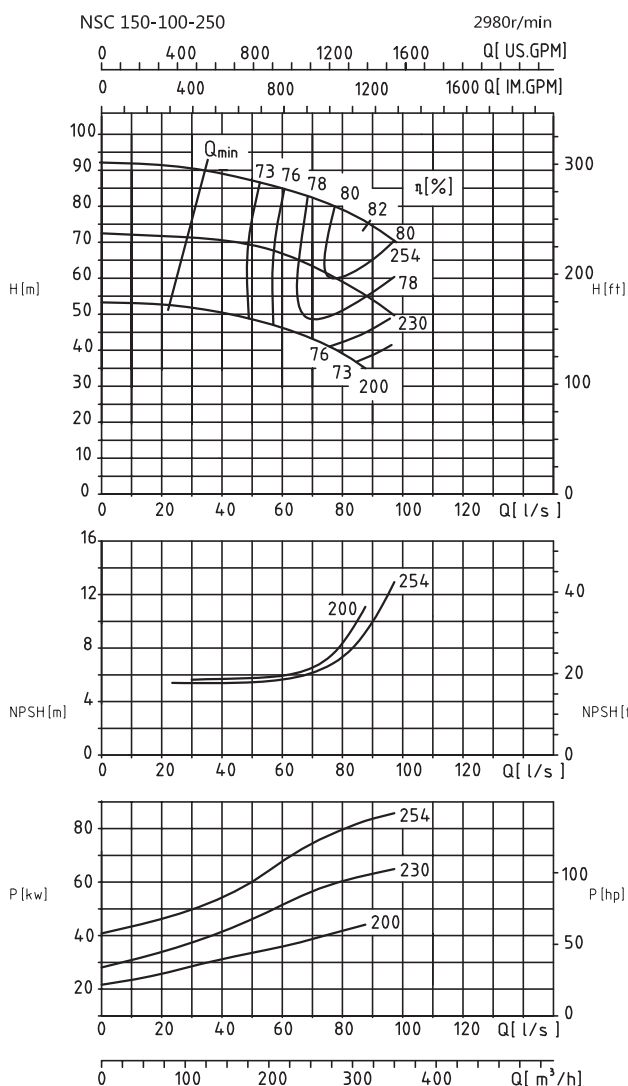

Модель	Производительность		Напор (м)	Скорость (r/min)	Мощность (kw)	Мощность на валу (kw)	КПД (%)	NPSHr (м)	Масса (kg)
	(m³/h)	(L/s)							
NSC150-100-250	200	55.6	85.3	2980	90	62.8	74	5.7	220
	275	76.4	80			74.9	80	6.8	
	320	88.9	75			79.8	82	9.6	
NSC150-100-250A	200	55.6	68		75	49.4	75	5.8	
	270	75.0	61			56.1	80	6.9	
	320	88.9	54			62.0	76	10.0	
NSC150-100-250B	175	48.6	49		55	32.0	73	5.9	
	250	69.4	43			38.0	77	6.3	
	300	83.3	37			41.4	73	9.0	
NSC150-100-250L	200	55.6	86	110	60.9	77	5.8	220	
	275	76.4	80		73.1	82	6.2		
	325	90.3	75		83.0	80	8.0		
NSC150-100-250LA	200	55.6	68	75	49.4	75	6.0		
	250	69.4	63.5		54.1	80	6.8		
	300	83.3	57.5		61.9	76	9.0		
NSC150-100-250LB	175	48.6	49	55	31.2	75	6.1		
	225	62.5	45.2		36.5	76	6.8		
	275	76.4	40.2		40.7	74	8.1		

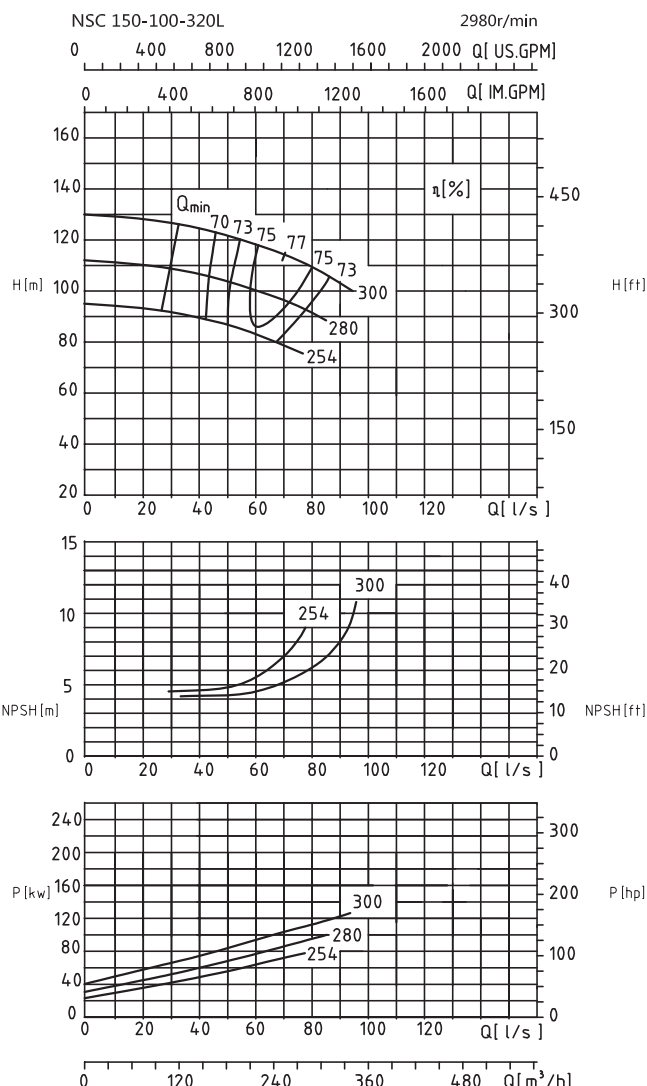
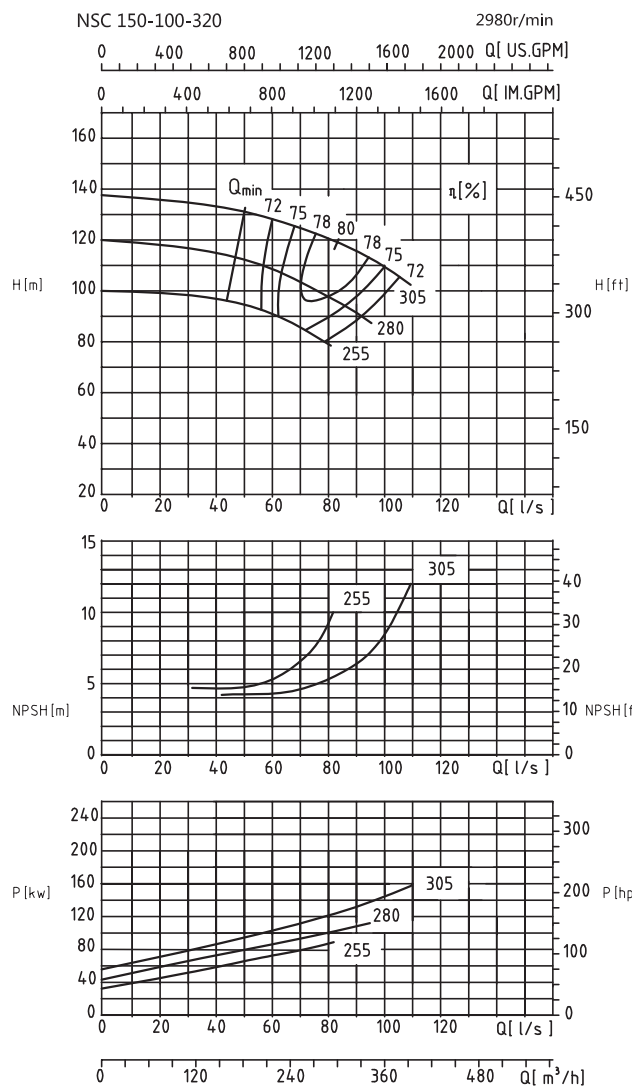

Модель	Производительность		Напор (м)	Скорость (r/min)	Мощность (kw)	Мощность на валу (kw)	КПД (%)	NPSHr (м)	Масса (kg)
	(m³/h)	(L/s)							
NSC150-100-320A	270	75.0	122.5	2980	160	115.6	78	4.9	230
	300	83.3	119			121.6	80	5.7	
	330	91.7	115			132.6	78	6.7	
NSC150-100-320B	240	66.7	105		132	90.4	76	5.5	
	270	75.0	100.5			93.6	79	6.5	
	300	83.3	95.5			102.7	76	8.0	
NSC150-100-320C	210	58.3	91		110	72.3	72	5.1	
	240	66.7	88			75.7	76	6.0	
	270	75.0	82			83.8	72	8.5	
NSC150-100-320LA	180	50.0	121.5	132	83.9	71	4.4		
	240	66.7	116		99.8	76	5.1		
	300	83.3	107.5		118.8	74	7.0		
NSC150-100-320LB	180	50.0	104	110	70.9	72	4.5		
	225	62.5	100		80.7	76	5.3		
	270	75.0	94		93.5	74	7.0		
NSC150-100-320LC	165	45.8	88	90	55.0	72	4.8		
	210	58.3	84		63.2	76	5.3		
	255	70.8	78.5		75.8	72	7.0		

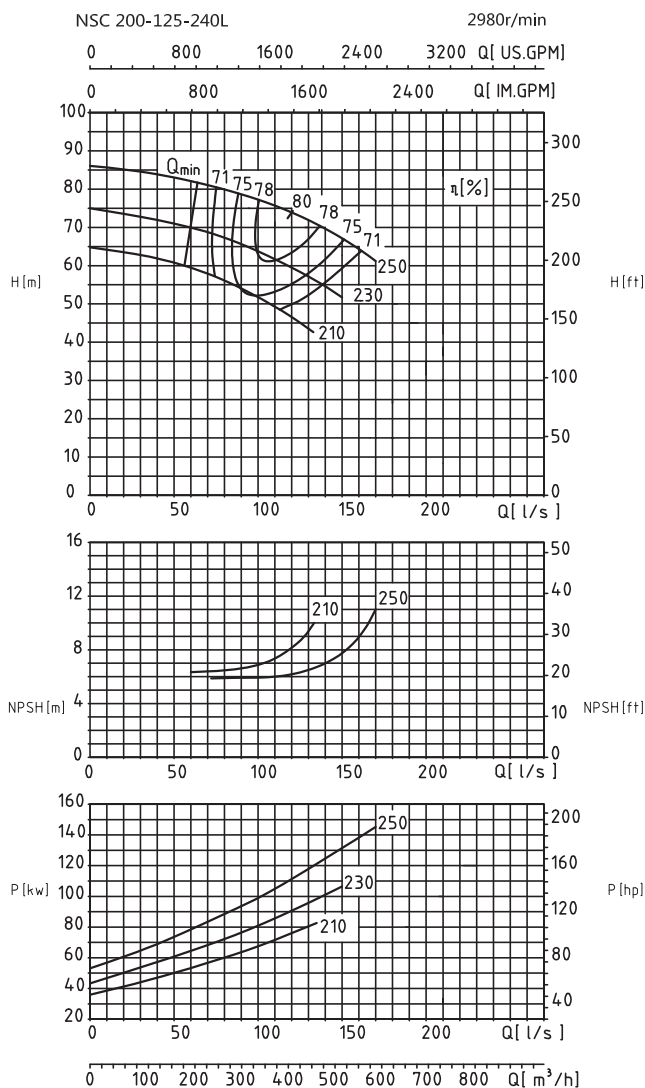
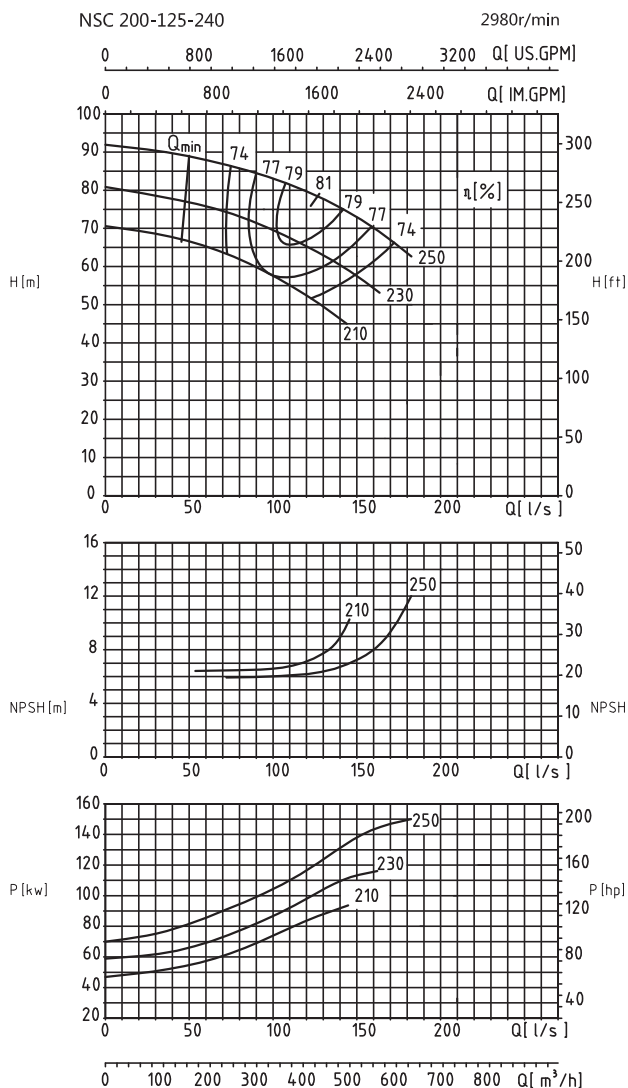

Модель	Производительность		Напор (m)	Скорость (r/min)	Мощность (kw)	Мощность на валу (kw)	КПД (%)	NPSH _r (m)	Масса (kg)
	(m³/h)	(L/s)							
NSC200-125-240	350	97.2	83.5	2980	160	103.4	77	6.0	295
	450	125.0	78.7			119.1	81	6.4	
	550	152.8	72			140.1	77	7.4	
NSC200-125-240A	325	90.3	71.5		132	82.2	77	6.2	
	425	118.1	65.8			96.5	79	6.5	
	525	145.8	58.8			112.2	75	8.6	
NSC200-125-240B	300	83.3	61		110	66.5	75	6.5	
	375	104.2	56.5			76.0	76	6.6	
	450	125.0	51			85.7	73	7.4	
NSC200-125-240L	325	90.3	78.5	160	92.7	75	6.0	295	
	425	118.1	74.2		107.4	80	6.2		
	525	145.8	68		128.0	76	7.5		
NSC200-125-240LA	300	83.3	67	132	73.0	75	6.2		
	400	111.1	61.3		85.7	78	6.8		
	500	138.9	55		105.5	71	8.8		
NSC200-125-240LB	275	76.4	57	110	60.2	71	6.5		
	350	97.2	52.5		66.8	75	6.9		
	425	118.1	47.2		78.1	70	8.0		

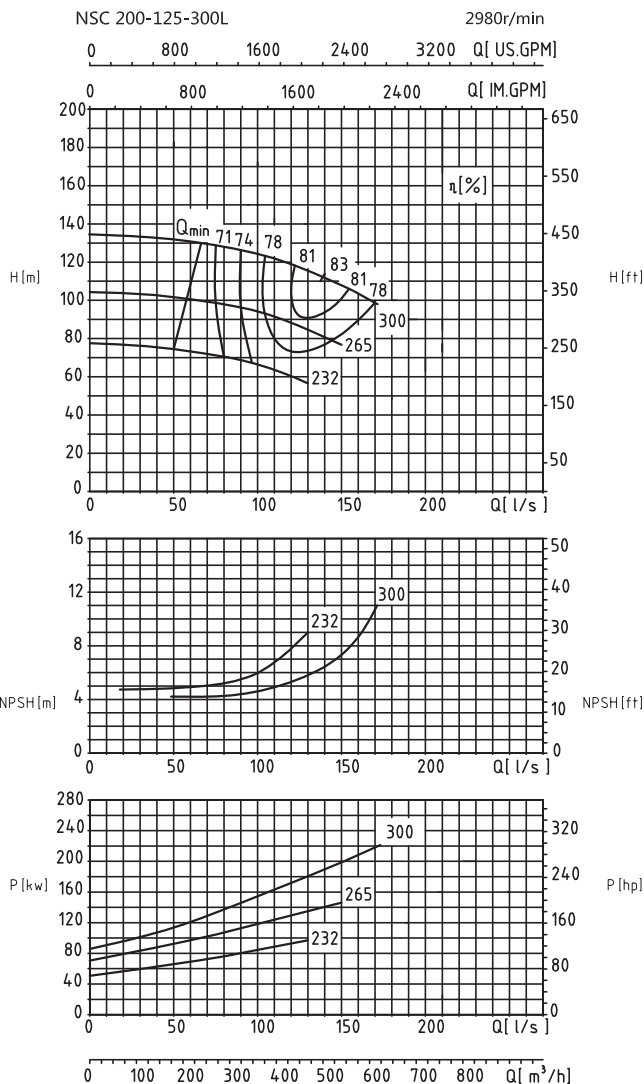
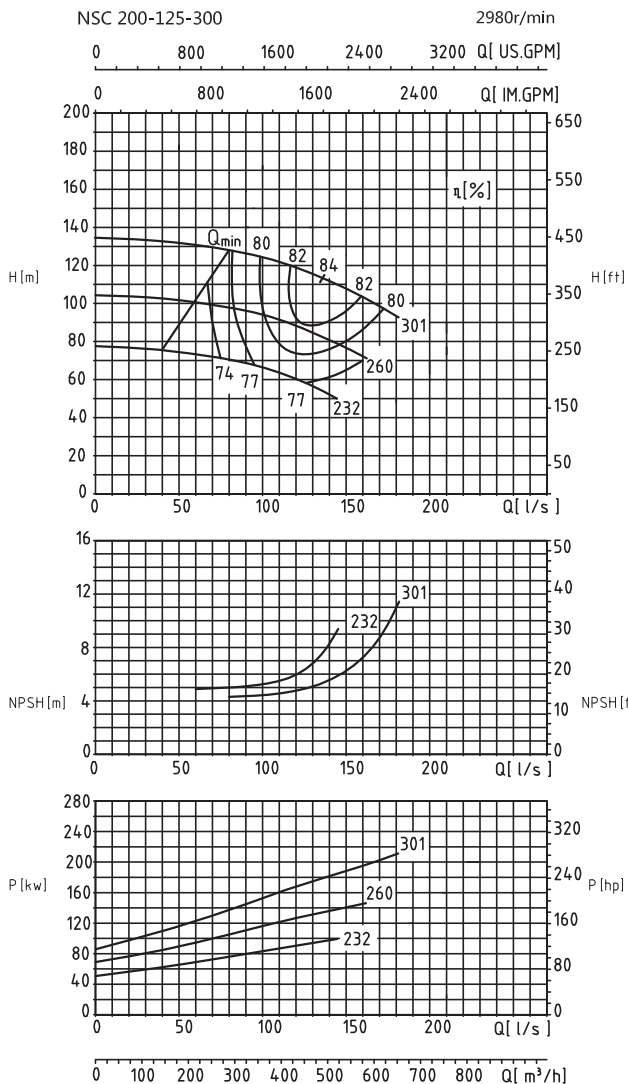

Модель	Производительность		Напор (m)	Скорость (r/min)	Мощность (kw)	Мощность на валу (kw)	КПД (%)	NPSHr (m)	Масса (kg)
	(m³/h)	(L/s)							
NSC200-125-300	400	111.1	121	2980	220	162.8	81	4.5	315
	500	138.9	112			181.7	84	5.3	
	600	166.7	100			201.9	81	8.0	
NSC200-125-300A	350	97.2	95		160	114.7	79	4.7	
	450	125.0	87			131.7	81	5.5	
	550	152.8	75			142.3	79	8.6	
NSC200-125-300B	325	90.3	69		132	80.4	76	5.0	
	400	111.1	63			88.0	78	5.6	
	475	131.9	56			96.6	75	7.0	
NSC200-125-300L	375	104.2	122	250	159.8	78	4.8	315	
	475	131.9	115		181.5	82	6.0		
	575	159.7	103.5		205.3	79	8.7		
NSC200-125-300LA	325	90.3	96	160	107.6	79	5.0		
	425	118.1	89.5		128.0	81	6.1		
	525	145.8	79		143.1	79	8.5		
NSC200-125-300LB	300	83.3	70	132	79.5	72	5.2		
	375	104.2	66		89.9	75	6.3		
	450	125.0	59		97.8	74	8.4		

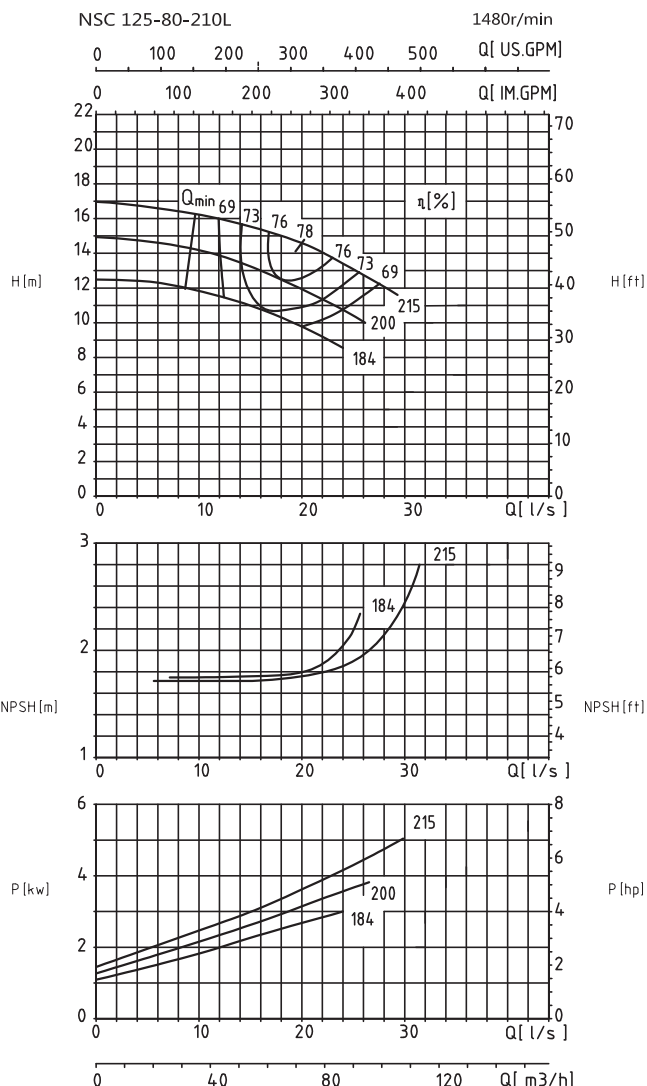
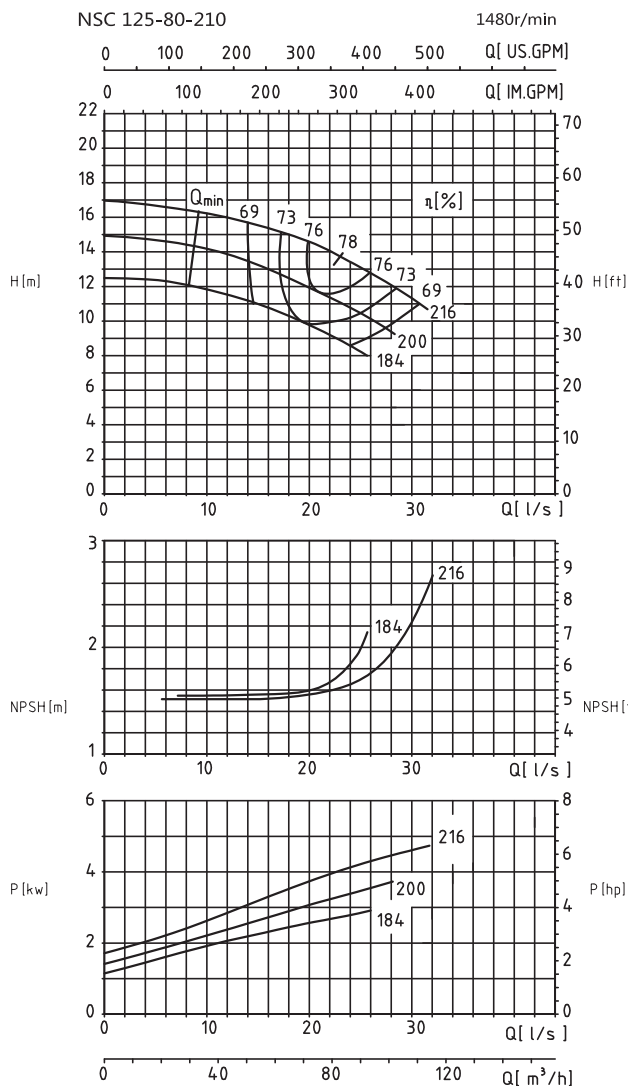

Модель	Производительность		Напор (м)	Скорость (r/min)	Мощность (kw)	Мощность на валу (kw)	КПД (%)	NPSHг (м)	Масса (kg)
	(m³/h)	(L/s)							
NSC125-80-210	67	18.6	15	1480	7.5	3.7	75	1.5	180
	83	23.1	13.8			4.0	78	1.6	
	100	27.8	12			4.4	75	1.9	
NSC125-80-210A	60	16.7	12.9		5.5	2.9	72	1.5	
	75	20.8	11.8			3.2	76	1.7	
	90	25.0	10.5			3.5	73	1.9	
NSC125-80-210B	55	15.3	11		4	2.4	69	1.5	
	72	20.0	9.8			2.6	73	1.6	
	86	23.9	8.7			3.0	69	1.8	
NSC125-80-210L	50	13.9	15.7	7.5	3.0	72	1.7	180	
	70	19.4	14.7		3.6	78	1.8		
	90	25.0	13		4.4	73	1.9		
NSC125-80-210LA	50	13.9	13.5	5.5	2.6	72	1.7		
	65	18.1	12.5		2.9	76	1.7		
	80	22.2	11.3		3.4	73	1.8		
NSC125-80-210LB	50	13.9	11.2	4	2.1	71	1.8		
	60	16.7	10.7		2.4	73	1.8		
	70	19.4	10		2.7	70	1.8		

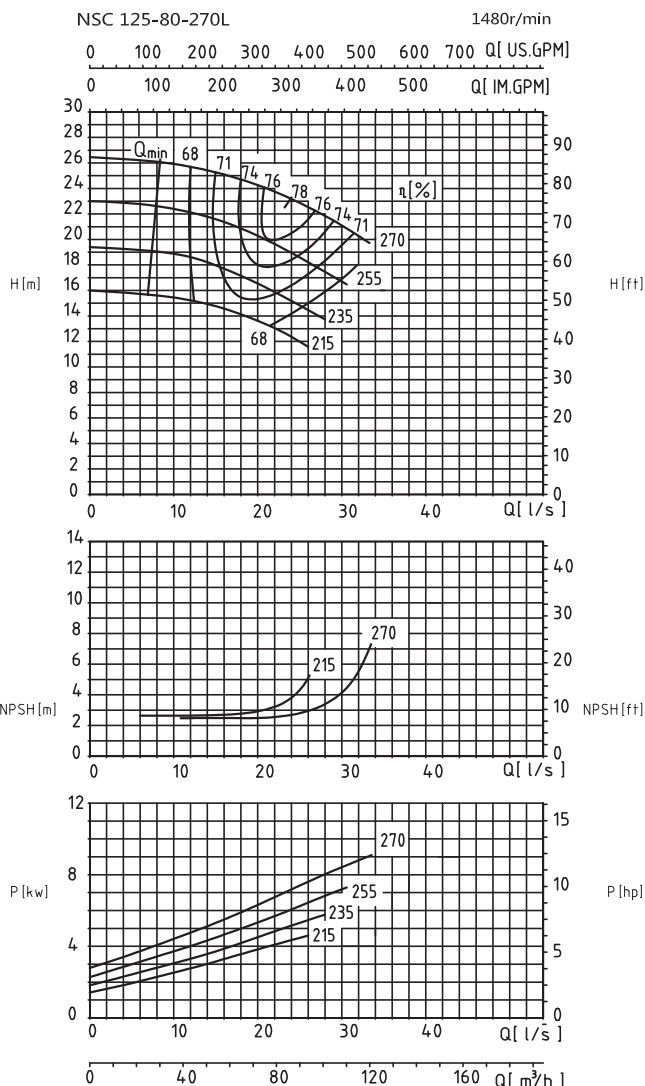
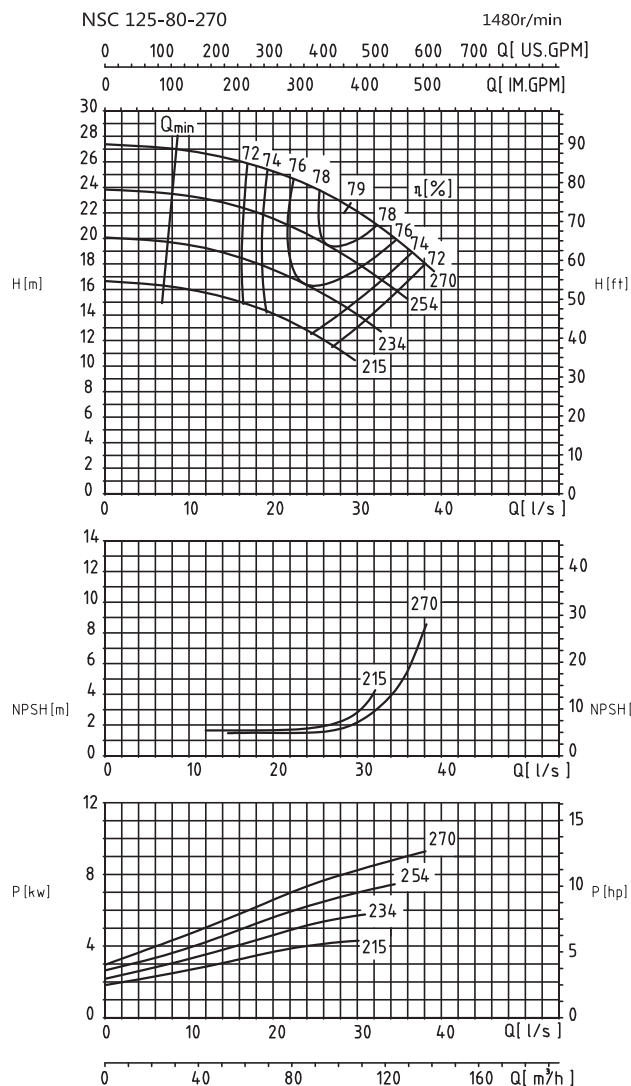

Модель	Производительность		Напор (м)	Скорость (r/min)	Мощность (kw)	Мощность на валу (kw)	КПД (%)	NPSHг (м)	Масса (kg)
	(m³/h)	(L/s)							
NSC125-80-270	70	19.4	25.4	1480	11	6.5	74	1.8	185
	104	28.9	22.5			8.1	79	2.0	
	130	36.1	19			9.1	74	5.5	
NSC125-80-270A	80	22.2	21		11	6.0	76	1.6	
	99	27.5	19			6.7	77	2.0	
	120	33.3	16.5			7.3	74	4.8	
NSC125-80-270B	70	19.4	17.8		7.5	4.6	74	1.7	
	90	25.0	16			5.2	76	1.8	
	110	30.6	13.6			5.7	72	3.3	
NSC125-80-270C	60	16.7	14.9		5.5	3.4	72	1.6	
	84	23.3	13			4.0	75	1.8	
	100	27.8	11.3			4.3	71	2.3	
NSC125-80-270L	60	25.0	25.4	11	5.8	72	2.5	185	
	85	23.3	22.5		6.7	78	2.7		
	110	20.9	19		7.9	72	4.4		
NSC125-80-270LA	50	13.9	21.9	11	4.3	70	2.5		
	75	20.8	20		5.5	75	2.7		
	100	27.8	17.6		6.9	70	4.5		
NSC125-80-270LB	50	13.9	18.2	7.5	3.5	70	2.5		
	70	19.4	16.7		4.4	72	2.7		
	90	25.0	14.8		5.2	70	3.8		
NSC125-80-270LC	45	12.5	15.1	5.5	2.7	68	1.6		
	65	18.1	14.1		2.8	70	1.8		
	80	22.2	13		3.3	67	2.3		

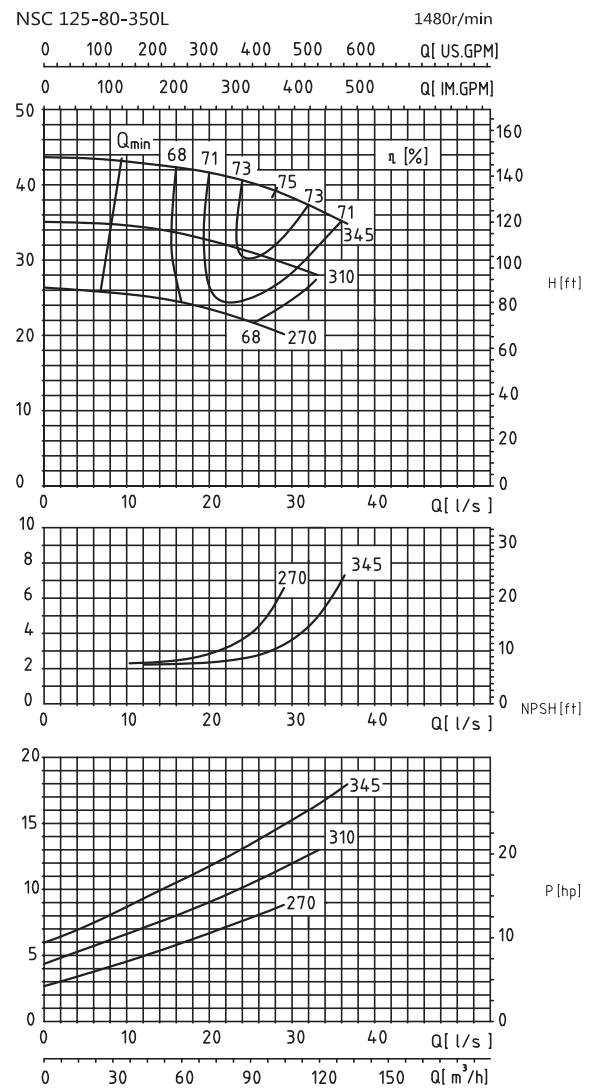
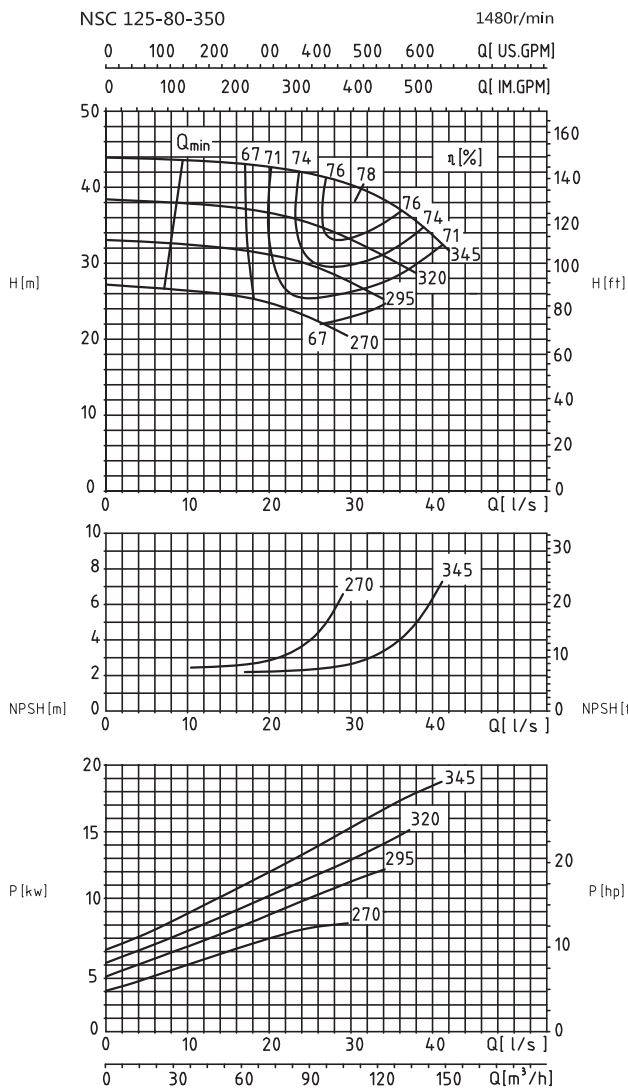

Модель	Производительность		Напор (м)	Скорость (r/min)	Мощность (kw)	Мощность на валу (kw)	КПД (%)	NPSHr (м)	Масса (kg)
	(m ³ /h)	(L/s)							
NSC125-80-350	95	26.4	41.4	1480	22	14.1	76	2.3	210
	115	31.9	39.5			15.9	78	3.0	
	135	37.5	36			17.7	75	4.8	
NSC125-80-350A	85	23.6	35.8		18.5	11.2	74	2.7	
	105	29.2	33.5			12.6	76	3.7	
	125	34.7	30.6			14.3	73	5.7	
NSC125-80-350B	75	20.8	31.1		15	9.0	71	2.7	
	95	26.4	29.2			10.4	73	3.6	
	115	31.9	26.5			11.7	71	5.8	
NSC125-80-350C	70	19.4	24.7	11	6.9	68	2.8		
	90	25.0	21.9		7.9	68	4.0		
	100	27.8	19		7.8	66	5.5		
NSC125-80-350L	82	22.8	41	22	12.7	72	2.5	210	
	105	29.2	38.8		14.8	75	3.4		
	120	33.3	36.6		16.6	72	5.0		
NSC125-80-350LA	70	19.4	32.8	18.5	8.8	71	2.5		
	90	25.0	31		10.4	73	3.5		
	113	31.3	28.8		12.4	71	5.5		
NSC125-80-350LB	60	16.7	24.1	11	5.8	68	2.4		
	75	20.8	23.1		6.7	70	3.0		
	90	25.0	21.9		7.9	68	4.0		

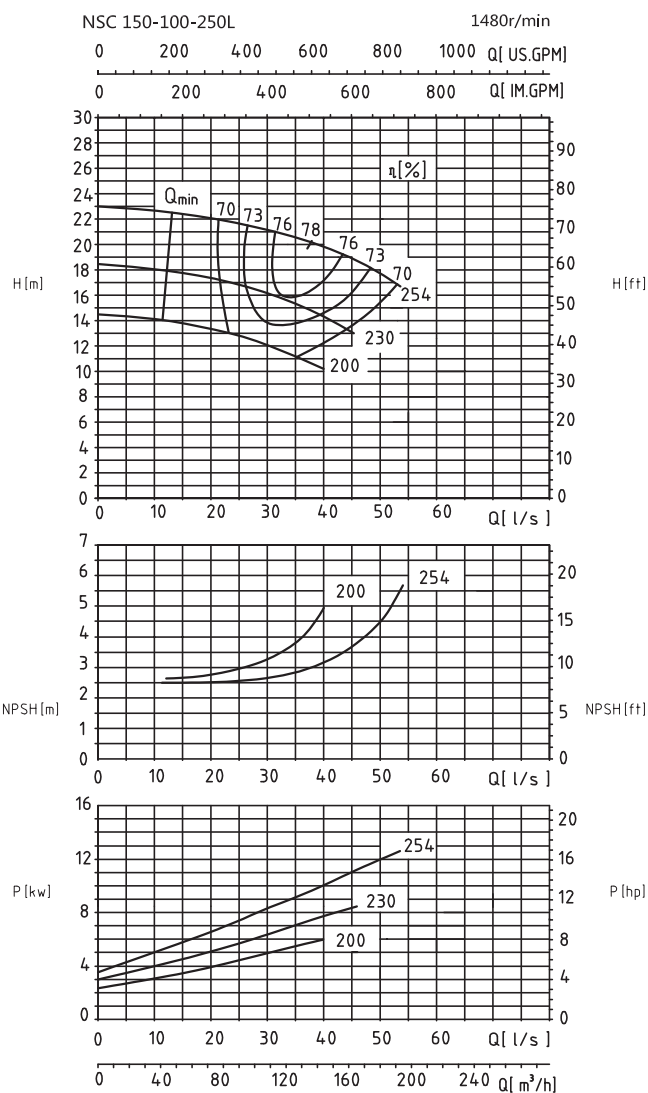
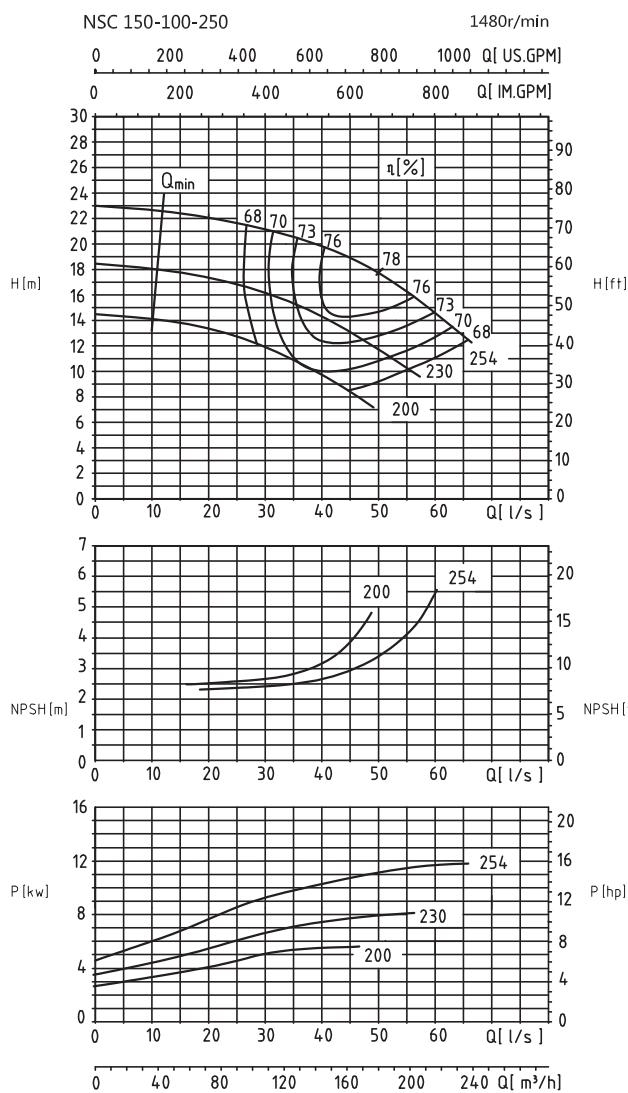

Модель	Производительность		Напор (m)	Скорость (r/min)	Мощность (kw)	Мощность на валу (kw)	КПД (%)	NPSHr (m)	Масса (kg)
	(m³/h)	(L/s)							
NSC150-100-250	120	33.3	20.8	1480	15	9.6	71	2.5	220
	170	47.2	18.4			10.9	78	3.1	
	210	58.3	15			11.8	73	4.8	
NSC150-100-250A	100	27.8	16.5		11	6.5	69	2.5	
	140	38.9	14.5			7.5	74	2.8	
	180	50.0	11.7			8.1	71	4.5	
NSC150-100-250B	100	27.8	12.3		7.5	4.9	68	2.6	
	125	34.7	11			5.4	70	2.8	
	160	44.4	8.5			5.5	68	3.8	
NSC150-100-250L	100	27.8	21.4	15	8.0	73	2.6		
	140	38.9	20		9.8	78	3.1		
	180	50.0	17.7		12.1	72	4.5		
NSC150-100-250LA	90	25.0	16.9	11	5.8	72	2.8		
	120	33.3	15.6		6.8	75	3.2		
	150	41.7	14		7.9	72	4.3		
NSC150-100-250LB	90	25.0	12.8	7.5	4.6	68	3.0		
	110	30.6	12		5.1	70	3.6		
	130	36.1	11		5.7	68	4.0		

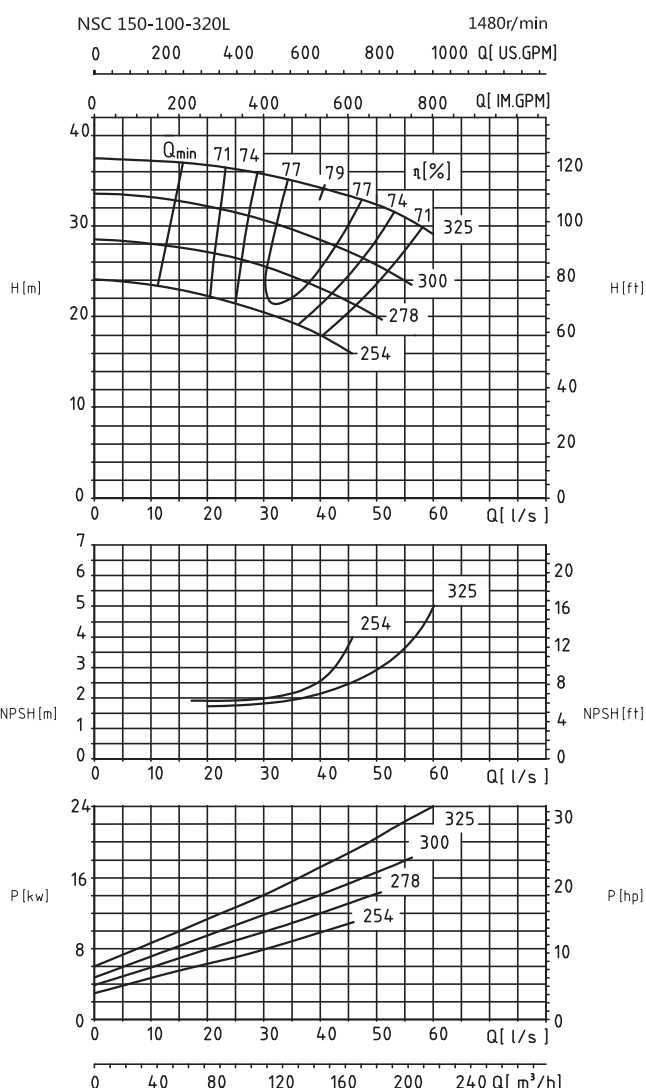
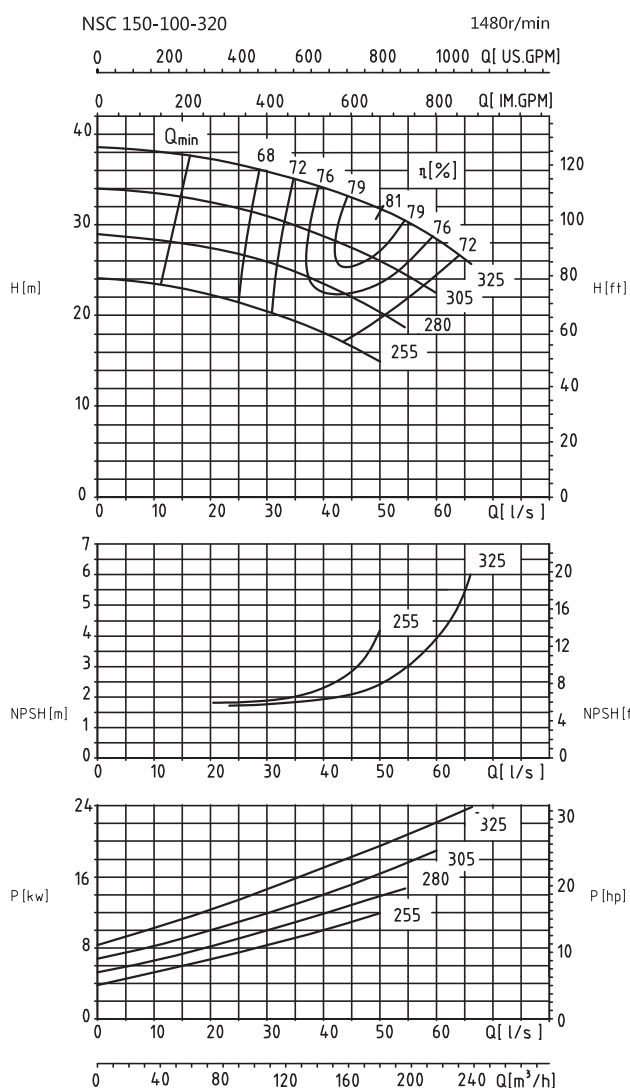

Модель	Производительность		Напор (м)	Скорость (r/min)	Мощность (kw)	Мощность на валу (kw)	КПД (%)	NPSHr (м)	Масса (kg)
	(m ³ /h)	(L/s)							
NSC150-100-320	140	38.9	34.3	1480	30	17.2	76	1.8	230
	180	50.0	32			19.4	81	2.5	
	220	61.1	28			22.4	75	4.3	
NSC150-100-320A	120	33.3	30.1		22	13.7	72	1.9	
	160	44.4	27.6			15.0	80	2.4	
	200	55.6	24			17.7	74	4.5	
NSC150-100-320B	120	33.3	25.2		18.5	11.4	72	1.9	
	150	41.7	23			12.2	77	2.3	
	180	50.0	20.2			13.8	72	3.6	
NSC150-100-320C	110	30.6	20.2		15	8.4	72	1.9	
	140	38.9	18.2			9.4	74	2.3	
	170	47.2	16			10.6	70	3.3	
NSC150-100-320L	100	27.8	36	30	13.4	73	1.8	230	
	140	38.9	34.4		16.8	78	2.1		
	180	50.0	32.3		20.8	76	3.0		
NSC150-100-320LA	90	25.0	31.5	22	10.7	72	1.9		
	130	36.1	29.3		13.3	78	2.1		
	170	47.2	26.5		16.6	74	3.8		
NSC150-100-320LB	80	22.2	26.9	18.5	8.3	71	1.9		
	120	33.3	24.8		10.5	77	2.1		
	160	44.4	22		13.3	72	3.3		
NSC150-100-320LC	80	22.2	22	15	6.8	71	1.9		
	110	30.6	20.2		8.2	74	2.0		
	140	38.9	18.2		9.6	72	2.5		

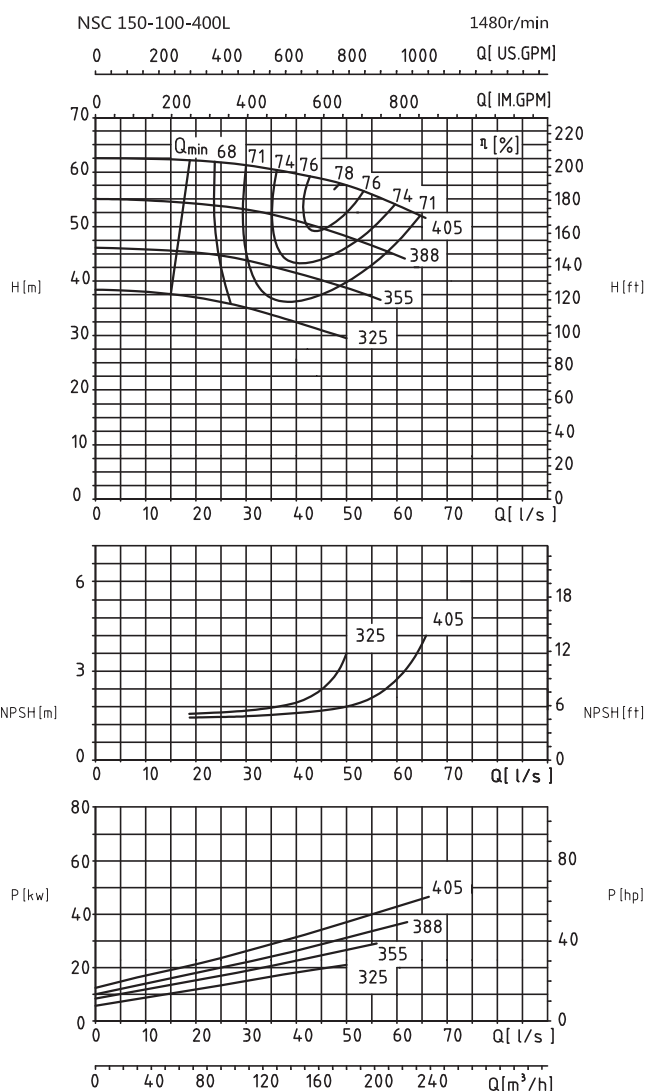
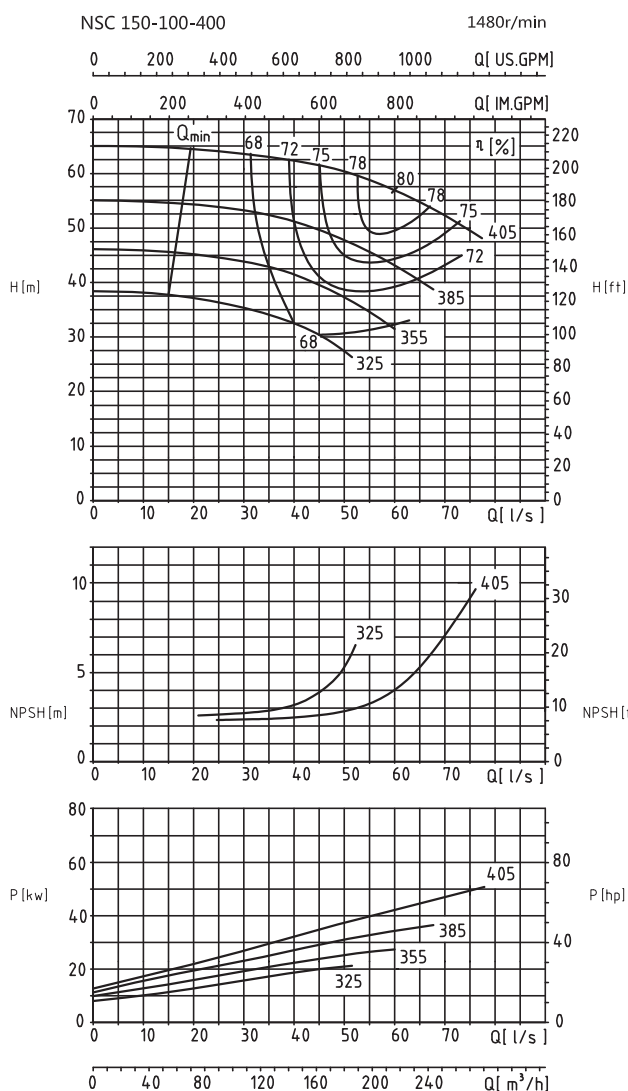

Модель	Производительность		Напор (m)	Скорость (r/min)	Мощность (kw)	Мощность на валу (kw)	КПД (%)	NPSHr (m)	Масса (kg)
	(m³/h)	(L/s)							
NSC150-100-400	160	44.4	61.5	1480	55	35.8	75	2.6	240
	210	58.3	57.5			41.1	80	3.8	
	250	69.4	52.5			46.4	77	6.8	
NSC150-100-400A	140	38.9	51.5		45	27.7	71	2.8	
	182	50.6	48			30.9	77	4.0	
	220	61.1	42.5			34.9	73	6.0	
NSC150-100-400B	130	36.1	42.5		37	22.1	68	2.4	
	155	43.1	40			22.5	75	3.1	
	200	55.6	34.5			27.3	69	6.0	
NSC150-100-400C	130	36.1	33.7	30	17.8	67	2.9		
	150	41.7	32		18.7	70	3.2		
	170	47.2	29.4		20.3	67	4.5		
NSC150-100-400L	130	36.1	60.1	1480	55	28.8	74	1.5	240
	170	47.2	58.2			34.6	78	1.8	
	210	58.3	54.8			42.4	74	2.5	
NSC150-100-400LA	120	33.3	52.5		45	24.2	71	1.4	
	160	44.4	50			28.7	76	1.6	
	200	55.6	46.3			35.0	72	3.0	
NSC150-100-400LB	110	30.6	43		37	18.2	71	1.4	
	150	41.7	40.8			22.8	73	1.6	
	190	52.8	37.7			28.3	69	3.5	
NSC150-100-400LC	100	27.8	35.4	30	14.2	68	1.4		
	130	36.1	33.5		17.0	70	1.5		
	160	44.4	31		20.2	67	2.4		

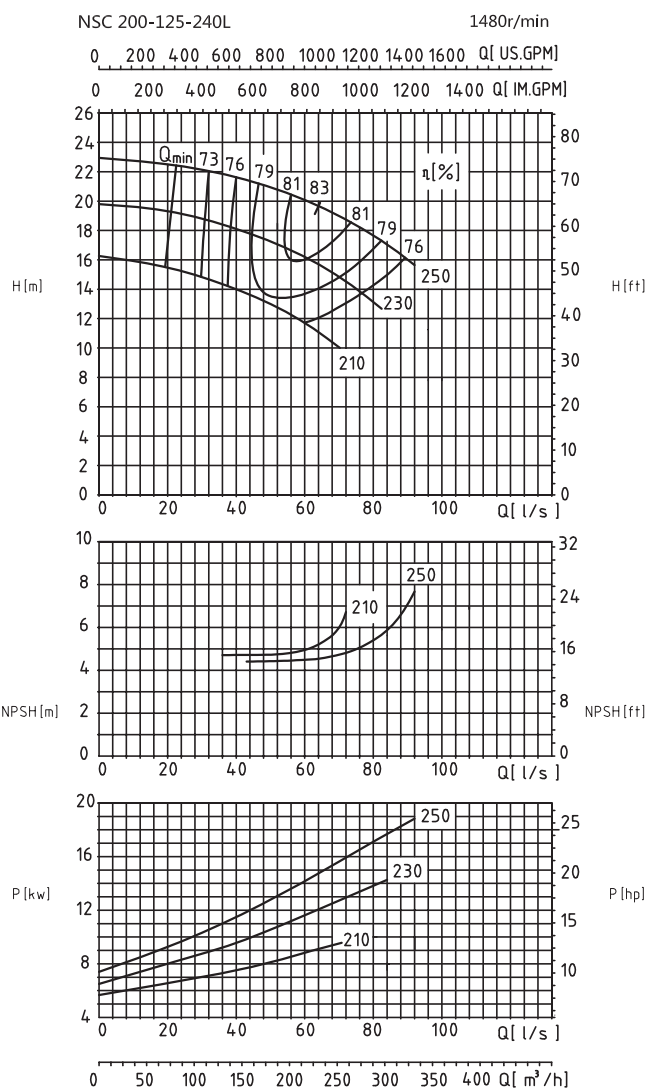
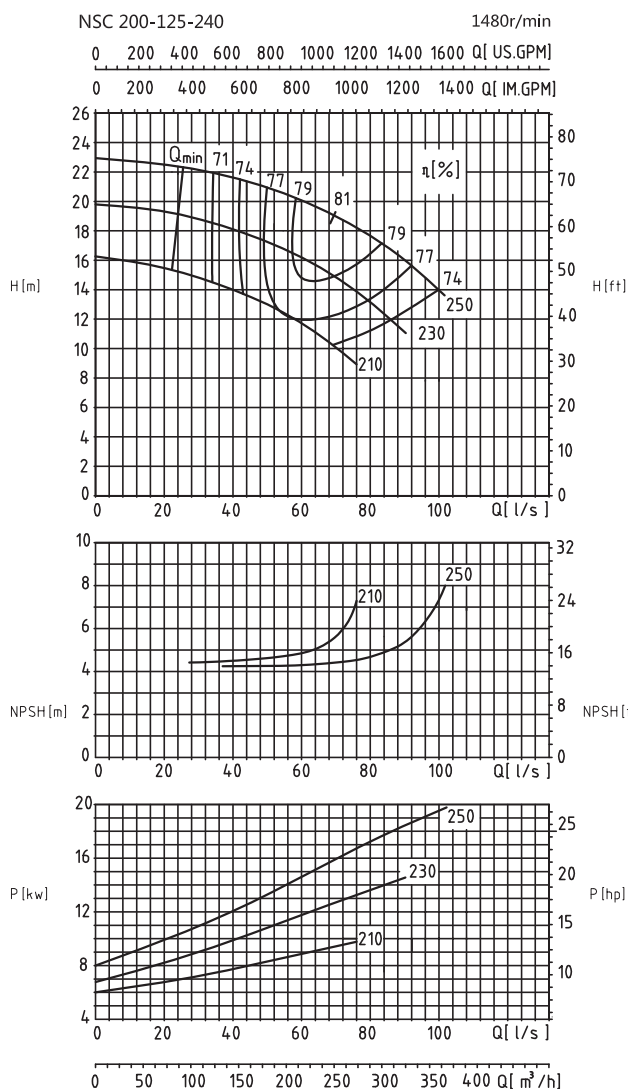

Модель	Производительность		Напор (м)	Скорость (r/min)	Мощность (kw)	Мощность на валу (kw)	КПД (%)	NPSHr (м)	Масса (kg)
	(m³/h)	(L/s)							
NSC200-125-240	200	55.6	20.5	1480	22	14.3	78	4.3	295
	250	69.4	19.1			16.1	81	4.4	
	300	83.3	17.2			17.8	79	4.9	
NSC200-125-240A	175	48.6	17.3		18.5	10.7	77	4.5	
	225	62.5	15.9			12.3	79	4.7	
	275	76.4	13.8			13.3	78	5.6	
NSC200-125-240B	150	41.7	13.9		15	7.7	74	4.5	
	200	55.6	12.3			8.7	77	4.7	
	250	69.4	10.1			9.3	74	5.6	
NSC200-125-240L	150	41.7	21.5	22	11.6	76	4.4		
	225	62.5	19.8		14.6	83	4.5		
	287	79.7	17.7		17.5	79	5.4		
NSC200-125-240LA	150	41.7	18	18.5	9.6	77	4.5		
	212	58.9	16.2		11.6	81	4.7		
	275	76.4	13.8		13.6	76	6.8		
NSC200-125-240LB	137	38.1	14.1	15	6.9	76	4.7		
	187	51.9	12.8		8.4	78	4.8		
	225	62.5	11.3		9.2	75	5.1		

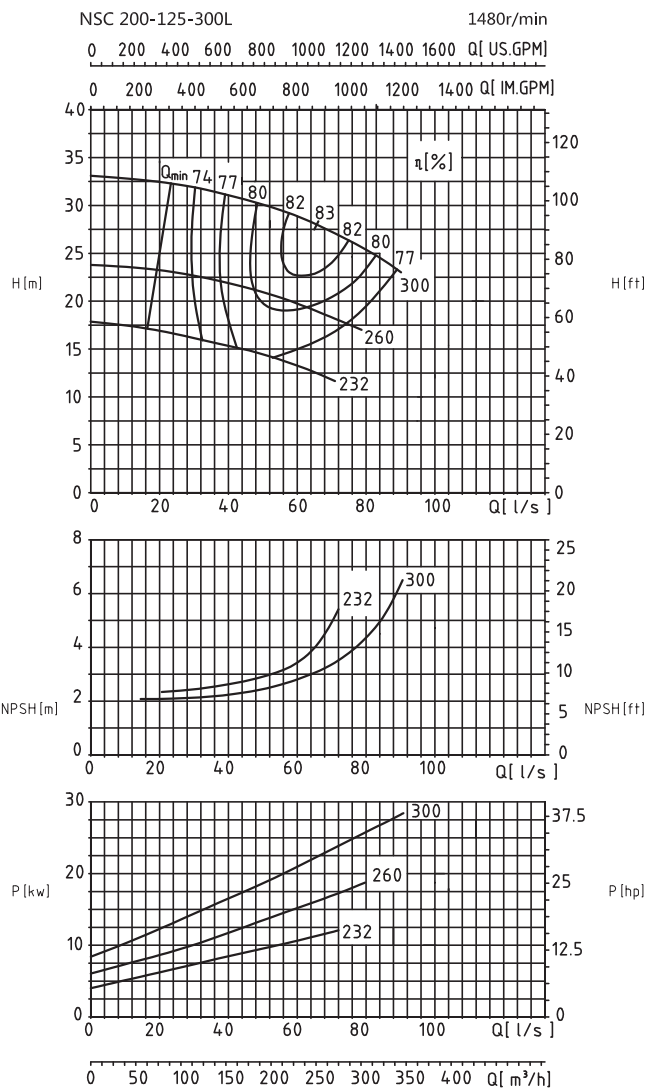
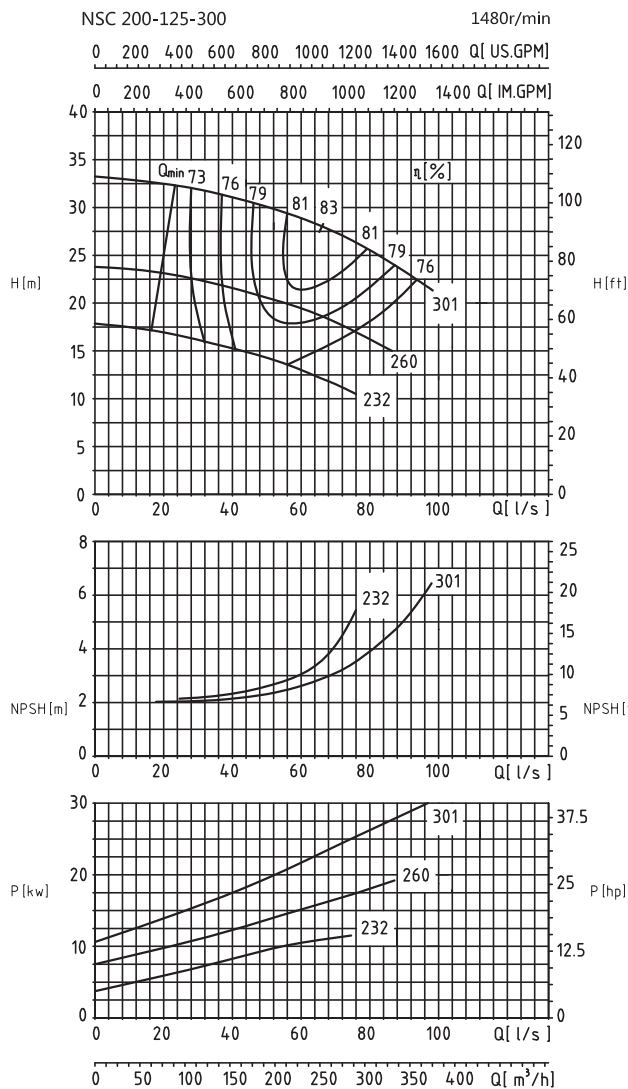

Модель	Производительность		Напор (м)	Скорость (r/min)	Мощность (kw)	Мощность на валу (kw)	КПД (%)	NPSHr (m)	Масса (kg)
	(m³/h)	(L/s)							
NSC200-125-300	200	55.6	29.5	1480	30	20.1	80	2.3	315
	250	69.4	28			23.0	83	2.8	
	300	83.3	25.8			26.0	81	3.7	
NSC200-125-300A	175	48.6	21		22	12.8	78	2.4	
	225	62.5	19.5			14.9	80	2.8	
	275	76.4	17.6			17.1	77	4.0	
NSC200-125-300B	150	41.7	15.2		18.5	8.3	75	2.4	
	200	55.6	13.9			9.8	77	2.7	
	250	69.4	12.3			11.5	73	3.5	
NSC200-125-300L	180	50.0	29.5	1480	30	18.1	80	2.3	315
	225	62.5	28			20.7	83	2.8	
	270	75.0	25.8			23.4	81	3.7	
NSC200-125-300LA	158	43.8	21		22	11.6	78	2.4	
	203	56.3	19.5			13.5	80	2.8	
	248	68.8	17.6			15.4	77	4.0	
NSC200-125-300LB	135	37.5	15.2		15	7.5	75	2.4	
	180	50.0	13.9			8.9	77	2.7	
	225	62.5	12.3			10.3	73	3.5	

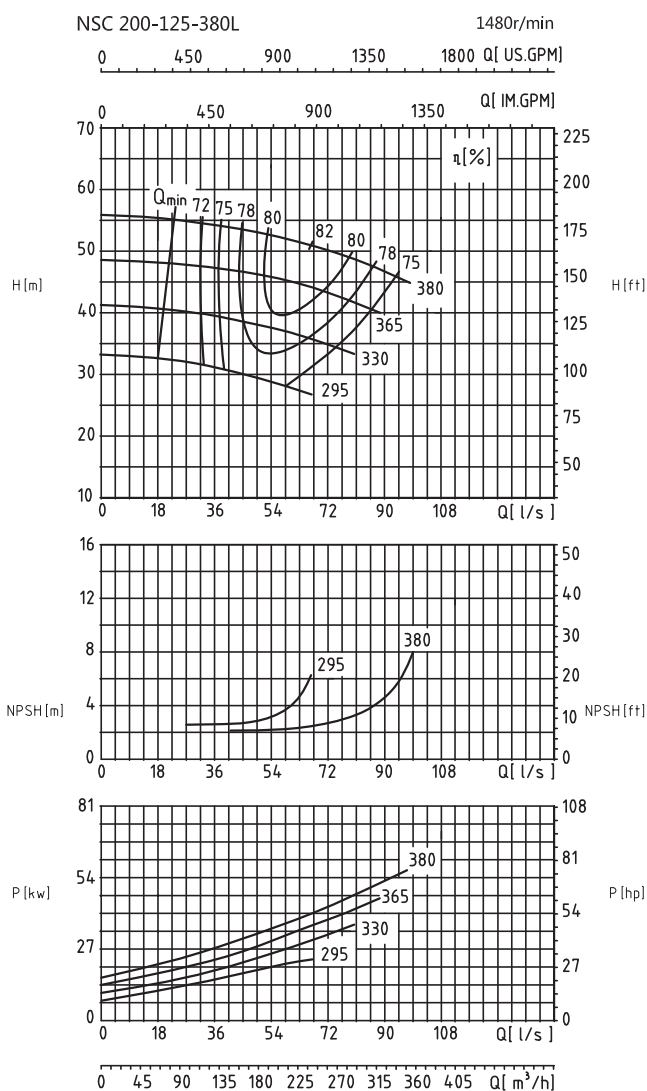
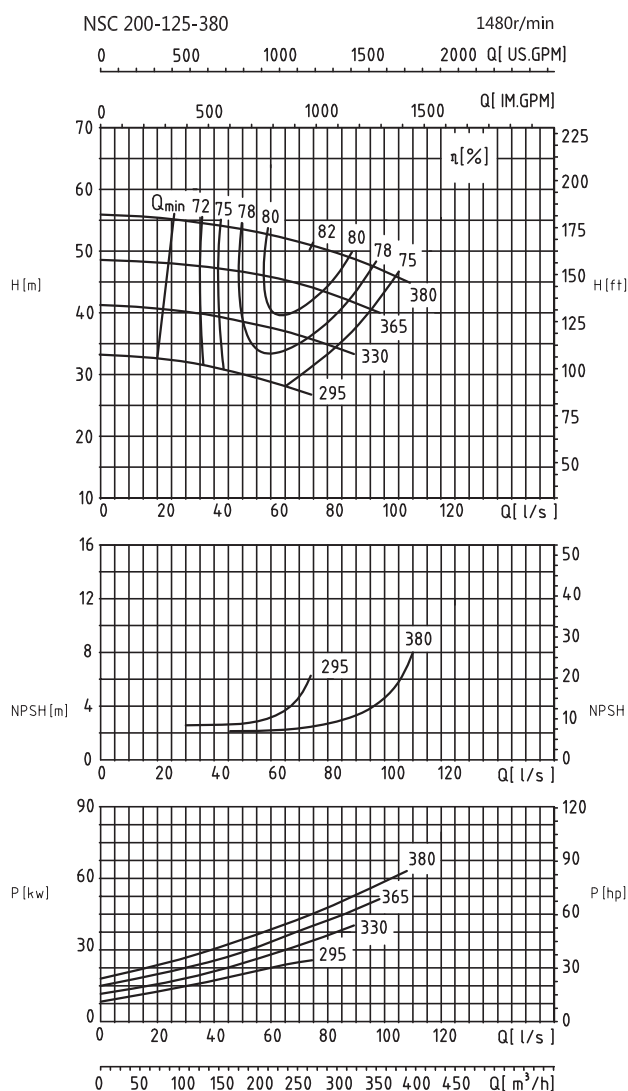

Модель	Производительность		Напор (m)	Скорость (r/min)	Мощность (kw)	Мощность на валу (kw)	КПД (%)	NPSHr (m)	Масса (kg)
	(m³/h)	(L/s)							
NSC200-125-380	175	48.6	53.6	1480	75	33.2	77	2.1	350
	275	76.4	50.3			46.0	82	2.8	
	350	97.2	47.2			57.7	78	4.1	
NSC200-125-380A	150	41.7	47		55	25.6	75	2.2	
	240	66.7	45			36.3	81	2.9	
	325	90.3	41.5			47.7	77	5.2	
NSC200-125-380B	150	41.7	39.6		45	21.9	74	2.2	
	210	58.3	37.5			26.8	80	2.9	
	275	76.4	35			34.5	76	5.0	
NSC200-125-380C	120	33.3	31.5		37	14.9	69	2.2	
	180	50.0	30			18.9	78	2.3	
	250	69.4	27			25.2	73	4.4	
NSC200-125-380L	158	43.8	53.6	1480	75	29.9	77	2.1	350
	248	68.8	50.3			41.4	82	2.8	
	315	87.5	47.2			51.9	78	4.1	
NSC200-125-380LA	135	37.5	47		55	23.1	75	2.2	
	216	60.0	45			32.7	81	2.9	
	293	81.3	41.5			43.0	77	5.0	
NSC200-125-380LB	135	37.5	39.6		45	19.7	74	2.2	
	189	52.5	37.5			24.1	80	2.5	
	248	68.8	35			31.1	76	5.2	
NSC200-125-380LC	108	30.0	31.5		30	13.4	69	2.2	
	162	45.0	30			17.0	78	2.3	
	225	62.5	27			22.7	73	4.5	

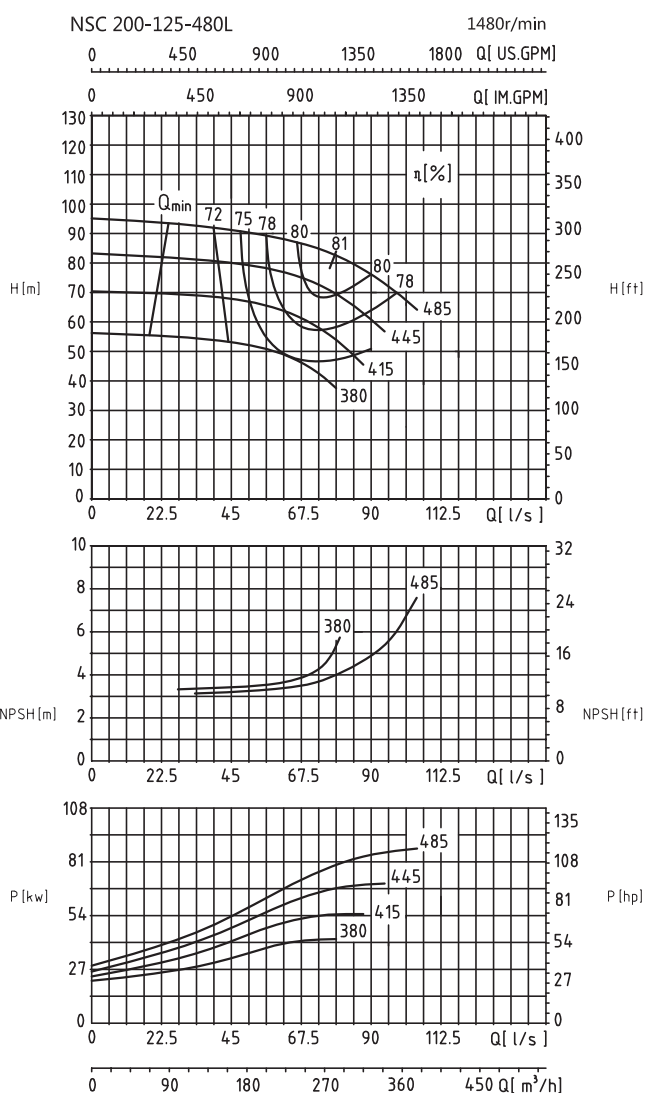
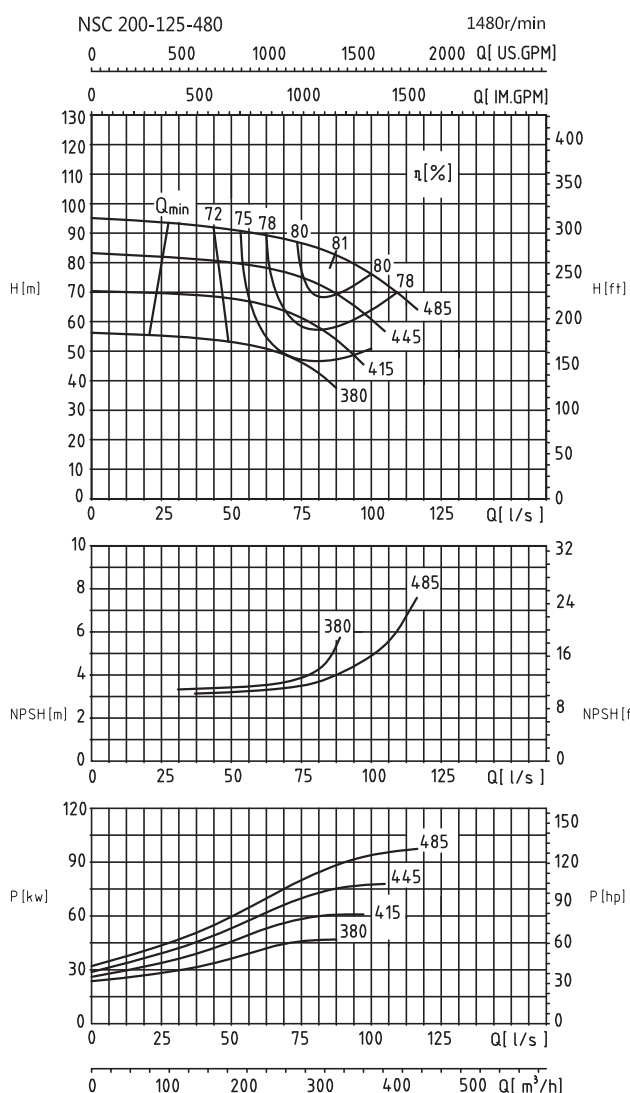

Модель	Производительность		Напор (м)	Скорость (r/min)	Мощность (kw)	Мощность на валу	КПД (%)	NPSHr (м)	Масса (kg)
	(m³/h)	(L/s)				(kw)			
NSC200-125-480	225	62.5	89	1480	110	70.0	78	3.2	390
	300	83.3	84			84.8	81	3.8	
	375	104.2	73.5			95.1	79	5.5	
NSC200-125-480A	175	48.6	80		90	52.3	73	3.3	
	290	80.6	72			71.1	80	4.0	
	350	97.2	62			75.8	78	6.0	
NSC200-125-480B	175	48.6	68		75	44.4	73	3.3	
	256	71.1	64			57.2	78	3.5	
	325	90.3	51.5			60.0	76	5.0	
NSC200-125-480C	175	48.6	52		55	34.4	72	3.4	
	230	63.9	50			41.8	75	3.6	
	275	76.4	45.5			46.1	74	4.0	
NSC200-125-480L	203	56.3	89	1480	110	63.0	78	3.2	390
	270	75.0	84			76.3	81	3.8	
	338	93.8	73.5			85.6	79	5.5	
NSC200-125-480LA	158	43.8	80		90	47.0	73	3.3	
	261	72.5	72			64.0	80	4.0	
	315	87.5	62			68.2	78	6.0	
NSC200-125-480LB	158	43.8	68		75	40.0	73	3.3	
	230	64.0	64			51.5	78	3.5	
	293	81.3	51.5			54.0	76	5.0	
NSC200-125-480LC	158	43.8	52		55	31.0	72	3.4	
	207	57.5	50			37.6	75	3.6	
	248	68.8	45.5			41.5	74	4.0	

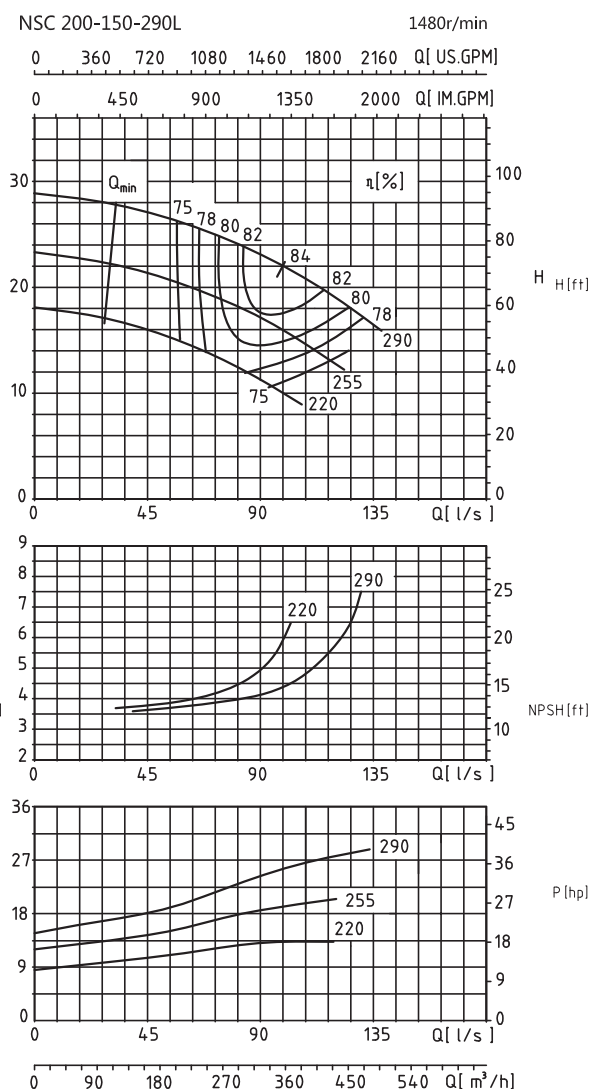
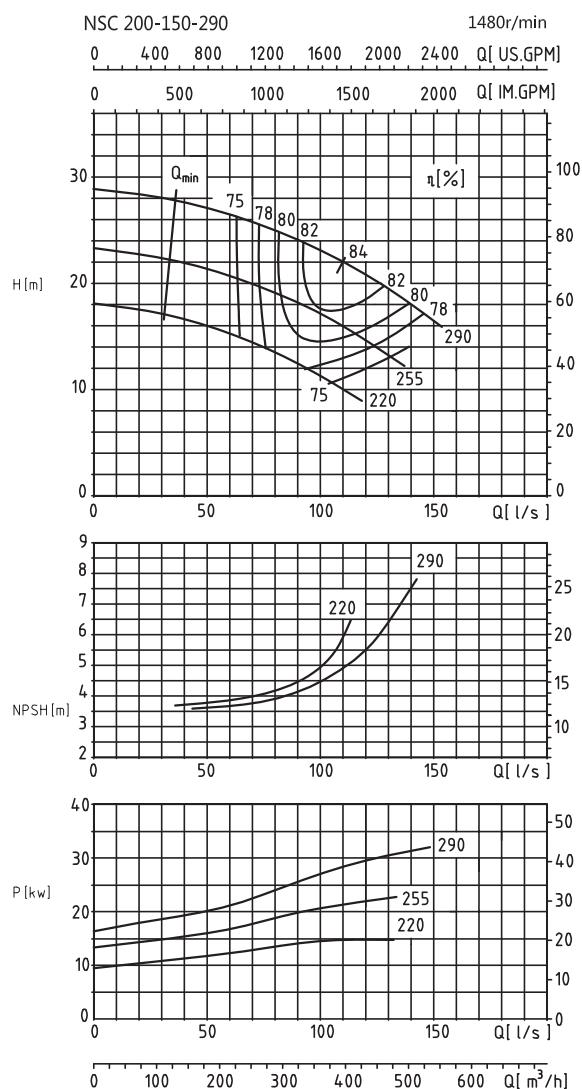

Модель	Производительность		Напор (м)	Скорость (r/min)	Мощность (kw)	Мощность на валу (kw)	КПД (%)	NPSHr (м)	Масса (kg)
	(m³/h)	(L/s)							
NSC200-150-290	300	83.3	24.8	1480	45	24.7	82	4.0	330
	410	113.9	22			29.3	84	5.3	
	500	138.9	18.1			30.8	80	7.5	
NSC200-150-290A	250	69.4	20		30	17.2	79	3.8	
	362	100.6	16.5			19.6	83	4.5	
	450	125.0	14			20.9	82	6.6	
NSC200-150-290B	240	66.7	14.8		18.5	12.7	76	3.9	
	309	85.8	12.8			13.8	78	4.3	
	360	100.0	11.3			14.6	76	4.8	
NSC200-150-290L	270	75.0	24.8	37	22.3	82	4.0		
	369	102.5	22		26.3	84	5.3		
	450	125.0	18.1		27.7	80	7.5		
NSC200-150-290LA	225	62.5	20	30	15.5	79	3.8		
	326	90.5	16.5		17.6	83	4.5		
	405	112.5	14		18.8	82	6.6		
NSC200-150-290LB	216	60.0	14.8	18.5	11.5	76	3.9		
	278	77.3	12.8		12.4	78	4.3		
	324	90.0	11.3		13.1	76	4.8		

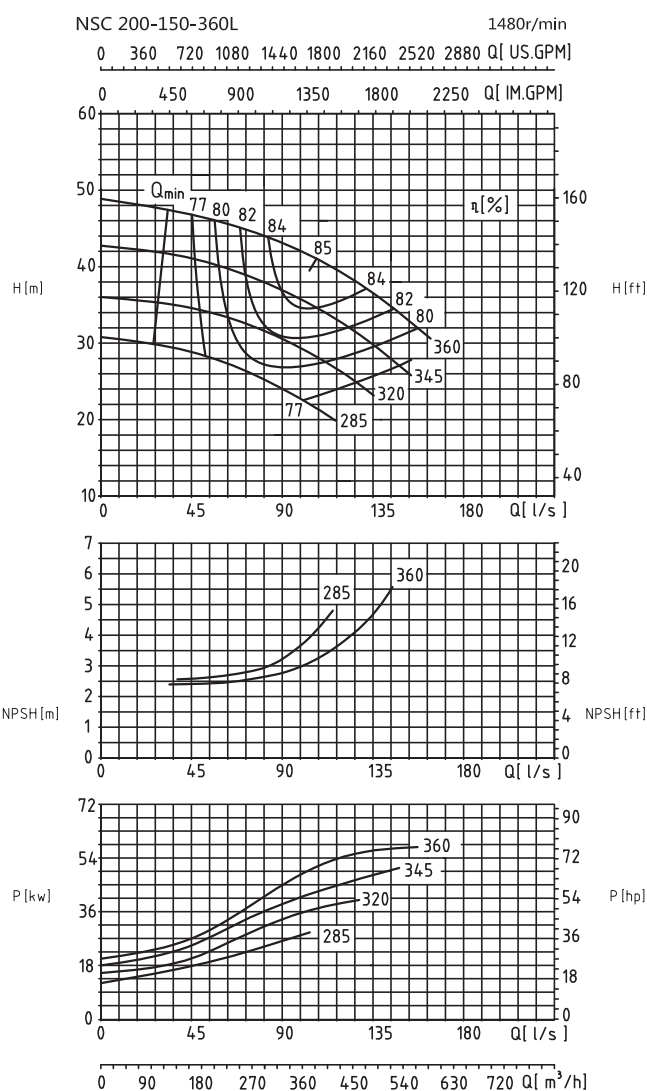
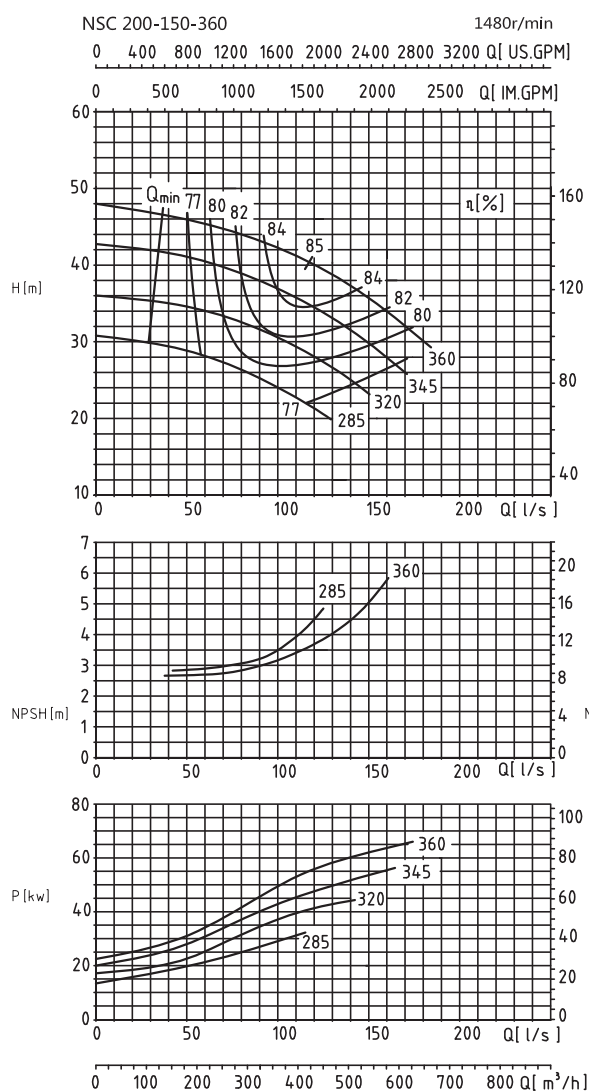

Модель	Производительность		Напор (m)	Скорость (r/min)	Мощность (kw)	Мощность на валу (kw)	КПД (%)	NPSHr (m)	Масса (kg)
	(m ³ /h)	(L/s)							
NSC200-150-360	300	83.3	44	1480	90	43.3	83	2.8	365
	425	118.1	40			54.5	85	3.6	
	550	152.8	35			63.2	83	5.2	
NSC200-150-360A	250	69.4	39.8		75	33.9	80	2.9	
	400	111.1	35.5			46.1	84	3.7	
	500	138.9	31.8			52.8	82	4.6	
NSC200-150-360B	250	69.4	32		55	27.9	78	2.9	
	376	104.4	30			37.5	82	3.4	
	475	131.9	26.3			43.6	78	4.8	
NSC200-150-360C	250	69.4	27.4		45	24.2	77	3.0	
	320	88.9	25.6			28.6	78	3.2	
	400	111.1	23.6			33.4	77	4.0	
NSC200-150-360L	270	75.0	44	75	39.0	83	2.8	365	
	383	106.3	40		49.1	85	3.6		
	495	137.5	35		56.9	83	5.2		
NSC200-150-360LA	225	62.5	39.8	75	30.5	80	2.9		
	360	100.0	35.5		41.5	84	3.7		
	450	125.0	31.8		47.6	82	4.6		
NSC200-150-360LB	225	62.5	32	55	25.2	78	2.9		
	338	94.0	30		33.7	82	3.4		
	428	118.8	26.3		39.3	78	4.8		
NSC200-150-360LC	225	62.5	27.4	45	21.8	77	3.0		
	288	80.0	25.6		25.8	78	3.2		
	360	100.0	23.6		30.1	77	4.0		

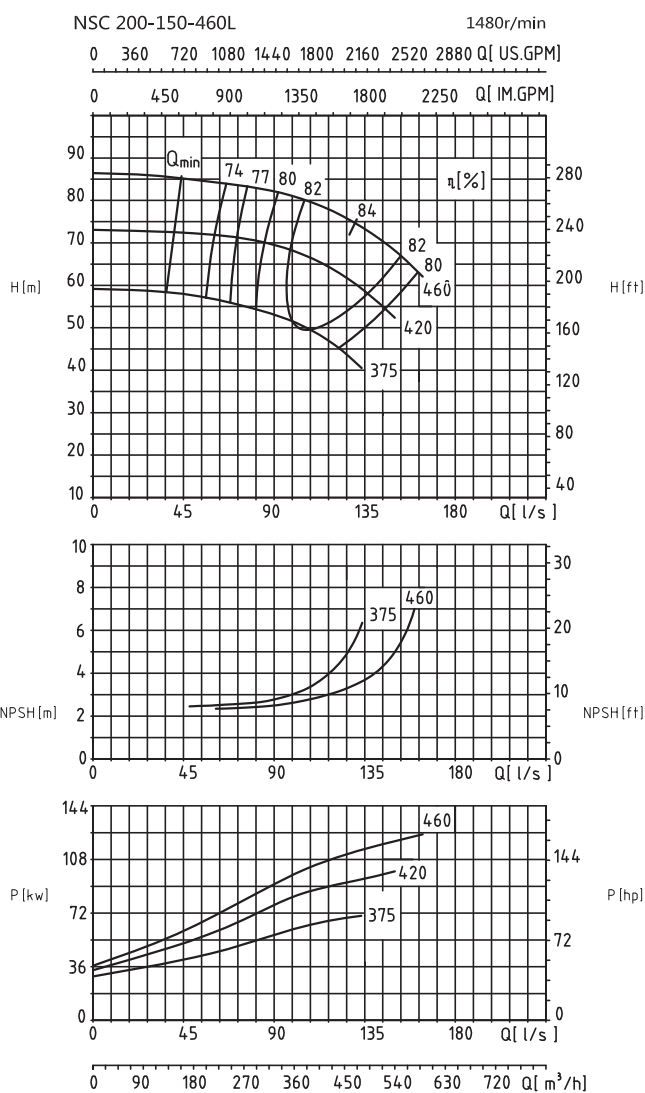
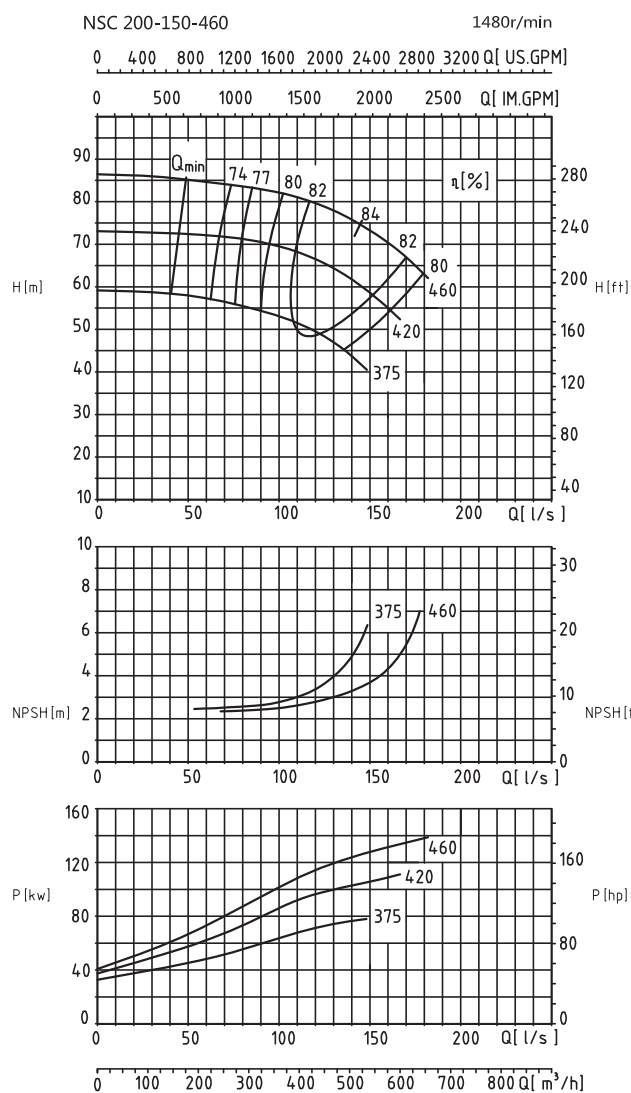

Модель	Производительность		Напор (м)	Скорость (r/min)	Мощность (kw)	Мощность на валу (kw)	КПД (%)	NPSHr (м)	Масса (kg)
	(m ³ /h)	(L/s)							
NSC200-150-460	300	83.3	83.5	1480	160	88.7	77	2.5	460
	520	144.4	75			126.5	84	3.5	
	600	166.7	68			135.6	82	5.0	
NSC200-150-460A	280	77.8	71		132	71.3	76	2.5	
	443	123.1	66			97.2	82	3.2	
	520	144.4	60			103.7	82	4.5	
NSC200-150-460B	275	76.4	56		110	55.2	76	2.6	
	410	113.9	51			69.5	82	3.1	
	475	131.9	46.5			75.2	80	4.2	
NSC200-150-460L	270	75.0	83.5	160	79.8	77	2.5		
	468	130.0	75		113.9	84	3.5		
	540	150.0	68		122.0	82	5.0		
NSC200-150-460LA	252	70.0	71	132	64.2	76	2.5		
	399	110.8	66		87.4	82	3.2		
	468	130.0	60		93.3	82	4.5		
NSC200-150-460LB	248	68.8	56	90	49.7	76	2.6		
	369	102.5	51		62.5	82	3.1		
	428	118.8	46.5		67.7	80	4.2		

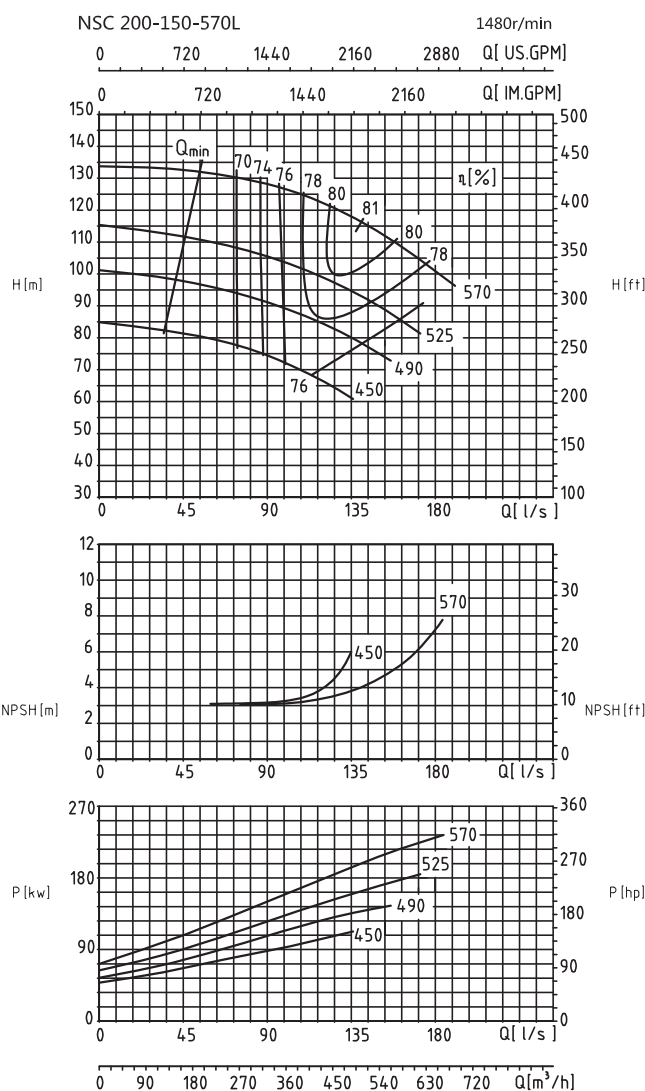
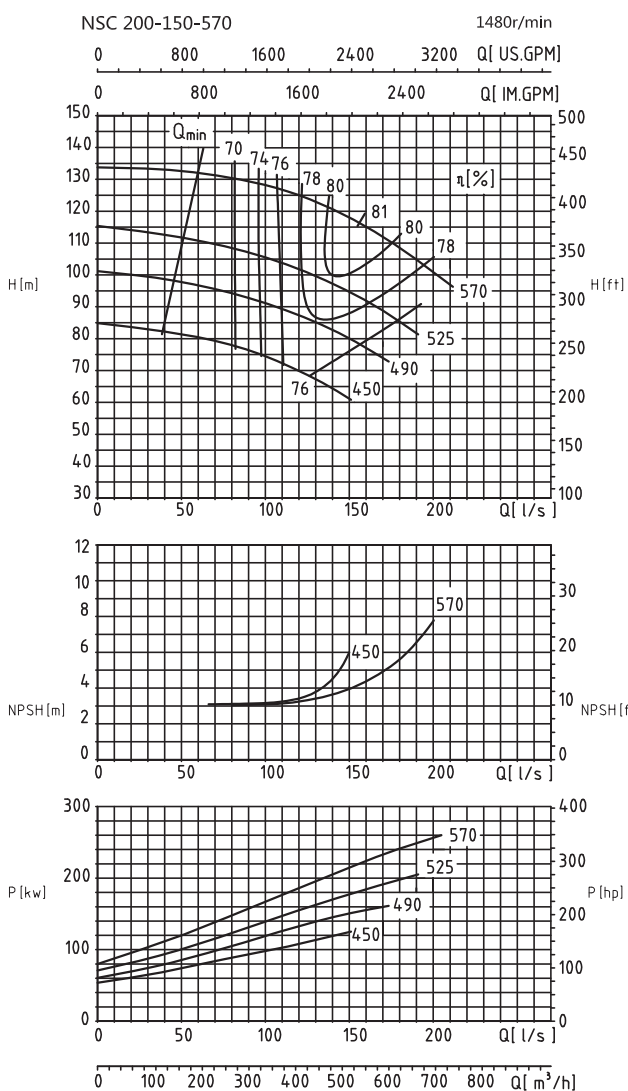

Модель	Производительность		Напор (m)	Скорость (r/min)	Мощность (kw)	Мощность на валу (kw)	КПД (%)	NPSHr (m)	Масса (kg)
	(m ³ /h)	(L/s)							
NSC200-150-570	425	118.1	125	1480	280	188.0	77	3.2	670
	550	152.8	115			212.8	81	4.0	
	675	187.5	105			244.5	79	6.3	
NSC200-150-570A	350	97.2	106		220	136.6	74	3.2	
	500	138.9	97.5			168.2	79	4.0	
	600	166.7	90			191.1	77	6.0	
NSC200-150-570B	300	83.3	93.5		185	109.2	70	3.2	
	450	125.0	86.5			137.8	77	3.5	
	525	145.8	81			152.5	76	4.8	
NSC200-150-570C	300	83.3	77.5		160	90.5	70	3.2	
	400	111.1	72			103.3	76	3.4	
	450	125.0	68.7			110.8	76	3.8	
NSC200-150-570L	383	106.3	125	250	169.2	77	3.2		
	495	137.5	115		191.5	81	4.0		
	608	168.8	105		220.0	79	6.3		
NSC200-150-570LA	315	87.5	106	200	123.0	74	3.2		
	450	125.0	97.5		151.3	79	4.0		
	540	150.0	90		172.0	77	6.0		
NSC200-150-570LB	270	75.0	93.5	160	98.3	70	3.2		
	405	112.5	86.5		124.0	77	3.5		
	473	131.3	81		137.2	76	4.8		
NSC200-150-570LC	270	75.0	77.5	132	81.5	70	3.2		
	360	100.0	72		92.9	76	3.4		
	405	112.5	68.7		99.8	76	3.8		

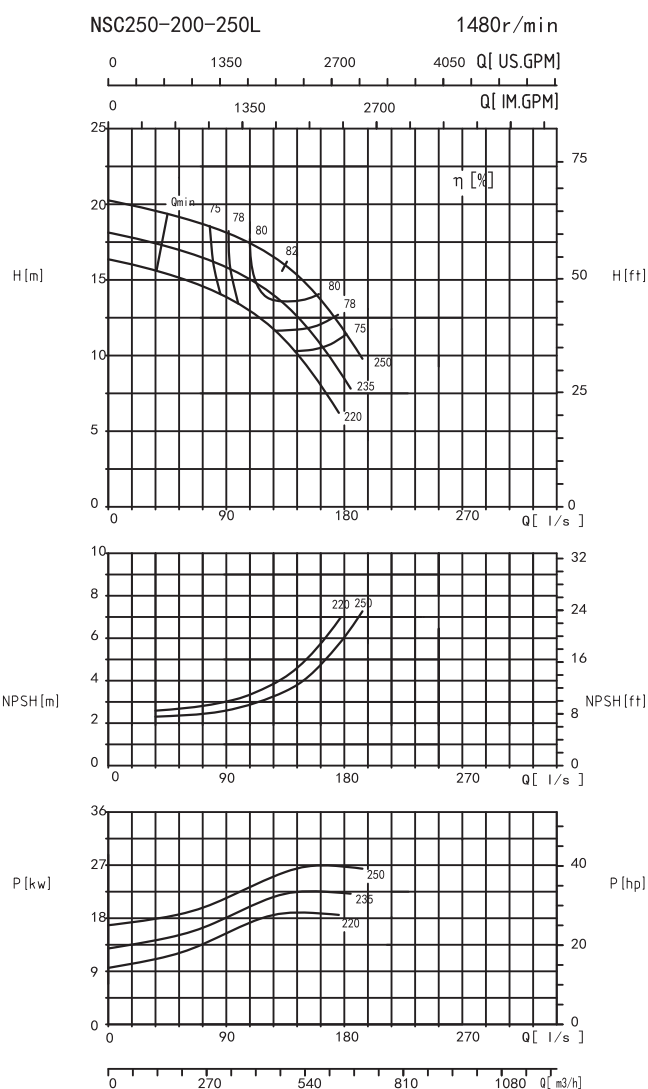
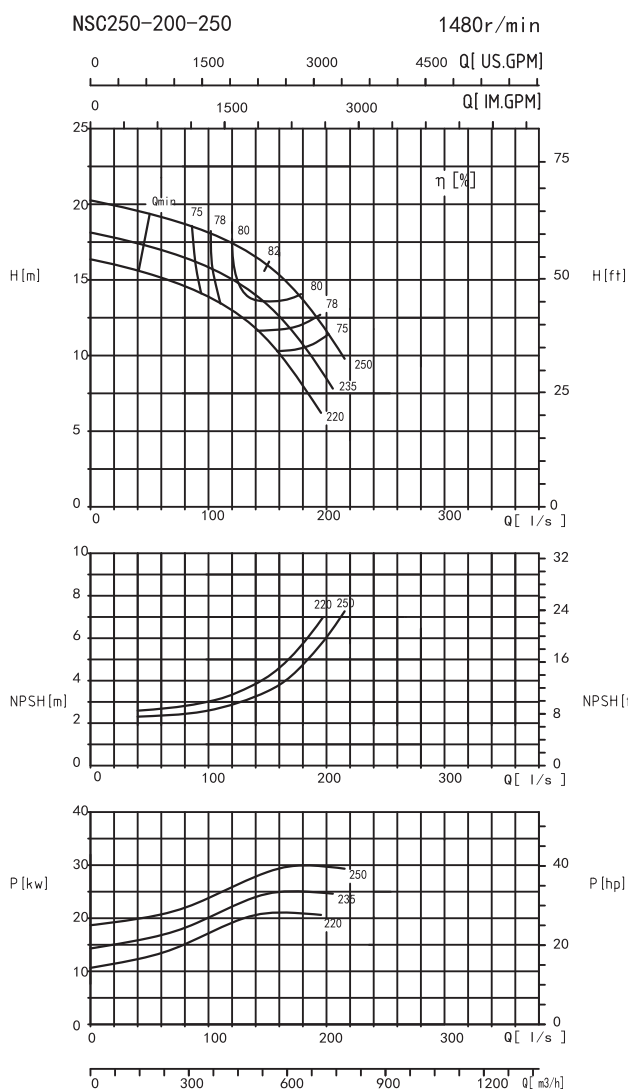

Модель	Производительность		Напор (m)	Скорость (r/min)	Мощность (kw)	Мощность на валу (kw)	КПД (%)	NPSHr (m)	Масса (kg)
	(m³/h)	(L/s)							
NSC250-200-250	415	115.3	17.5	1480	37	25.1	79	2.8	370
	540	150.0	16			28.7	82	3.5	
	675	187.5	13			30.7	78	5.2	
NSC250-200-250A	400	111.1	15.5		30	21.7	78	3.0	
	500	138.9	14			23.8	80	3.5	
	610	169.4	12			25.6	78	4.6	
NSC250-200-250B	380	105.6	13.8		30	18.6	77	3.1	
	460	127.8	12.5			19.8	79	3.6	
	530	147.2	11.2			21.0	77	4.2	
NSC250-200-250L	375	104.2	17.5	37	22.6	79	2.8	370	
	486	135.0	16		25.8	82	3.5		
	610	169.4	13		27.7	78	5.2		
NSC250-200-250LA	360	100.0	15.5	30	19.5	78	3.0		
	450	125.0	14		21.5	80	3.5		
	550	152.8	12		23.1	78	4.6		
NSC250-200-250LB	340	94.4	13.8	30	16.6	77	3.1		
	415	115.3	12.5		17.9	79	3.6		
	480	133.3	11.2		19.0	77	4.2		

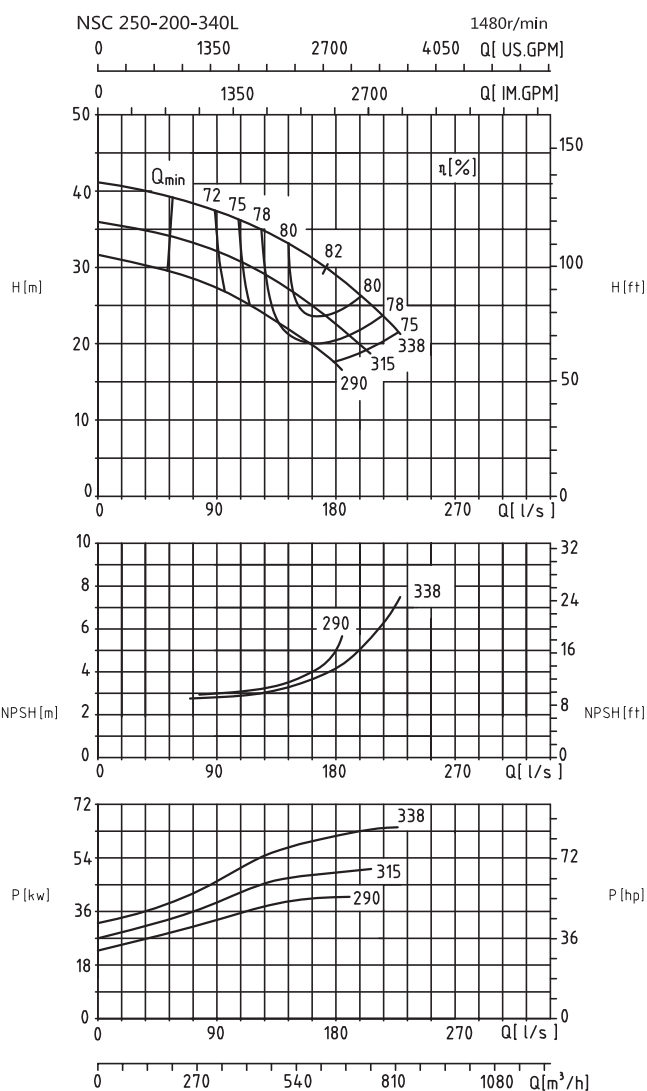
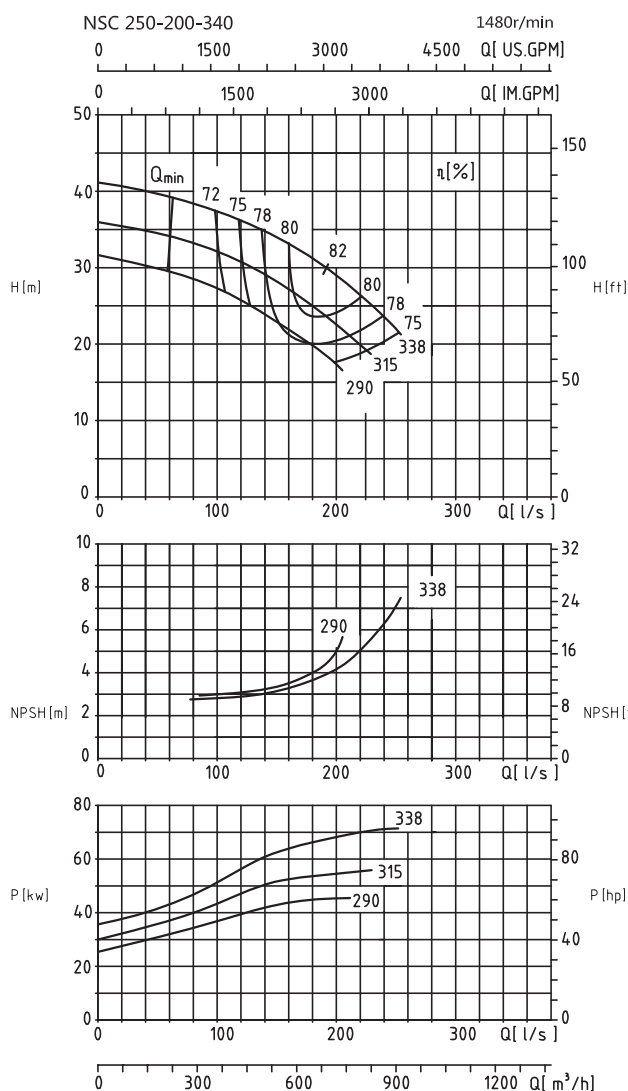

Модель	Производительность		Напор (м)	Скорость (r/min)	Мощность (kw)	Мощность на валу (kw)	КПД (%)	NPSHr (m)	Масса (kg)
	(m³/h)	(L/s)							
NSC250-200-340	450	125.0	35.8	1480	90	57.8	76	2.9	480
	695	193.1	30.5			70.4	82	4.0	
	825	229.2	25			71.1	79	5.6	
NSC250-200-340A	450	125.0	30.3		75	49.5	75	3.0	
	650	180.6	25.5			56.5	80	3.9	
	750	208.3	21.6			56.6	78	5.2	
NSC250-200-340B	375	104.2	27		55	38.9	71	3.0	
	601	166.9	21.3			44.7	78	3.8	
	675	187.5	19			45.4	77	4.8	
NSC250-200-340L	405	112.5	35.8	90	52.0	76	2.9	480	
	626	173.8	30.5		63.4	82	4.0		
	743	206.3	25		64.0	79	5.6		
NSC250-200-340LA	405	112.5	30.3	75	44.6	75	3.0		
	585	162.5	25.5		50.8	80	3.9		
	675	187.5	21.6		50.9	78	5.2		
NSC250-200-340LB	338	93.8	27	55	35.0	71	3.0		
	541	150.3	21.3		40.3	78	3.8		
	608	168.8	19		40.8	77	4.8		

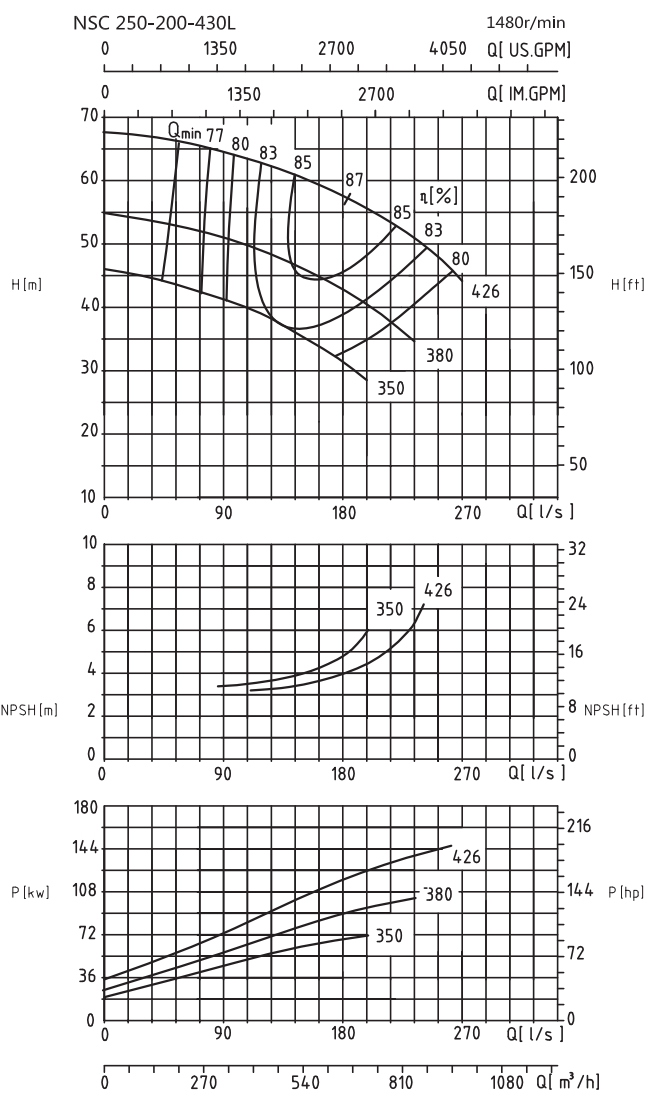
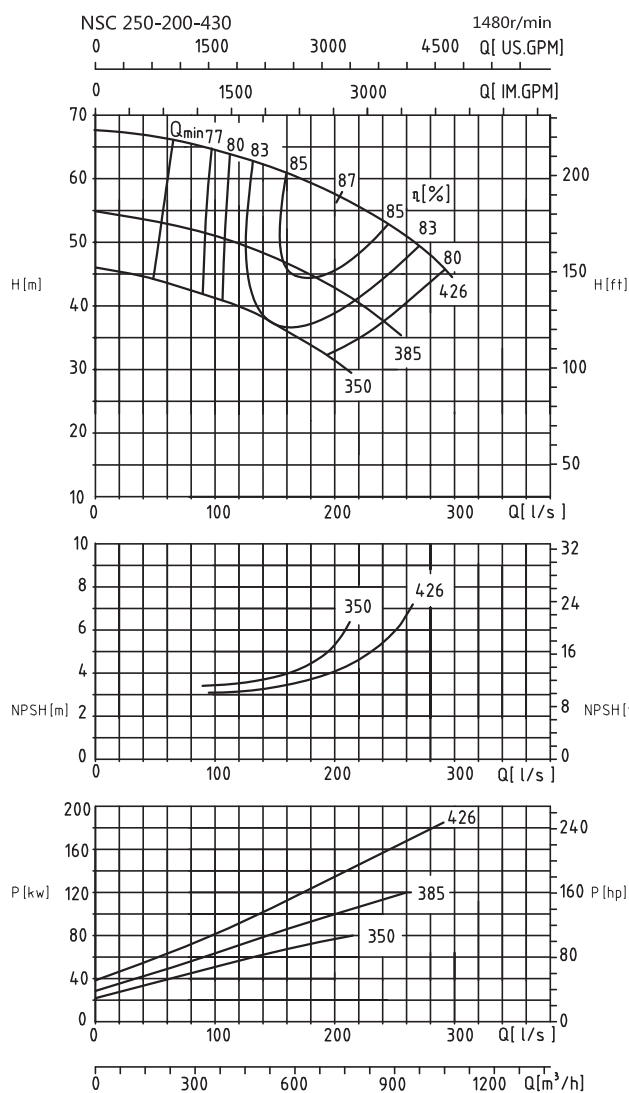

Модель	Производительность		Напор (м)	Скорость (r/min)	Мощность (kw)	Мощность на валу (kw)	КПД (%)	NPSHr (м)	Масса (kg)
	(m ³ /h)	(L/s)							
NSC250-200-430	450	125.0	63	1480	185	95.4	81	3.2	560
	700	194.4	58.4			128.0	87	4.0	
	850	236.1	54.8			149.3	85	5.0	
NSC250-200-430A	450	125.0	49.5		132	73.1	83	3.3	
	645	179.2	45			93.1	85	4.0	
	825	229.2	39.5			109.6	81	5.5	
NSC250-200-430B	375	104.2	41		110	53.0	79	3.4	
	580	161.1	36			68.6	83	3.8	
	700	194.4	32			78.3	78	4.5	
NSC250-200-430L	405	112.5	63	160	85.8	81	3.2	560	
	630	175.0	58.4		115.2	87	4.0		
	765	212.5	54.8		134.4	85	5.0		
NSC250-200-430LA	405	112.5	49.5	132	65.8	83	3.3		
	581	161.3	45		83.7	85	4.0		
	743	206.3	39.5		98.7	81	5.5		
NSC250-200-430LB	338	93.8	41	110	47.7	79	3.4		
	522	145.0	36		61.7	83	3.8		
	630	175.0	32		² 70.4	78	4.5		

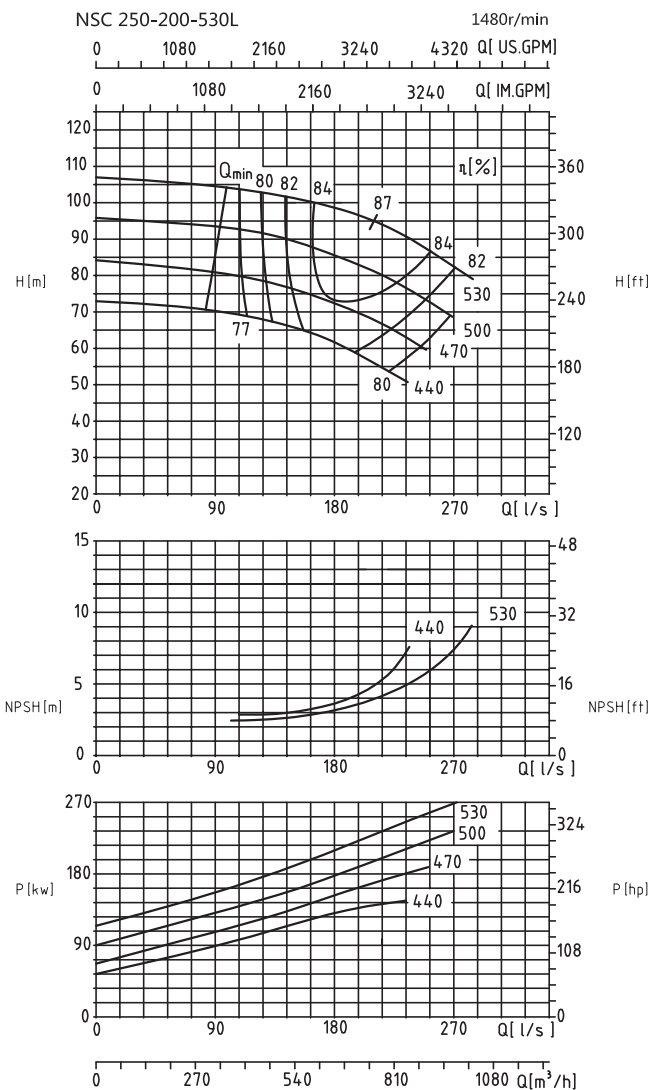
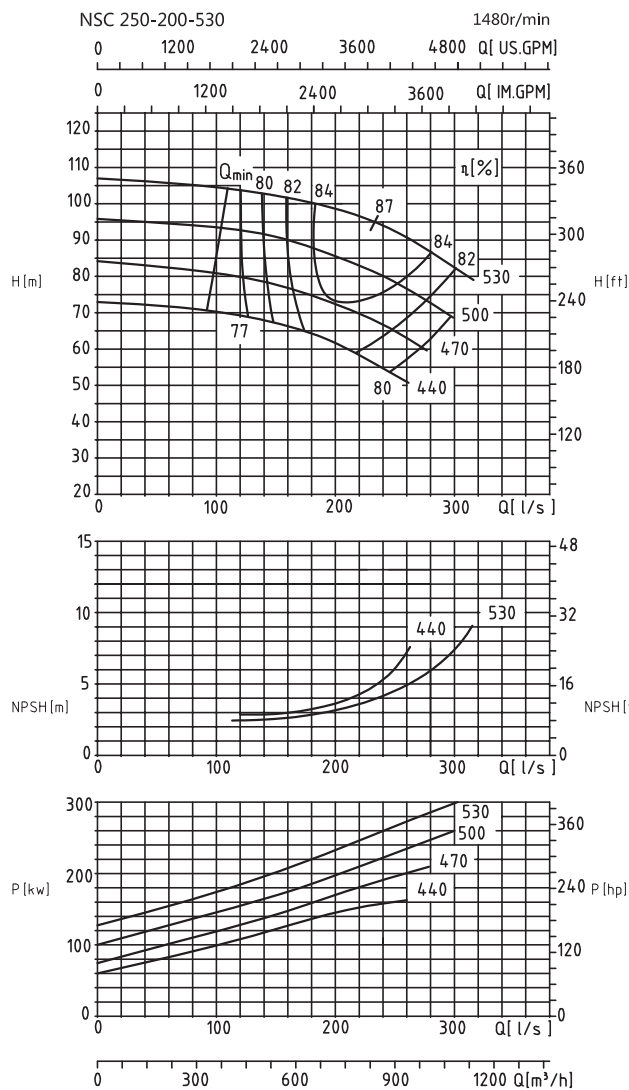

Модель	Производительность		Напор (м)	Скорость (r/min)	Мощность (kw)	Мощность на валу (kw)	КПД (%)	NPSHr (м)	Масса (kg)
	(m ³ /h)	(L/s)							
NSC250-200-530	675	187.5	100	1480	315	227.1	81	3.0	710
	825	229.2	95.1			248.6	86	3.8	
	975	270.8	88.8			280.9	84	5.5	
NSC250-200-530A	600	166.7	89.5		280	176.3	83	2.9	
	750	208.3	84.5			203.2	85	3.8	
	900	250.0	78.3			228.6	84	5.4	
NSC250-200-530B	600	166.7	76.2		220	151.9	82	2.9	
	750	208.3	71.2			175.3	83	3.7	
	900	250.0	65			194.4	82	5.5	
NSC250-200-530C	525	145.8	67.5		185	120.7	80	3.0	
	675	187.5	63.2			141.8	82	3.2	
	825	229.2	56.6			157.1	81	5.0	
NSC250-200-530L	608	168.8	100	1480	204.4	81	3.0	710	
	743	206.3	95.1		223.7	86	3.8		
	878	243.8	88.8		252.8	84	5.5		
NSC250-200-530LA	540	150.0	89.5		250	158.7	83		2.9
	675	187.5	84.5			182.9	85		3.8
	810	225.0	78.3			205.7	84		5.4
NSC250-200-530LB	540	150.0	76.2		200	136.7	82		2.9
	675	187.5	71.2			157.8	83		3.7
	810	225.0	65			175.0	82		5.5
NSC250-200-530LC	473	131.3	67.5		160	108.6	80		3.0
	608	168.8	63.2			127.6	82		3.2
	743	206.3	56.6			141.4	81		5.0

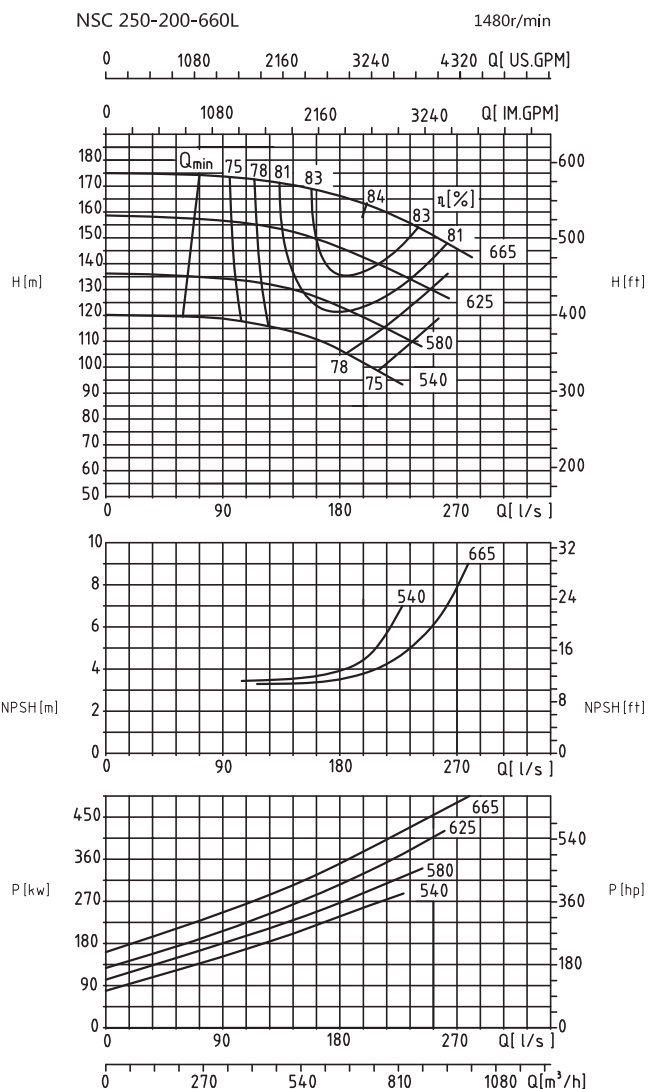
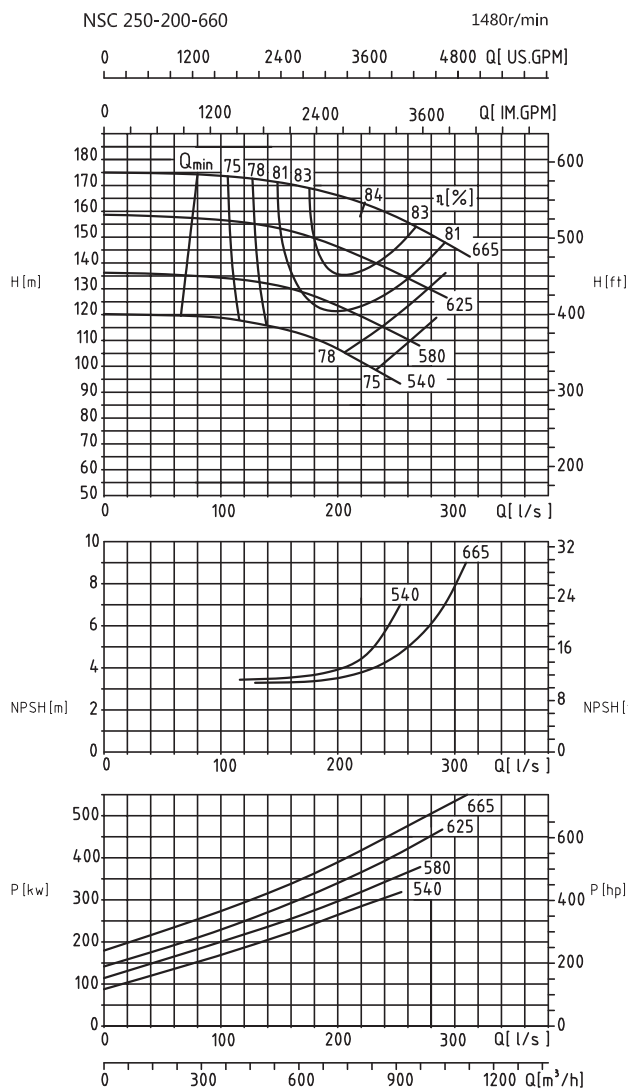

Модель	Производительность		Напор (m)	Скорость (r/min)	Мощность (kw)	Мощность на валу (kw)	КПД (%)	NPSHr (m)	Масса (kg)
	(m³/h)	(L/s)							
NSC250-200-660	600	166.7	170	1480	560	339.0	82	3.3	995
	825	229.2	162			433.6	84	4.0	
	975	270.8	153			495.7	82	5.6	
NSC250-200-660A	600	166.7	151.4		500	301.9	82	3.5	
	750	208.3	145			357.0	83	3.8	
	900	250.0	136.3			407.7	82	5.4	
NSC250-200-660B	525	145.8	131.6		400	238.3	79	3.4	
	675	187.5	125.8			285.7	81	3.6	
	825	229.2	117.3			333.8	79	4.6	
NSC250-200-660C	525	145.8	115		355	210.9	78	3.4	
	650	180.6	110.2			244.0	80	3.8	
	750	208.3	105			278.7	77	4.1	
NSC250-200-660L	540	150.0	170	500	305.1	82	3.3		
	743	206.3	162		390.2	84	4.0		
	878	243.8	153		446.2	82	5.6		
NSC250-200-660LA	540	150.0	151.4	450	271.7	82	3.5		
	675	187.5	145		321.3	83	3.8		
	810	225.0	136.3		366.9	82	5.4		
NSC250-200-660LB	473	131.3	131.6	355	214.5	79	3.4		
	608	168.8	125.8		257.1	81	3.6		
	743	206.3	117.3		300.4	79	4.6		
NSC250-200-660LC	473	131.3	115	315	189.8	78	3.4		
	585	162.5	110.2		219.6	80	3.8		
	675	187.5	105		250.8	77	4.1		

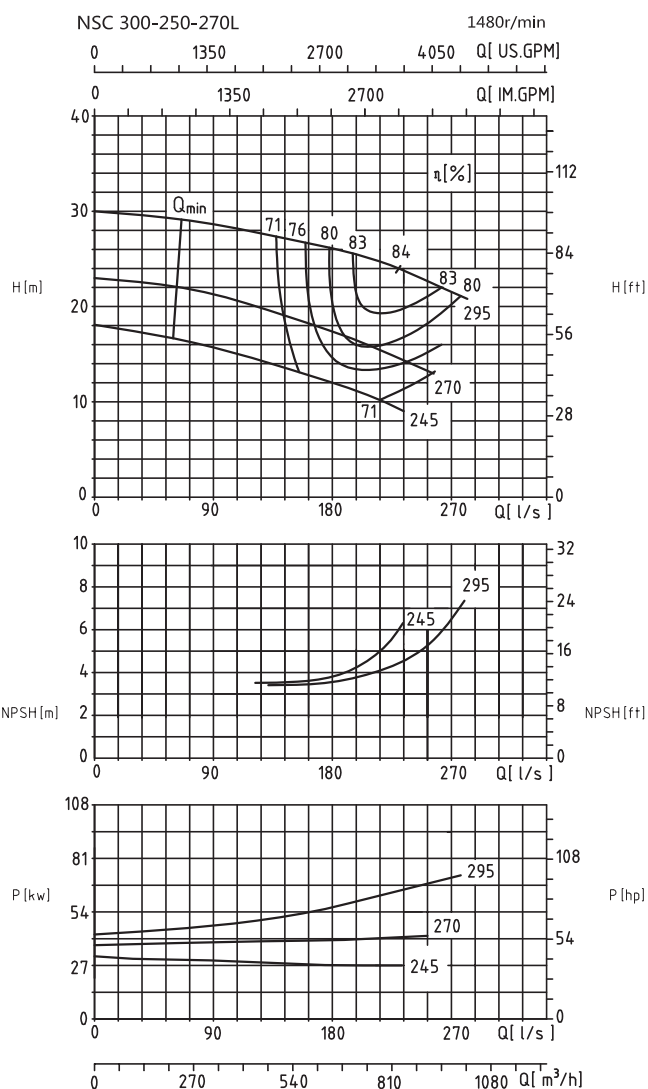
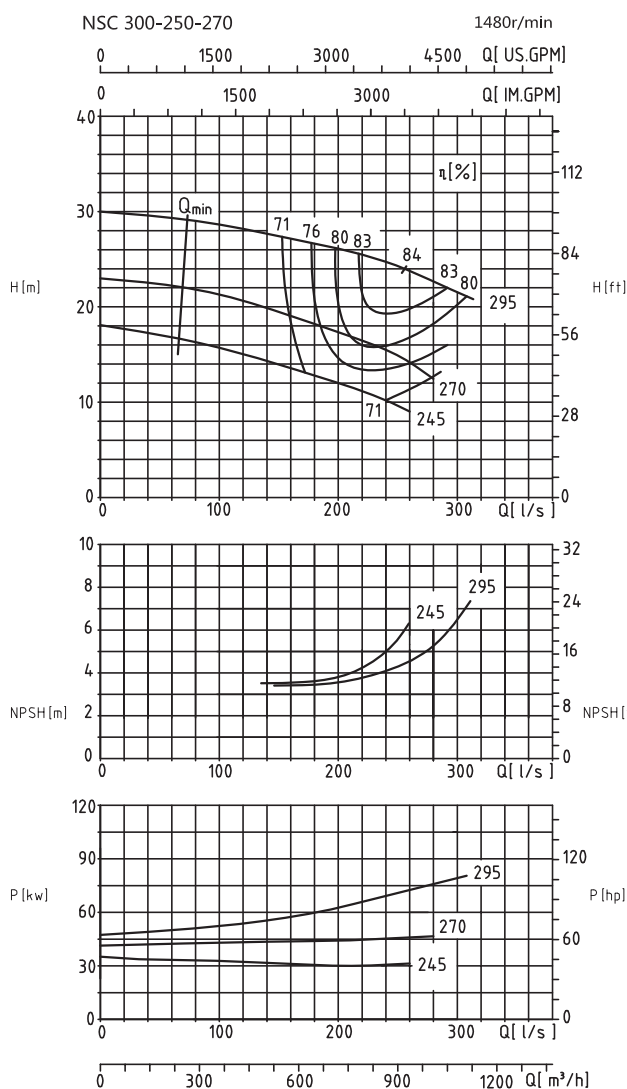

Модель	Производительность		Напор (m)	Скорость (r/min)	Мощность (kw)	Мощность на валу (kw)	КПД (%)	NPSHr (m)	Масса (kg)
	(m³/h)	(L/s)							
NSC300-250-270	650	180.6	26.8	1480	90	64.1	74	3.5	650
	825	229.2	25			67.7	83	4.0	
	975	270.8	23			73.6	83	5.0	
NSC300-250-270A	650	180.6	18		75	44.3	72	3.6	
	750	208.3	17			43.4	80	3.8	
	900	250.0	15			47.2	78	5.0	
NSC300-250-270B	650	180.6	12.7		45	31.7	71	3.7	
	750	208.3	11.5			31.8	74	4.0	
	850	236.1	10.5			34.3	71	4.7	
NSC300-250-270L	585	162.5	26.8	90	57.7	74	3.5	650	
	743	206.3	25		60.9	83	4.0		
	878	243.8	23		66.3	83	5.0		
NSC300-250-270LA	585	162.5	18	55	39.9	72	3.6		
	675	187.5	17		39.1	80	3.8		
	810	225.0	15		42.4	78	5.0		
NSC300-250-270LB	585	162.5	12.7	45	28.5	71	3.7		
	675	187.5	11.5		28.6	74	³ 4.0		
	765	212.5	10.5		² 30.8	71	4.7		

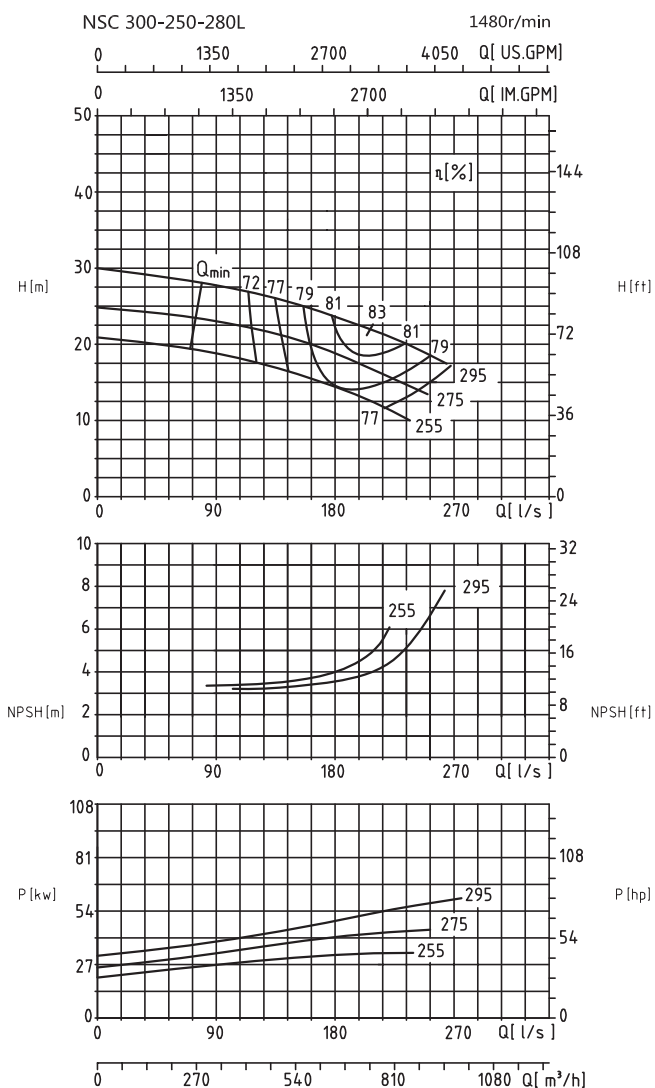
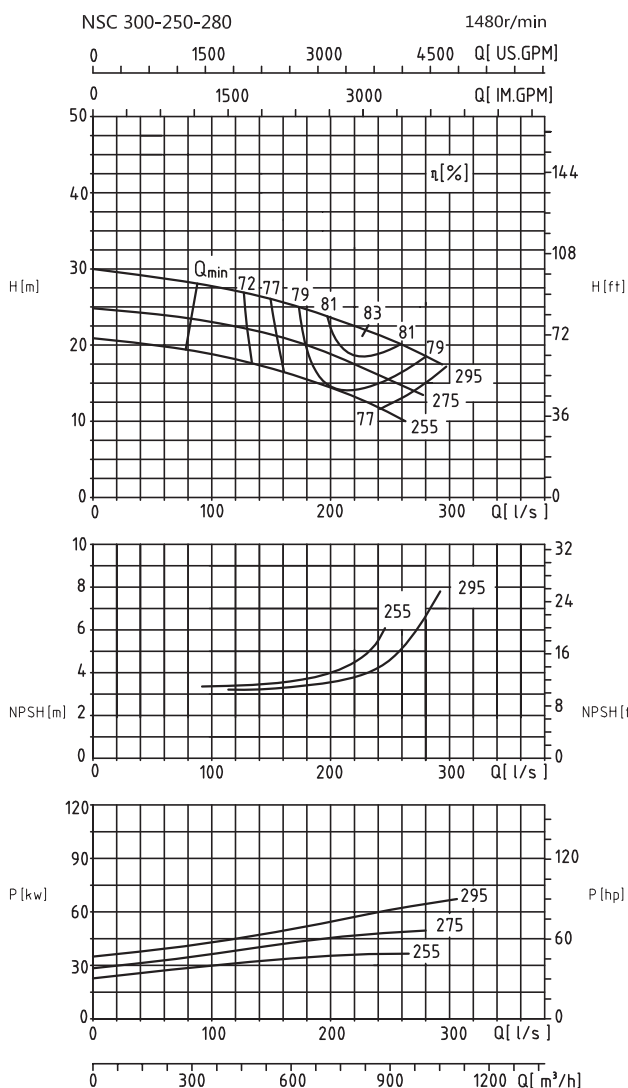

Модель	Производительность		Напор (м)	Скорость (r/min)	Мощность (kw)	Мощность на валу (kw)	КПД (%)	NPSHr (m)	Масса (kg)
	(m³/h)	(L/s)							
NSC300-250-280	675	187.5	24.4	1480	90	56.1	80	3.5	650
	825	229.2	22			59.6	83	4.0	
	975	270.8	19.2			63.8	80	6.0	
NSC300-250-280A	600	166.7	20.6		75	43.2	78	3.5	
	750	208.3	18.4			47.0	80	3.8	
	900	250.0	15.4			47.8	79	5.6	
NSC300-250-280B	600	166.7	16.5		55	35.0	77	3.7	
	675	187.5	15			35.4	78	3.9	
NSC300-250-280L	825	229.2	12.5		75	36.5	77	4.7	
	608	168.8	24.4	50.5		80	3.5		
	743	206.3	22	53.6		83	4.0		
NSC300-250-280LA	878	243.8	19.2	55	57.4	80	6.0		
	540	150.0	20.6		38.9	78	3.5		
	675	187.5	18.4		42.3	80	3.8		
NSC300-250-280LB	810	225.0	15.4	45	43.0	79	5.6		
	540	150.0	16.5		31.5	77	3.7		
NSC300-250-280LB	608	168.8	15	45	31.8	78	3.9		
	743	206.3	12.5		32.8	77	4.7		

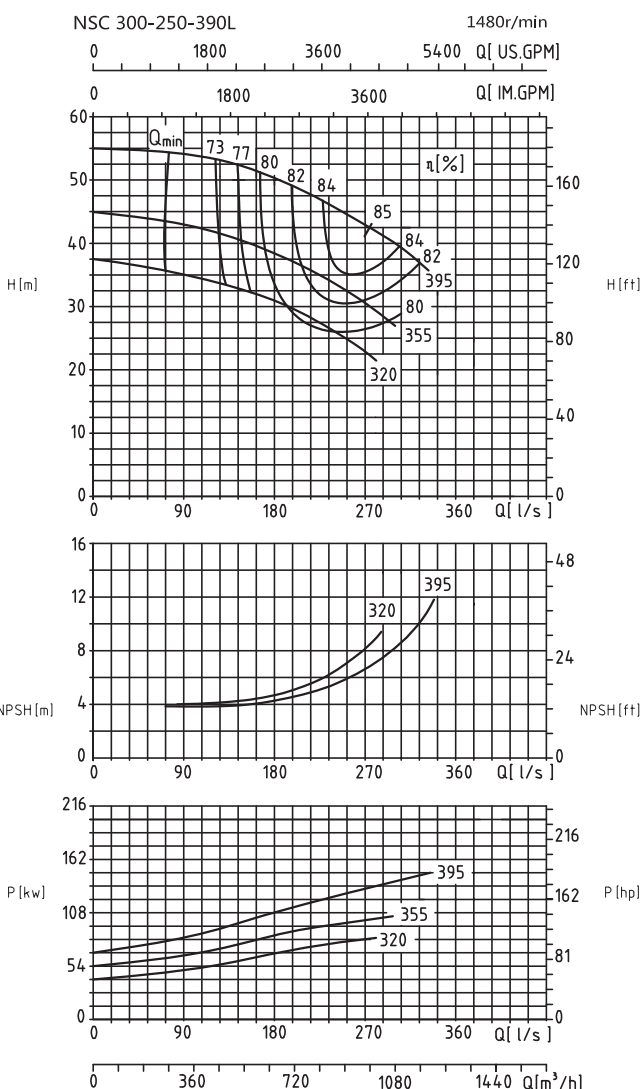
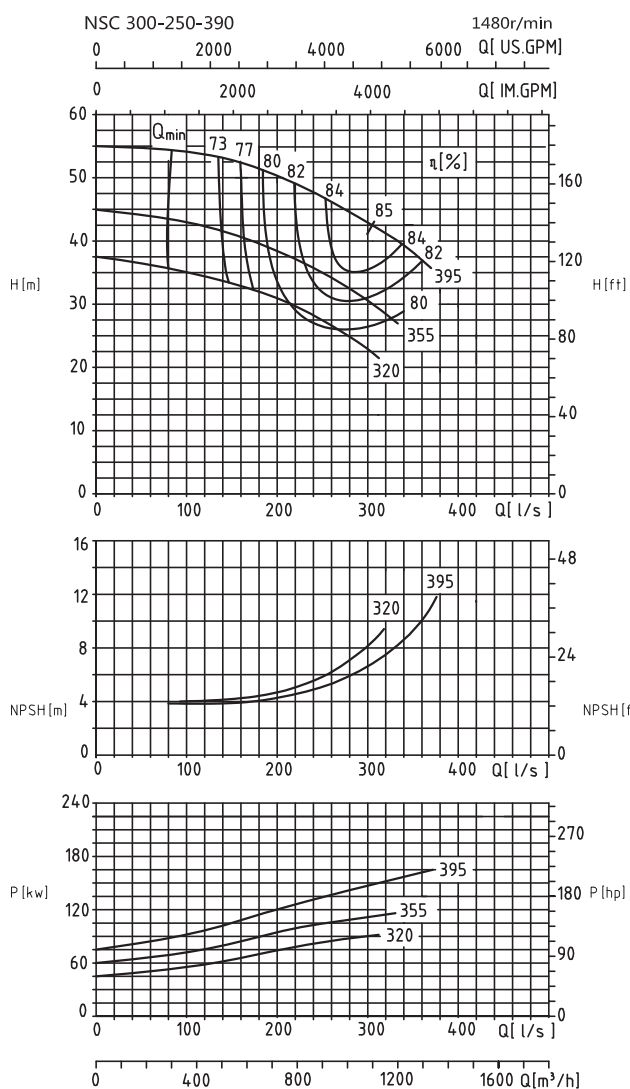

Модель	Производительность		Напор (м)	Скорость (r/min)	Мощность (kw)	Мощность на валу (kw)	КПД (%)	NPSHr (м)	Масса (kg)	
	(m³/h)	(L/s)								
NSC300-250-390	700	194.4	50.5	1480	185	120.4	80	4.0	670	
	1000	277.8	45			144.3	85	6.4		
	1200	333.3	40			155.7	84	8.4		
NSC300-250-390A	700	194.4	38.8		132	92.5	80	4.3		670
	920	255.6	35			107.0	82	5.8		
NSC300-250-390B	1100	305.6	30		110	111.0	81	7.5		670
	600	166.7	32.5			69.0	77	4.2		
	800	222.2	29.5			80.4	80	5.0		
NSC300-250-390L	900	250.0	27.5		160	84.3	80	6.1		670
	630	175.0	50.5	108.4		80	4.0			
	900	250.0	45	129.8		85	6.4			
NSC300-250-390LA	1080	300.0	40	132	140.1	84	8.4	670		
	630	175.0	38.8		83.3	80	4.3			
	828	230.0	35		96.3	82	5.8			
NSC300-250-390LB	990	275.0	30	110	99.9	81	7.5	670		
	540	150.0	32.5		62.1	77	4.2			
	720	200.0	29.5		72.3	80	5.0			
	810	225.0	27.5	2	75.9	80	6.1			

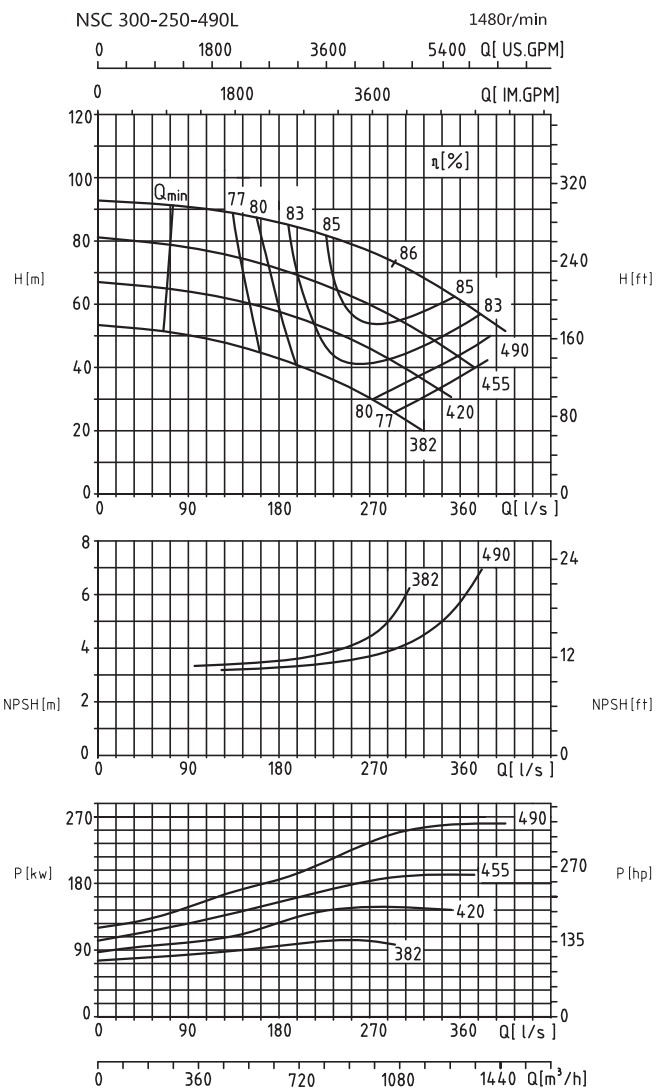
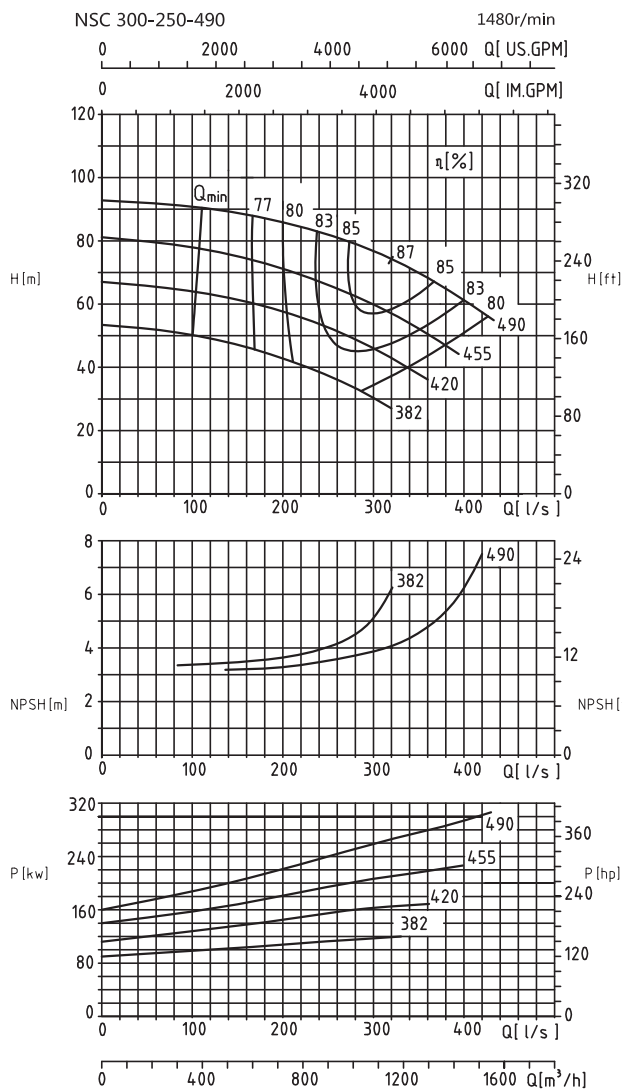

Модель	Производительность		Напор (m)	Скорость (r/min)	Мощность (kw)	Мощность на валу (kw)	КПД (%)	NPSHr (m)	Масса (kg)
	(m ³ /h)	(L/s)							
NSC300-250-490	900	250.0	82	1480	315	239.4	84	3.4	950
	1200	333.3	72			270.6	87	4.0	
	1400	388.9	63			286.1	84	5.7	
NSC300-250-490A	900	250.0	66		250	195.0	83	3.8	
	1100	305.6	59.5			209.8	85	4.6	
	1300	361.1	50			216.0	82	6.0	
NSC300-250-490B	800	222.2	56		200	150.7	81	3.7	
	1000	277.8	49.5			160.6	84	4.3	
	1200	333.3	40.2			162.3	81	5.8	
NSC300-250-490C	800	222.2	40		160	109.0	80	3.8	
	950	263.9	36			115.1	81	4.2	
	1100	305.6	30			118.3	76	5.4	
NSC300-250-490L	810	225.0	82	315	215.5	84	3.4	950	
	1080	300.0	72		243.6	87	4.0		
	1260	350.0	63		257.5	84	5.7		
NSC300-250-490LA	810	225.0	66	220	175.5	83	3.8		
	990	275.0	59.5		188.8	85	4.6		
	1170	325.0	50		194.4	82	6.0		
NSC300-250-490LB	720	200.0	56	185	135.6	81	3.7		
	900	250.0	49.5		144.5	84	4.3		
	1080	300.0	40.2		146.1	81	5.8		
NSC300-250-490LC	720	200.0	40	132	98.1	80	3.8		
	855	237.5	36		103.6	81	4.2		
	990	275.0	30		106.5	76	5.4		

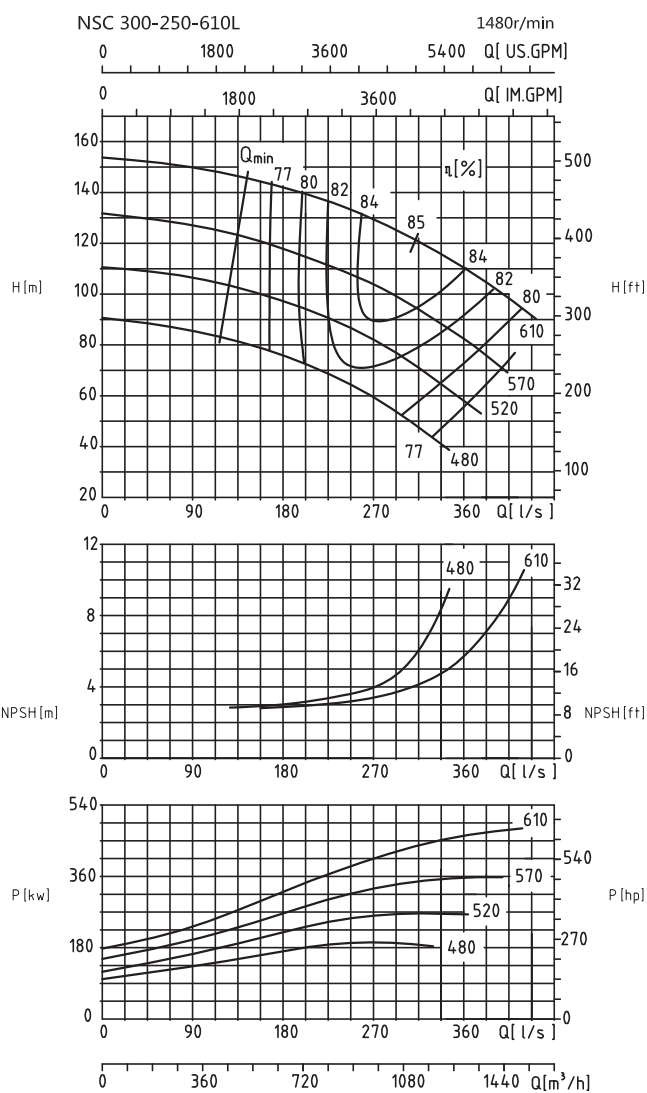
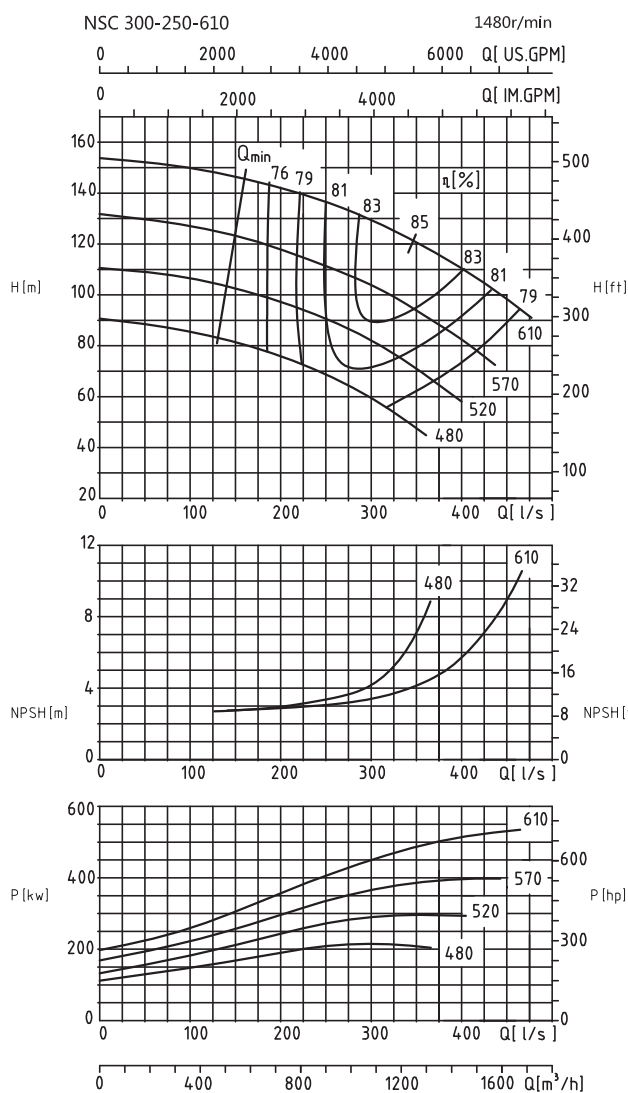

Модель	Производительность		Напор (m)	Скорость (r/min)	Мощность (kw)	Мощность на валу (kw)	КПД (%)	NPSHг (m)	Масса (kg)
	(m³/h)	(L/s)							
NSC300-250-610	1000	277.8	132	1480	560	438.7	82	3.1	1180
	1250	347.2	121			484.9	85	3.9	
	1400	388.9	112			514.8	83	5.2	
NSC300-250-610A	900	250.0	111		450	336.1	81	3.2	
	1150	319.4	102			385.1	83	3.9	
	1300	361.1	91			393.1	82	5.9	
NSC300-250-610B	900	250.0	90		355	272.5	81	3.2	
	1050	291.7	84			293.1	82	3.8	
	1200	333.3	75			302.8	81	5.1	
NSC300-250-610C	800	222.2	73		280	201.4	79	3.2	
	1000	277.8	64			218.0	80	3.7	
	1200	333.3	52			218.0	78	5.8	
NSC300-250-610L	900	250.0	132	560	394.8	82	3.1		
	1125	312.5	121		436.4	85	3.9		
	1260	350.0	112		463.3	83	5.2		
NSC300-250-610LA	810	225.0	111	400	302.5	81	3.2		
	1035	287.5	102		346.6	83	3.9		
	1170	325.0	91		353.8	82	5.9		
NSC300-250-610LB	810	225.0	90	315	245.3	81	3.2		
	945	262.5	84		263.8	82	3.8		
	1080	300.0	75		272.5	81	5.1		
NSC300-250-610LC	720	200.0	73	220	181.3	79	3.2		
	900	250.0	64		196.2	80	3.7		
	1080	300.0	52		196.2	78	5.8		

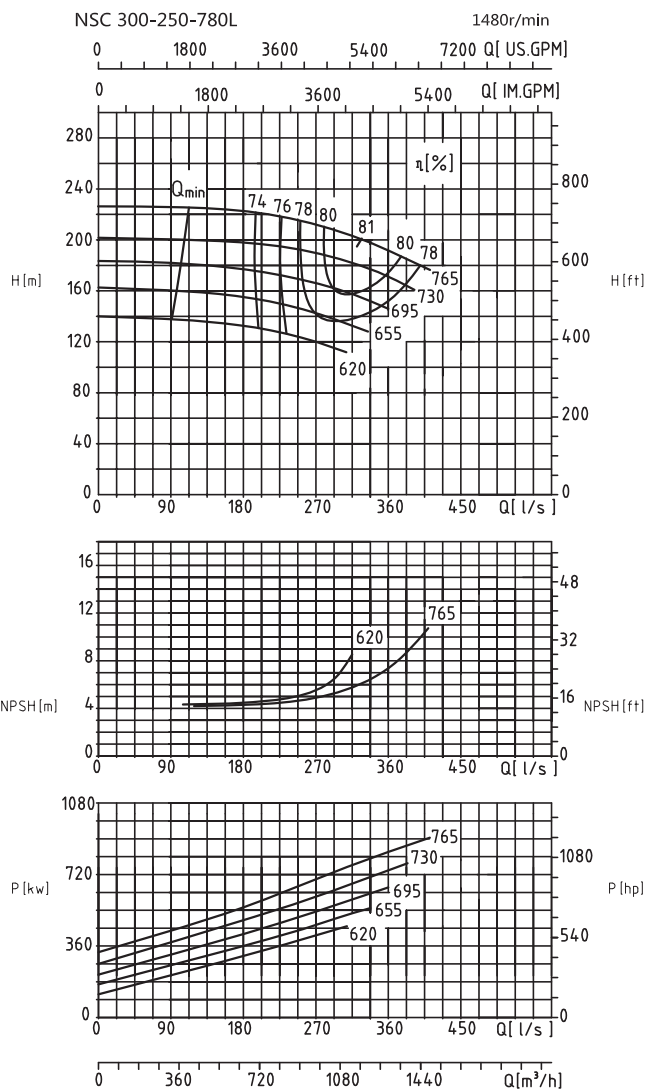
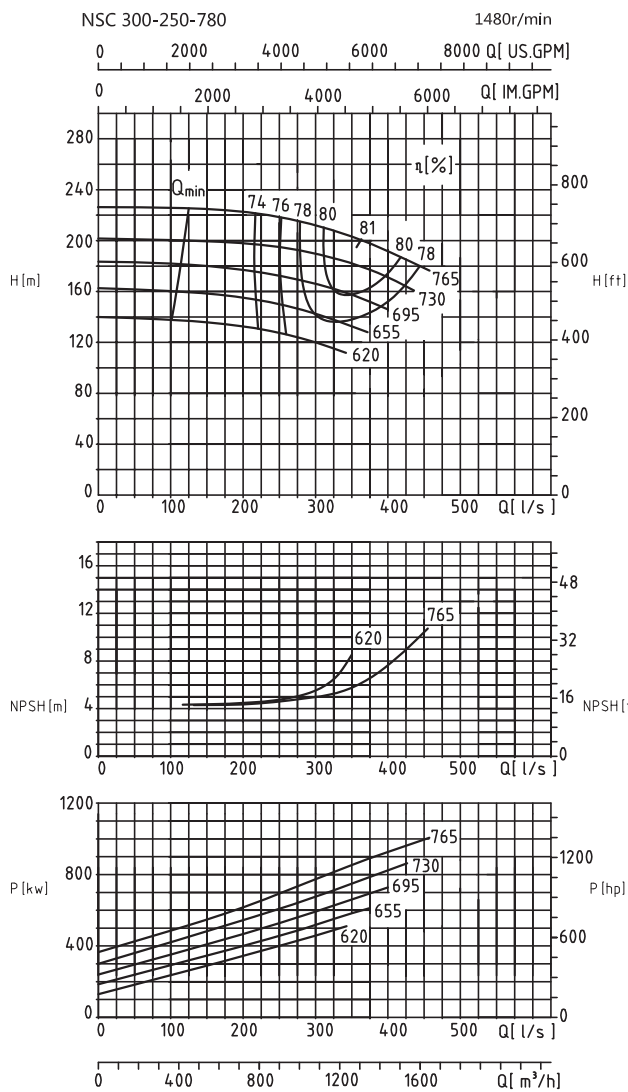

Модель	Производительность		Напор (m)	Скорость (r/min)	Мощность (kw)	Мощность на валу (kw)	КПД (%)	NPSHr (m)	Масса (kg)	
	(m³/h)	(L/s)								
NSC300-250-780	1000	277.8	215	1480	1120	751.1	78	4.6	1700	
	1200	333.3	207			846.1	80	5.3		
	1400	388.9	194			925.1	80	6.9		
NSC300-250-780A	1000	277.8	192		900	800	670.8	78		4.9
	1200	333.3	185				756.2	80		5.8
	1300	361.1	180				797.1	80		6.7
NSC300-250-780B	900	250.0	171		800	800	566.7	74		4.7
	1100	305.6	165				634.1	78		5.5
	1300	361.1	153				677.5	80		7.2
NSC300-250-780C	900	250.0	147		710	710	480.7	75		4.8
	1050	291.7	141				523.9	77		5.4
	1200	333.3	133				572.3	76		6.7
NSC300-250-780D	900	250.0	124	560	560	405.5	75	4.7		
	1000	277.8	122			437.4	76	5.1		
	1100	305.6	119.5			465.2	77	5.7		
NSC300-250-780L	900	250.0	215	1480	1000	676.0	78	4.6	1700	
	1080	300.0	207			761.5	80	5.3		
	1260	350.0	194			832.6	80	6.9		
NSC300-250-780LA	900	250.0	192		800	800	603.7	78		4.9
	1080	300.0	185				680.6	80		5.8
	1170	325.0	180				717.4	80		6.7
NSC300-250-780LB	810	225.0	171		710	710	510.1	74		4.7
	990	275.0	165				570.7	78		5.5
	1170	325.0	153				609.8	80		7.2
NSC300-250-780LC	810	225.0	147		630	630	432.6	75		4.8
	945	262.5	141				471.5	77		5.4
	1080	300.0	133				515.0	76		6.7
NSC300-250-780LD	810	225.0	124	500	500	364.9	75	4.7		
	900	250.0	122			393.7	76	5.1		
	990	275.0	119.5			418.7	77	5.7		

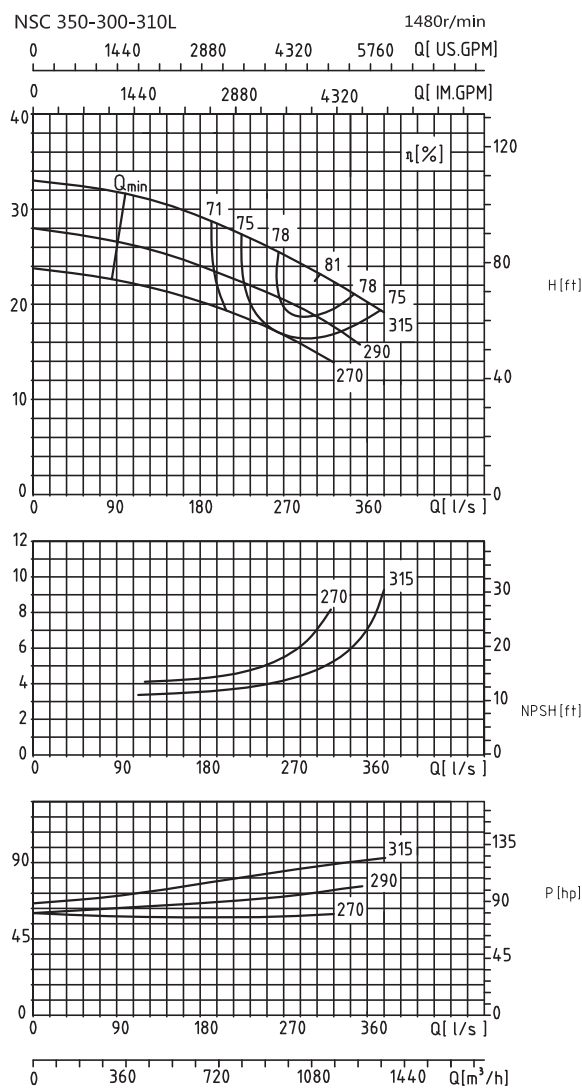
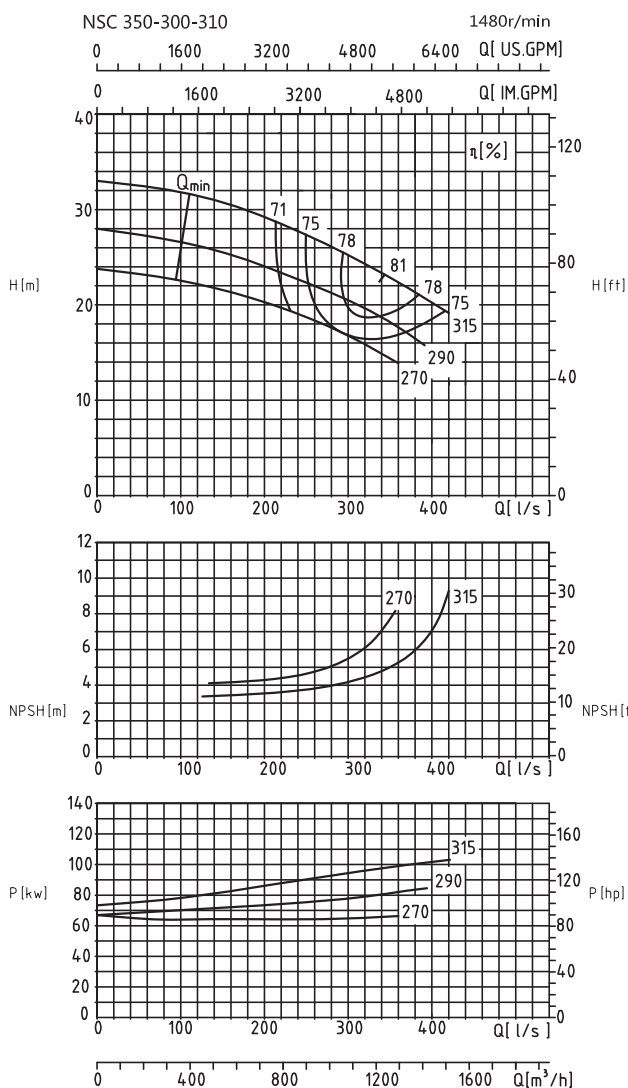

Модель	Производительность		Напор (м)	Скорость (r/min)	Мощность (kw)	Мощность на валу (kw)	КПД (%)	NPSHr (m)	Масса (kg)	
	(m³/h)	(L/s)								
NSC350-300-310	900	250.0	27.4	1480	110	89.6	75	3.8	800	
	1100	305.6	25			96.1	78	4.3		
	1300	361.1	22.2			99.5	79	5.4		
NSC350-300-310A	900	250.0	22.2		90	72.6	75	4.2		800
	1050	291.7	20.8			77.3	77	4.5		
	1200	333.3	19			79.7	78	5.8		
NSC350-300-310B	800	222.2	19.7		75	61.4	70	4.3		800
	950	263.9	18.1			64.2	73	4.8		
	1100	305.6	16.5			65.9	75	5.5		
NSC350-300-310L	810	225.0	27.4	110	80.6	75	3.8	800		
	990	275.0	25		86.5	78	4.3			
	1170	325.0	22.2		89.6	79	5.4			
NSC350-300-310LA	810	225.0	22.2	90	65.3	75	4.2		800	
	945	262.5	20.8		69.6	77	4.5			
	1080	300.0	19		71.7	78	5.8			
NSC350-300-310LB	720	200.0	19.7	75	55.2	70	4.3		800	
	855	237.5	18.1		57.8	73	4.8			
	990	275.0	16.5		² 59.4	75	5.5			

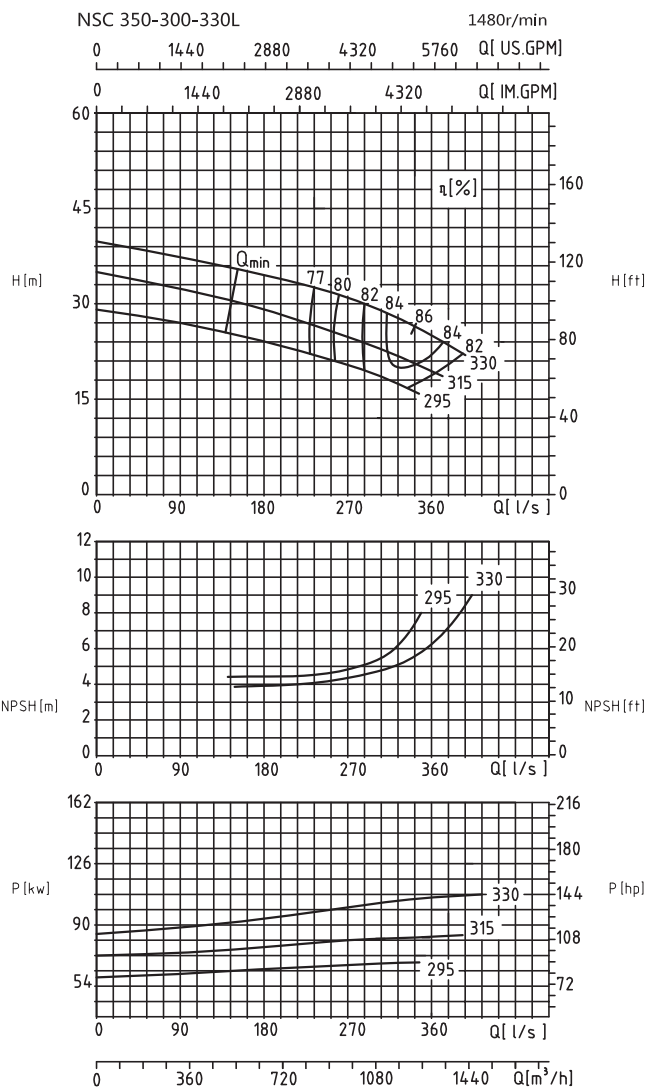
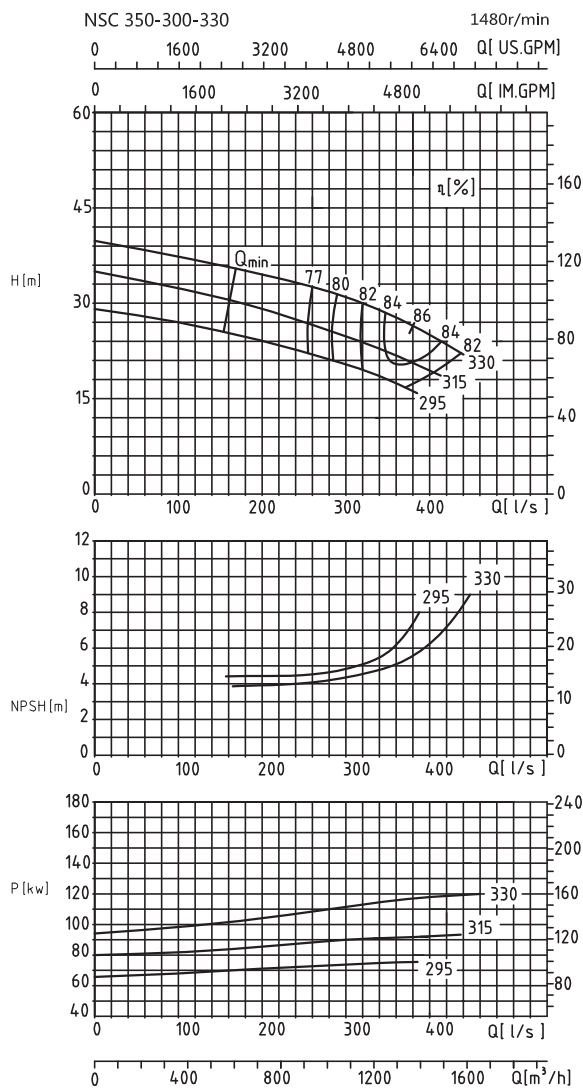

Модель	Производительность		Напор (m)	Скорость (r/min)	Мощность (kw)	Мощность на валу (kw)	КПД (%)	NPSHr (m)	Масса (kg)
	(m³/h)	(L/s)							
NSC350-300-330	1100	305.6	30.5	1480	160	122.9	81	4.4	800
	1300	361.1	27.8			115.9	85	5.1	
	1500	416.7	23.8			117.2	83	7.0	
NSC350-300-330A	1000	277.8	25.8		132	89.0	79	4.5	
	1200	333.3	23.3			91.8	83	5.0	
	1400	388.9	20.2			92.8	83	6.5	
NSC350-300-330B	1000	277.8	21.1		110	72.8	79	4.7	
	1150	319.4	19.5			74.5	82	5.1	
	1300	361.1	17.4			75.2	82	6.2	
NSC350-300-330L	990	275.0	30.5	160	119.9	81	4.4	800	
	1170	325.0	27.8		123.8	85	5.1		
	1350	375.0	23.8		130.3	83	5.9		
NSC350-300-330LA	900	250.0	25.8	132	92.6	81	4.7		
	1080	300.0	23.3		97.8	84	5.3		
	1260	350.0	24		99.3	83	6.7		
NSC350-300-330LB	900	250.0	24	110	74.5	79	4.7		
	1080	300.0	21		75.4	82	5.3		
	1170	325.0	19.3		² 76.0	81	6.2		

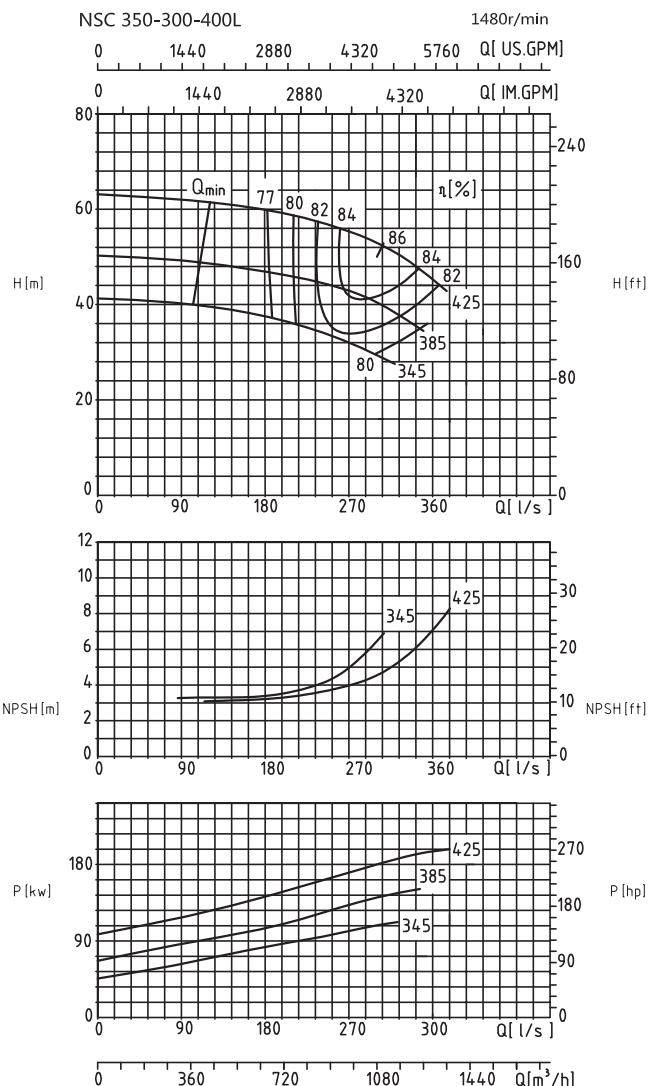
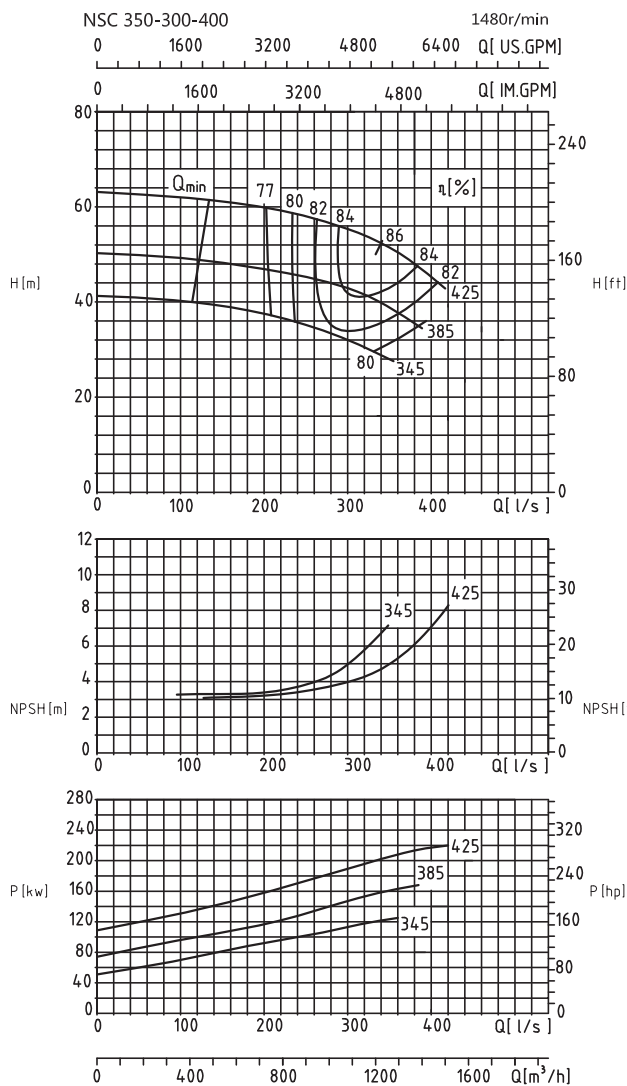

Модель	Производительность		Напор (m)	Скорость (r/min)	Мощность (kw)	Мощность на валу (kw)	КПД (%)	NPSHr (m)	Масса (kg)	
	(m³/h)	(L/s)								
NSC350-300-400	1000	277.8	58.5	1480	250	192.1	83	3.7	900	
	1250	347.2	52			206.0	86	5.0		
	1400	388.9	47			216.0	83	6.5		
NSC350-300-400A	1000	277.8	44		185	144.5	83	4.0		
	1150	319.4	41.5			154.8	84	5.0		
	1300	361.1	37.5			162.0	82	6.3		
NSC350-300-400B	900	250.0	35		160	107.3	80	3.8		
	1050	291.7	32.5			114.8	81	4.7		
	1200	333.3	29.4			120.2	80	6.4		
NSC350-300-400L	900	250.0	58.5		220	172.9	83	3.7		900
	1125	312.5	52			185.4	86	5.0		
	1260	350.0	47			194.4	83	6.5		
NSC350-300-400LA	900	250.0	44	185	130.0	83	4.0			
	1035	287.5	41.5		139.3	84	5.0			
	1170	325.0	37.5		145.8	82	6.3			
NSC350-300-400LB	810	225.0	35	132	96.6	80	3.8			
	945	262.5	32.5		103.3	81	4.7			
	1080	300.0	29.4		² 108.2	80	6.4			

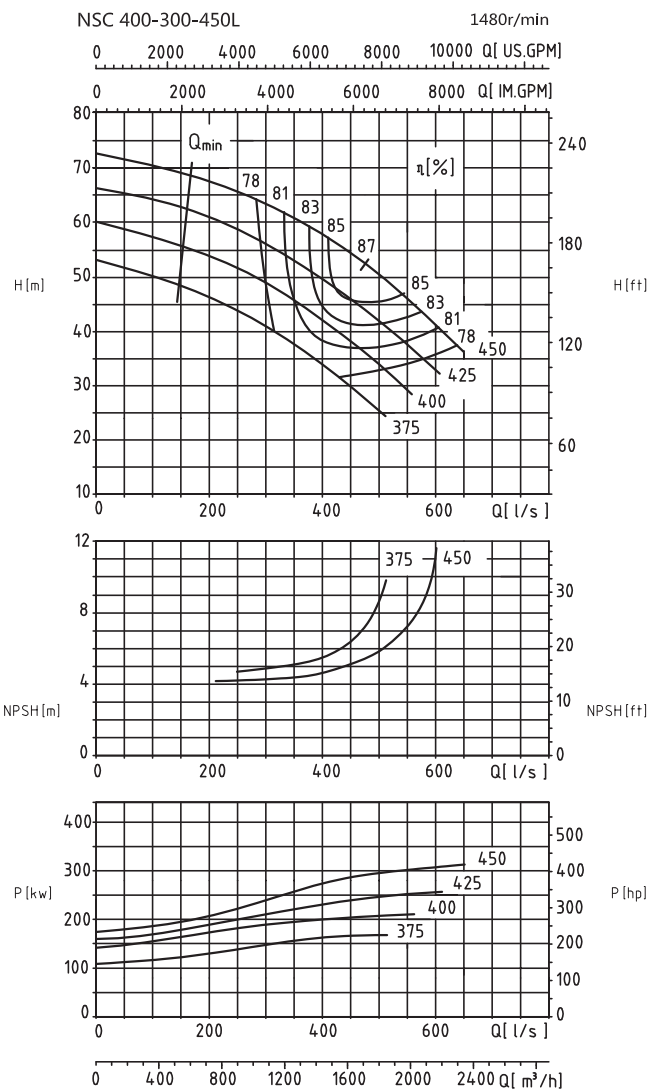
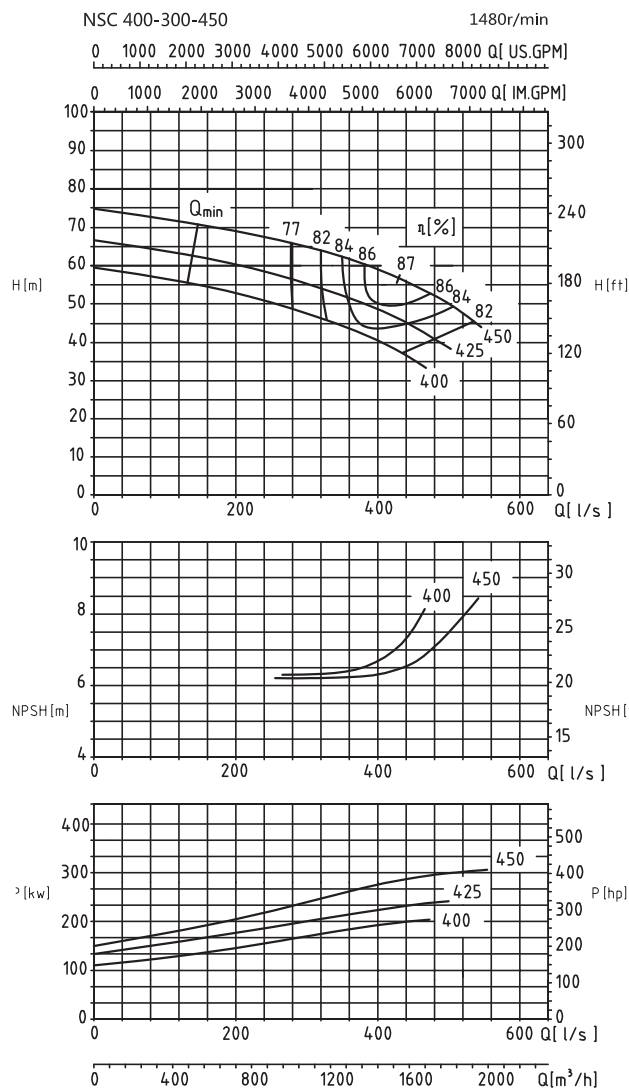

Модель	Производительность		Напор (м)	Скорость (r/min)	Мощность (kw)	Мощность на валу (kw)	КПД (%)	NPSH _r (м)	Масса (kg)
	(m³/h)	(L/s)							
NSC400-300-450H	1200	333.3	63	1480	355	248.2	83	6.2	1000
	1520	422.2	57			271.4	87	6.4	
	1760	488.9	51.2			288.9	85	7.3	
NSC400-300-450HA	1200	333.3	53		280	208.8	83	6.2	
	1450	402.8	49			227.8	85	6.6	
	1680	466.7	42.5			234.4	83	7.3	
NSC400-300-450HB	1200	333.3	45.5		220	181.4	82	6.3	
	1360	377.8	42.5			189.8	83	6.5	
	1520	422.2	39			197.0	82	7.0	
NSC400-300-450L	1260	350.0	58.5	1480	315	242.0	83	4.6	1000
	1530	425.0	52.5			254.5	86	5.5	
	1800	500.0	45.6			266.3	84	7.5	
NSC400-300-450LA	1170	325.0	52.5		280	204.1	82	4.8	
	1440	400.0	46			212.4	85	5.5	
	1710	475.0	39.6			225.0	82	8.0	
NSC400-300-450LB	1170	325.0	47		220	185.0	81	4.9	
	1350	375.0	41			183.9	82	5.2	
	1530	425.0	34			175.0	81	6.4	
NSC400-300-450LC	1080	300.0	38.8	185	146.4	78	5.0		
	1260	350.0	35		150.2	80	5.4		
	1440	400.0	30		² 152.9	77	6.3		

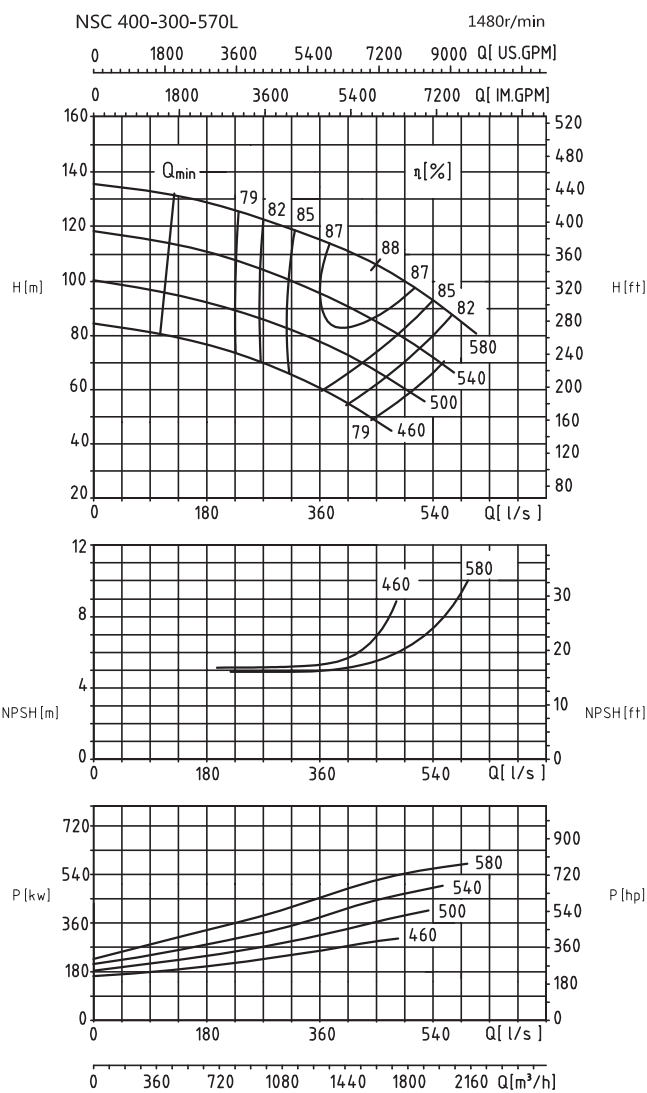
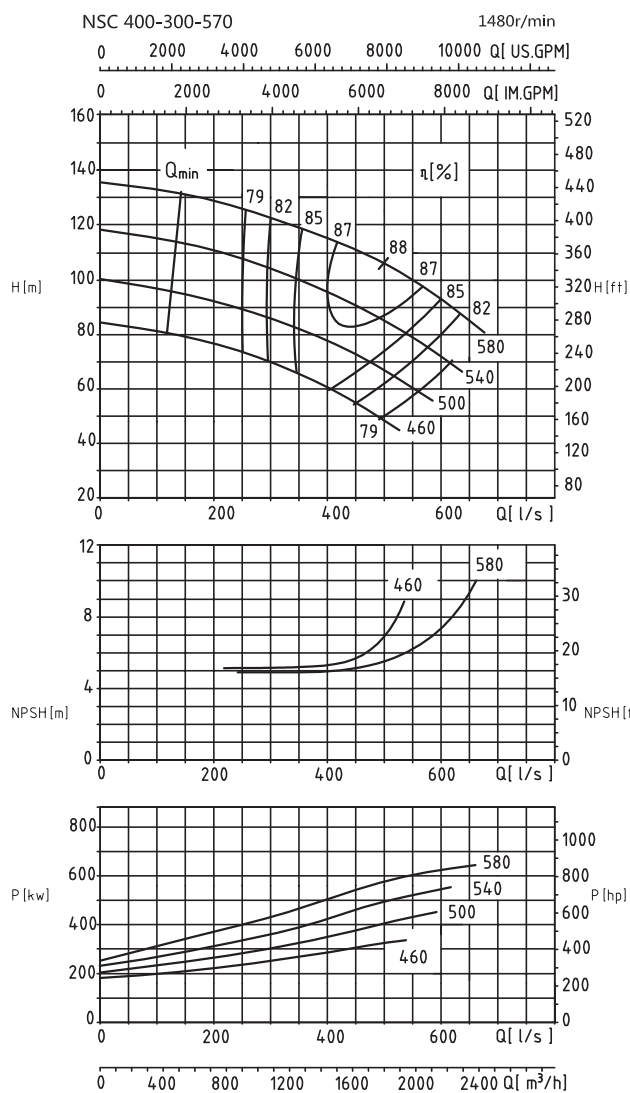

Модель	Производительность		Напор (m)	Скорость (r/min)	Мощность (kw)	Мощность на валу (kw)	КПД (%)	NPSHr (m)	Масса (kg)
	(m³/h)	(L/s)							
NSC400-300-570	1500	416.7	113	1480	710	530.9	87	5.0	1480
	1800	500.0	105.5			588.0	88	5.5	
	2000	555.6	99			634.8	85	6.3	
NSC400-300-570A	1400	388.9	97		560	430.3	86	5.1	
	1600	444.4	91.5			458.6	87	5.4	
	1900	527.8	82			499.5	85	6.9	
NSC400-300-570B	1300	361.1	81		450	337.6	85	5.1	
	1500	416.7	77			366.0	86	5.3	
	1800	500.0	67			395.9	83	6.4	
NSC400-300-570C	1200	333.3	67.5		355	262.8	84	5.2	
	1400	388.9	62			278.3	85	5.4	
	1700	472.2	51			295.3	80	6.1	
NSC400-300-570L	1350	375.0	113	1480	710	477.8	87	5.0	1480
	1620	450.0	105.5			529.2	88	5.5	
	1800	500.0	99			571.3	85	6.3	
NSC400-300-570LA	1260	350.0	97		560	387.3	86	5.1	
	1440	400.0	91.5			412.7	87	5.4	
	1710	475.0	82			449.5	85	6.9	
NSC400-300-570LB	1170	325.0	81		450	303.8	85	5.1	
	1350	375.0	77			329.4	86	5.3	
	1620	450.0	67			356.4	83	6.4	
NSC400-300-570LC	1080	300.0	67.5		315	236.5	84	5.2	
	1260	350.0	62			250.4	85	5.4	
	1530	425.0	51			265.8	80	6.1	

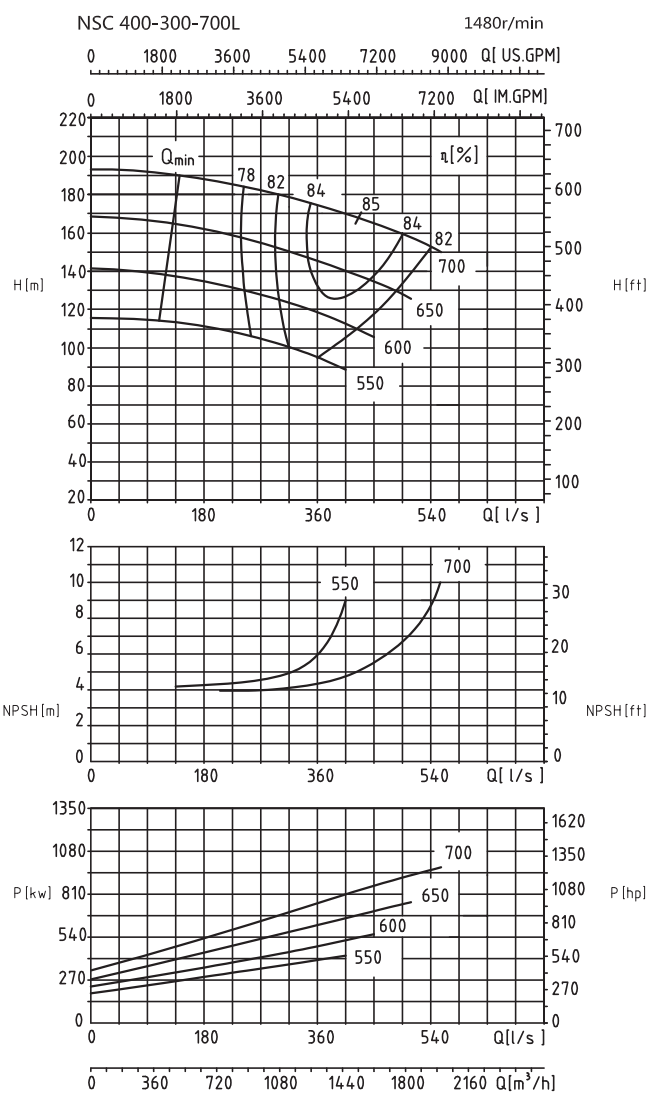
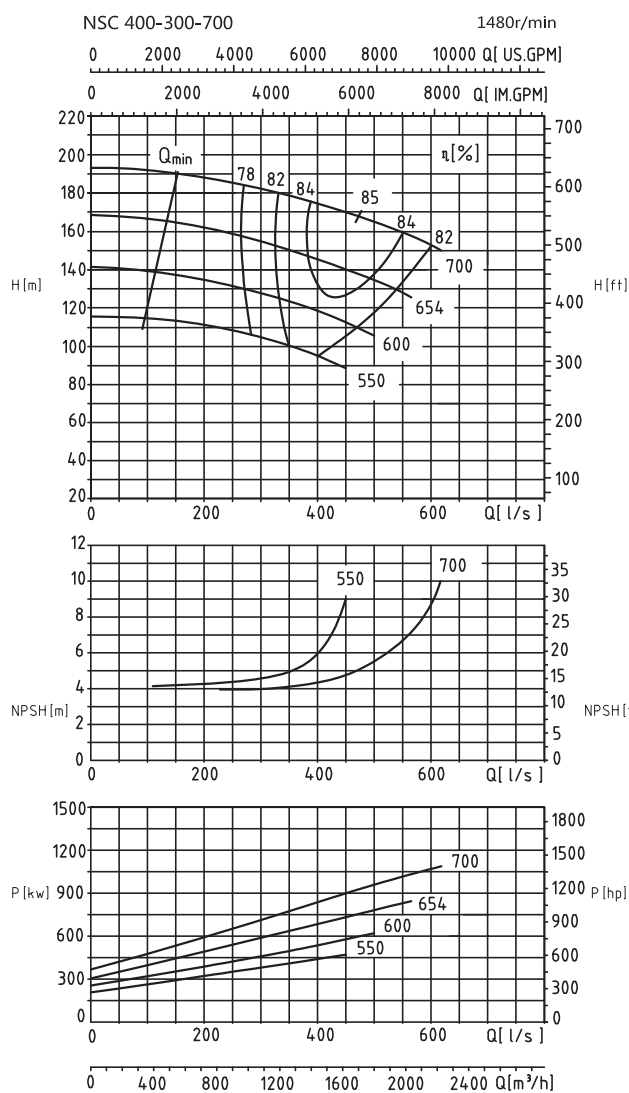

Модель	Производительность		Напор (m)	Скорость (r/min)	Мощность (kw)	Мощность на валу (kw)	КПД (%)	NPSHr (m)	Масса (kg)
	(m ³ /h)	(l/s)							
NSC400-300-700	1400	388.9	175	1480	1120	794.8	84	4.3	1650
	1700	472.2	167			910.2	85	5.2	
	1900	527.8	162			998.5	84	6.2	
NSC400-300-700A	1300	361.1	150		1000	640.2	83	4.5	
	1600	444.4	140.5			729.3	84	5.6	
	1800	500.0	134.5			794.8	83	7.1	
NSC400-300-700B	1200	333.3	125		800	498.5	82	4.6	
	1500	416.7	117.5			578.7	83	5.6	
	1700	472.2	110			621.4	82	7.4	
NSC400-300-700C	1100	305.6	104.5		560	396.5	79	4.6	
	1300	361.1	100			432.0	82	5.0	
	1500	416.7	93			475.2	80	6.7	
NSC400-300-700L	1260	350.0	175	1000	715.3	84	4.3		
	1530	425.0	167		819.1	85	5.2		
	1710	475.0	162		898.7	84	6.2		
NSC400-300-700LA	1170	325.0	150	900	576.2	83	4.5		
	1440	400.0	140.5		656.3	84	5.6		
	1620	450.0	134.5		715.4	83	7.1		
NSC400-300-700LB	1080	300.0	125	710	448.6	82	4.6		
	1350	375.0	117.5		520.8	83	5.6		
	1530	425.0	110		559.3	82	7.4		
NSC400-300-700LC	990	275.0	104.5	560	356.9	79	4.6		
	1170	325.0	100		388.8	82	5.0		
	1350	375.0	93		427.7	80	6.7		

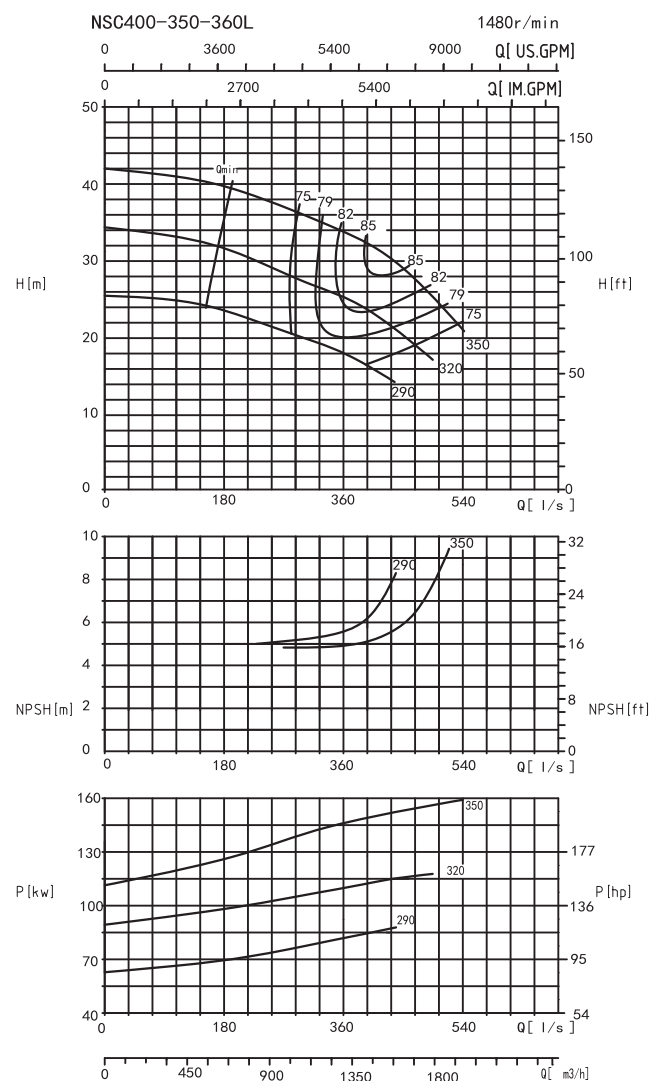
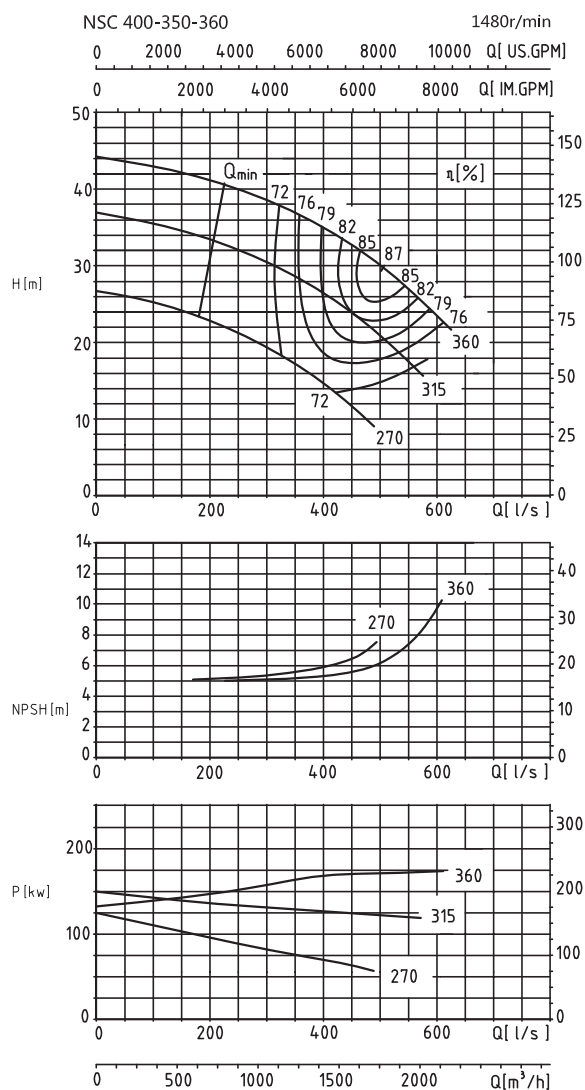

Модель	Производительность		Напор (м)	Скорость (r/min)	Мощность (kw)	Мощность на валу (kw)	КПД (%)	NPSHr (м)	Масса (kg)
	(м³/ч)	(L/s)							
NSC400-350-360	1500	416.7	33.8	1480	200	168.5	82	5.3	910
	1800	500.0	30			173.1	85	6.5	
	2000	555.6	25.8			171.5	82	8.3	
NSC400-350-360A	1375	381.9	27		160	129.7	78	5.6	
	1650	458.3	23.5			128.9	82	6.2	
	1750	486.1	21			126.8	79	7.2	
NSC400-350-360B	1125	312.5	18.6		132	79.2	72	5.5	
	1375	381.9	15.1			76.5	74	6.0	
	1500	416.7	13.4			76.1	72	6.3	
NSC400-350-360L	1280	355.6	34	185	144.6	82	5.0		
	1570	436.1	30		150.1	85.5	5.5		
	1800	500.0	25.5		154.4	81	8.0		
NSC400-350-360LA	1140	316.7	26.5	132	104.2	79	5.6		
	1420	394.4	24		113.3	82	6.2		
	1600	444.4	21		115.9	79	7.2		
NSC400-350-360LB	1020	283.3	20.5	110	76.0	75	5.2		
	1240	344.4	18.5		80.1	78	³ 5.5		
	1450	402.8	16.5		² 86.9	75	6.3		

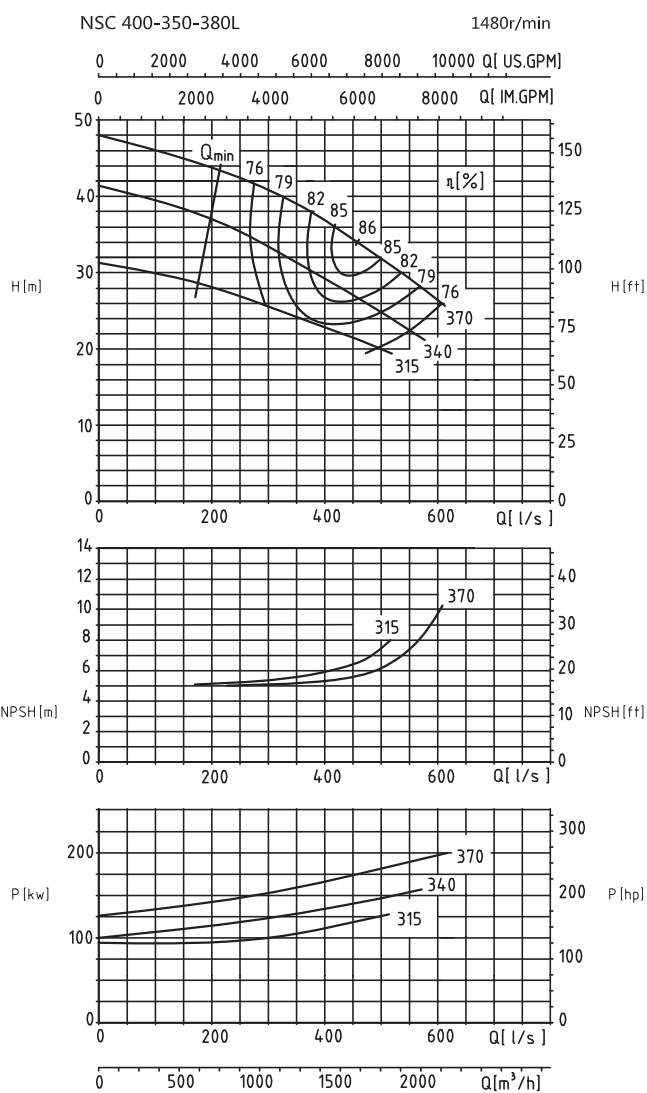
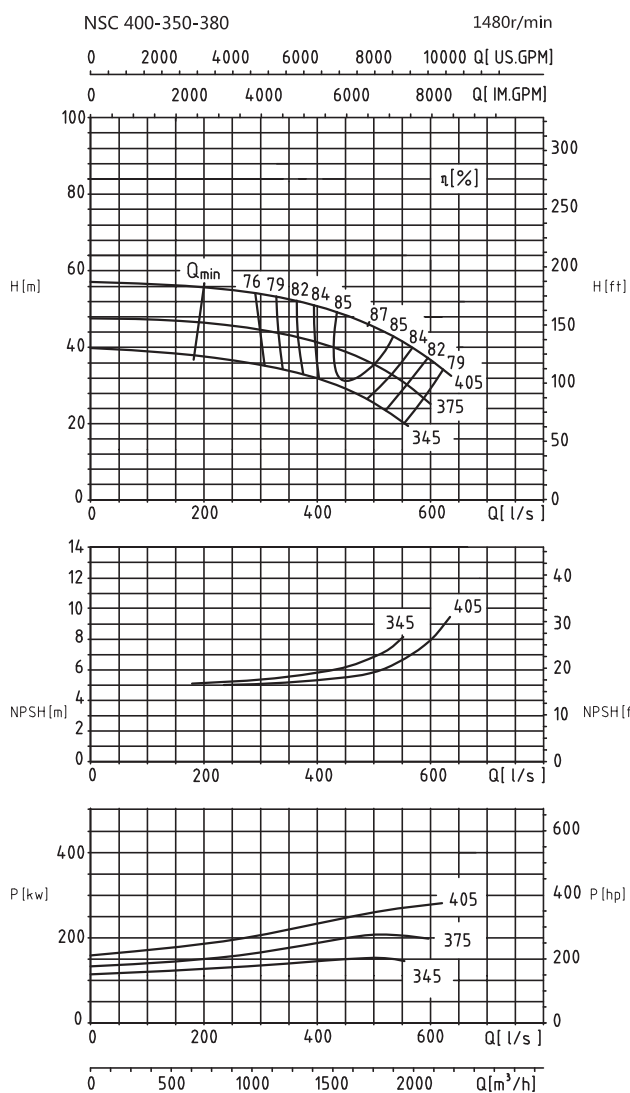

Модель	Производительность		Напор (м)	Скорость (r/min)	Мощность (kw)	Мощность на валу (kw)	КПД (%)	NPSHr (м)	Масса (kg)
	(m³/h)	(L/s)							
NSC400-350-380	1375	381.9	51	1480	315	230.2	83	5.3	910
	1700	472.2	46.1			245.5	87	5.8	
	2000	555.6	39.9			258.9	84	7.2	
NSC400-350-380A	1375	381.9	41.5		220	187.3	83	5.5	
	1625	451.4	38			198.0	85	6.0	
	1875	520.8	32.4			199.5	83	6.9	
NSC400-350-380B	1250	347.2	33.7		185	143.5	80	5.6	
	1500	416.7	30.3			147.4	84	6.0	
	1750	486.1	25.6			147.1	83	6.9	
NSC400-350-380L	1300	361.1	38	220	164.2	82	5.2		
	1600	444.4	34		172.4	86	5.7		
	1875	520.8	30		186.9	82	7.0		
NSC400-350-380LA	1250	347.2	31.2	185	131.2	81	5.4		
	1500	416.7	28		137.9	83	5.9		
	1750	486.1	25		150.9	79	6.9		
NSC400-350-380LB	1125	312.5	25	160	100.8	76	5.5		
	1350	375.0	23.3		109.9	78	5.9		
	1600	444.4	21.5		² 123.3	76	6.4		

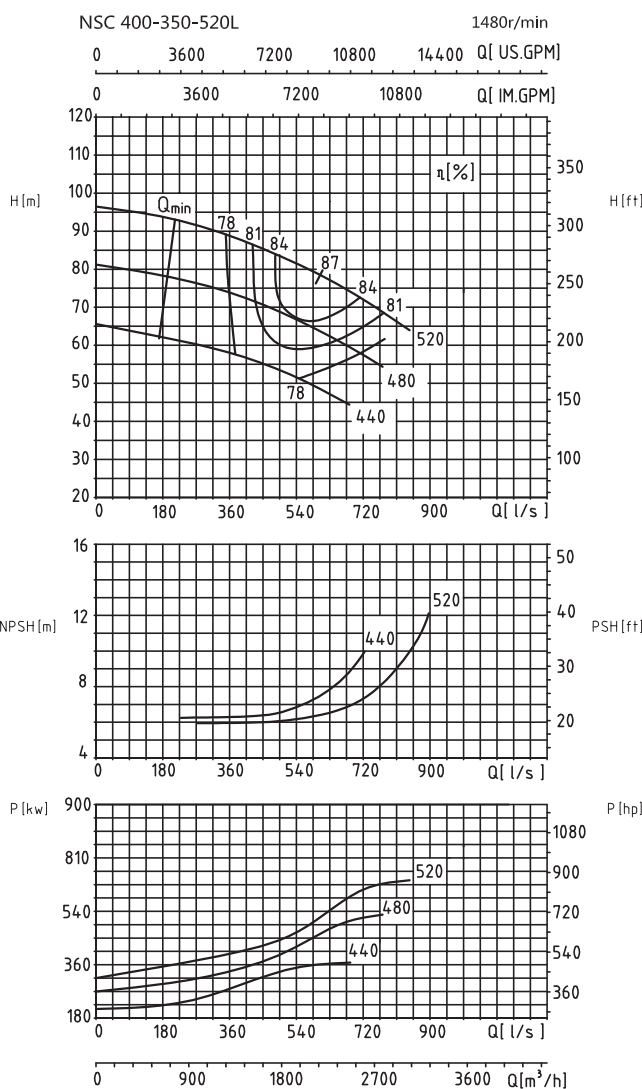
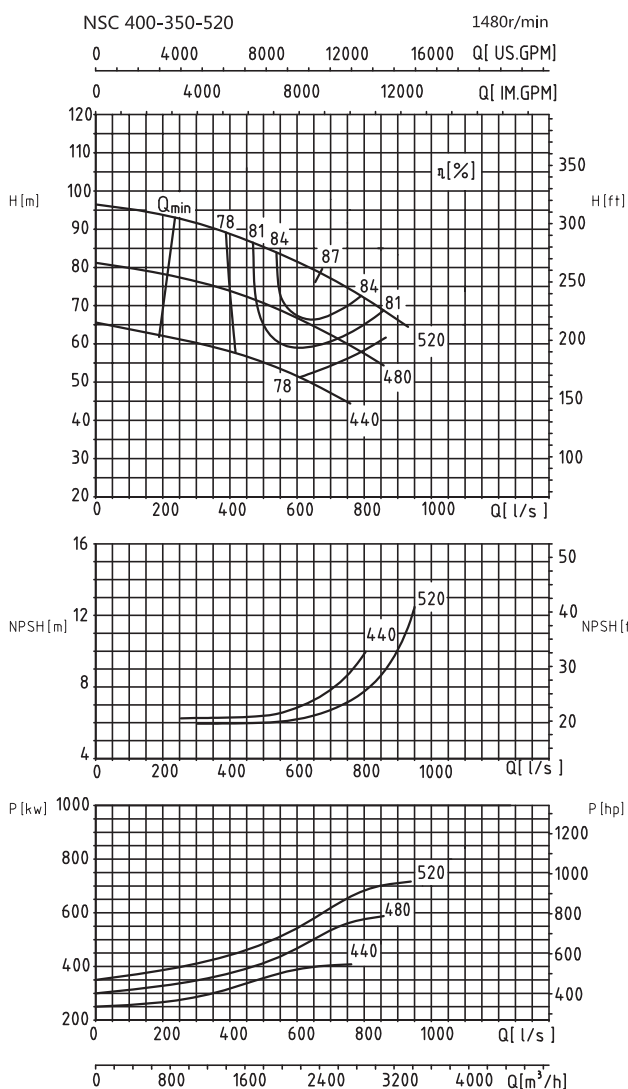

Модель	Производительность		Напор (м)	Скорость (r/min)	Мощность (kw)	Мощность на валу (kw)	КПД (%)	NPSHr (m)	Масса (kg)
	(m³/h)	(L/s)							
NSC400-350-520	2000	555.6	83	1480	800	532.2	85	6.3	1350
	2400	666.7	78.5			590.1	87	6.8	
	2800	777.8	73.5			659.8	85	8.2	
NSC400-350-520A	1800	500.0	83		630	426.9	81	6.3	
	2400	666.7	70.5			478.9	83	6.8	
	2600	722.2	61.5			537.9	81	7.8	
NSC400-350-520B	1600	444.4	56.6		450	316.4	78	6.4	
	1900	527.8	54.2			355.2	79	6.5	
	2200	611.1	51			397.1	77	7.0	
NSC400-350-520L	1800	500.0	83	710	479.0	85	6.3		
	2160	600.0	78.5		531.1	87	6.8		
	2520	700.0	73.5		593.8	85	8.2		
NSC400-350-520LA	1620	450.0	70.5	560	384.2	81	6.3		
	1980	550.0	66.3		431.0	83	6.8		
	2340	650.0	61.5		484.1	81	7.8		
NSC400-350-520LB	1440	400.0	56.6	450	284.7	78	6.4		
	1710	475.0	54.2		319.7	79	6.5		
	1980	550.0	51		357.4	77	7.0		

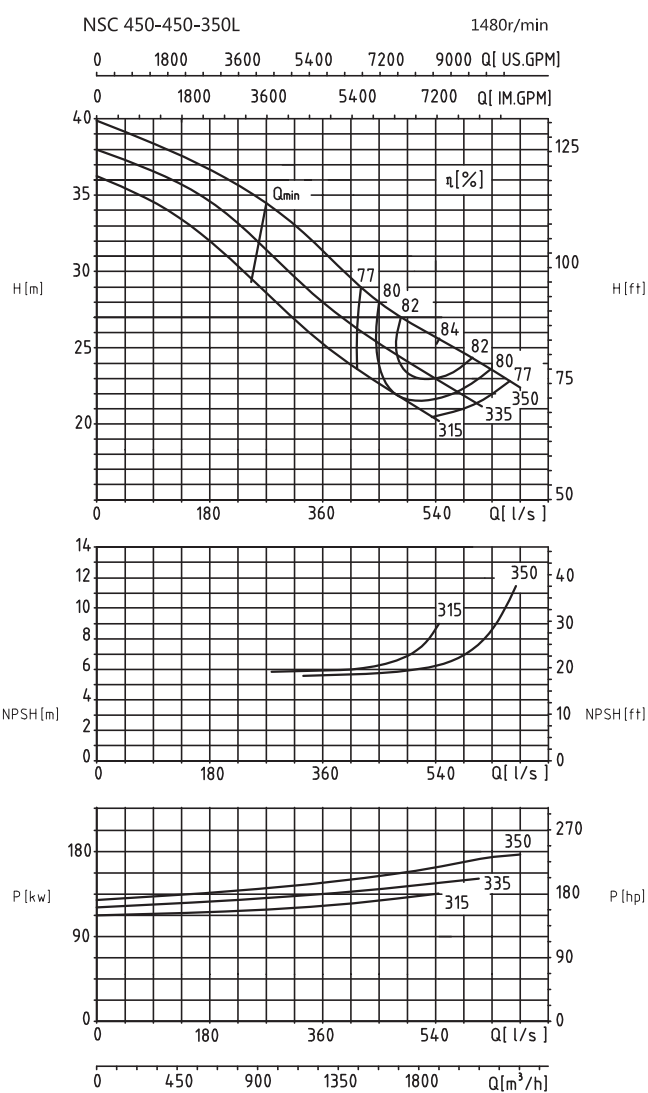
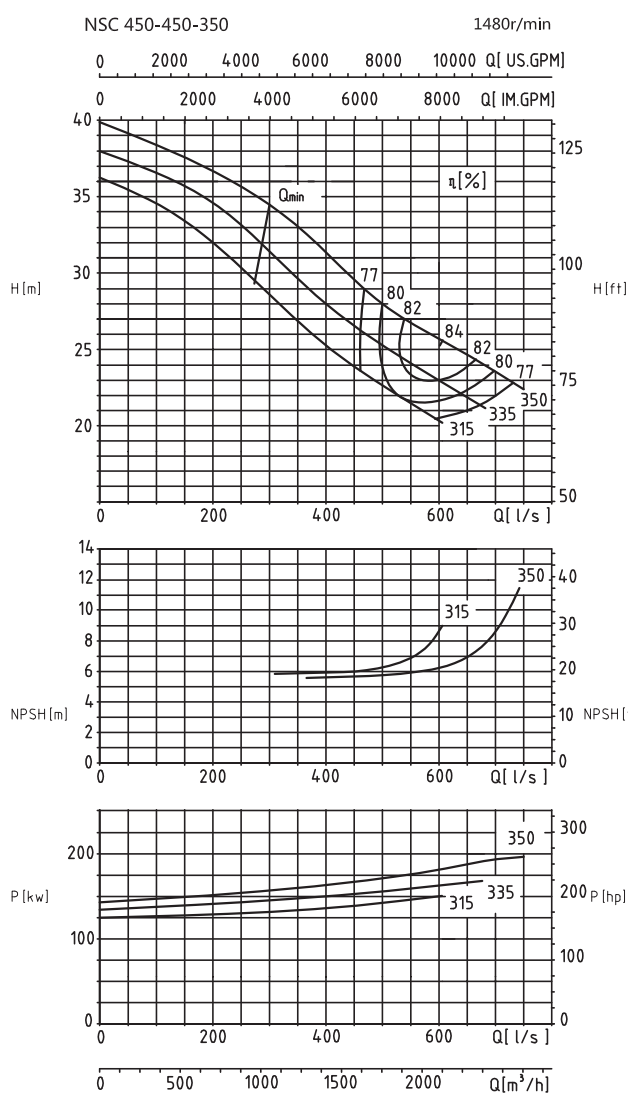

Модель	Производительность		Напор (м)	Скорость (r/min)	Мощность (kw)	Мощность на валу (kw)	КПД (%)	NPSHr (м)	Масса (kg)
	(m ³ /h)	(L/s)							
NSC450-450-350	1900	527.8	27	1480	220	170.5	82	5.9	1000
	2200	611.1	25			180.6	83	6.5	
	2400	666.7	24			193.8	81	8.0	
NSC450-450-350A	1750	486.1	25.2		200	152.1	79	6.0	
	2000	555.6	23.7			157.5	82	6.6	
	2250	625.0	22			170.7	79	8.6	
NSC450-450-350B	1750	486.1	23.2		185	140.0	79	6.2	
	1900	527.8	21.7			142.2	79	6.8	
	2100	583.3	20.3			150.9	77	8.5	
NSC450-450-350L	1710	475.0	27	220	153.4	82	5.9		
	1980	550.0	25		162.5	83	6.5		
	2160	600.0	24		174.4	81	8.0		
NSC450-450-350LA	1575	437.5	25.2	185	136.9	79	6.0		
	1800	500.0	23.7		141.8	82	6.6		
	2025	562.5	22		153.7	79	8.6		
NSC450-450-350LB	1575	437.5	23.2	160	126.0	79	6.2		
	1710	475.0	21.7		128.0	79	6.8		
	1890	525.0	20.3		135.8	77	8.5		

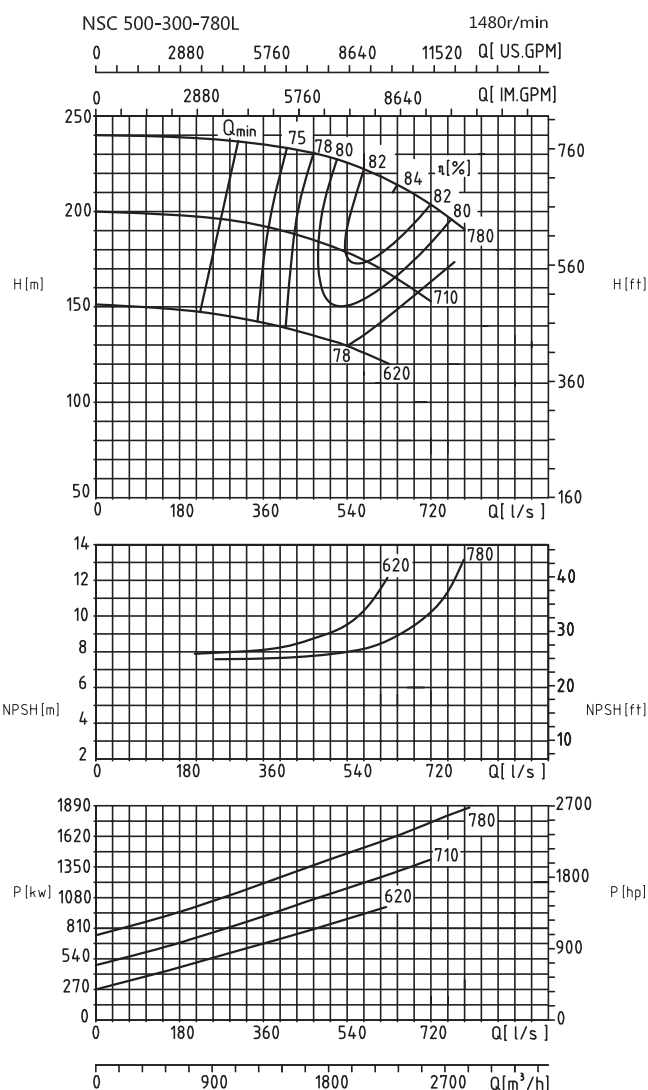
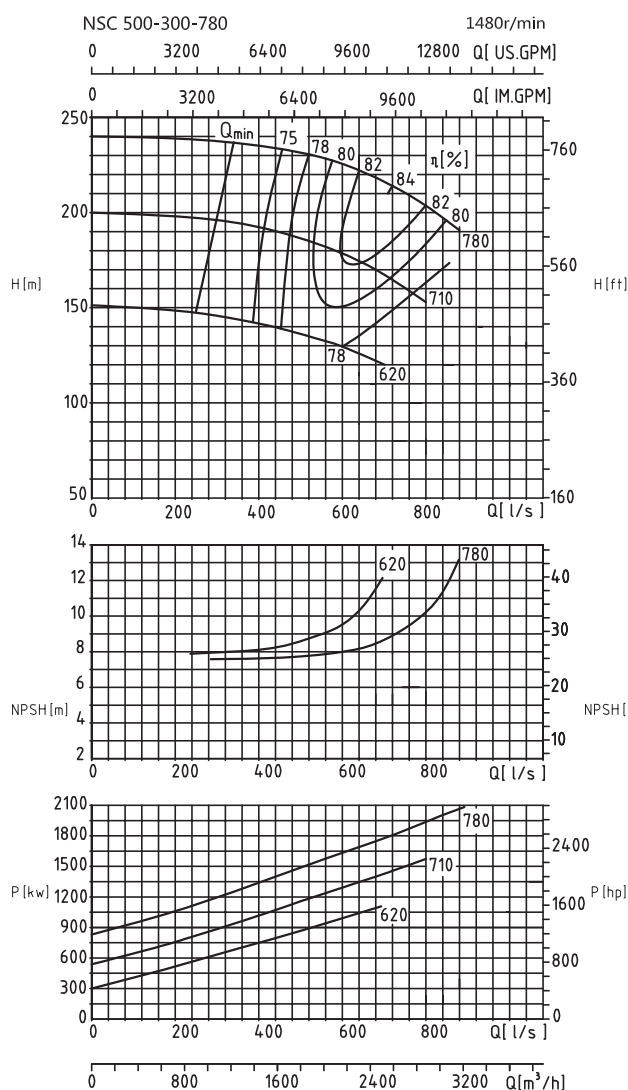

Модель	Производительность		Напор (m)	Скорость (r/min)	Мощность (kw)	Мощность на валу (kw)	КПД (%)	NPSHr (m)	Масса (kg)
	(m³/h)	(L/s)							
NSC500-300-780	2200	611.1	225	1480	2240	1665.3	81	8.0	2800
	2600	722.2	214			1805.0	84	9.0	
	3000	833.3	198.5			2003.4	81	10.9	
NSC500-300-780A	1800	500.0	187		1800	1161.1	79	8.1	
	2200	611.1	178			1301.4	82	8.9	
	2600	722.2	164.5			1456.9	80	10.5	
NSC500-300-780B	1600	444.4	140		1120	792.7	77	8.2	
	1900	527.8	134.5			881.5	79	8.8	
	2200	611.1	128.5			1000.5	77	9.7	
NSC500-300-780L	1980	550.0	225	2240	1498.8	81	8.0		
	2340	650.0	214		1624.5	84	9.0		
	2700	750.0	198.5		1803.0	81	10.9		
NSC500-300-780LA	1620	450.0	187	1800	1045.0	79	8.1		
	1980	550.0	178		1171.2	82	8.9		
	2340	650.0	164.5		1311.2	80	10.5		
NSC500-300-780LB	1440	400.0	140	1120	713.5	77	8.2		
	1710	475.0	134.5		793.3	79	8.8		
	1980	550.0	128.5		900.4	77	9.7		

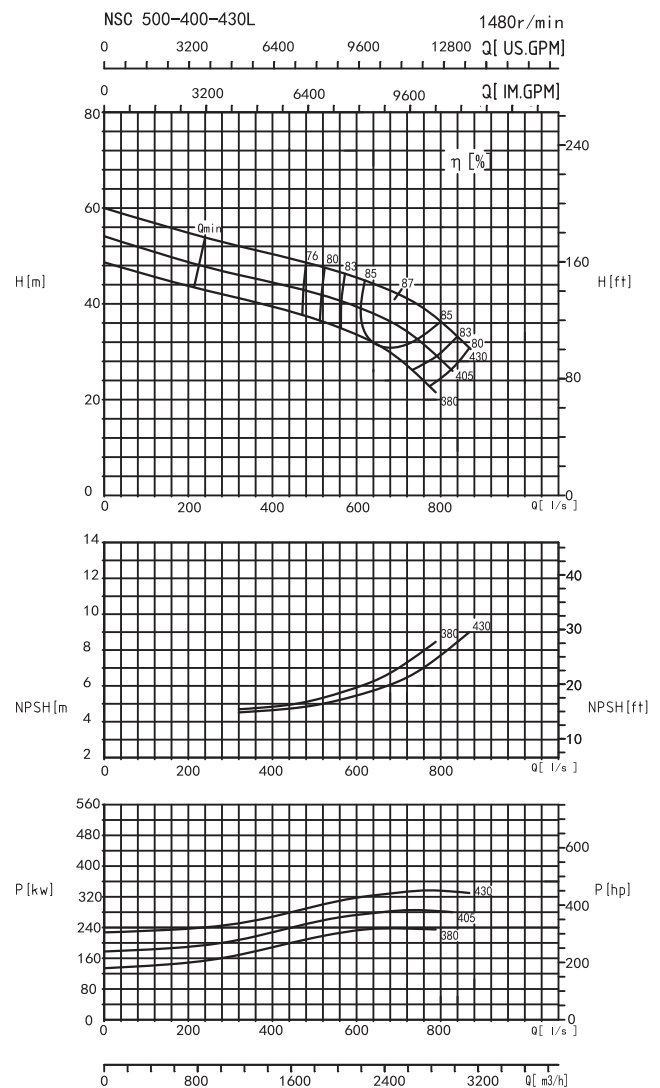
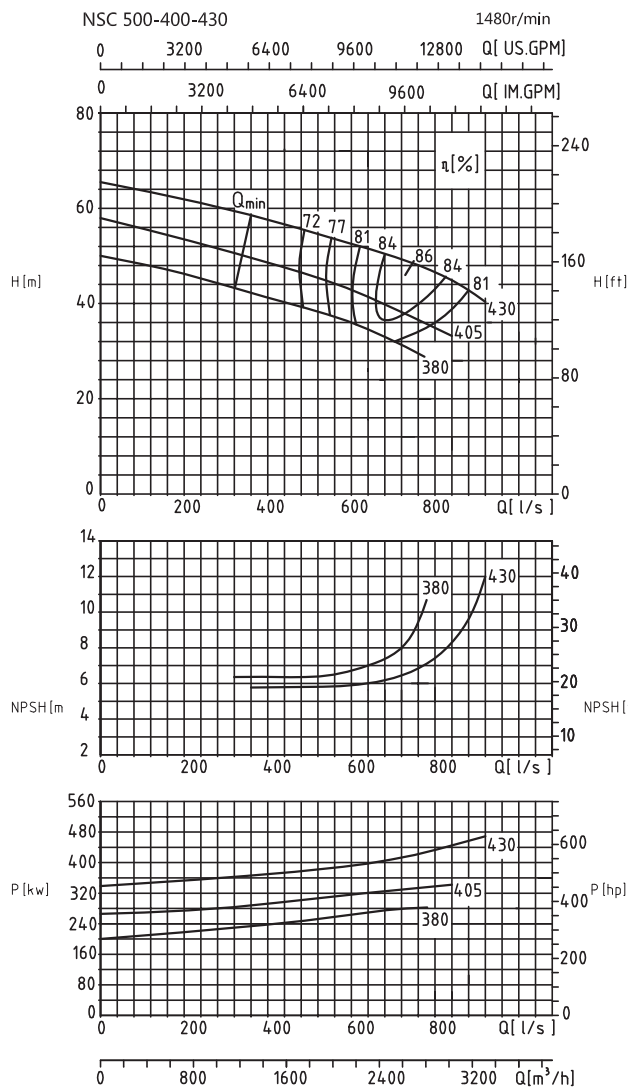

Модель	Производительность		Напор (м)	Скорость (r/min)	Мощность (kw)	Мощность на валу (kw)	КПД (%)	NPSHr (m)	Масса (kg)
	(m³/h)	(L/s)							
NSC500-400-430	2200	611.1	52.5	1480	500	388.6	81	6.0	1350
	2700	750.0	48			410.7	86	6.7	
	3000	833.3	45			437.9	84	8.1	
NSC500-400-430A	2000	555.6	44		450	311.4	77	6.2	
	2430	675.0	40			315.3	84	6.8	
	2800	777.8	36			339.1	81	8.6	
NSC500-400-430B	1800	500.0	38.5		355	258.7	73	6.4	
	2300	638.9	34			259.9	82	7.0	
	2600	722.2	31			271.2	81	8.0	
NSC500-400-430L	2060	572.2	46	400	311.1	83	5.3		
	2500	694.4	42		328.9	87	6.3		
	2900	805.6	36		334.7	85	7.8		
NSC500-400-430LA	2000	555.6	41	315	272.5	82	5.5		
	2400	666.7	37		281.4	86	6.5		
	2800	777.8	30		272.5	84	7.9		
NSC500-400-430LB	2000	555.6	35	280	229.8	83	5.5		
	2300	638.9	32		236.0	85	³ 6.3		
	2650	736.1	26		² 226.2	83	7.5		

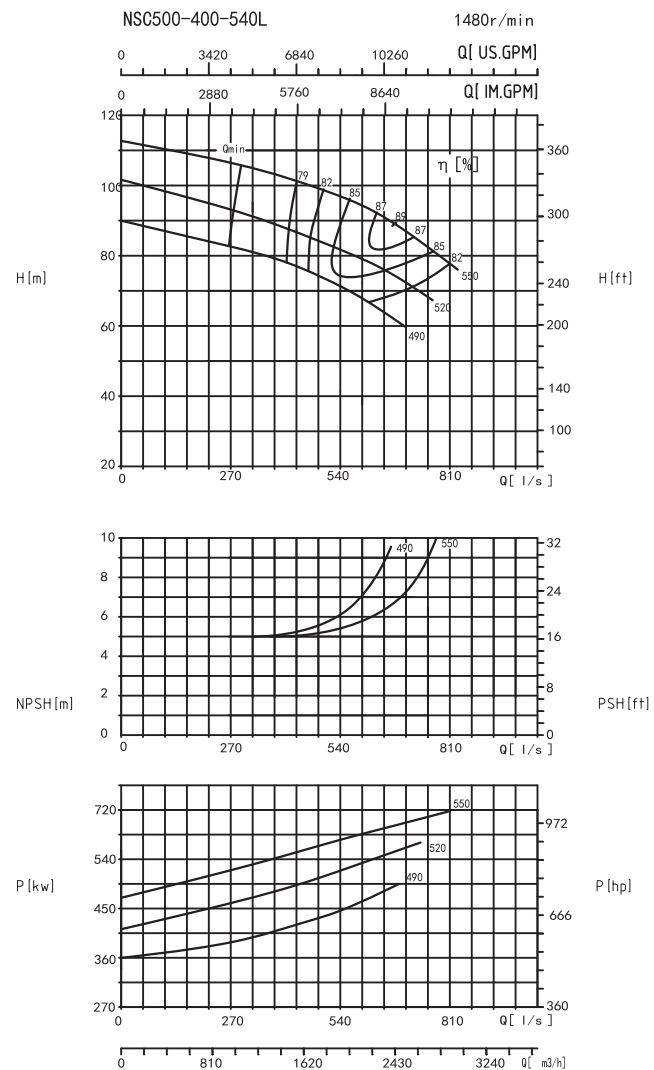
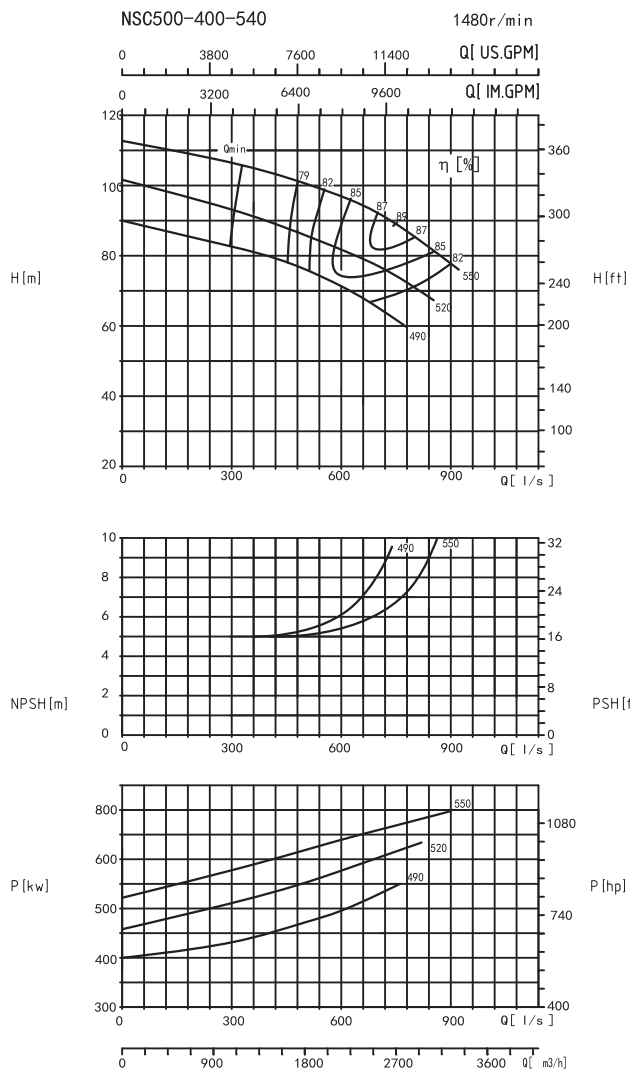

Модель	Производительность		Напор (м)	Скорость (r/min)	Мощность (kw)	Мощность на валу (kw)	КПД (%)	NPSH _r (м)	Масса (kg)
	m ³ /h	L/s							
NSC500-400-540	2250	625.0	96	1480	900	692.5	85	5.7	1870
	2700	750.0	89			735.8	89	6.8	
	3000	833.3	81			779.0	85	9.5	
NSC500-400-540A	1940	538.9	84		800	541.5	82	5.5	
	2400	666.7	79			600.8	86	6.5	
	2800	777.8	72			661.9	83	8.8	
NSC500-400-540B	1480	411.1	76		630	373.8	82	5.5	
	2130	591.7	71			490.6	84	6.1	
	2500	694.4	65			540.0	82	8.0	
NSC500-400-540L	2020	561.1	96	1480	800	621.7	85	5.7	1870
	2430	675.0	89			662.2	89	6.8	
	2700	750.0	81			701.1	85	9.5	
NSC500-400-540LA	1750	486.1	84		710	488.5	82	5.5	
	2160	600.0	79			540.7	86	6.5	
	2520	700.0	72			595.7	83	8.8	
NSC500-400-540LB	1650	458.3	76		560	416.7	82	5.5	
	1930	536.1	71			444.5	84	6.1	
	2250	625.0	65			486.0	82	8.0	

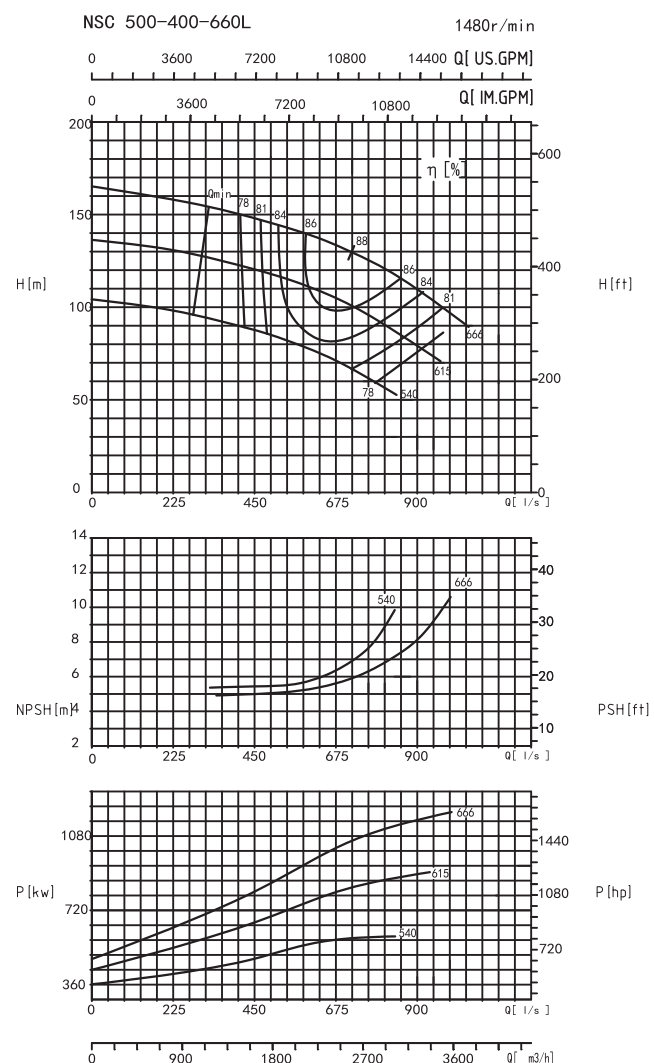
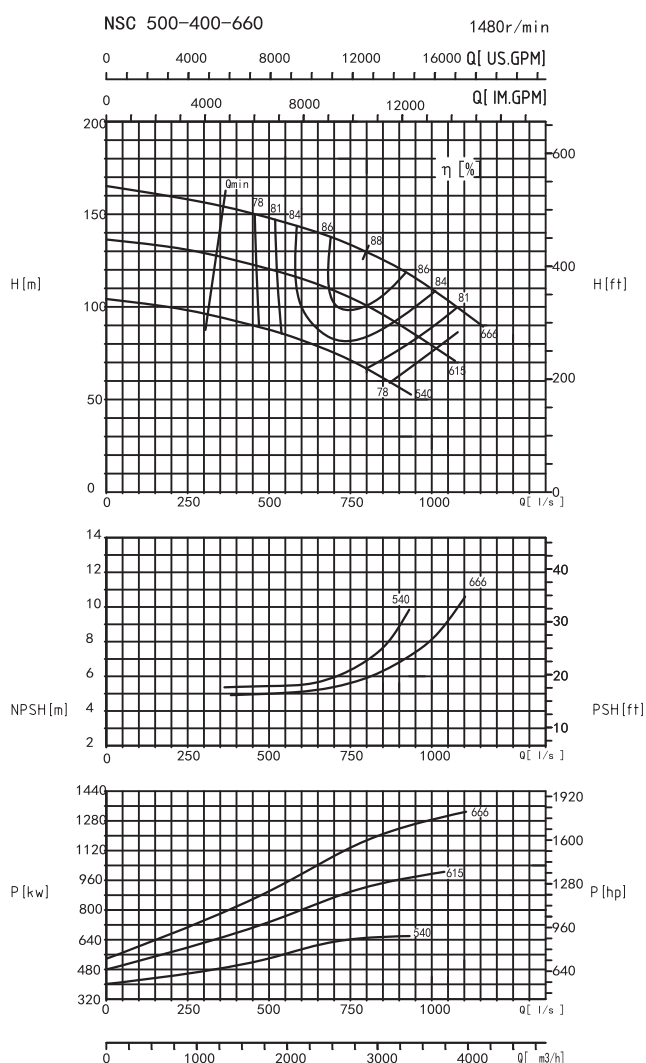

Модель	Производительность		Напор (м)	Скорость (r/min)	Мощность (kw)	Мощность на валу (kw)	КПД (%)	NPSHr (м)	Масса (kg)	
	m ³ /h	L/s								
NSC500-400-660	2100	583.3	143	1480	1400	974.2	84	5.1	2400	
	2886	801.7	128			1143.9	88	6.0		
	3300	916.7	119			1244.3	86	7.2		
NSC500-400-660A	2100	583.3	116		1120	1120	790.3	84		5.3
	2650	736.1	106				879.8	87		6.0
	3100	861.1	95				955.4	84		7.5
NSC500-400-660B	1980	550.0	85		800	800	567.6	80.8		5.5
	2400	666.7	79				630.1	82		5.8
	2880	800.0	67				649.2	81		6.9
NSC500-400-660L	1890	525.0	143	1480	1250	876.8	84	5.1	2400	
	2600	722.2	128			1030.5	88	6.0		
	2970	825.0	119			1119.9	86	7.2		
NSC500-400-660LA	1890	525.0	116		1000	1000	711.2	84		5.3
	2385	662.5	106				791.8	87		6.0
	2790	775.0	95				859.8	84		7.5
NSC500-400-660LB	1780	494.4	85		710	710	510.3	80.8		5.5
	2160	600.0	79				567.1	82		5.8
	2590	719.4	67				583.8	81		6.9

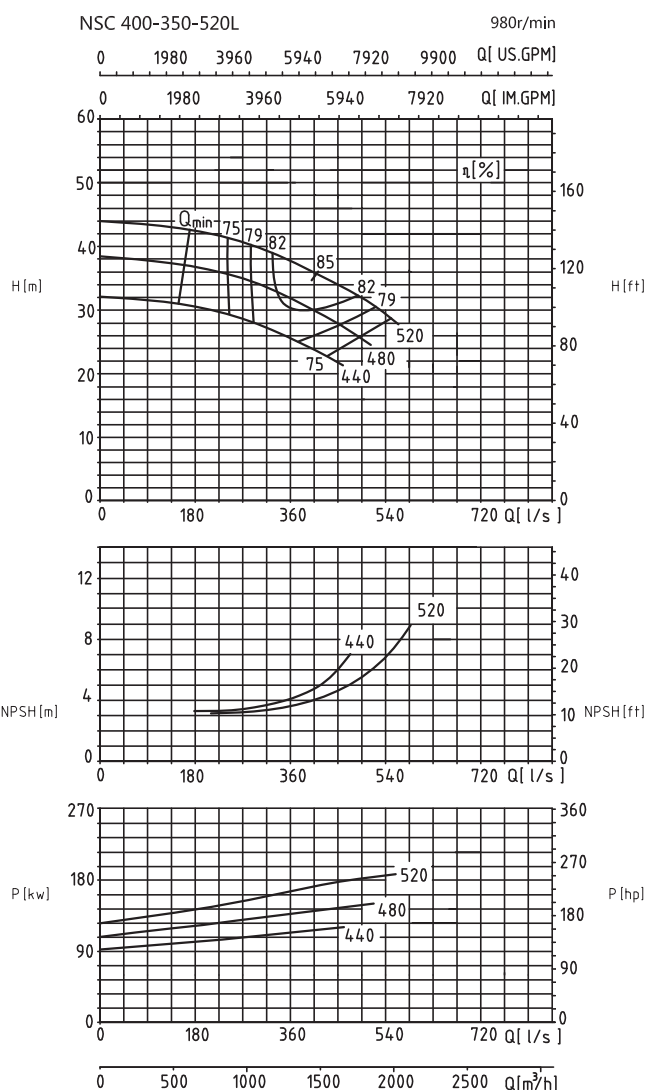
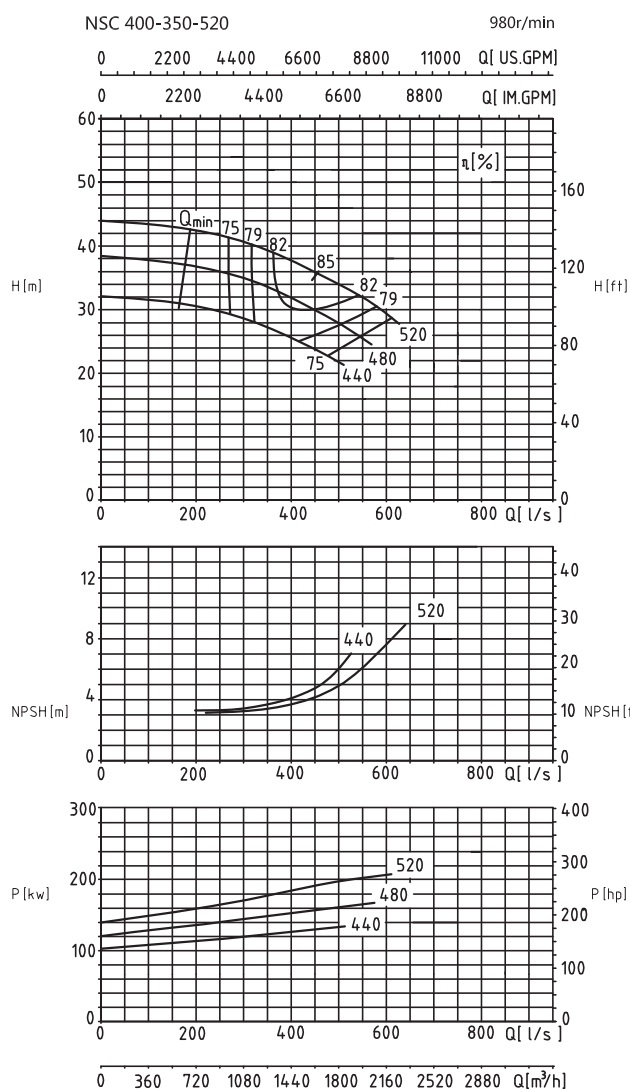

Модель	Производительность		Напор (м)	Скорость (r/min)	Мощность (kw)	Мощность на валу (kw)	КПД (%)	NPSHr (m)	Масса (kg)
	(m³/h)	(L/s)							
NSC400-350-520	1260	350.0	39.2	980	220	166.2	81	3.6	1350
	1600	444.4	36			184.7	85	4.5	
	1960	544.4	32			211.0	81	7.2	
NSC400-350-520A	1260	350.0	33.7		200	142.9	81	3.6	
	1500	416.7	31.3			154.1	83	4.1	
	1800	500.0	28			173.8	79	5.8	
NSC400-350-520B	1260	350.0	27.2		160	116.7	80	3.8	
	1440	400.0	25.5			125.1	80	4.0	
	1620	450.0	23.9			138.8	76	4.8	
NSC400-350-520L	1134	315.0	39.2	980	220	149.5	81	3.6	1350
	1440	400.0	36			166.2	85	4.5	
	1764	490.0	32			189.9	81	7.2	
NSC400-350-520LA	1134	315.0	33.7		200	128.6	81	3.6	
	1350	375.0	31.3			138.7	83	4.1	
	1620	450.0	28			156.5	79	5.8	
NSC400-350-520LB	1134	315.0	27.2		160	105.1	80	3.8	
	1296	360.0	25.5			112.6	80	4.0	
	1458	405.0	23.9			124.9	76	4.8	

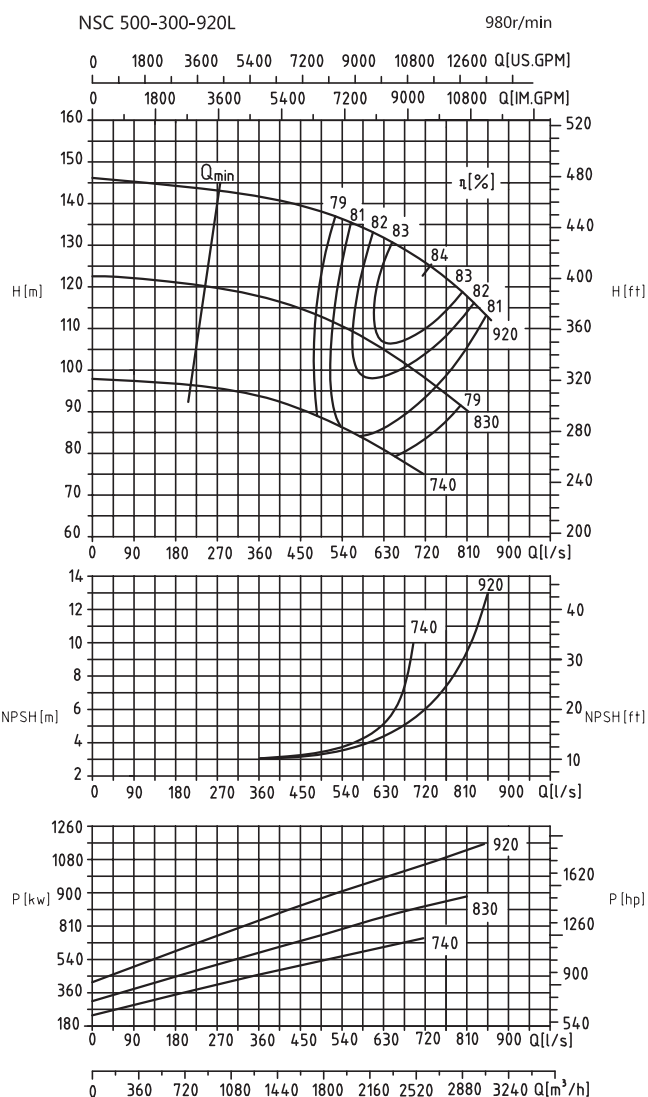
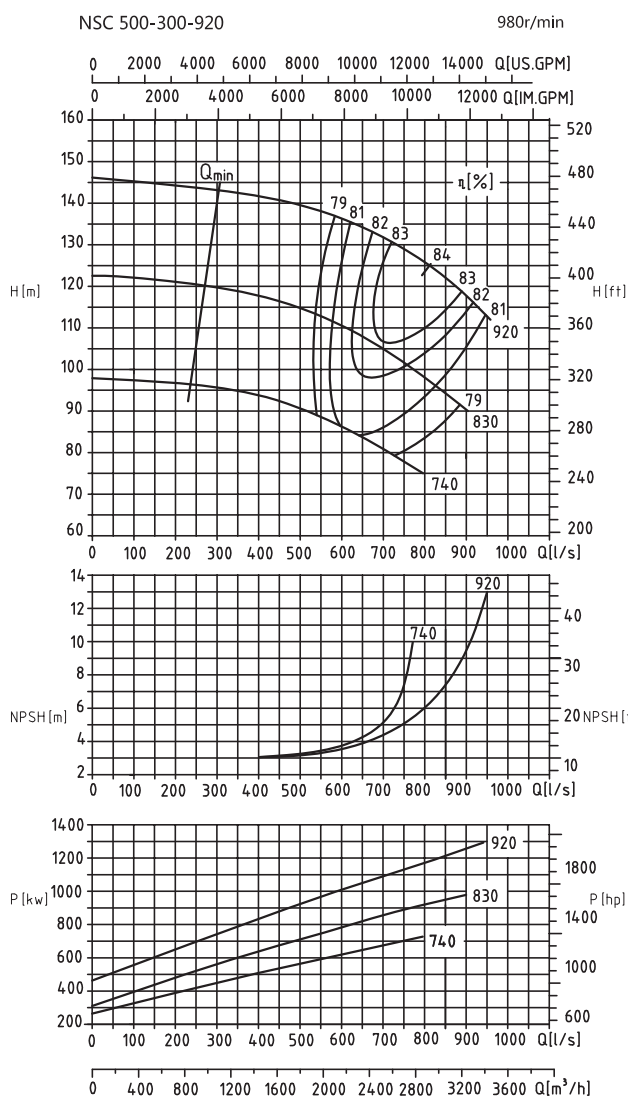

Модель	Производительность		Напор (м)	Скорость (r/min)	Мощность (kw)	Мощность на валу (kw)	КПД (%)	NPSHг (м)	Масса (kg)
	(м ³ /h)	(L/s)							
NSC500-300-920	2600	722.2	130.5	980	1400	1114.0	83	4.7	3000
	2850	791.7	127			1174.2	84	6.2	
	3200	888.9	119			1250.2	83	9.0	
NSC500-300-920A	2160	600.0	110.6		1120	799.7	81.4	3.7	
	2600	722.2	104			893.1	82.5	5.1	
	2880	800.0	98			944.8	81.4	8.0	
NSC500-300-920B	2000	555.6	88		800	601.0	79.8	3.5	
	2300	638.9	84			650.0	81	4.1	
	2700	750.0	78			726.4	79	7.5	
NSC500-300-920L	2340	650.0	130.5	1400	1002.6	83	4.7		
	2565	712.5	127		1056.8	84	6.2		
	2880	800.0	119		1125.2	83	9.0		
NSC500-300-920LA	1944	540.0	110.6	1000	719.8	81.4	3.7		
	2340	650.0	104		803.8	82.5	5.1		
	2592	720.0	98		850.4	81.4	8.0		
NSC500-300-920LB	1800	500.0	88	800	540.9	79.8	3.5		
	2070	575.0	84		585.0	81	4.1		
	2430	675.0	78		653.8	79	7.5		

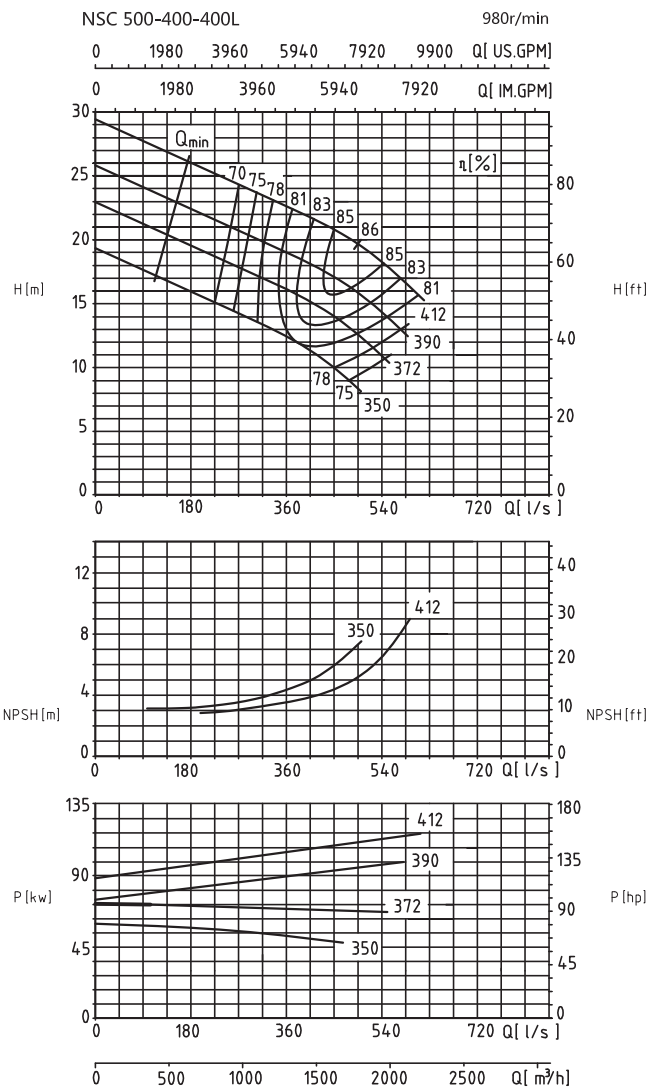
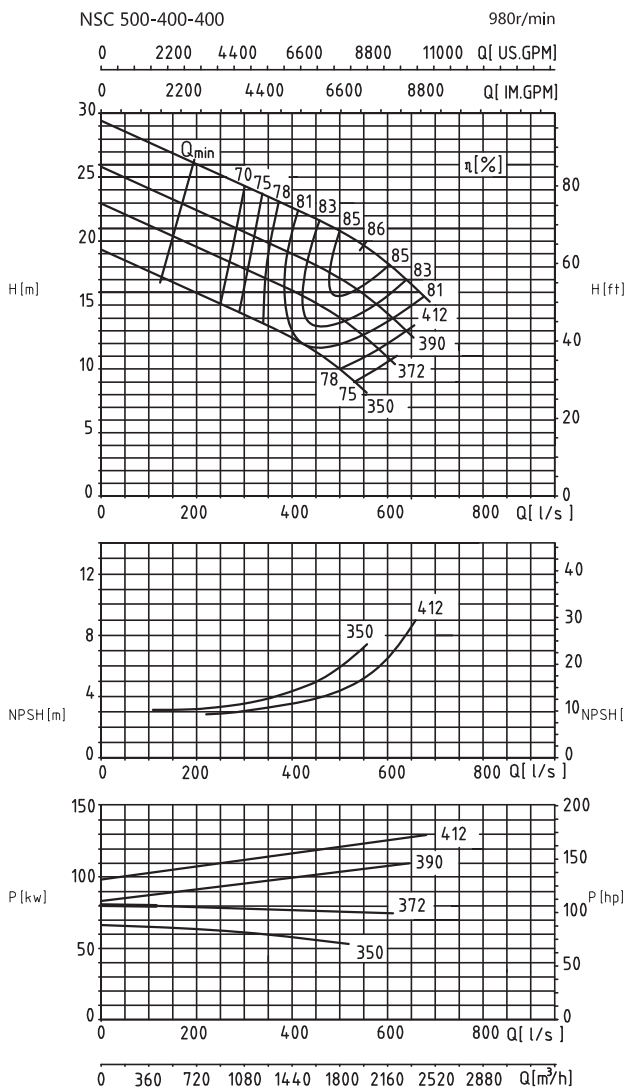

Модель	Производительность		Напор (м)	Скорость (r/min)	Мощность (kw)	Мощность на валу (kw)	КПД (%)	NPSHr (м)	Масса (kg)
	(m³/h)	(L/s)							
NSC500-400-400	1440	400.0	22.6	980	160	110.9	80	3.6	1200
	1800	500.0	20.8			120.0	85	4.3	
	2160	600.0	18.3			126.7	85	6.5	
NSC500-400-400A	1260	350.0	19.8		132	83.9	81	3.7	
	1620	450.0	18.1			94.0	85	4.5	
	1980	550.0	15.8			105.2	81	6.5	
NSC500-400-400B	1170	325.0	17.5		110	73.4	76	3.7	
	1530	425.0	15.7			78.9	83	4.5	
	1890	525.0	13.3			84.6	81	6.0	
NSC500-400-400C	1080	300.0	14.2		90	55.7	75	3.7	
	1440	400.0	12.4			61.6	79	4.4	
	1800	500.0	10			62.9	78	6.0	
NSC500-400-400L	1296	360.0	22.6	980	160	99.8	80	3.6	1200
	1620	450.0	20.8			108.0	85	4.3	
	1944	540.0	18.3			114.0	85	6.5	
NSC500-400-400LA	1134	315.0	19.8		132	75.5	81	3.7	
	1458	405.0	18.1			84.6	85	4.5	
	1782	495.0	15.8			94.7	81	6.5	
NSC500-400-400LB	1053	292.5	17.5		110	66.1	76	3.7	
	1377	382.5	15.7			71.0	83	4.5	
	1701	472.5	13.3			76.1	81	6.0	
NSC500-400-400LC	972	270.0	14.2		90	50.1	75	3.7	
	1296	360.0	12.4			55.4	79	4.4	
	1620	450.0	10			56.6	78	6.0	

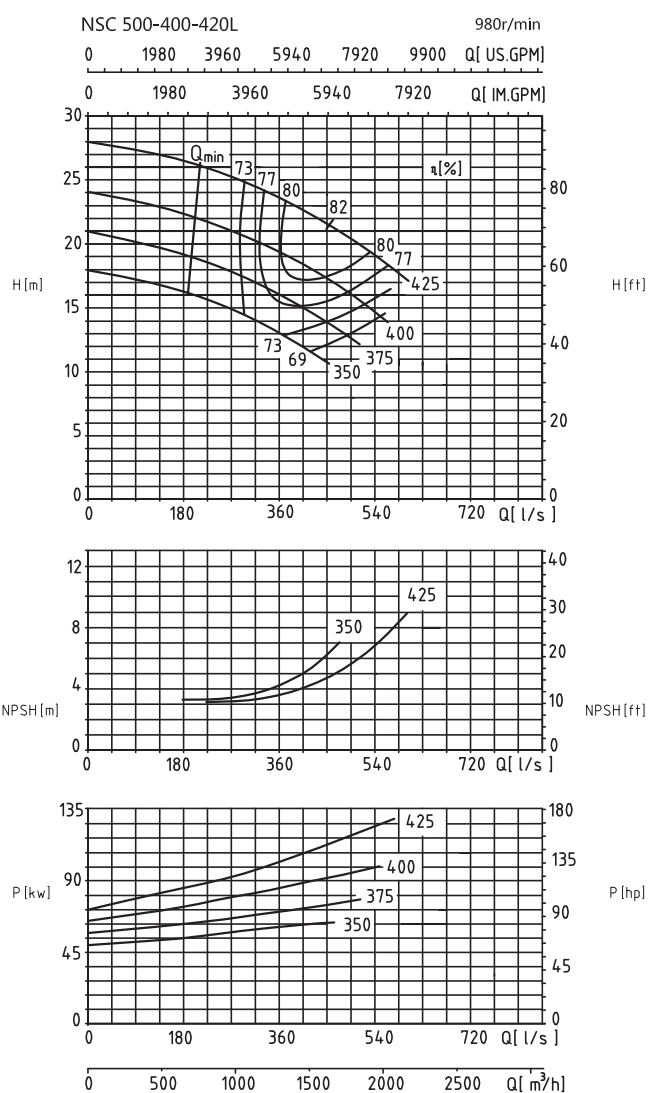
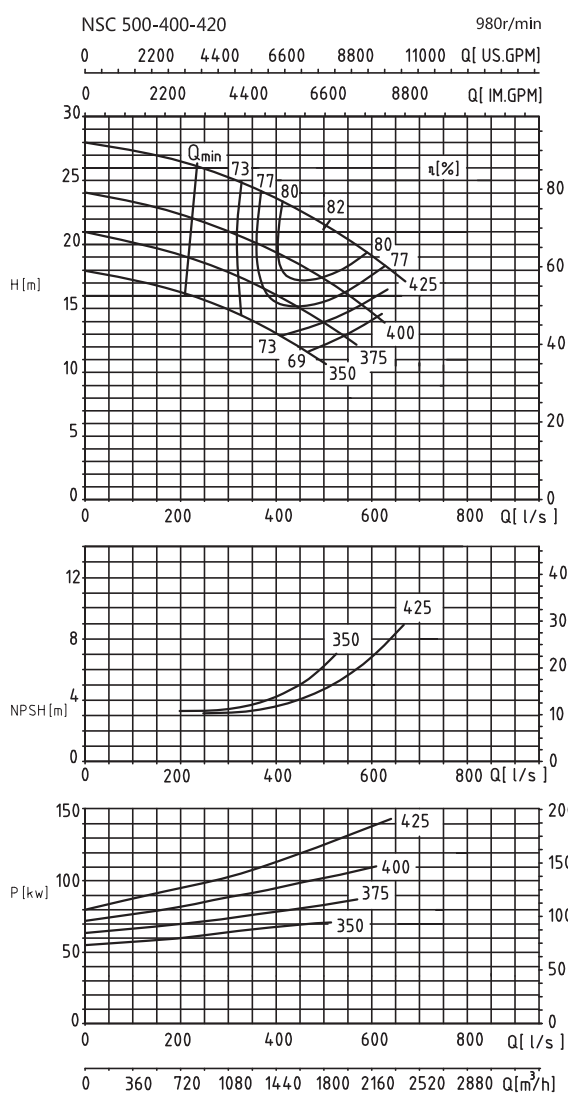

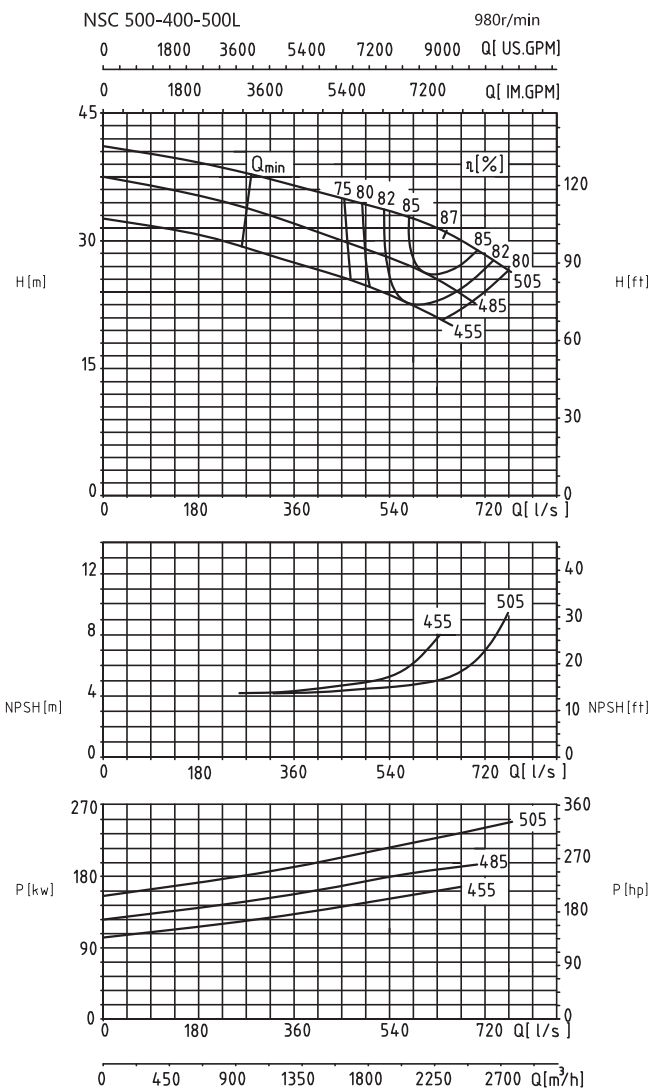
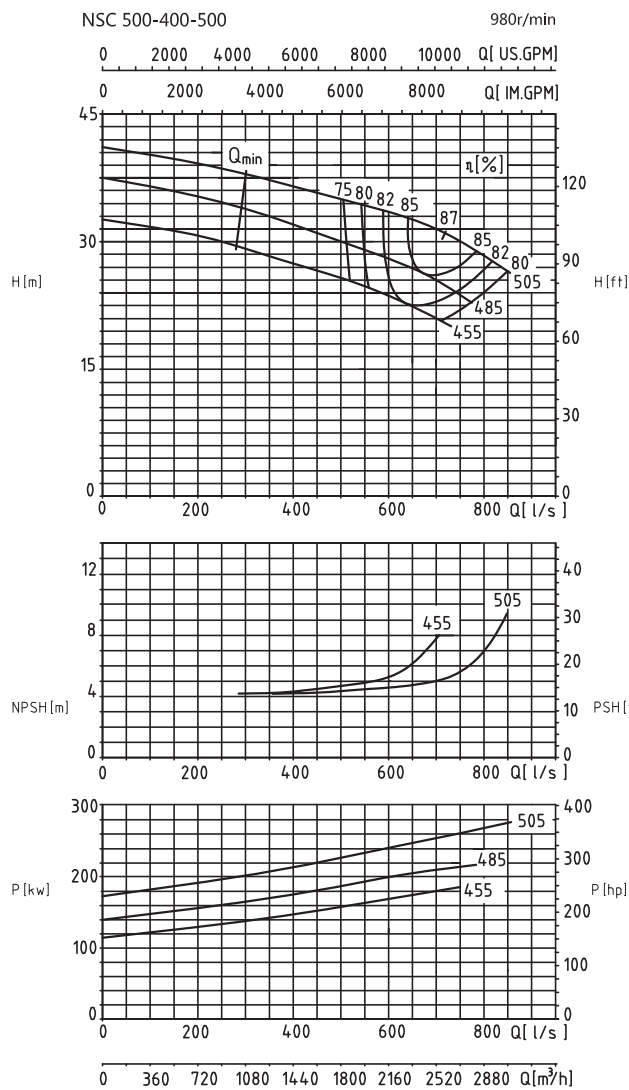

Модель	Производительность		Напор (м)	Скорость (r/min)	Мощность (kw)	Мощность на валу (kw)	КПД (%)	NPSHr (m)	Масса (kg)
	(m³/h)	(L/s)							
NSC500-400-500	2340	650.0	32.6	980	315	243.7	85.3	4.8	1700
	2600	722.2	31			252.5	87	5.2	
	2880	800.0	28.5			267.9	83.5	7.0	
NSC500-400-500A	2160	600.0	28		250	200.5	82.2	4.9	
	2500	694.4	25.5			204.4	85	6.1	
	2700	750.0	24			215.9	81.8	8.0	
NSC500-400-500B	2000	555.6	23.3		220	158.7	80	5.0	
	2330	647.2	22.5			174.2	82	6.0	
	2560	711.1	20.8			181.4	80	9.0	
NSC500-400-500L	2106	585.0	32.6	280	219.3	85.3	4.8		
	2340	650.0	31		227.2	87	5.2		
	2592	720.0	28.5		241.1	83.5	7.0		
NSC500-400-500LA	1944	540.0	28	250	180.4	82.2	4.9		
	2250	625.0	25.5		183.9	85	6.1		
	2430	675.0	24		194.3	81.8	8.0		
NSC500-400-500LB	1800	500.0	23.3	200	142.9	80	5.0		
	2097	582.5	22.5		156.8	82	6.0		
	2304	640.0	20.8		163.2	80	9.0		

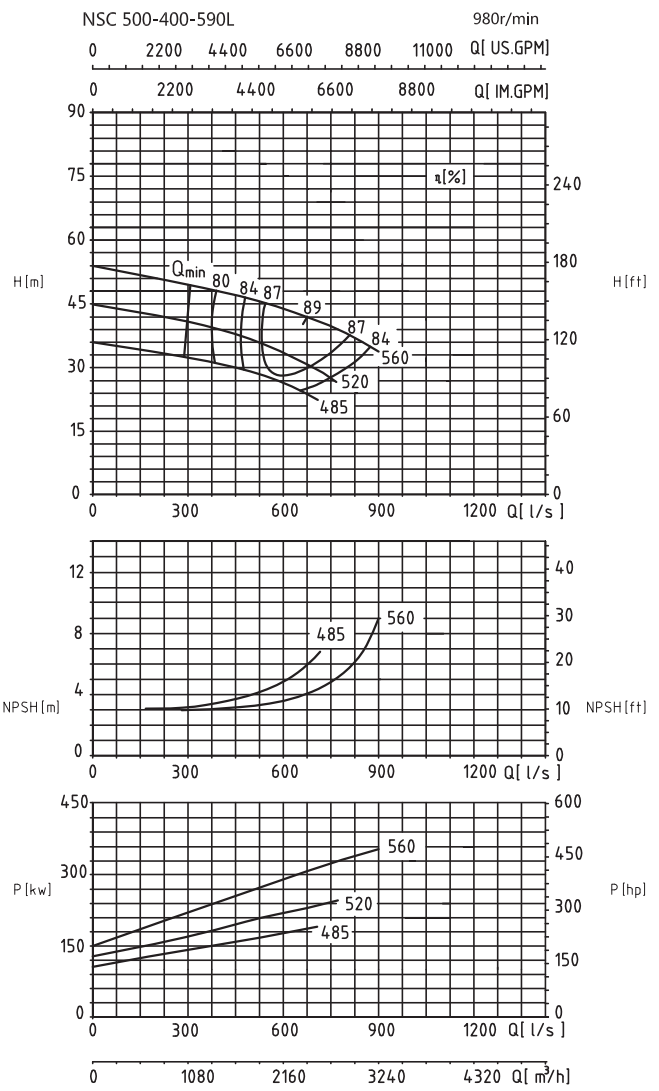
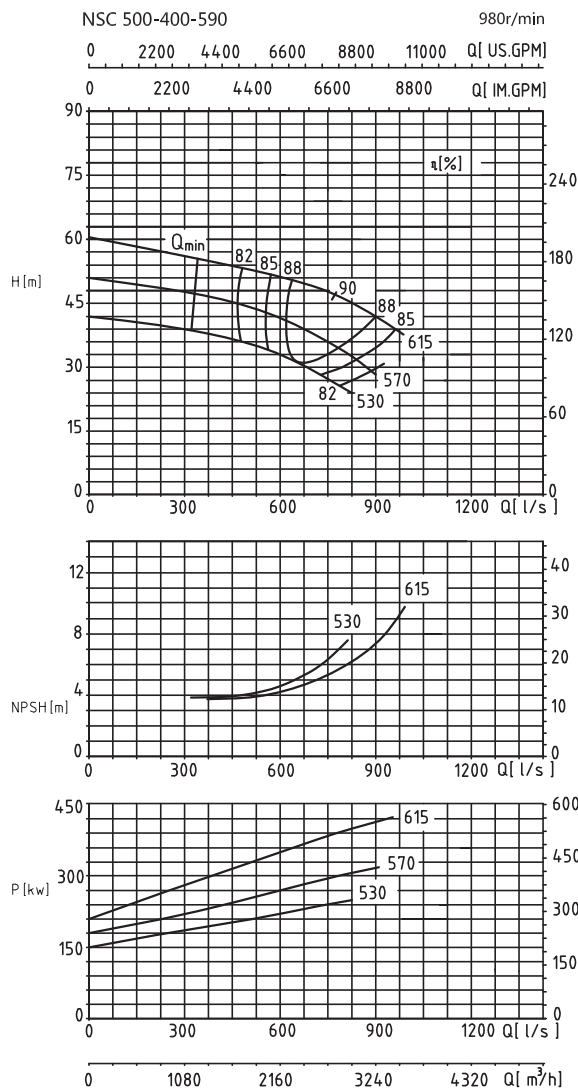

Модель	Производительность		Напор (м)	Скорость (r/min)	Мощность (kw)	Мощность на валу (kw)	КПД (%)	NPSH _r (м)	Масса (kg)
	(m³/h)	(L/s)							
NSC500-400-590	2160	600.0	51.2	980	500	347.2	86.8	4.2	2000
	2780	772.2	47			395.6	90	5.5	
	3240	900.0	42			421.4	88	7.4	
NSC500-400-590A	1981	550.3	42.4		355	268.6	85.2	4.0	
	2430	675.0	39			292.1	88.4	5.0	
	2750	763.9	35.55			305.2	87.3	6.0	
NSC500-400-590B	1787	496.4	35.83		280	207.7	84	4.0	
	1962	545.0	34.65			213.4	86.8	4.2	
	2663.6	739.9	27.73			230.6	87.3	6.0	
NSC500-400-590L	1890	525.0	45.5	400	272.2	86	3.3	2000	
	2440	677.8	42		313.5	89	4.0		
	2970	825.0	37		347.8	86	6.0		
NSC500-400-590LA	1620	450.0	38	280	201.9	83	3.3		
	2300	638.9	32.9		234.1	88	4.7		
	2550	708.3	29.9		244.2	85	5.8		
NSC500-400-590LB	1600	444.4	30	220	159.3	82	3.7		
	2030	563.9	27		175.5	85	4.5		
	2430	675.0	24		189.0	84	6.1		

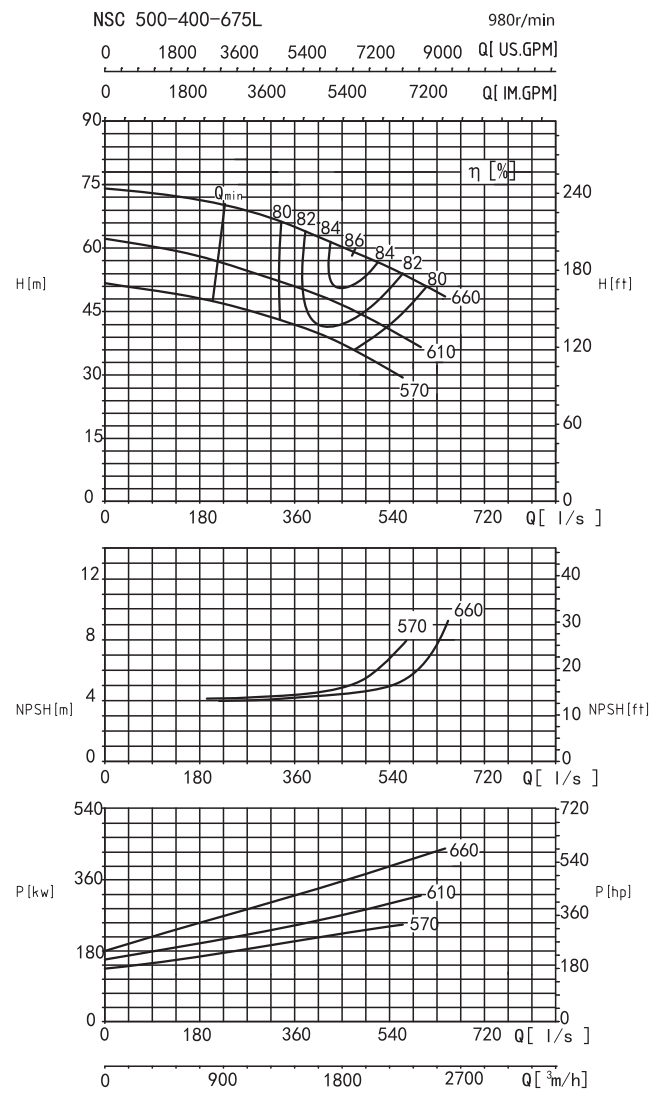
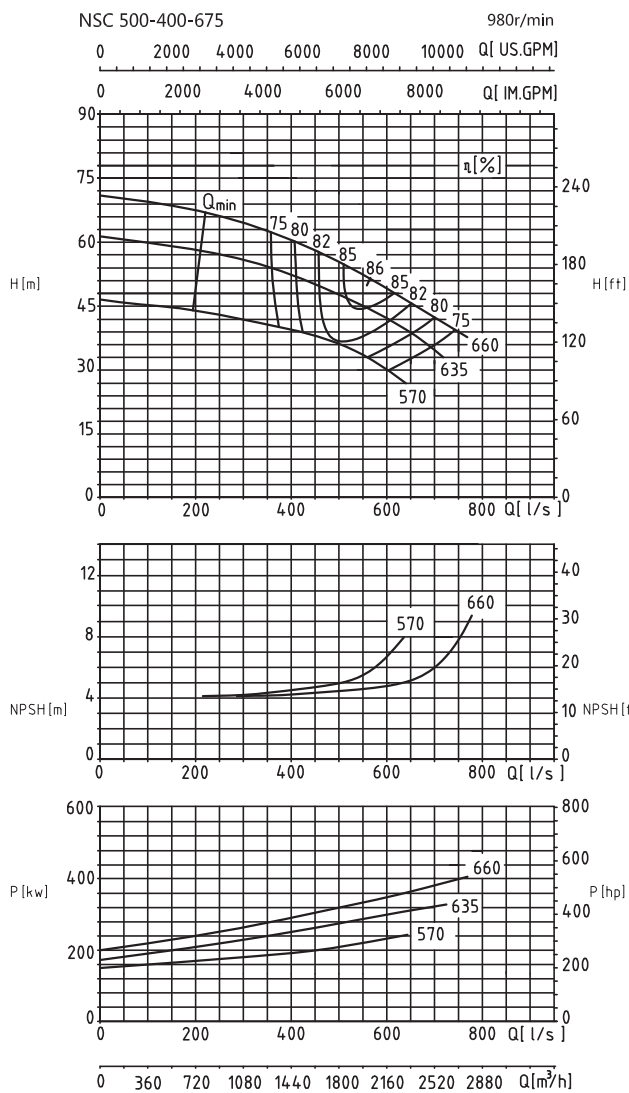

Модель	Производительность		Напор (m)	Скорость (r/min)	Мощность (kw)	Мощность на валу (kw)	КПД (%)	NPSHr (m)	Масса (kg)
	(m³/h)	(L/s)							
NSC500-400-675	1620	450.0	58	980	450	316.1	81	4.2	2000
	2000	555.6	52			329.5	86	4.6	
	2400	666.7	44.6			360.1	81	5.4	
NSC500-400-675A	1540	427.8	51		355	264.2	81	4.5	
	1900	527.8	46.3			282.2	85	4.9	
	2260	627.8	40.4			307.2	81	6.0	
NSC500-400-675B	1540	427.8	39		280	204.6	80	4.6	
	1800	500.0	36			218.0	81	5.0	
	2070	575.0	32			228.5	79	6.0	
NSC500-400-675L	1530	425.0	64	450	325.4	82	4.2		
	1890	525.0	59		353.3	86	4.5		
	2260	627.8	54		405.6	82	5.4		
NSC500-400-675LA	1300	361.1	61	355	266.8	81	4.5		
	1720	477.8	47		265.4	83	4.8		
	2100	583.3	42		300.4	80	5.6		
NSC500-400-675LB	1350	375.0	43	280	197.7	80	4.5		
	1620	450.0	40		218.0	81	4.7		
	1900	527.8	36		233.0	80	5.2		

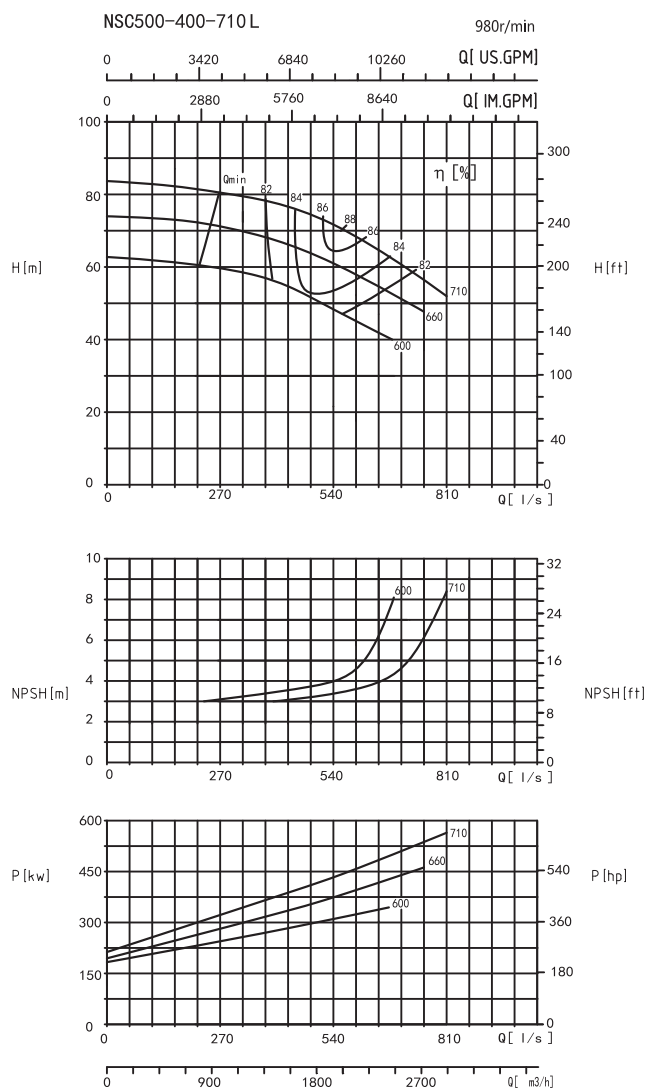
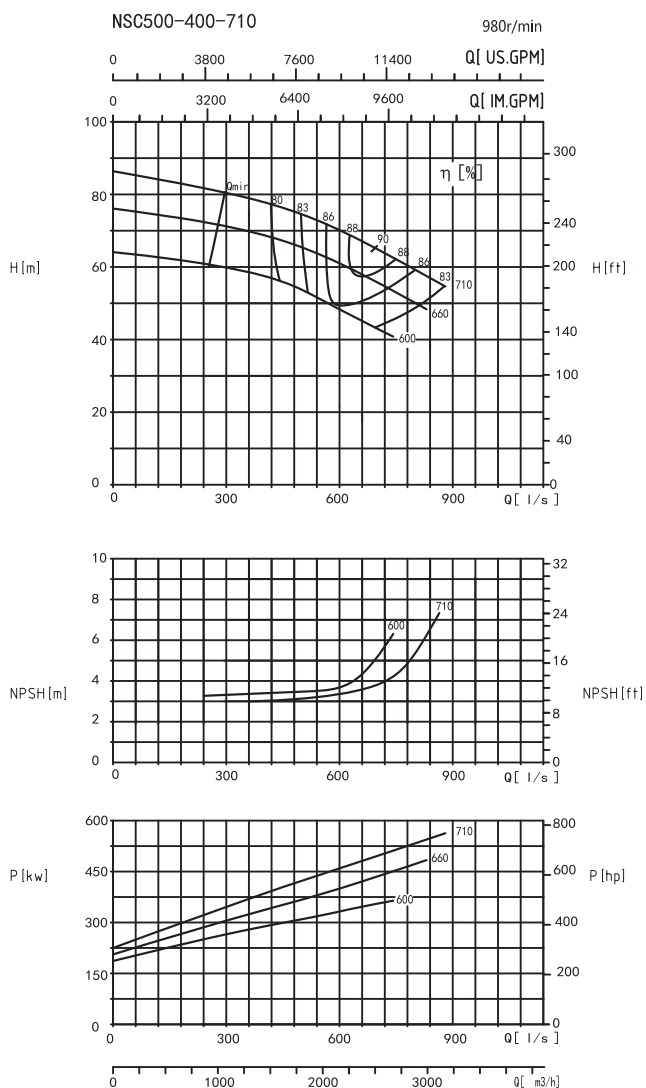

Модель	Производительность		Напор (м)	Скорость (r/min)	Мощность (kw)	Мощность на валу (kw)	КПД (%)	NPSHr (м)	Масса (kg)
	m ³ /h	L/s							
NSC500-400-710	1800	500.0	74	980	630	437.3	83	3.0	2350
	2500	694.4	65			492.0	90	3.8	
	2880	800.0	59.5			543.0	86	5.6	
NSC500-400-710A	1800	500.0	65		500	384.1	83	3.2	
	2380	661.1	58			427.5	88	4.0	
	2750	763.9	52			458.4	85	5.7	
NSC500-400-710B	1850	513.9	52.5		400	318.9	83	4.6	
	2100	583.3	49			329.9	85	5.0	
	2500	694.4	43			352.9	83	6.0	
NSC500-400-710L	1600	444.4	75	560	389.3	84	3.0		
	2020	561.1	70		437.9	88	3.4		
	2450	680.6	62.5		496.7	84	4.5		
NSC500-400-710LA	1570	436.1	66	450	340.2	83	3.3		
	1850	513.9	62		367.7	85	3.6		
	2300	638.9	54		407.8	83	5.0		
NSC500-400-710LB	1550	430.6	55	400	283.3	82	3.5		
	1800	500.0	51		301.4	83	3.8		
	2150	597.2	45		325.5	81	4.7		

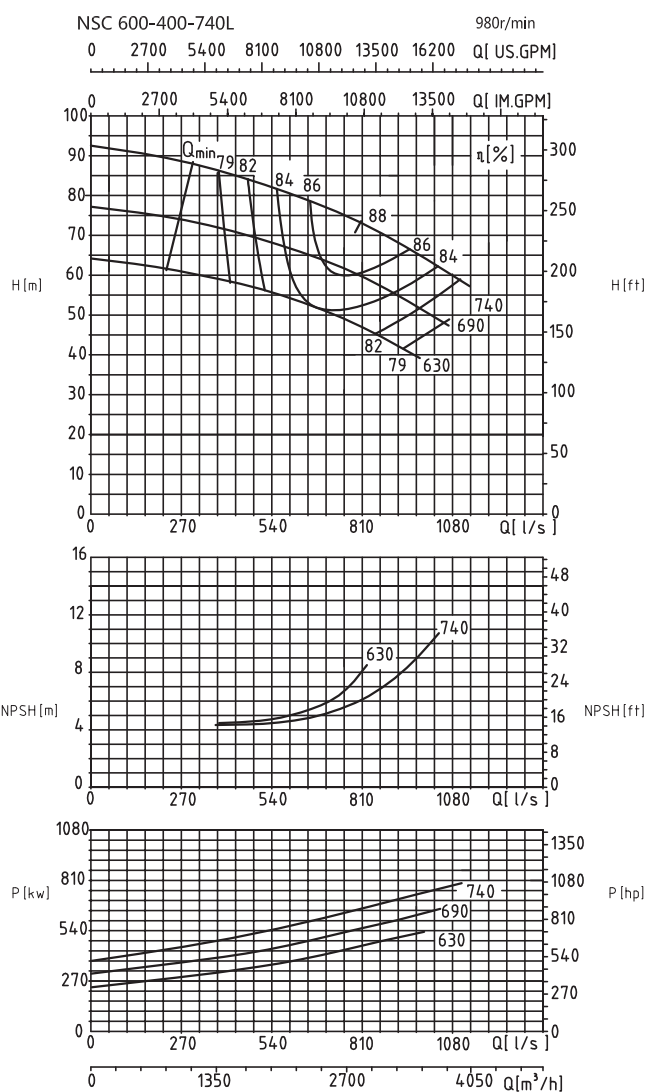
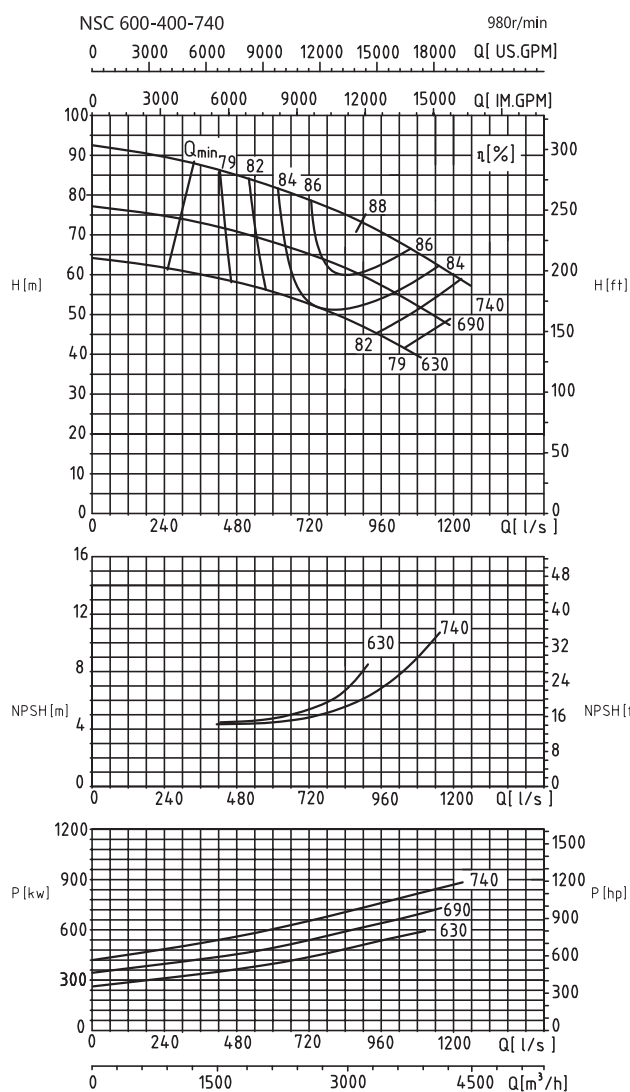

Модель	Производительность		Напор (м)	Скорость (r/min)	Мощность (kw)	Мощность на валу (kw)	КПД (%)	NPSHr (m)	Масса (kg)
	(m³/h)	(L/s)							
NSC600-400-740	2175	604.2	81.6	980	900	575.8	84	4.5	2850
	3200	888.9	72.8			721.4	88	6.1	
	3888	1080.0	65.6			813.8	85.4	9.8	
NSC600-400-740A	2100	583.3	68.3		710	469.8	83.2	4.6	
	2950	819.4	62			579.5	86	6.0	
	3456	960.0	57.5			639.3	84.7	9.2	
NSC600-400-740B	1944	540.0	57		560	371.9	81.2	4.7	
	2600	722.2	53.5			451.2	84	5.6	
	3240	900.0	47			501.8	82.7	8.5	
NSC600-400-740L	1958	543.8	81.6	900	518.2	84	4.5		
	2880	800.0	72.8		649.2	88	6.1		
	3499	972.0	65.6		732.5	85.4	9.8		
NSC600-400-740LA	1890	525.0	68.3	710	422.8	83.2	4.6		
	2655	737.5	62		521.6	86	6.0		
	3110	864.0	57.5		575.4	84.7	9.2		
NSC600-400-740LB	1750	486.0	57	560	334.7	81.2	4.7		
	2340	650.0	53.5		406.1	84	5.6		
	2916	810.0	47		451.6	82.7	8.5		

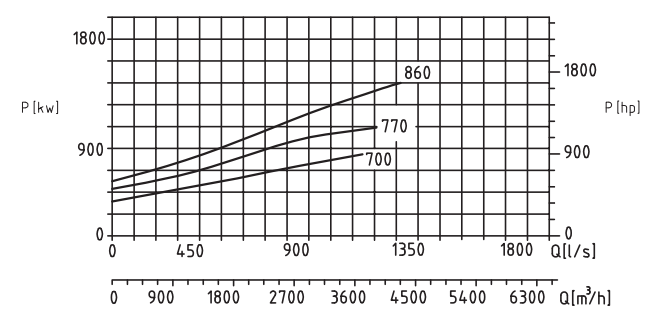
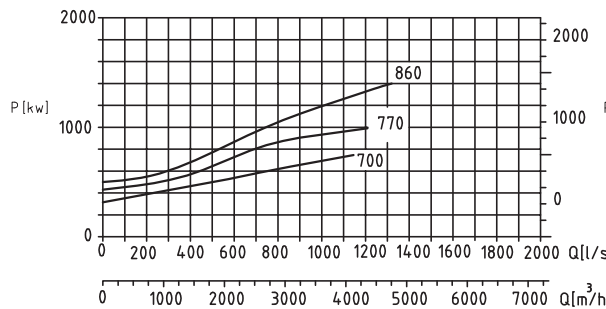
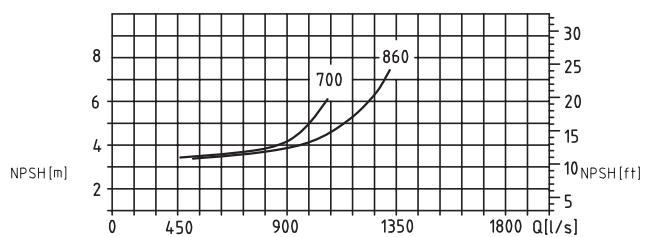
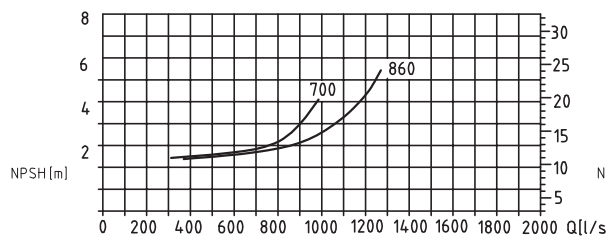
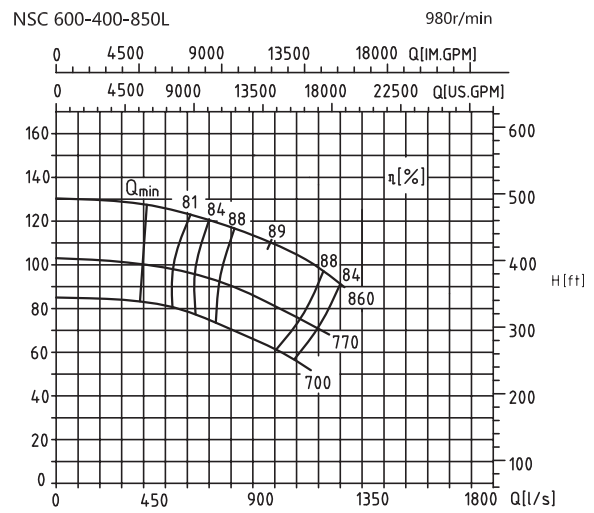
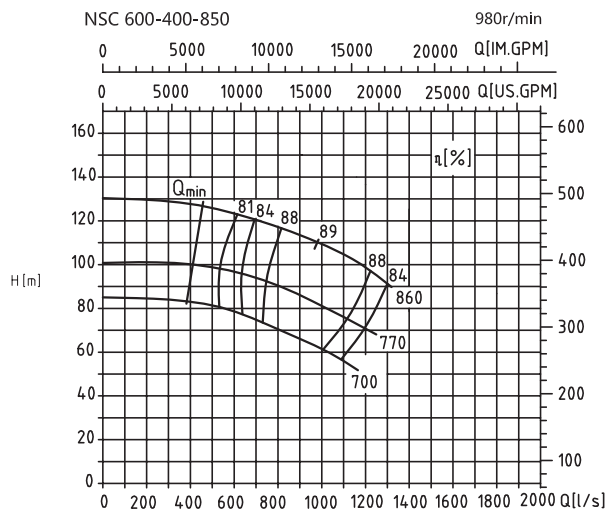

Модель	Производительность		Напор (м)	Скорость (r/min)	Мощность (kw)	Мощность на валу (kw)	КПД (%)	NPSH _г (м)	Масса (kg)
	(м³/h)	(L/s)							
NSC600-400-850	2840	788.9	117.5	980	1600	1052.5	86.4	3.9	3800
	3470	963.9	109.8			1166.6	89	4.6	
	4246	1179.4	100			1308.9	88.4	6.1	
NSC600-400-850A	2702	750.6	92.9		1120	781.7	87.5	4.0	
	3347	929.7	83.4			854.7	89	5.0	
	3940	1094.4	75.85			923.3	88.2	6.9	
NSC600-400-850B	2520	700.0	75		900	601.7	85.6	3.9	
	3107	863.1	67.5			649.4	88	4.8	
	3600	1000.0	61.6			693.0	87.2	6.5	
NSC600-400-850L	2556	710.0	117.5	980	1400	947.2	86.4	3.9	3800
	3123	867.5	109.8			1049.9	89	4.6	
	3821	1061.5	100			1178.0	88.4	6.1	
NSC600-400-850LA	2432	675.5	92.9		1120	703.6	87.5	4.0	
	3012	836.8	83.4			769.2	89	5.0	
	3546	985.0	75.85			831.0	88.2	6.9	
NSC600-400-850LB	2268	630.0	75		900	541.5	85.6	3.9	
	2796	776.8	67.5			584.5	88	4.8	
	3240	900.0	61.6			623.7	87.2	6.5	

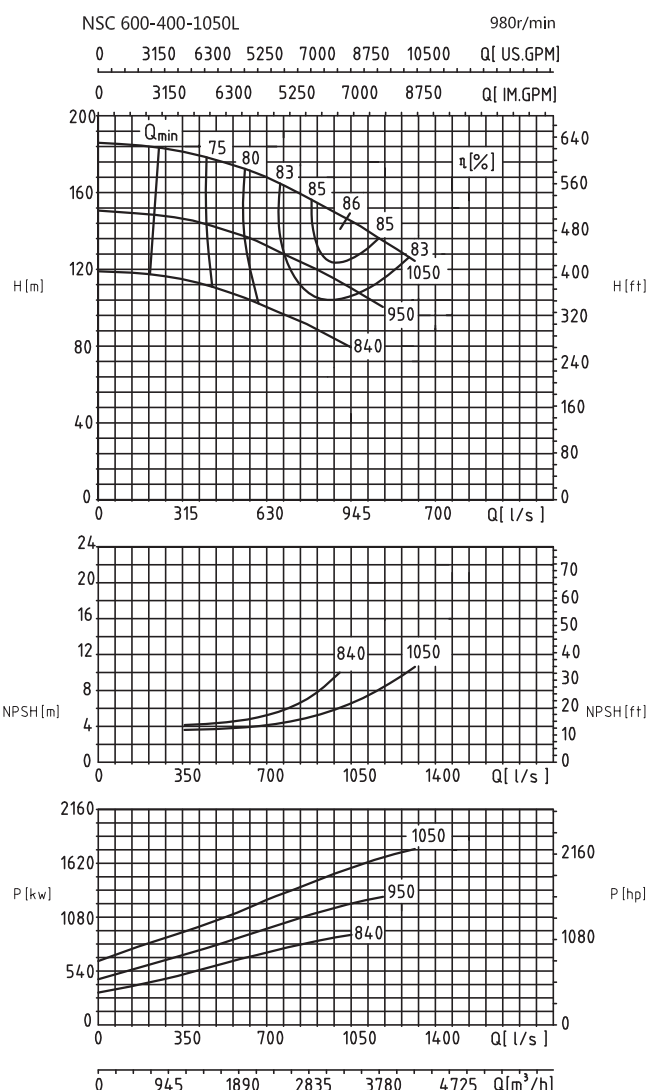
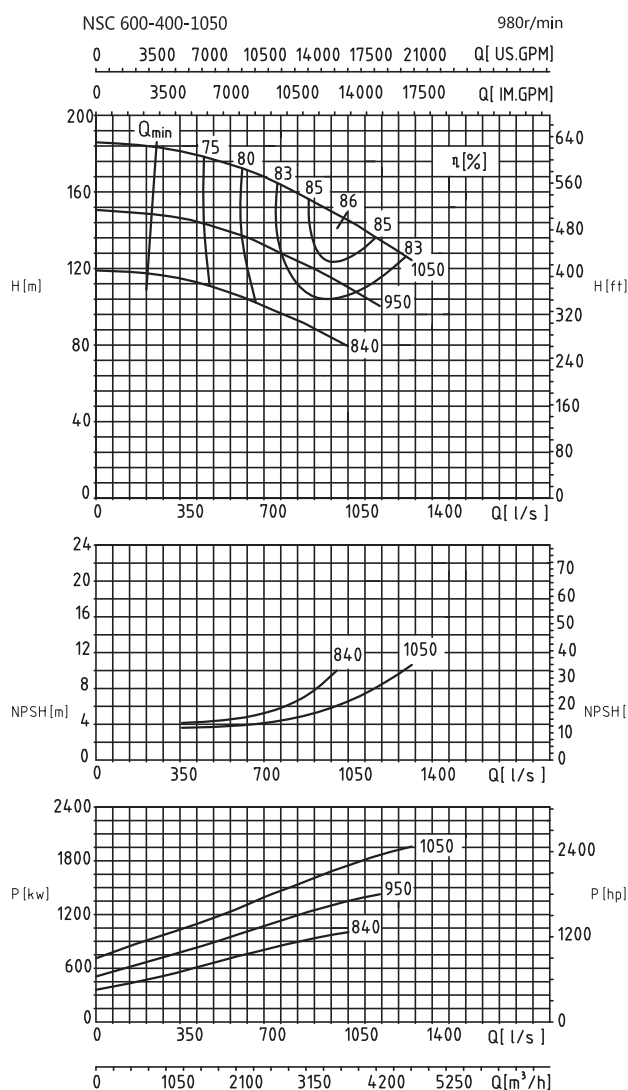

Модель	Производительность		Напор (м)	Скорость (r/min)	Мощность (kw)	Мощность на валу (kw)	КПД (%)	NPSHг (м)	Масса (kg)
	(m³/h)	(L/s)							
NSC600-400-1050	2720	755.6	164	980	2000	1464.5	83	4.5	6400
	3600	1000.0	145			1654.0	86	6.2	
	4460	1238.9	130			1816.0	87	9.0	
NSC600-400-1050A	2520	700.0	132		1600	1119.1	81	4.6	
	3260	905.6	120			1269.1	84	7.1	
	3930	1091.7	108			1393.5	83	9.9	
NSC600-400-1050B	2270	630.6	104		1250	814.3	79	5.0	
	2780	772.2	96			897.8	81	6.0	
	3360	933.3	88			1007.2	80	8.5	
NSC600-400-1050L	2448	680.0	164	2000	1318.1	83	4.5	6400	
	3240	900.0	145		1488.6	86	6.2		
	4014	1115.0	130		1634.4	87	9.0		
NSC600-400-1050LA	2268	630.0	132	1600	1007.2	81	4.6		
	2934	815.0	120		1142.2	84	7.1		
	3537	982.5	108		1254.1	83	9.9		
NSC600-400-1050LB	2043	567.5	104	1120	732.9	79	5.0		
	2502	695.0	96		808.1	81	6.0		
	3024	840.0	88		906.4	80	8.5		

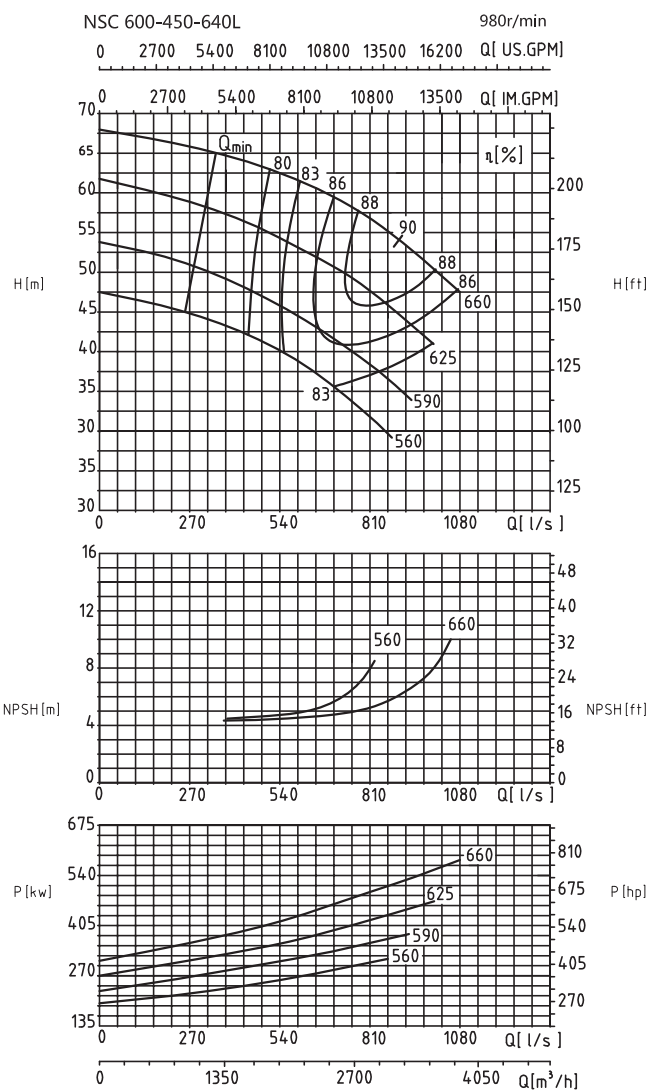
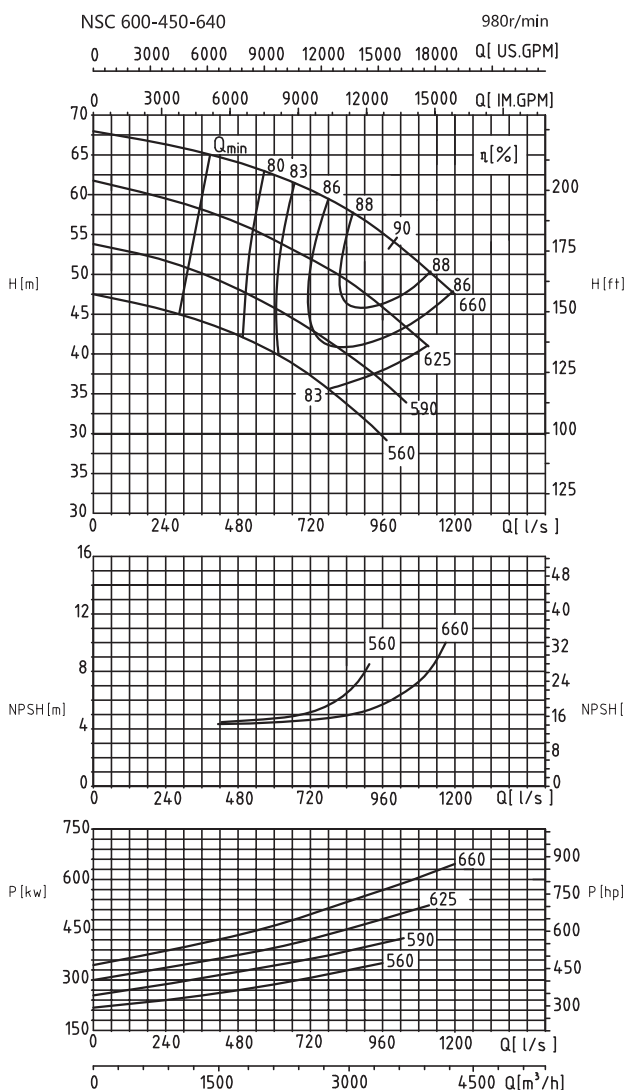

Модель	Производительность		Напор (м)	Скорость (r/min)	Мощность (kw)	Мощность на валу (kw)	КПД (%)	NPSHr (м)	Масса (kg)
	(m³/h)	(L/s)							
NSC600-450-640	3000	833.3	58	980	710	545.0	87	5.0	2800
	3600	1000.0	53.6			597.5	88	6.3	
	4100	1138.9	49			644.1	85	9.3	
NSC600-450-640A	2400	666.7	52.6		560	404.7	85	4.8	
	3000	833.3	49			455.2	88	5.8	
	3600	1000.0	44			501.9	86	7.9	
NSC600-450-640B	2100	583.3	45.9		450	316.5	83	4.7	
	2700	750.0	42.1			360.2	86	5.1	
	3300	916.7	37.5			406.3	83	7.5	
NSC600-450-640C	1800	500.0	42		400	257.5	80	4.6	
	2400	666.7	38.2			297.4	84	5.0	
	3000	833.3	33.5			338.1	81	6.7	
NSC600-450-640L	2700	750.0	58	710	490.5	87	5.0		
	3240	900.0	53.6		537.8	88	6.3		
	3690	1025.0	49		579.7	85	9.3		
NSC600-450-640LA	2160	600.0	52.6	560	364.2	85	4.8		
	2700	750.0	49		409.7	88	5.8		
	3240	900.0	44		451.7	86	7.9		
NSC600-450-640LB	1890	525.0	45.9	450	284.8	83	4.7		
	2430	675.0	42.1		324.2	86	5.1		
	2970	825.0	37.5		365.7	83	7.5		
NSC600-450-640LC	1620	450.0	42	400	231.8	80	3 4.6		
	2160	600.0	38.2		2 267.7	84	5.0		
	2700	750.0	33.5		304.3	81	6.7		

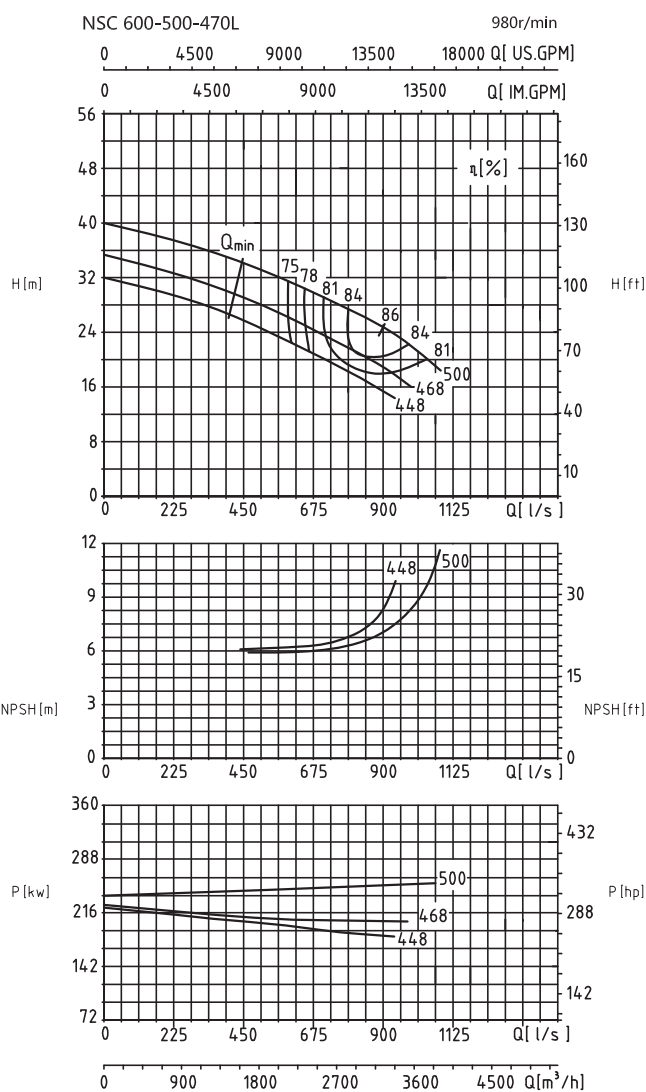
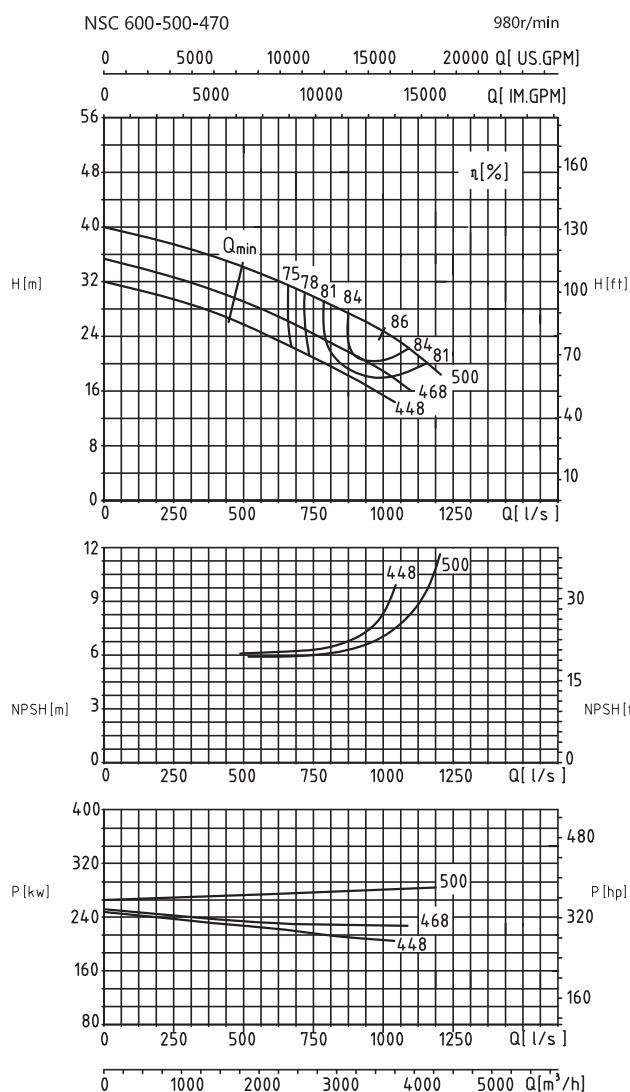

Модель	Производительность		Напор (m)	Скорость (r/min)	Мощность (kw)	Мощность на валу (kw)	КПД (%)	NPSH _r (m)	Масса (kg)
	(m ³ /h)	(L/s)							
NSC600-500-470	3150	875.0	27.4	980	315	280.0	84	6.0	2500
	3600	1000.0	24.8			282.9	86	7.0	
	4050	1125.0	21.2			287.1	81.5	9.0	
NSC600-500-470A	2925	812.5	23		280	224.9	81.5	6.3	
	3375	937.5	20			219.0	84	7.1	
	3712	1031.1	18.1			226.0	81	8.0	
NSC600-500-470B	2785	773.6	19.6		250	201.0	74	6.4	
	3185.8	884.9	17.8			196.8	78.5	6.8	
	3657.7	1016.0	15.6			199.3	78	8.8	
NSC600-500-470L	2835	787.5	27.4	315	252.0	84	6.0		
	3240	900.0	24.8		254.6	86	7.0		
	3645	1012.5	21.2		258.4	81.5	9.0		
NSC600-500-470LA	2633	731.3	23	250	202.4	81.5	6.3		
	3038	843.8	20		197.1	84	7.1		
	3341	928.0	18.1		203.4	81	8.0		
NSC600-500-470LB	2507	696.3	19.6	220	180.9	74	6.4		
	2867	796.5	17.8		177.2	78.5	6.8		
	3292	914.4	15.6		179.4	78	8.8		

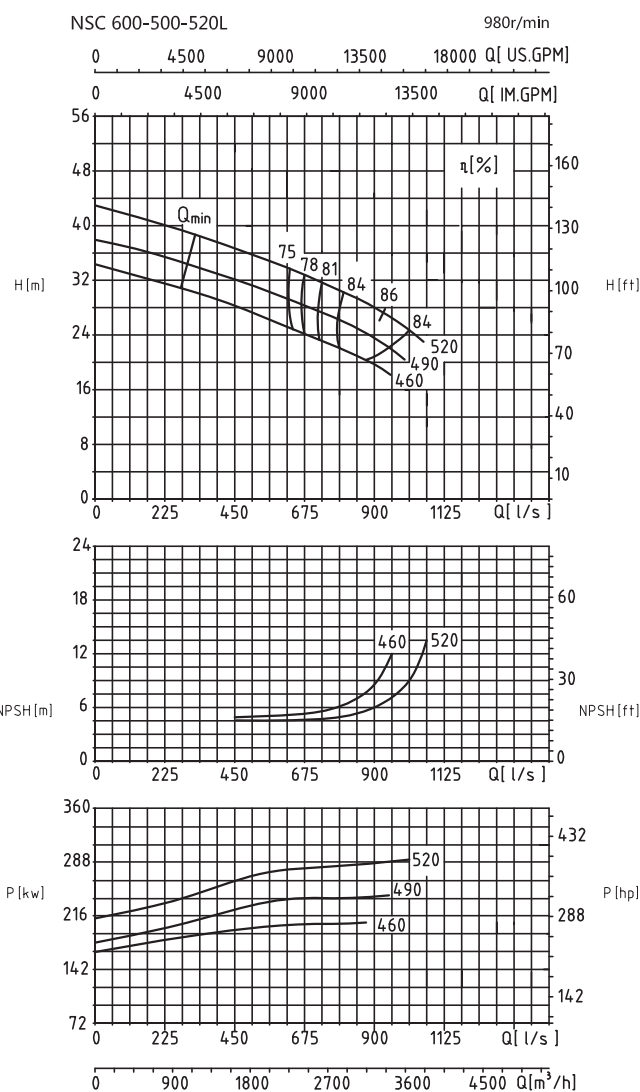
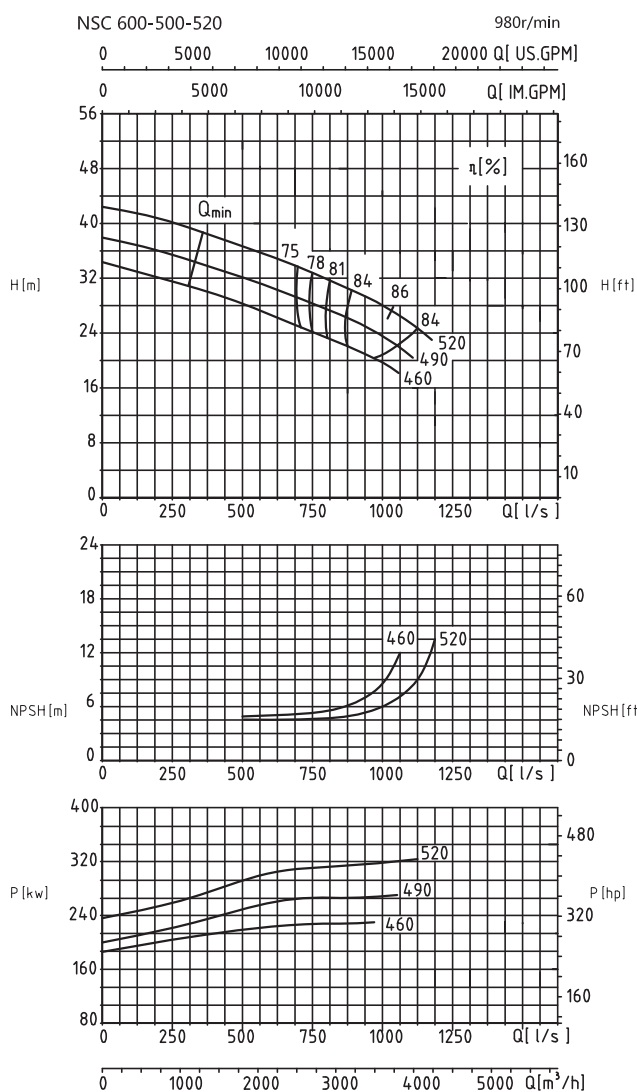

Модель	Производительность		Напор (м)	Скорость (r/min)	Мощность (kw)	Мощность на валу (kw)	КПД (%)	NPSHr (m)	Масса (kg)
	(m ³ /h)	(L/s)							
NSC600-500-520	3150	875.0	30.5	980	355	313.2	83.6	5.0	2520
	3720	1033.3	27.3			321.8	86	6.7	
	4050	1125.0	24.2			317.9	84	9.0	
NSC600-500-520A	2925	812.5	27.3		315	265.4	82	5.5	
	3500	972.2	24.3			269.5	86	6.7	
	3825	1062.5	22			275.3	83.3	9.0	
NSC600-500-520B	2798	777.2	23.3		280	222.1	80	5.5	
	3300	916.7	21.5			227.5	85	6.7	
	3672	1020.0	19.1			231.7	82.5	8.8	
NSC600-500-520L	2835	787.5	30.5	355	281.8	83.6	5.0		
	3348	930.0	27.3		289.6	86	6.7		
	3645	1012.5	24.2		286.2	84	9.0		
NSC600-500-520LA	2633	731.3	27.3	315	238.8	82	5.5		
	3150	875.0	24.3		242.5	86	6.7		
	3443	956.3	22		247.8	83.3	9.0		
NSC600-500-520LB	2518	699.5	23.3	280	199.9	80	5.5		
	2970	825.0	21.5		204.7	85	6.7		
	3305	918.0	19.1		208.5	82.5	8.8		

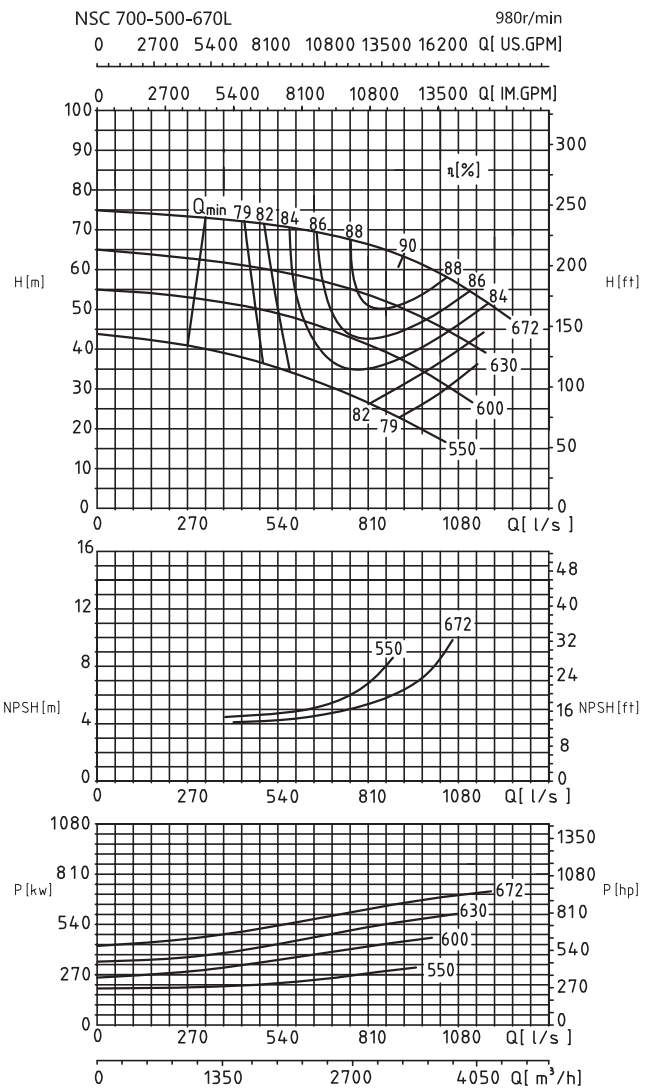
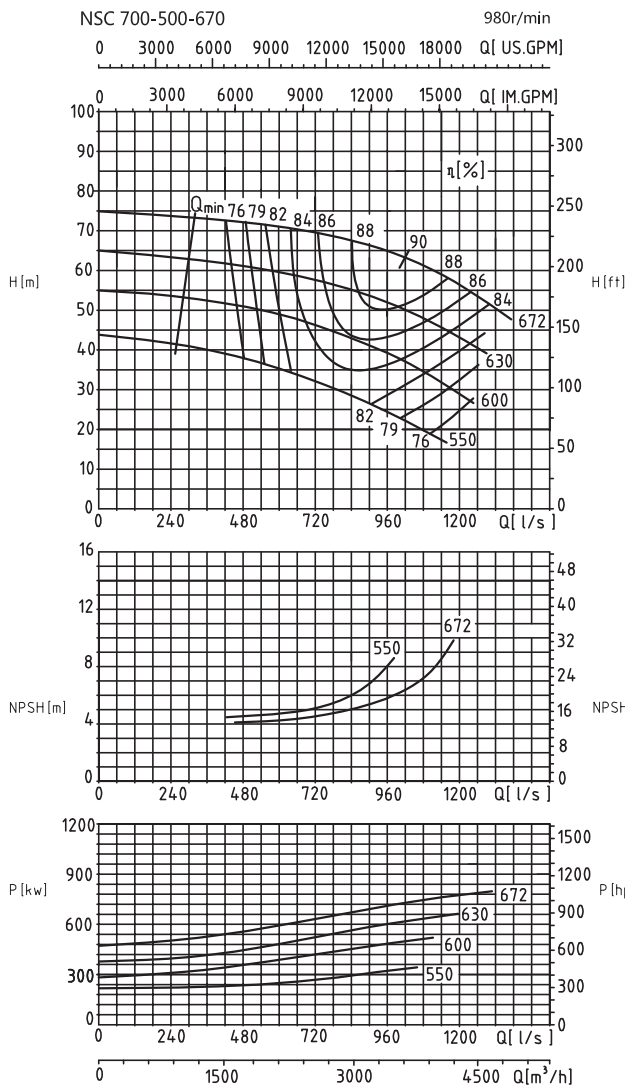

Модель	Производительность		Напор (м)	Скорость (r/min)	Мощность (kw)	Мощность на валу (kw)	КПД (%)	NPSHr (м)	Масса (kg)
	(m³/h)	(L/s)							
NSC700-500-670	3024	840.0	72.5	980	900	678.9	88	5.1	3000
	3740	1038.9	63			713.4	90	6.9	
	4320	1200.0	57			771.3	87	9.9	
NSC700-500-670A	2800	777.8	57		710	502.8	86.5	5.1	
	3410	947.2	52			542.9	89	6.5	
	3960	1100.0	47.5			596.0	86	10.2	
NSC700-500-670B	2600	722.2	47		560	394.1	84.5	5.0	
	3070	852.8	42			413.4	85	6.0	
	3700	1027.8	37.5			450.1	84	10.0	
NSC700-500-670C	2160	600.0	35		450	255.0	80.8	4.8	
	2750	763.9	31			279.9	83	5.6	
	3460	961.1	24.8			290.5	80.5	8.5	
NSC700-500-670L	2722	756.0	72.5	800	611.0	88	5.1		
	3366	935.0	63		642.1	90	6.9		
	3888	1080.0	57		694.1	87	9.9		
NSC700-500-670LA	2520	700.0	57	630	452.5	86.5	5.1		
	3069	852.5	52		488.6	89	6.5		
	3564	990.0	47.5		536.4	86	10.2		
NSC700-500-670LB	2340	650.0	47	500	354.7	84.5	5.0		
	2763	767.5	42		372.0	85	6.0		
	3330	925.0	37.5		405.1	84	10.0		
NSC700-500-670LC	1944	540.0	35	400	229.5	80.8	4.8		
	2475	687.5	31		251.9	83	5.6		
	3114	865.0	24.8		261.4	80.5	8.5		

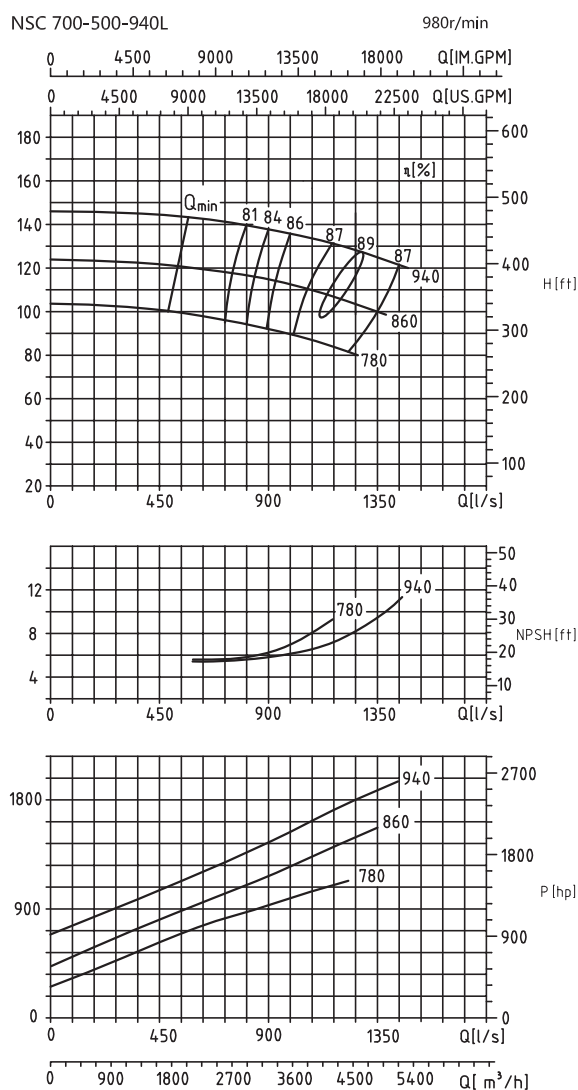
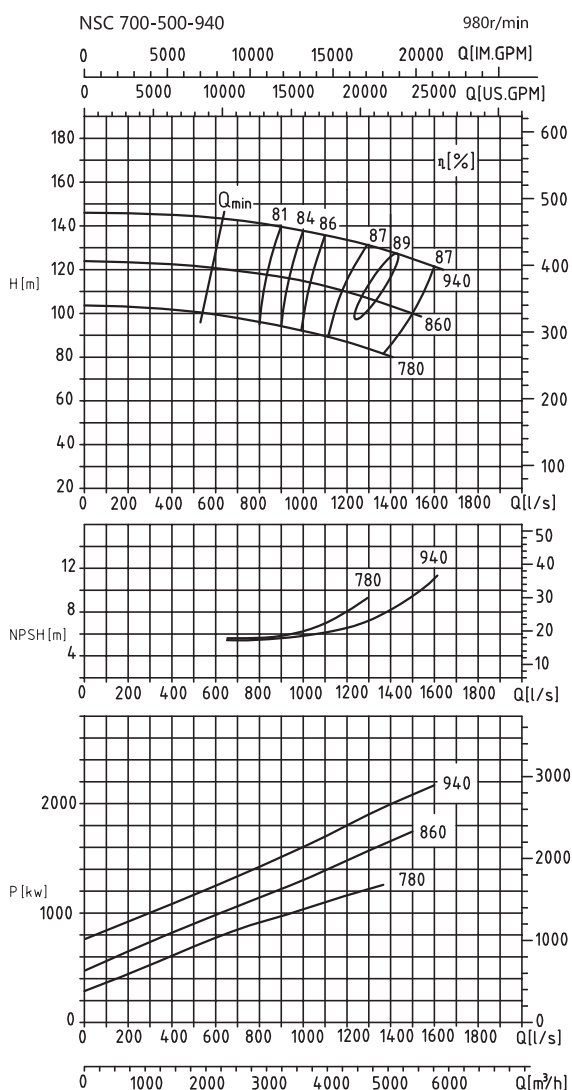

Модель	Производительность		Напор (м)	Скорость (r/min)	Мощность (kw)	Мощность на валу (kw)	КПД (%)	NPSHr (м)	Масса (kg)
	(m³/h)	(L/s)							
NSC700-500-940	4320	1200.0	133.6	980	2400	1818.2	86.5	6.7	4700
	5200	1444.4	127.2			2036.6	88.5	8.8	
	5400	1500.0	125			2090.2	88	9.4	
NSC700-500-940A	3960	1100.0	112.6		2000	1404.7	86.5	6.5	
	4664	1295.6	108			1545.7	88.8	8.1	
	5040	1400.0	103.6			1613.2	88.2	10.0	
NSC700-500-940B	3600	1000.0	82		1400	946.4	85	6.1	
	4230	1175.0	88.8			1176.5	87	8.0	
	4680	1300.0	83.8			1242.7	86	9.3	
NSC700-500-940L	3888	1080.0	133.6	2250	1636.4	86.5	6.7		
	4680	1300.0	127.2		1833.0	88.5	8.8		
	4860	1350.0	125		1881.2	88	9.4		
NSC700-500-940LA	3564	990.0	112.6	1800	1264.2	86.5	6.5		
	4198	1166.0	108		1391.2	88.8	8.1		
	4536	1260.0	103.6		1451.9	88.2	10.0		
NSC700-500-940LB	3240	900.0	82	1400	851.7	85	6.1		
	3807	1057.5	88.8		1058.9	87	8.0		
	4212	1170.0	83.8		1118.4	86	9.3		

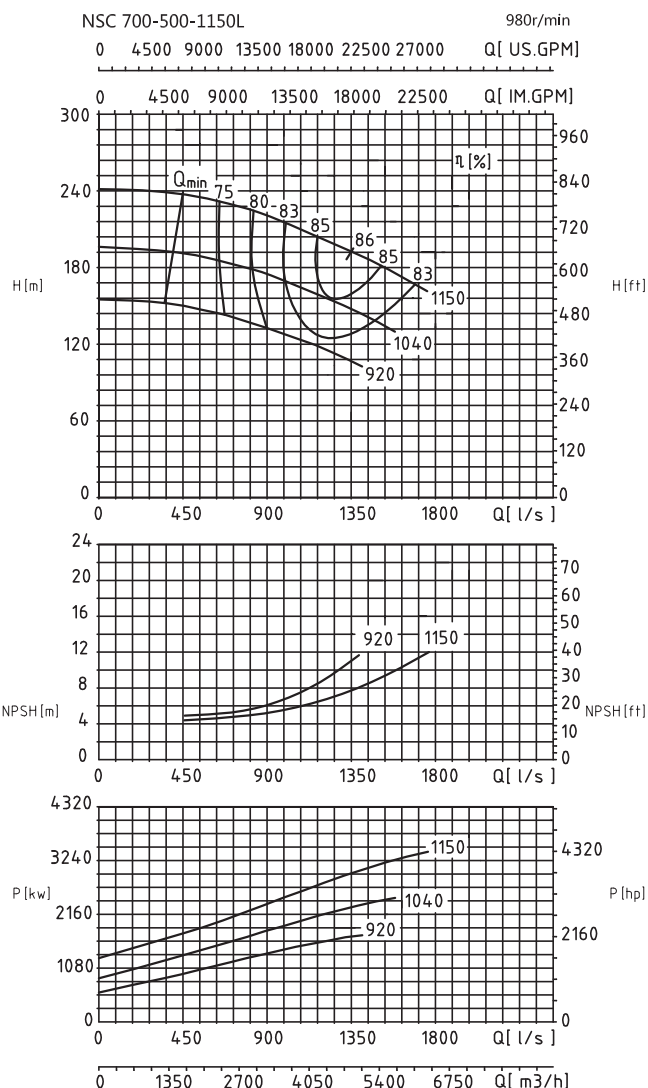
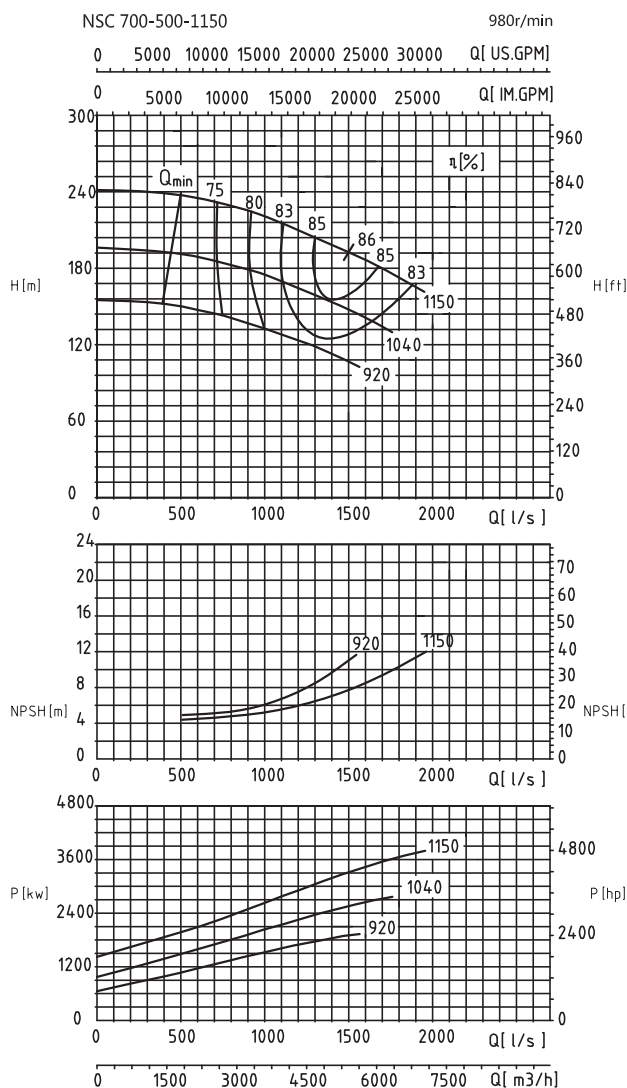

Модель	Производительность		Напор (m)	Скорость (r/min)	Мощность (kw)	Мощность на валу (kw)	КПД (%)	NPSHr (m)	Масса (kg)
	(m ³ /h)	(L/s)							
NSC700-500-1150	3960	1100.0	216	980	4000	2808.3	83	5.6	7900
	5400	1500.0	192			3285.2	86	7.9	
	6480	1800.0	170			3573.6	84	10.3	
NSC700-500-1150A	3240	900.0	180		3150	1986.5	80	5.5	
	4680	1300.0	158			2398.8	84	7.2	
	5650	1569.4	144			2671.2	83	10.5	
NSC700-500-1150B	3240	900.0	137		2500	1531.1	79	5.8	
	4320	1200.0	123			1787.6	81	7.5	
	5040	1400.0	113			1939.9	80	9.8	
NSC700-500-1150L	3564	990.0	216	4000	2527.4	83	5.6		
	4860	1350.0	192		2956.7	86	7.9		
	5832	1620.0	170		3216.3	84	10.3		
NSC700-500-1150LA	2916	810.0	180	2800	1787.9	80	5.5		
	4212	1170.0	158		2158.9	84	7.2		
	5085	1412.5	144		2404.0	83	10.5		
NSC700-500-1150LB	2916	810.0	137	2250	1378.0	79	5.8		
	3888	1080.0	123		1608.8	81	7.5		
	4536	1260.0	113		1745.9	80	9.8		

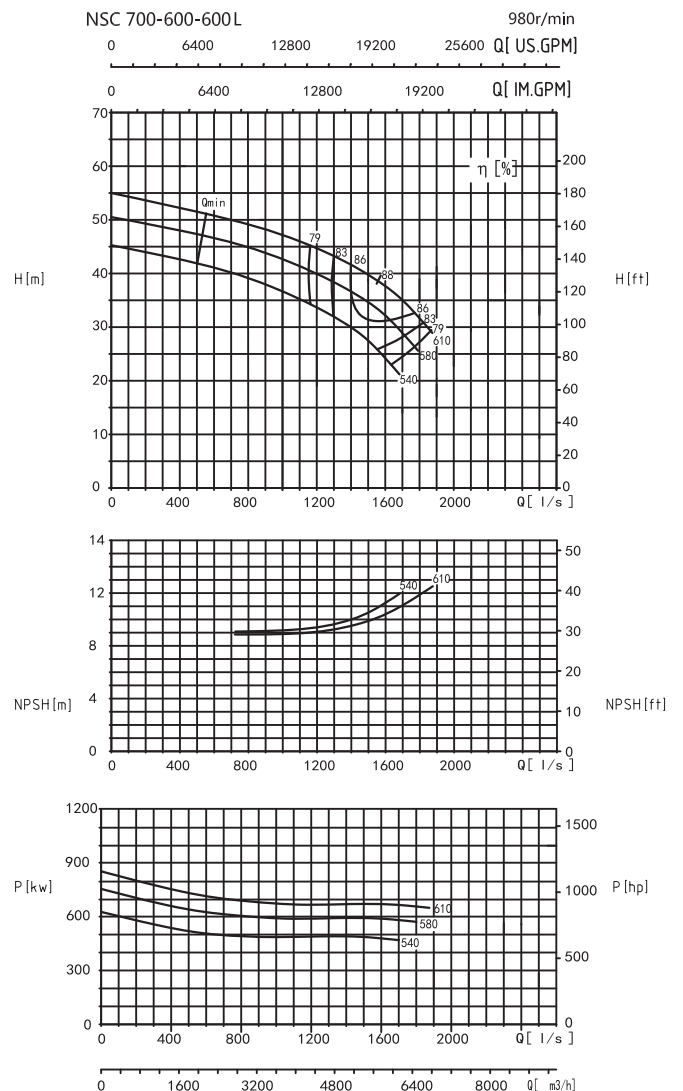
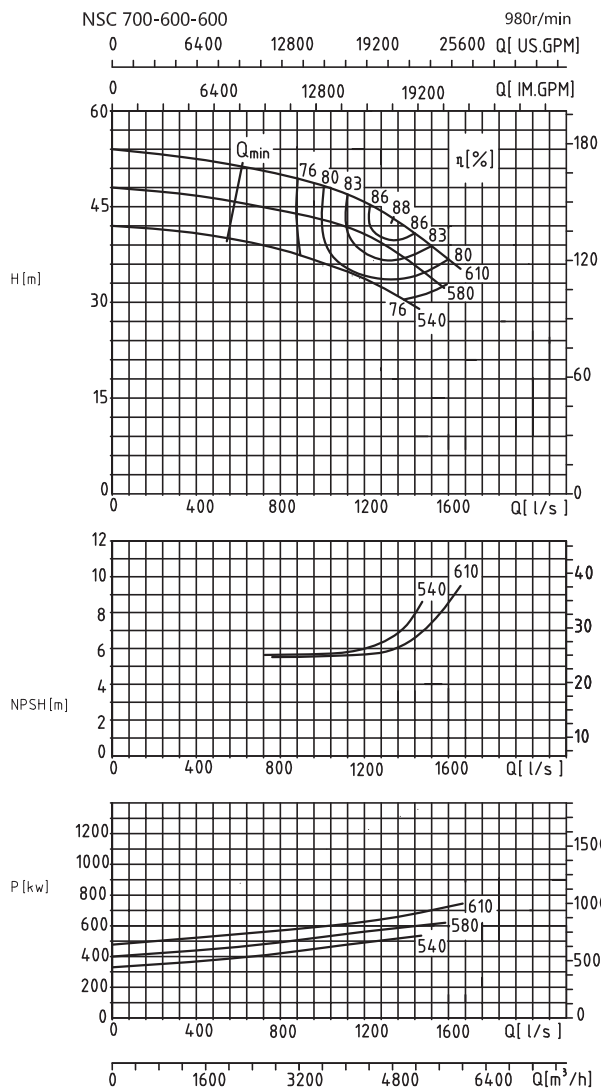

Модель	Производительность		Напор (m)	Скорость (r/min)	Мощность (kw)	Мощность на валу (kw)	КПД (%)	NPSHr (m)	Масса (kg)
	(m³/h)	(L/s)							
NSC700-600-600	3744	1040.0	48	980	900	597.2	82	5.6	3000
	4800	1333.3	43.2			642.1	88	6.0	
	5600	1555.6	38			714.1	81.2	8.0	
NSC700-600-600A	3600	1000.0	41		800	502.8	80	5.7	
	4608	1280.0	39.5			583.5	85	6.0	
	5328	1480.0	34.6			627.9	80	8.1	
NSC700-600-600B	3456	960.0	36.6		630	447.6	77	5.8	
	4140	1150.0	34.3			483.7	80	5.9	
	4896	1360.0	31			537.1	77	7.1	
NSC700-600-600L	4700	1305.6	48	800	663.5	83	9.2		
	5600	1555.6	38.5		667.6	88	10.2		
	6350	1763.9	33		664.0	86	11.6		
NSC700-600-600LA	4650	1291.7	38.5	710	587.8	83	9.5		
	5400	1500.0	34.5		583.5	87	10.5		
	6000	1666.7	30		583.9	84	11.5		
NSC700-600-600LB	4480	1244.4	33	560	491.3	82	9.5		
	5150	1430.6	29.3		489.5	84	10.2		
	5650	1569.4	25		469.4	82	11.0		

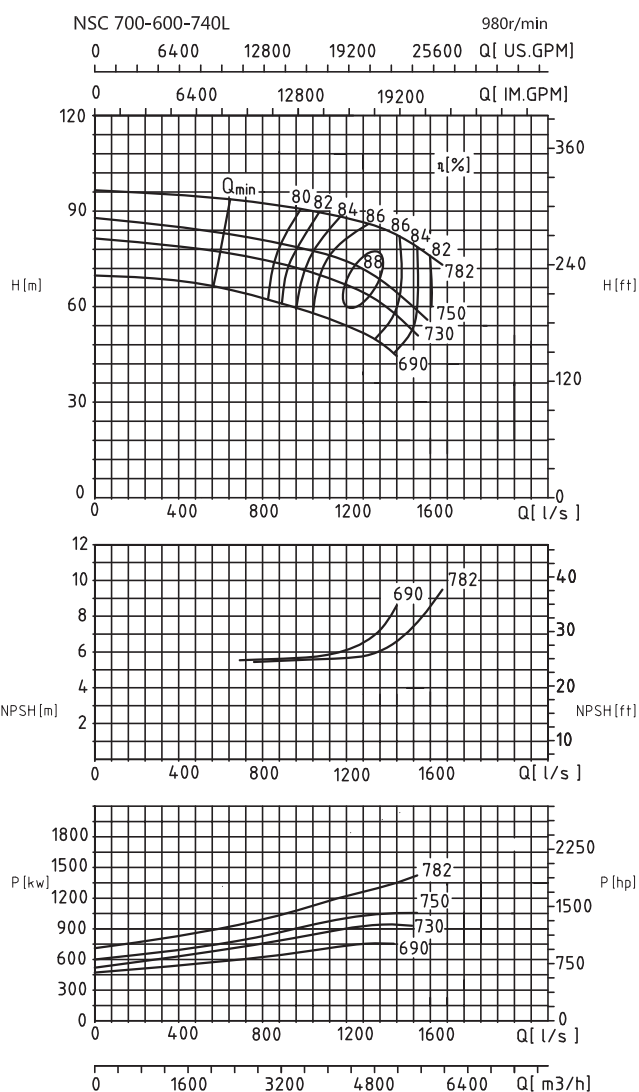
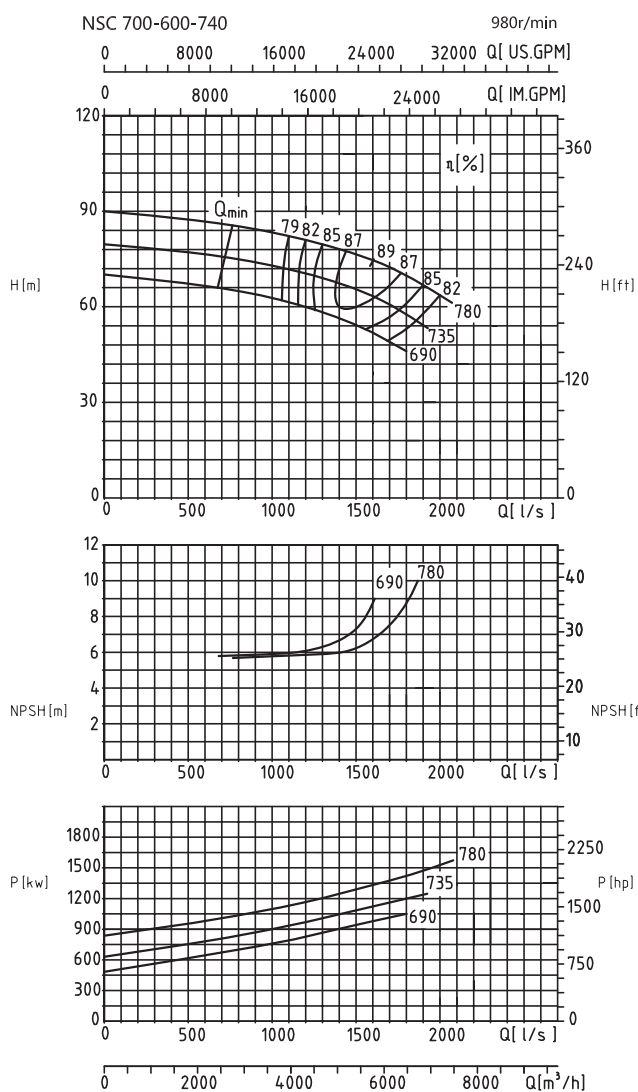

Модель	Производительность		Напор (m)	Скорость (r/min)	Мощность (kw)	Мощность на валу (kw)	КПД (%)	NPSHr (m)	Масса (kg)
	(m ³ /h)	(L/s)							
NSC700-600-740	5000	1388.9	78	980	1600	1235.8	86	6	4100
	5750	1597.2	75			1320.4	89	6.7	
	6500	1805.6	69.6			1433.5	86	8.8	
NSC700-600-740A	4500	1250.0	70		1400	1009.9	85	6.1	
	5250	1458.3	66			1073.0	88	6.5	
NSC700-600-740B	6000	1666.7	61.3		1120	1165.4	86	8.5	
	4500	1250.0	59.5			858.4	85	6.2	
NSC700-600-740C	5000	1388.9	57		1274.7	903.1	86	6.7	
	5500	1527.8	53.8			948.6	85	7.6	
NSC700-600-740D	4660	1294.4	86.43	1274.7	1274.7	86.1	5.9		
	5000	1388.9	85		1316.1	88	6.3		
NSC700-600-740E	5228	1452.2	80	1322.2	1322.2	86.2	7.1		
	4475.8	1243.3	74		1025.6	88	6.0		
	4840	1344.4	72		1067.0	89	6.5		
NSC700-600-740F	4929.8	1369.4	68.5	1045.7	1045.7	88	6.8		
	4032	1120.0	67.3		852.9	86.7	5.8		
	4590	1275	65		913.5	89	6.3		
NSC700-600-740G	4752	1320	62.3	918.8	918.8	87.8	6.6		
	3744	1040	58		688.1	86	5.8		
	4100	1138.9	56.5		717.3	88	5.9		
NSC700-600-740H	4608	1280.0	52.7	760.6	760.6	87	6.6		

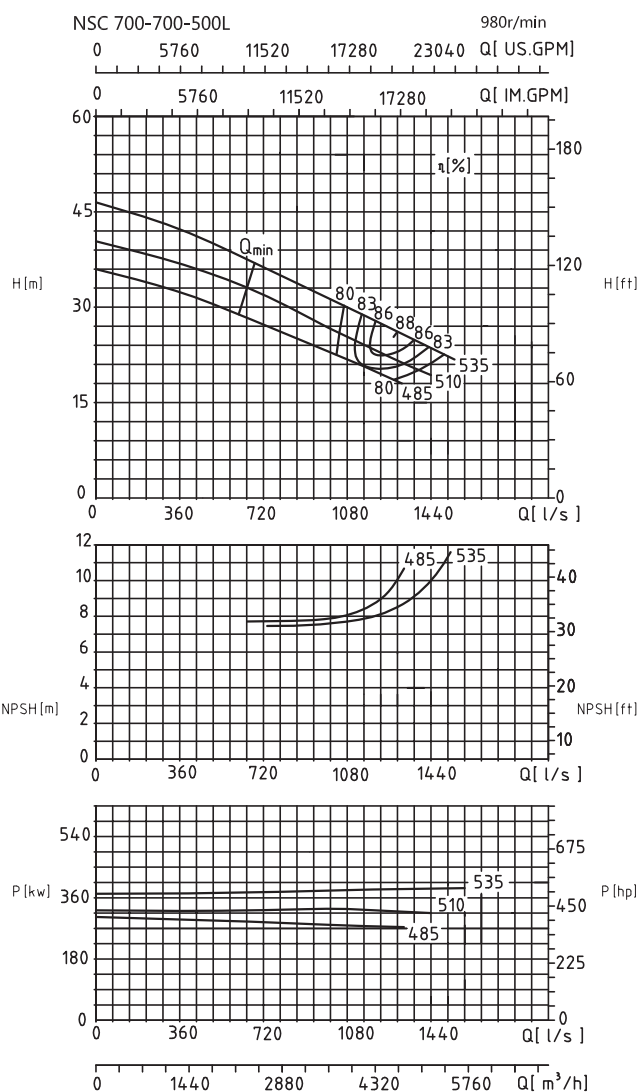
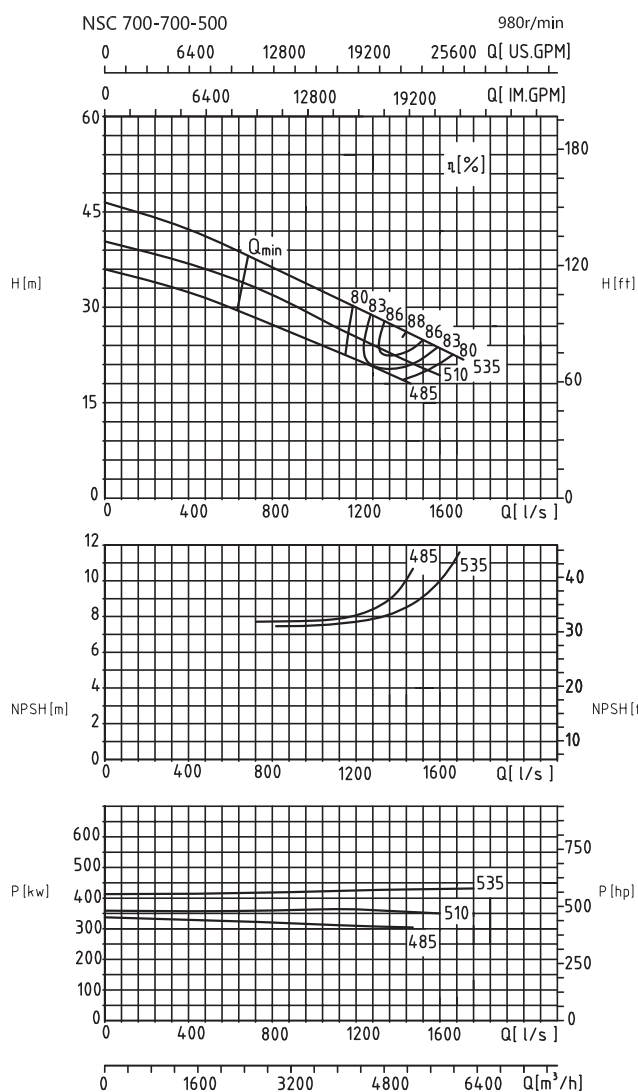

Модель	Производительность		Напор (м)	Скорость (r/min)	Мощность (kw)	Мощность на валу (kw)	КПД (%)	NPSHr (m)	Масса (kg)
	(m ³ /h)	(L/s)							
NSC700-700-500	4800	1333.3	28	980	500	425.9	86	8.0	3300
	5200	1444.4	26			418.7	88	8.6	
	5600	1555.6	24.2			439.6	84	9.6	
NSC700-700-500A	4400	1222.2	25		400	370.1	81	7.8	
	4800	1333.3	23.2			352.9	86	8.3	
	5200	1444.4	21.5			362.7	84	9.5	
NSC700-700-500B	4200	1166.7	22.1		355	316.2	80	8.0	
	4600	1277.8	20.6			314.9	82	8.4	
	5000	1388.9	19			319.6	81	9.4	
NSC700-700-500L	4320	1200.0	28	500	383.3	86	8.0		
	4680	1300.0	26		376.8	88	8.6		
	5040	1400.0	24.2		395.7	84	9.6		
NSC700-700-500LA	3960	1100.0	25	400	333.1	81	7.8		
	4320	1200.0	23.2		317.6	86	8.3		
	4680	1300.0	21.5		326.4	84	9.5		
NSC700-700-500LB	3780	1050.0	22.1	355	284.6	80	8.0		
	4140	1150.0	20.6		283.4	82	8.4		
	4500	1250.0	19		287.6	81	9.4		

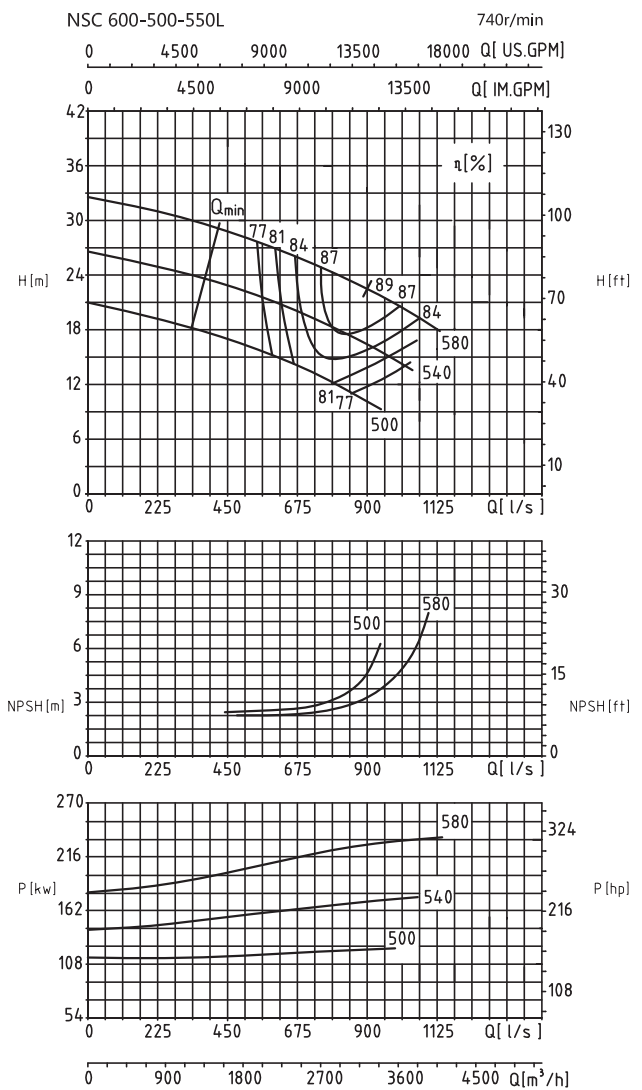
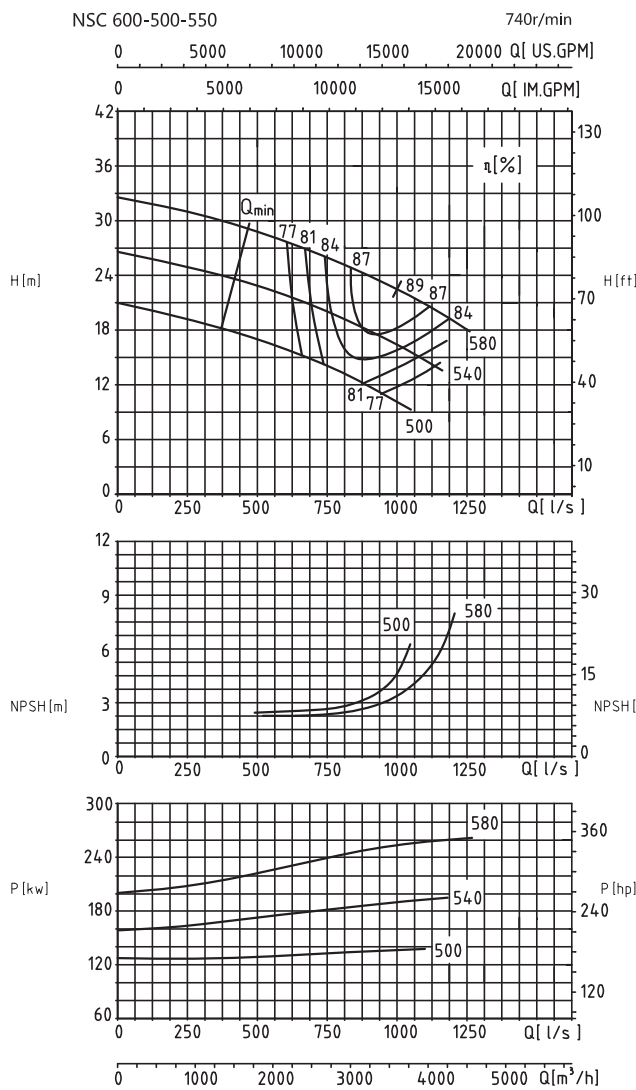

Модель	Производительность		Напор (m)	Скорость (r/min)	Мощность (kw)	Мощность на валу (kw)	КПД (%)	NPSHr (m)	Масса (kg)
	(m³/h)	(L/s)							
NSC600-500-550	2925	812.5	25.2	740	315	232.7	86.3	2.5	2540
	3600	1000.0	22.6			249.1	89	3.5	
	4050	1125.0	20.5			260.6	86.8	5.3	
NSC600-500-550A	2700	750.0	21.1		220	185.5	83.7	2.6	
	3330	925.0	17.8			185.7	87	3.4	
	3600	1000.0	16.4			189.7	84.8	4.3	
NSC600-500-550B	2475	687.5	15		185	128.9	78.5	2.6	
	3100	861.1	13.2			136.0	82	3.1	
	3375	937.5	11.2			132.9	77.5	3.9	
NSC600-500-550L	2633	731.3	25.2	280	209.5	86.3	2.5		
	3240	900.0	22.6		224.2	89	3.5		
	3645	1012.5	20.5		234.6	86.8	5.3		
NSC600-500-550LA	2430	675.0	21.1	220	166.9	83.7	2.6		
	2997	832.5	17.8		167.1	87	3.4		
	3240	900.0	16.4		170.7	84.8	4.3		
NSC600-500-550LB	2228	618.8	15	160	116.0	78.5	2.6		
	2790	775.0	13.2		122.4	82	3.1		
	3038	843.8	11.2		119.6	77.5	3.9		

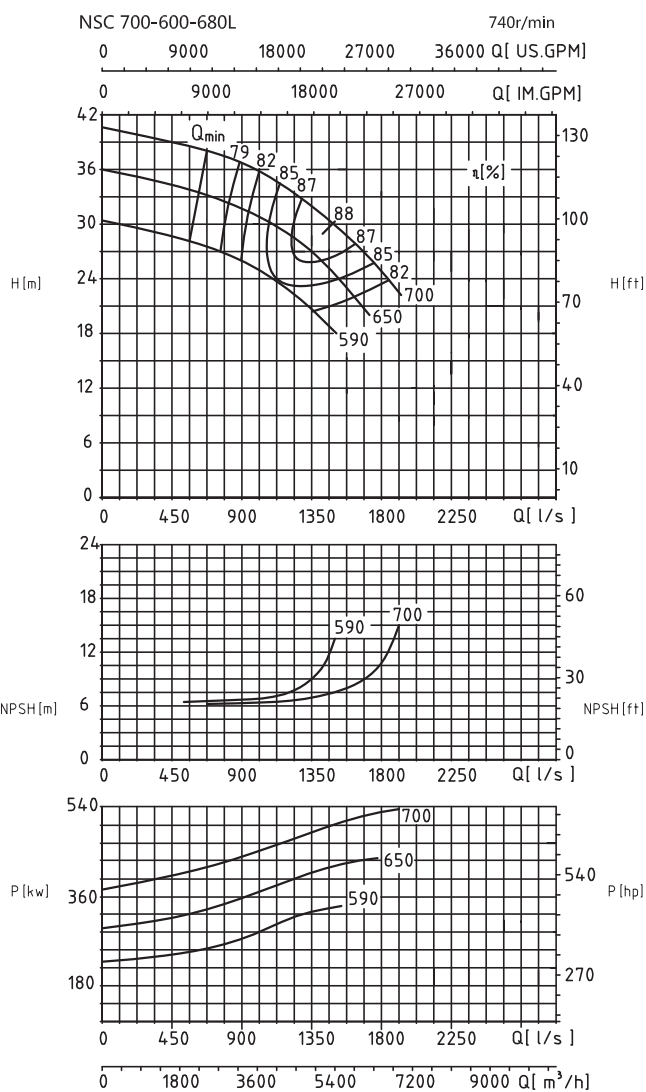
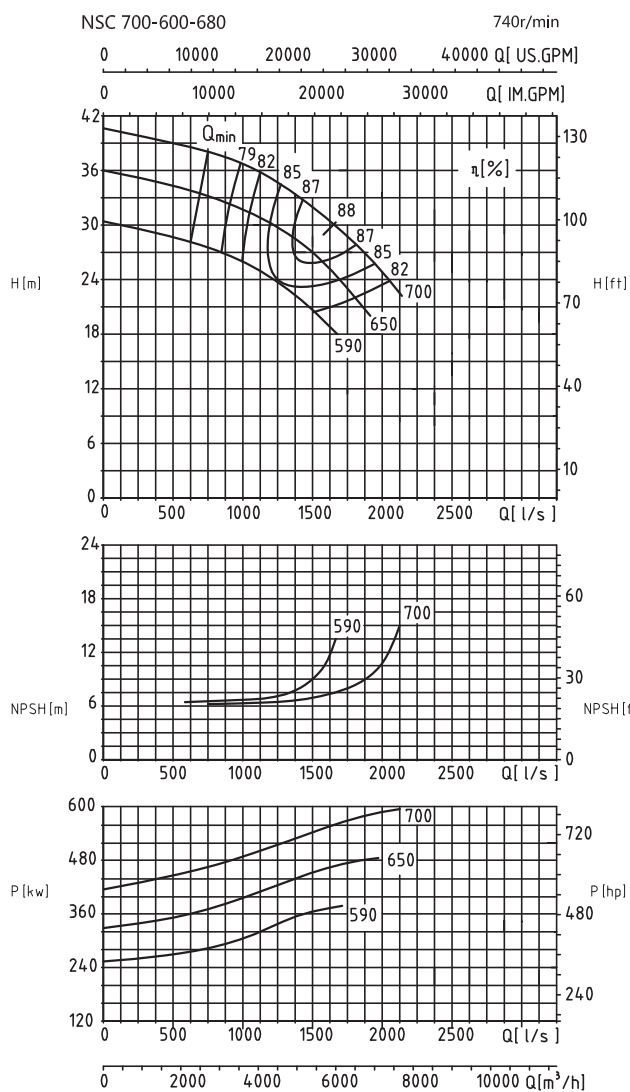

Модель	Производительность		Напор (m)	Скорость (r/min)	Мощность (kw)	Мощность на валу (kw)	КПД (%)	NPSHr (m)	Масса (kg)
	(m ³ /h)	(L/s)							
NSC700-600-680	5000	1388.9	33.5	740	710	530.7	86	6.7	3600
	6000	1666.7	30			557.4	88	7.5	
	7000	1944.4	25.8			585.9	84	9.7	
NSC700-600-680A	4500	1250.0	29.7		560	423.5	86	6.7	
	5500	1527.8	26.7			460.0	87	8.3	
	6500	1805.6	22			475.2	82	11.0	
NSC700-600-680B	4000	1111.1	25		450	328.3	83	6.7	
	5000	1388.9	22			356.8	84	7.8	
	5500	1527.8	20.3			371.0	82	9.3	
NSC700-600-680L	4500	1250.0	33.5	710	477.7	86	6.7		
	5400	1500.0	30		501.6	88	7.5		
NSC700-600-680LA	6300	1750.0	25.8		527.3	84	9.7		
	4050	1125.0	29.7		381.1	86	6.7		
NSC700-600-680LB	4950	1375.0	26.7	560	414.0	87	8.3		
	5850	1625.0	22		427.7	82	11.0		
	3600	1000.0	25		295.5	83	6.7		
NSC700-600-680LB	4500	1250.0	22	450	321.2	84	7.8		
	4950	1375.0	20.3		333.9	82	9.3		

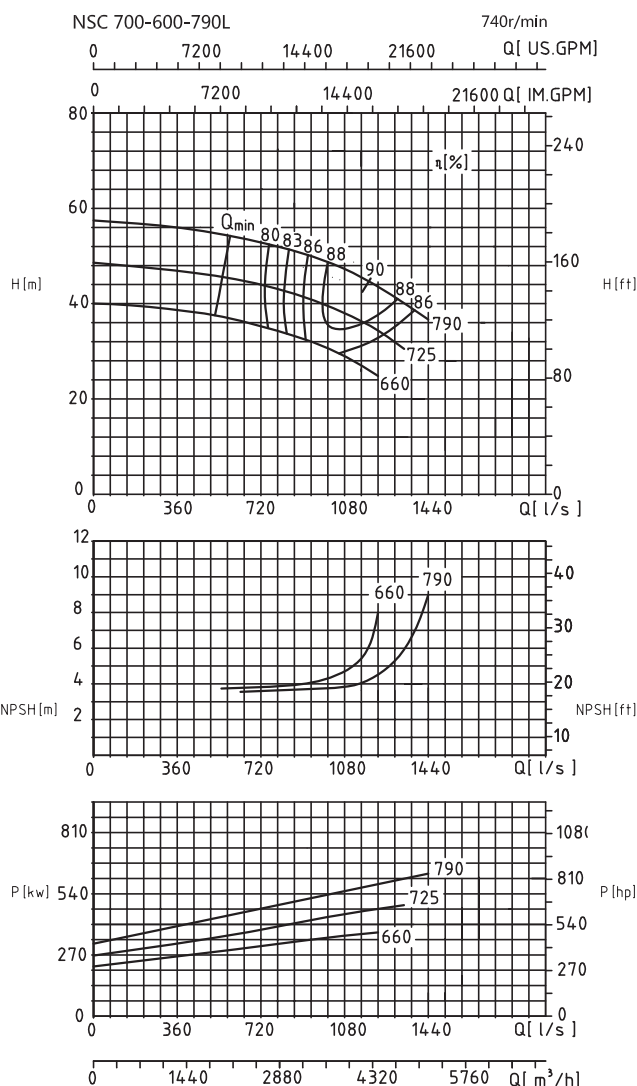
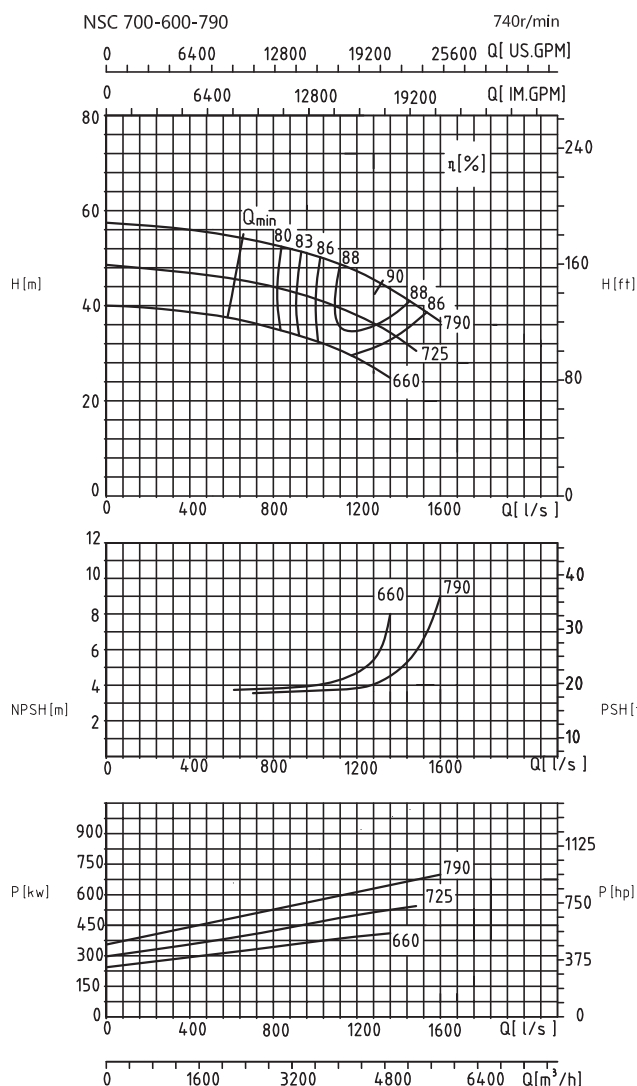

Модель	Производительность		Напор (м)	Скорость (r/min)	Мощность (kw)	Мощность на валу (kw)	КПД (%)	NPSHr (м)	Масса (kg)
	(m ³ /h)	(L/s)							
NSC700-600-790	3600	1000.0	50.5	740	800	582.8	85	3.7	4100
	4600	1277.8	45.5			640.8	89	4	
	5400	1500.0	39.7			671.5	87	6.2	
NSC700-600-790A	3400	944.4	42.2		630	465.5	84	3.8	
	4200	1166.7	38.7			503.3	88	4.2	
	5000	1388.9	31.8			503.8	86	5.5	
NSC700-600-790B	3200	888.9	34		500	361.6	82	3.9	
	3800	1055.6	32			385.3	86	4.1	
	4400	1222.2	28.5			406.8	84	4.9	
NSC700-600-790	3240	900.0	50.5	710	710	524.5	85	3.7	4100
	4140	1150.0	45.5			576.8	89	4	
	4860	1350.0	39.7			604.3	87	6.2	
NSC700-600-790LA	3060	850.0	42.2	560	418.9	84	3.8		
	3780	1050.0	38.7		453.0	88	4.2		
	4500	1250.0	31.8		453.4	86	5.5		
NSC700-600-790LB	2880	800.0	34	450	325.4	82	3.9		
	3420	950	32		346.8	86	4.1		
	3960	1100	28.5		366.1	84	4.9		

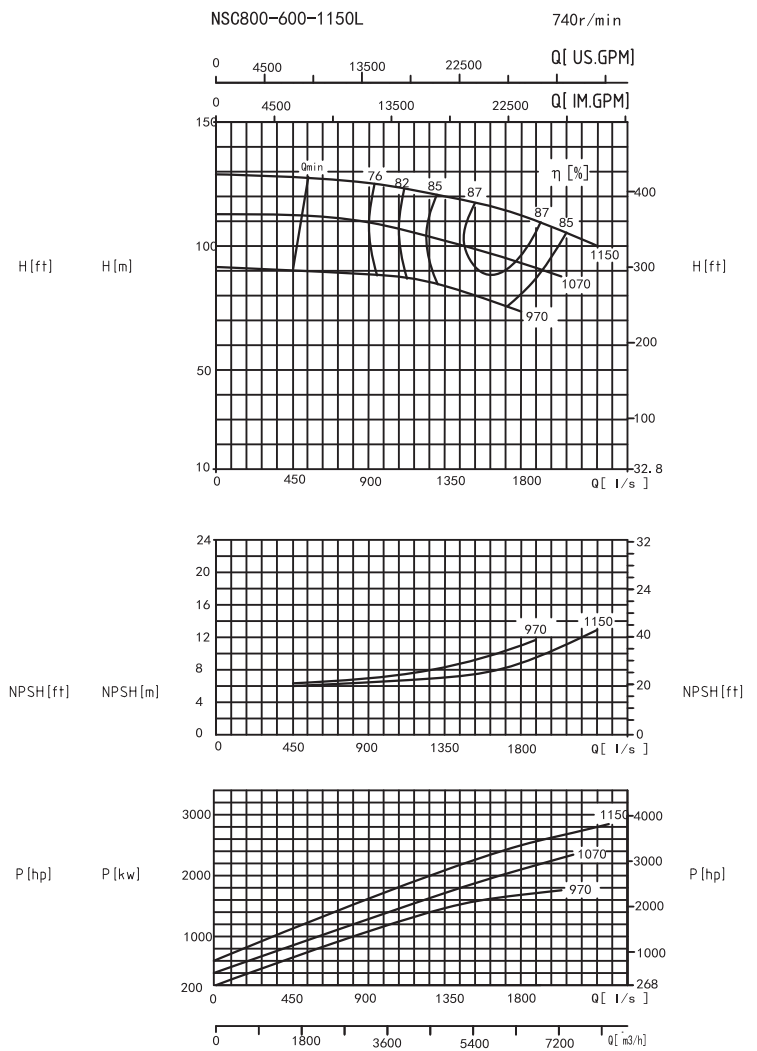
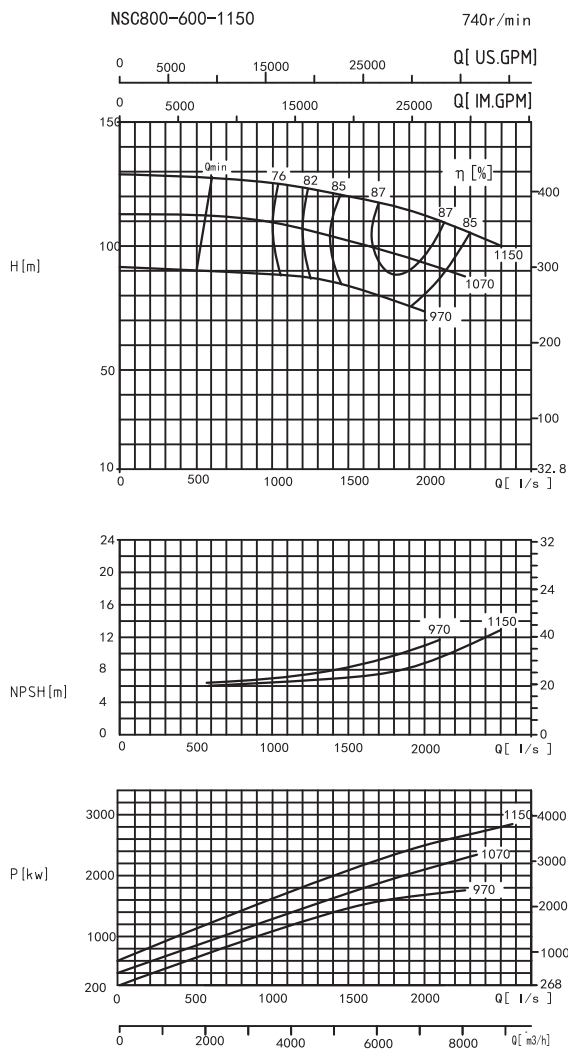

Модель	Производительность		Напор (м)	Скорость (r/min)	Мощность (kw)	Мощность на валу (kw)	КПД (%)	NPSHr (м)	Масса (kg)
	m ³ /h	L/s							
NSC800-600-1150	5000	1388.9	121	740	3150	1962.6	84	7.0	10000
	6500	1805.6	115			2314.7	88	8.5	
	8000	2222.2	106			2718.6	85	11.0	
NSC800-600-1150A	5000	1388.9	104		2500	1667.1	85	7.5	
	6400	1777.8	97			1922.4	88	9.0	
	7400	2055.6	91			2158.8	85	11.0	
NSC800-600-1150B	4600	1277.8	86		1800	1314.6	82	7.5	
	6000	1666.7	80			1520.9	86	9.0	
	6800	1888.9	76			1656.8	85	10.5	
NSC800-600-1150L	4500	1250.0	121	2800	1766.4	84	7.0		
	5850	1625.0	115		2083.2	88	8.5		
	7200	2000.0	106		2446.7	85	11.0		
NSC800-600-1150LA	4500	1250.0	104	2250	1500.4	85	7.5		
	5760	1600.0	97		1730.1	88	9.0		
	6660	1850.0	91		1943.0	85	11.0		
NSC800-600-1150LB	4140	1150.0	86	1800	1183.2	82	7.5		
	5400	1500.0	80		1368.8	86	9.0		
	6120	1700.0	76		1491.1	85	10.5		

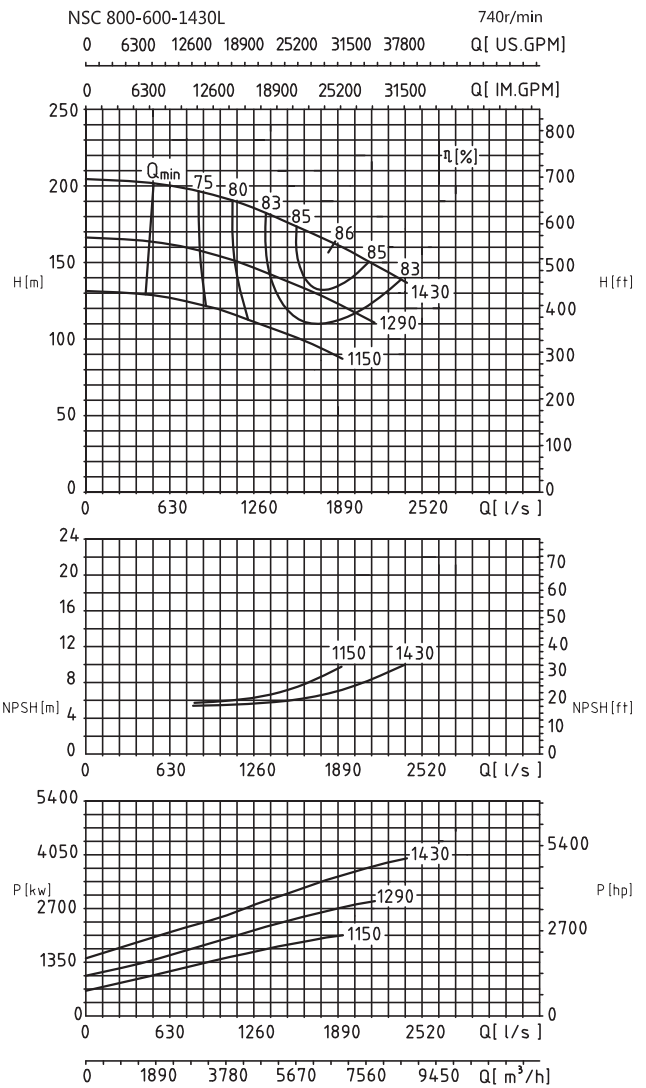
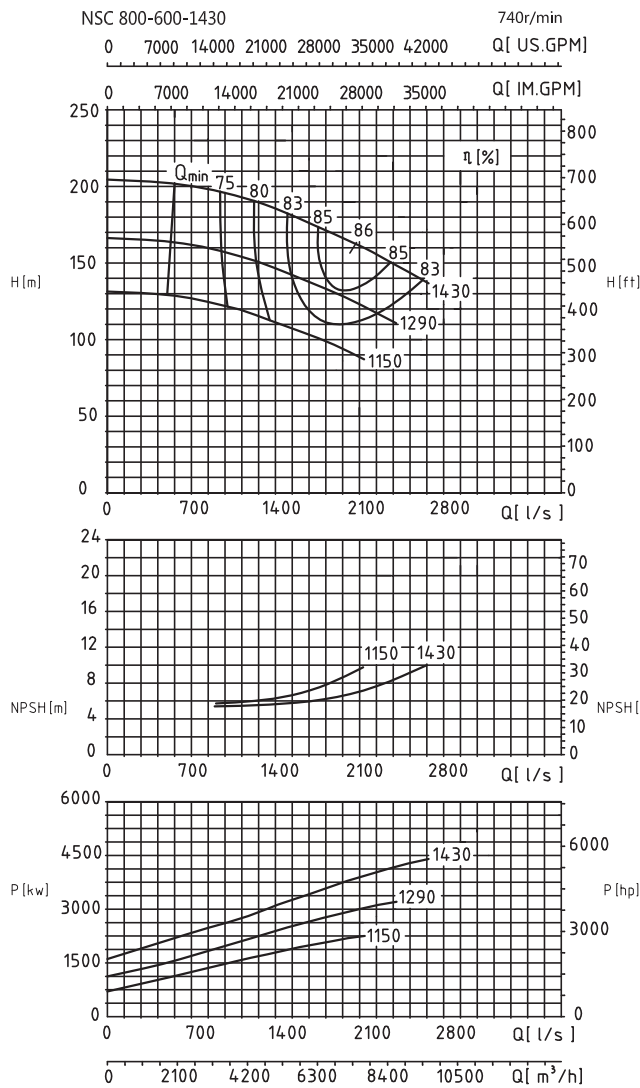

Модель	Производительность		Напор (м)	Скорость (r/min)	Мощность (kw)	Мощность на валу (kw)	КПД (%)	NPSHr (м)	Масса (kg)
	(m³/h)	(L/s)							
NSC800-600-1430	5400	1500.0	182	740	5000	3226.7	83	6.0	11300
	7380	2050.0	162			3788.3	86	6.8	
	9070	2519.4	143			4207.6	84	8.8	
NSC800-600-1430A	4570	1269.4	150		3550	2335.0	80	6.0	
	6050	1680.6	139			2728.1	84	6.8	
	7550	2097.2	122			3006.0	83.5	8.5	
NSC800-600-1430B	4000	1111.1	120		2800	1676.9	78	6.0	
	5540	1538.9	108			2012.9	81	6.9	
	6550	1819.4	99			2208.8	80	8.0	
NSC800-600-1430L	4860	1350.0	182	4500	2904.0	83	6.0		
	6642	1845.0	162		3409.4	86	6.8		
	8163	2267.5	143		3786.8	84	8.8		
NSC800-600-1430LA	4113	1142.5	150	3150	2101.5	80	6.0		
	5445	1512.5	139		2455.3	84	6.8		
	6795	1887.5	122		2705.4	83.5	8.5		
NSC800-600-1430LB	3600	1000.0	120	2400	1509.2	78	6.0		
	4986	1385.0	108		1811.6	81	6.9		
	5895	1637.5	99		1987.9	80	8.0		

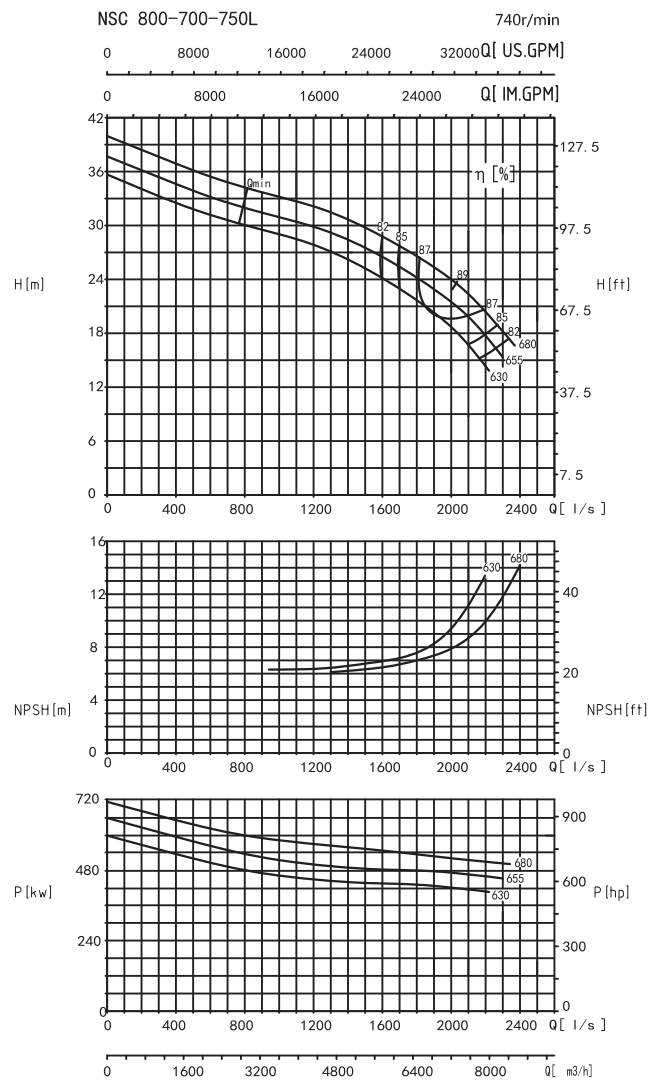
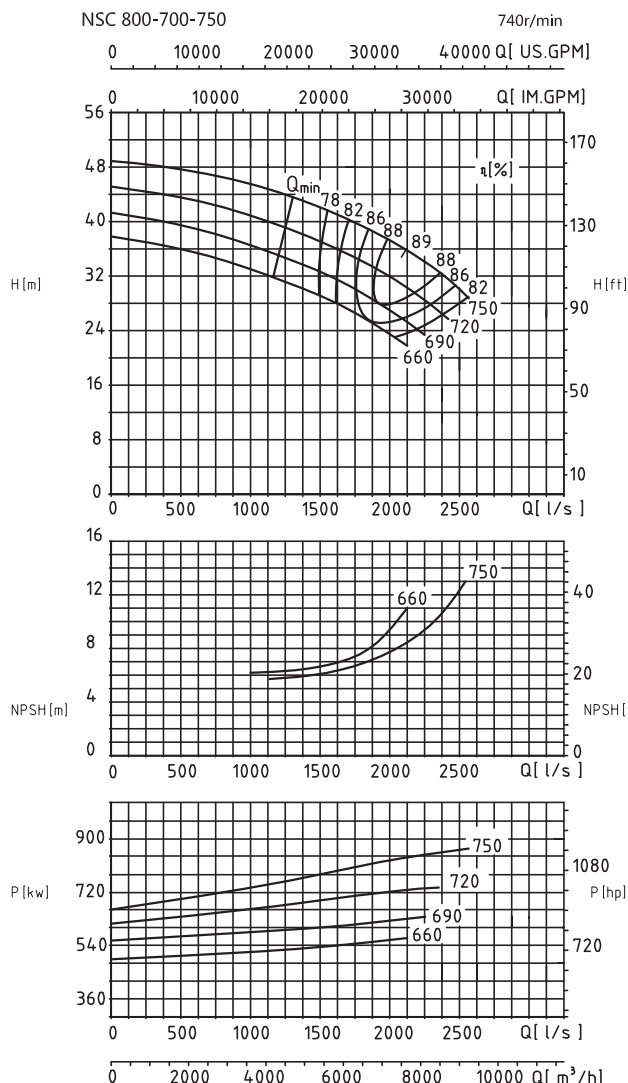

Модель	Производительность		Напор (м)	Скорость (r/min)	Мощность (kw)	Мощность на валу (kw)	КПД (%)	NPSHr (м)	Масса (kg)
	(m³/h)	(L/s)							
NSC800-700-750	6750	1875.0	38.2	740	1000	817.0	86	6.0	5040
	8226	2285.0	34			856.3	89	7.0	
	9000	2500.0	30			846.7	86.9	9.0	
NSC800-700-750A	6300	1750.0	33.8		800	679.5	85.4	4.5	
	7720	2144.4	29.8			720.6	87	7.0	
NSC800-700-750B	8438.4	2344.0	26		710	695.2	86	8.6	
	5850	1625.0	30.2			582.8	82.6	4.4	
NSC800-700-750C	7260	2016.7	25.7		630	598.2	85	5.8	
	7650	2125.0	22.1			549.8	83.8	6.7	
NSC800-700-750L	5591	1553.1	25		710	476.1	80	4.5	
	6775	1881.9	20	439.6		84	5.4		
	7200	2000.0	19.6	466.1		82.5	6.3		
NSC800-700-750LA	6100	1694.4	27.7	630	541.7	85	6.8		
	7300	2027.8	23.5		525.3	89	8.3		
	7900	219.4	20.5		507.3	87	9.9		
NSC800-700-750LB	6100	1694.4	25.5	560	498.7	85	7.0		
	7100	1972.2	22		483.7	88	8.5		
NSC800-700-750L	7700	2138.9	19	740	463.6	86	10.5		
	6100	1694.4	23		449.8	85	7.4		
	6900	1916.7	20		432.2	87	8.7		
NSC800-700-750L	7550	2097.2	16.8	560	406.6	85	11.0	5040	

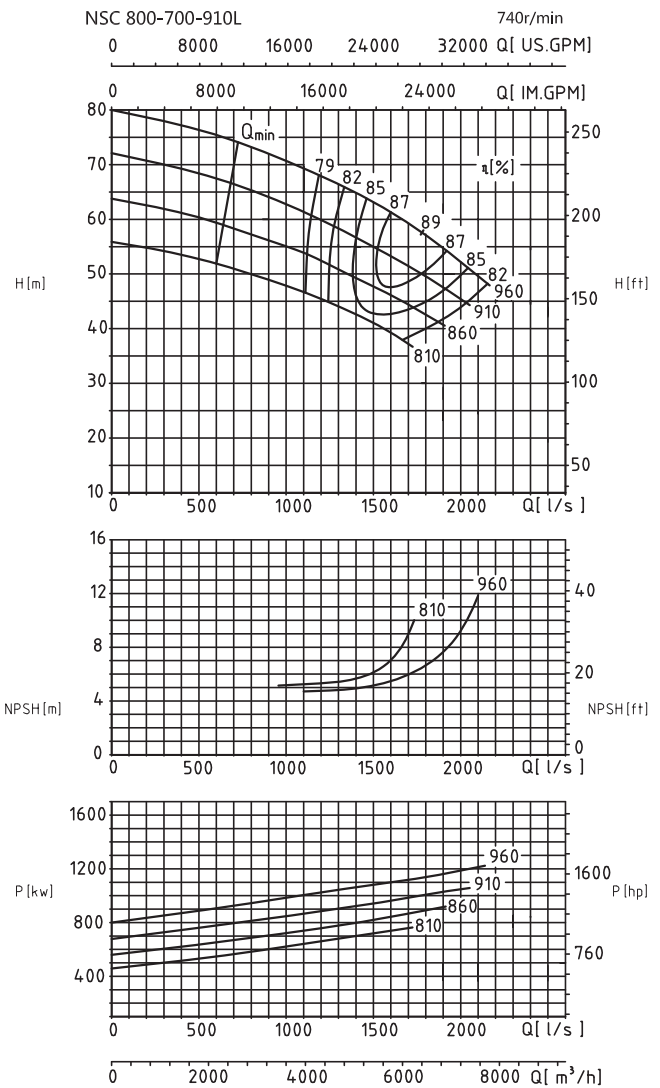
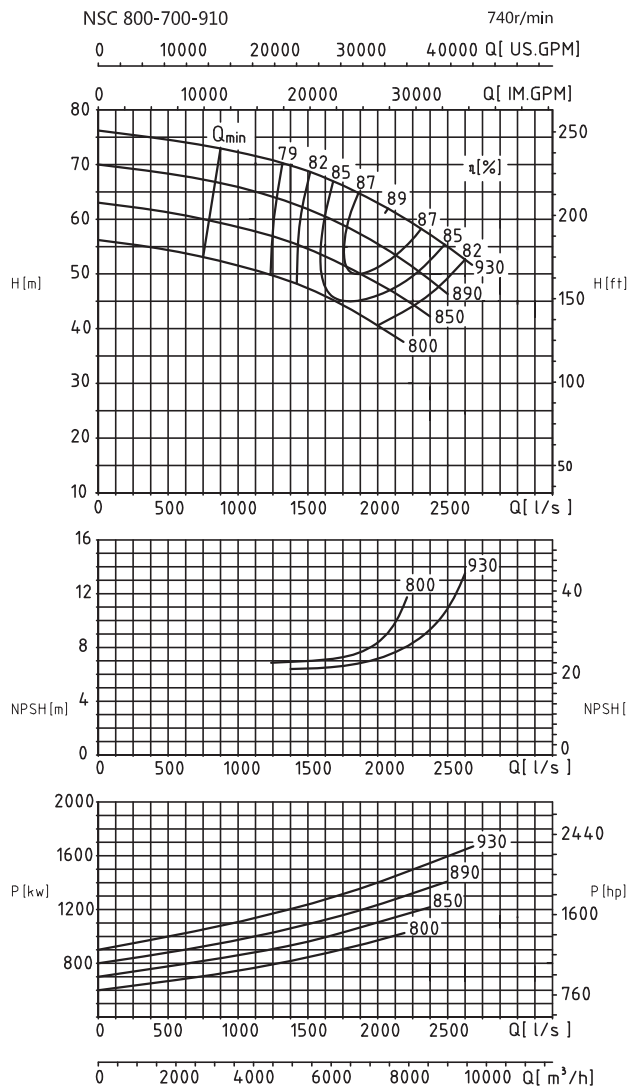

Модель	Производительность		Напор (м)	Скорость (r/min)	Мощность (kw)	Мощность на валу (kw)	КПД (%)	NPSHr (м)	Масса (kg)
	(m³/h)	(L/s)							
NSC800-700-910	6500	1805.6	65.5	740	1600	1349.0	86	6.8	6500
	7500	2083.3	62			1423.7	89	7.5	
	8500	2361.1	57.5			1548.7	86	9.2	
NSC800-700-910A	6000	1666.7	60		1400	1154.1	85	6.8	
	7000	1944.4	56.2			1218.2	88	7.5	
	8000	2222.2	52			1318.1	86	9.5	
NSC800-700-910B	5500	1527.8	54.2		1250	967.1	84	6.7	
	6500	1805.6	51			1038.3	87	7.0	
	7500	2083.3	47.2			1134.9	85	8.6	
NSC800-700-910C	5000	1388.9	48.5		1120	815.8	81	6.9	
	6000	1666.7	45.5			885.6	84	7.1	
	7000	1944.4	41.5			953.8	83	8.0	
NSC800-700-910L	5600	1555.6	62.1	1400	1101.9	86	5.4	6500	
	6400	1777.8	57.5		1126.7	89	6.5		
	7200	2000.0	52.1		1188.6	86	9.3		
NSC800-700-910LA	5200	1444.4	56	1250	933.6	85	5.5		
	6000	1666.7	52		966.1	88	6.5		
	6800	1888.9	47.8		1042.0	85	9.0		
NSC800-700-910LB	4800	1333.3	50.2	1000	781.7	84	5.2		
	5600	1555.6	47		834.0	86	6.0		
	6400	1777.8	43		892.8	84	8.8		
NSC800-700-910LC	4800	1333.3	43.8	900	690.2	83	5.5		6500
	5200	1444.4	42		708.5	84	5.8		
	6000	1666.7	38		757.7	82	8.0		

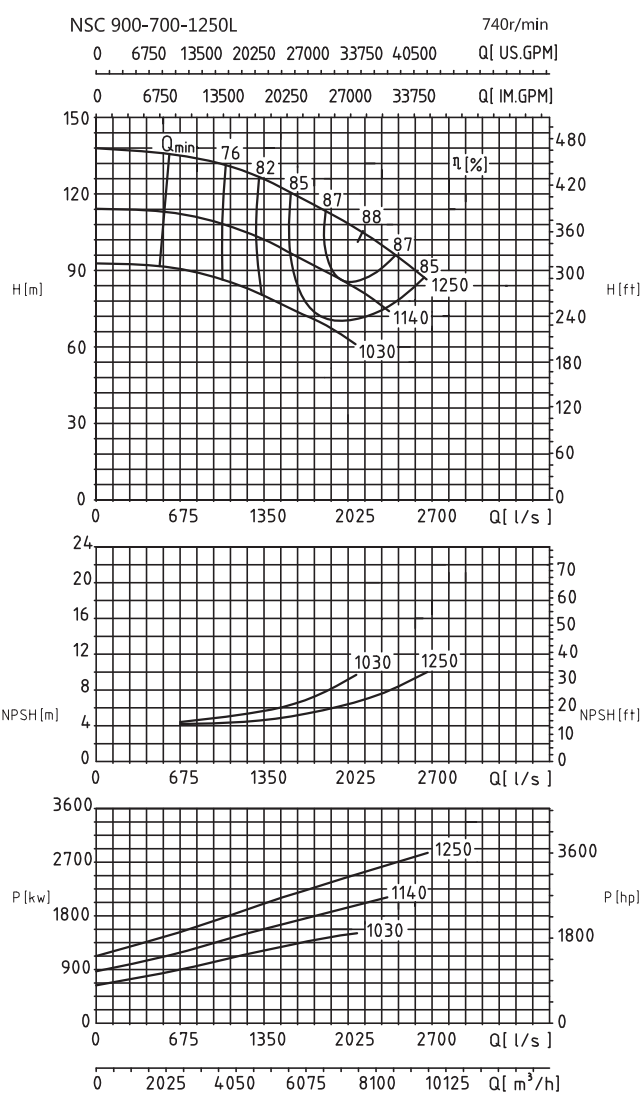
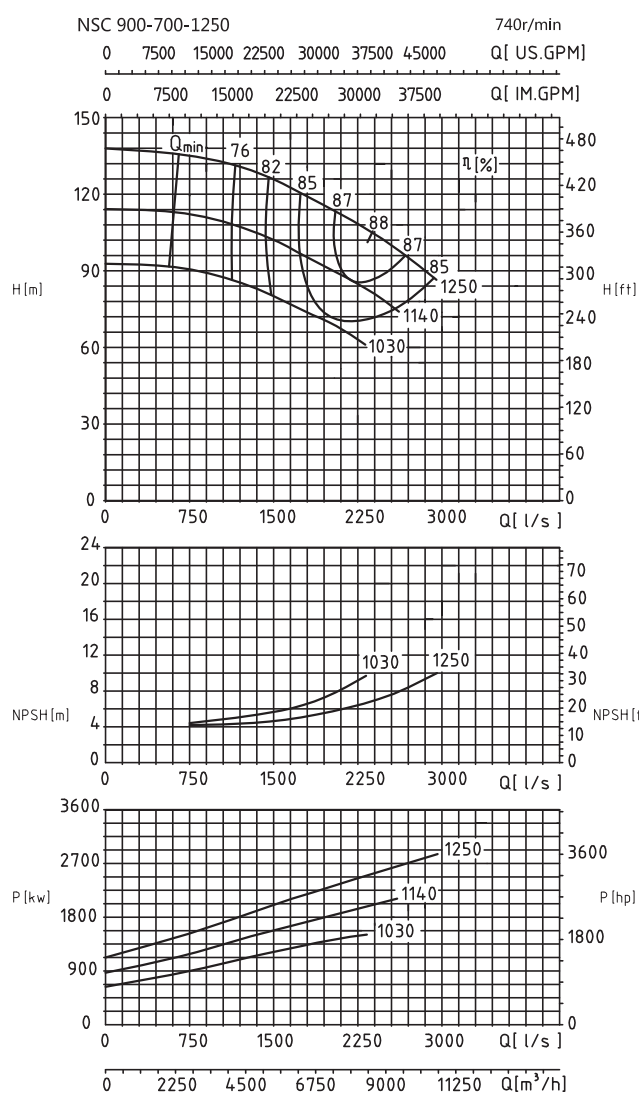

Модель	Производительность		Напор (m)	Скорость (r/min)	Мощность (kw)	Мощность на валу (kw)	КПД (%)	NPSHr (m)	Масса (kg)
	(m³/h)	(L/s)							
NSC900-700-1250	6300	1750.0	120	740	3550	2423.6	85	5.1	12500
	8600	2388.9	105			2796.2	88	6.8	
	9700	2694.4	96			2916.7	87	8.5	
NSC900-700-1250A	5400	1500.0	102		2800	1808.3	83	5.2	
	7020	1950.0	92			2046.4	86	6.5	
	8640	2400.0	81			2243.6	85	8.6	
NSC900-700-1250B	5040	1400.0	83		2240	1424.9	80	5.5	
	6480	1800.0	73			1534.6	84	6.8	
	7700	2138.9	66			1668.5	83	8.3	
NSC900-700-1250L	5670	1575.0	120	3150	2181.3	85	5.1		
	7740	2150.0	105		2516.6	88	6.8		
	8730	2425.0	96		2625.0	87	8.5		
NSC900-700-1250LA	4860	1350.0	102	2400	1627.5	83	5.2		
	6318	1755.0	92		1841.8	86	6.5		
	7776	2160.0	81		2019.2	85	8.6		
NSC900-700-1250LB	4536	1260.0	83	1800	1282.4	80	5.5		
	5832	1620.0	73		1381.1	84	6.8		
	6930	1925.0	66		1501.6	83	8.3		

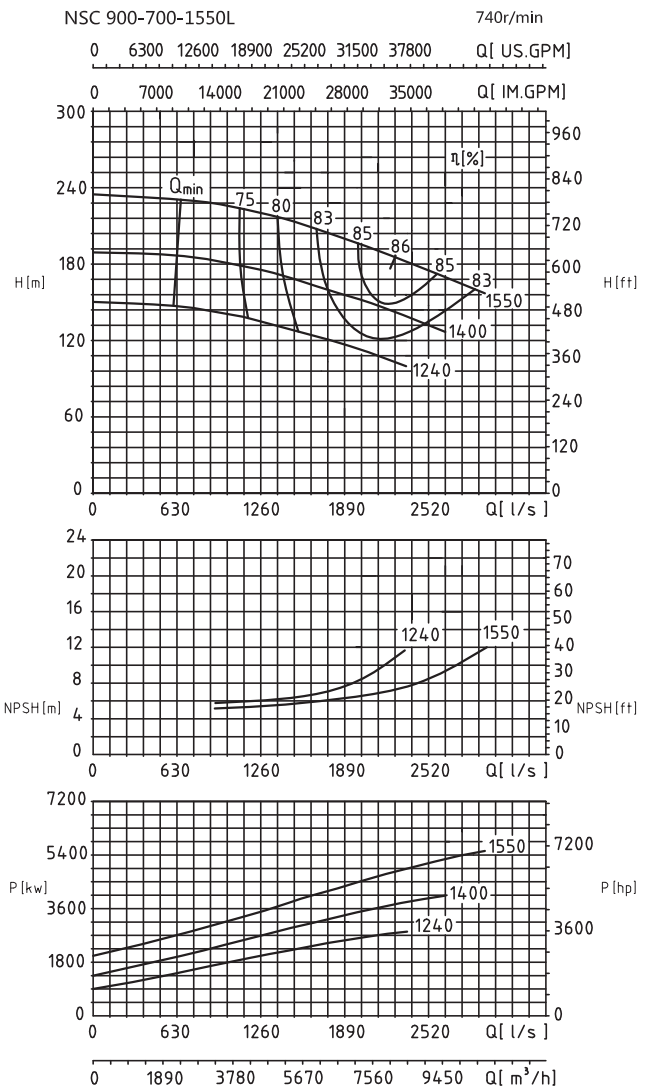
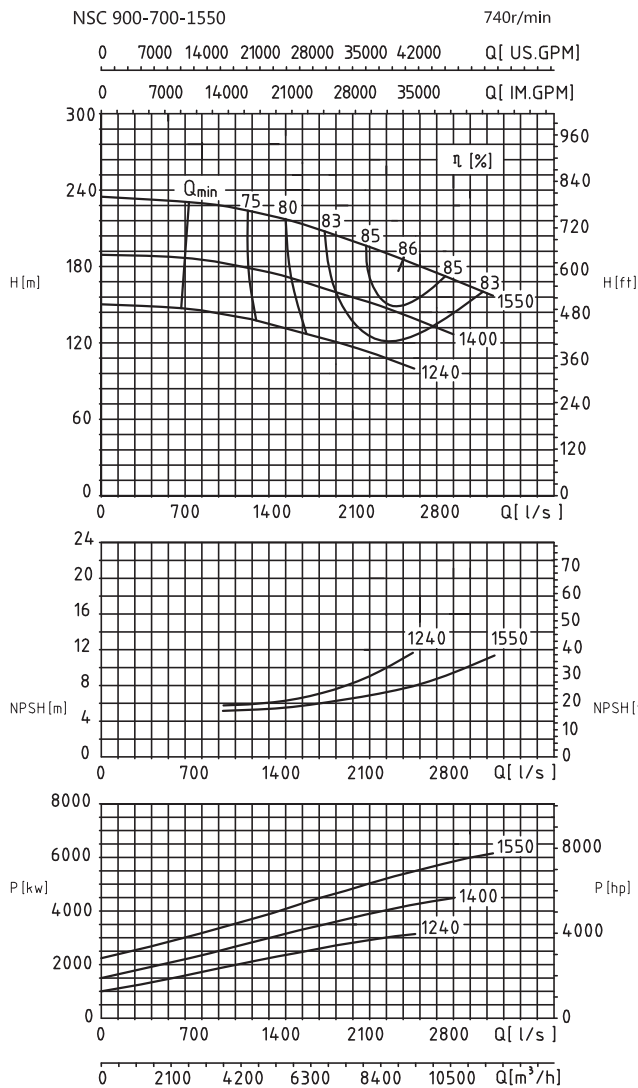

Модель	Производительность		Напор (м)	Скорость (r/min)	Мощность (kw)	Мощность на валу (kw)	КПД (%)	NPSHr (м)	Масса (kg)
	(m³/h)	(L/s)							
NSC900-700-1550	7050	1958.3	204	740	7100	4721.8	83	6.2	14300
	9070	2519.4	186			5345.5	86	7.8	
	10580	2938.9	169			5800.4	84	10.0	
NSC900-700-1550A	6550	1819.4	166		5000	3569.8	83	6.5	
	8060	2238.9	152			3881.9	86	8.0	
	9580	2661.1	137			4207.6	85	10.1	
NSC900-700-1550B	6050	1680.6	128		4000	2637.8	80	6.8	
	7560	2100.0	118			2964.5	82	8.1	
	8570	2380.6	108			3113.8	81	10.0	
NSC900-700-1550L	6345	1762.5	204	6300	4249.6	83	6.2		
	8163	2267.5	186		4810.9	86	7.8		
	9522	2645.0	169		5220.4	84	10.0		
NSC900-700-1550LA	5895	1637.5	166	5000	3212.8	83	6.5		
	7254	2015.0	152		3493.7	86	8.0		
	8622	2395.0	137		3786.8	85	10.1		
NSC900-700-1550LB	5445	1512.5	128	3550	2374.0	80	6.8		
	6804	1890.0	118		2668.1	82	8.1		
	7713	2142.5	108		2802.4	81	10.0		

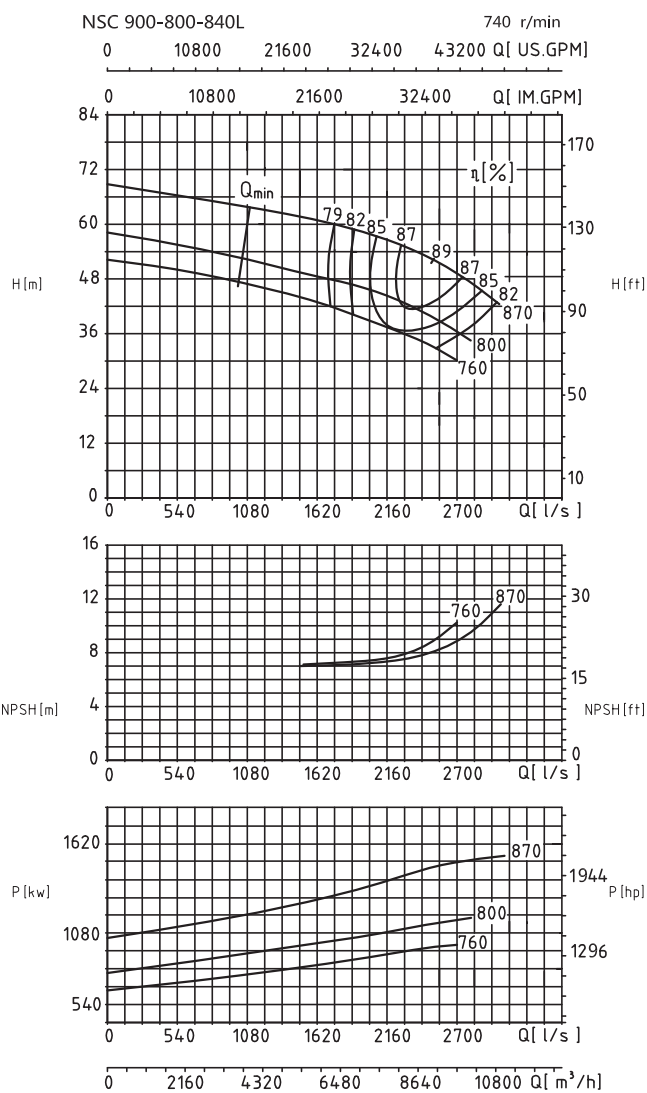
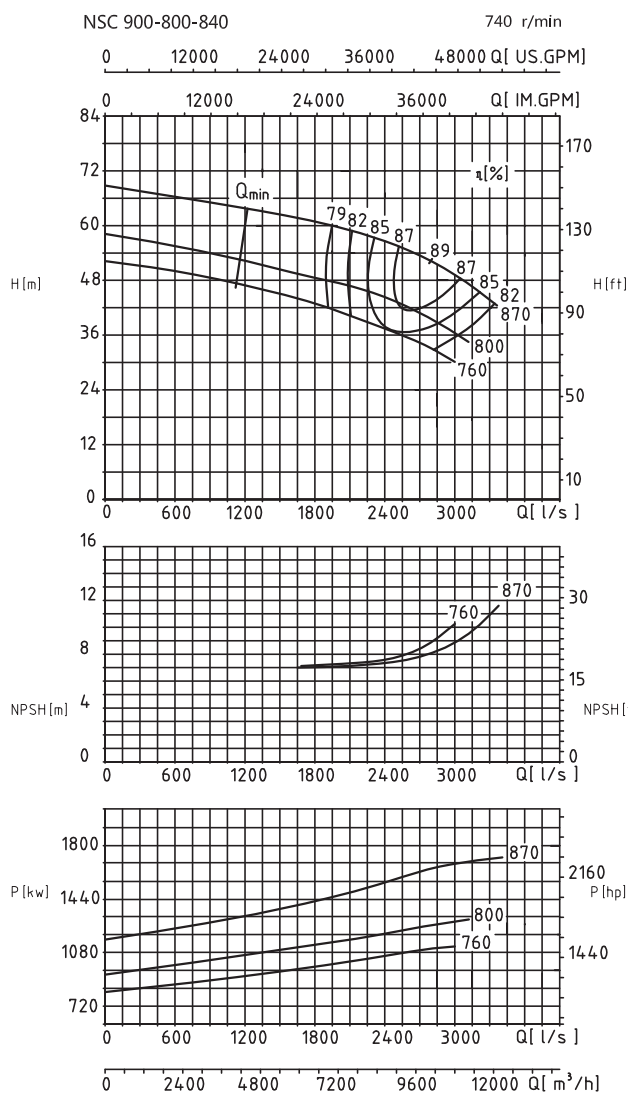

Модель	Производительность		Напор (м)	Скорость (r/min)	Мощность (kw)	Мощность на валу (kw)	КПД (%)	NPSHr (м)	Масса (kg)
	(m³/h)	(L/s)							
NSC900-800-840	7700	2138.9	59	740	2000	1509.7	82	7.1	8400
	10100	2805.6	52			1608.1	89	8.1	
	11500	3194.4	45.5			1677.5	85	10.0	
NSC900-800-840A	7500	2083.3	47		1600	1171.4	82	7.2	
	9000	2500.0	43.5			1226.3	87	7.7	
	10300	2861.1	39			1287.8	85	8.9	
NSC900-800-840B	7600	2111.1	40		1400	1010.2	82	7.3	
	8800	2444.4	37			1043.8	85	7.7	
	10100	2805.6	33			1107.6	82	9.1	
NSC900-800-840L	6930	1925.0	59	740	2000	1358.7	82	7.1	8400
	9090	2525.0	52			1447.3	89	8.1	
	10350	2875.0	45.5			1509.7	85	10.0	
NSC900-800-840LA	6750	1875.0	47		1600	1054.3	82	7.2	
	8100	2250.0	43.5			1103.6	87	7.7	
	9270	2575.0	39			1159.0	85	8.9	
NSC900-800-840LB	6840	1900.0	40		1400	909.2	82	7.3	
	7920	2200.0	37			939.5	85	7.7	
	9090	2525.0	33			996.9	82	9.1	

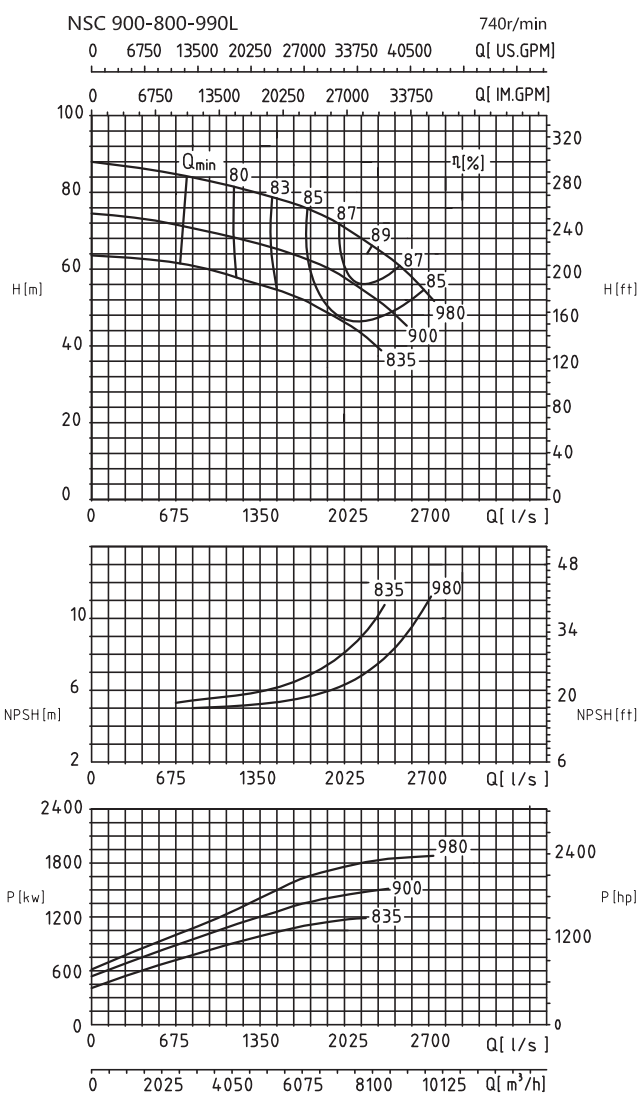
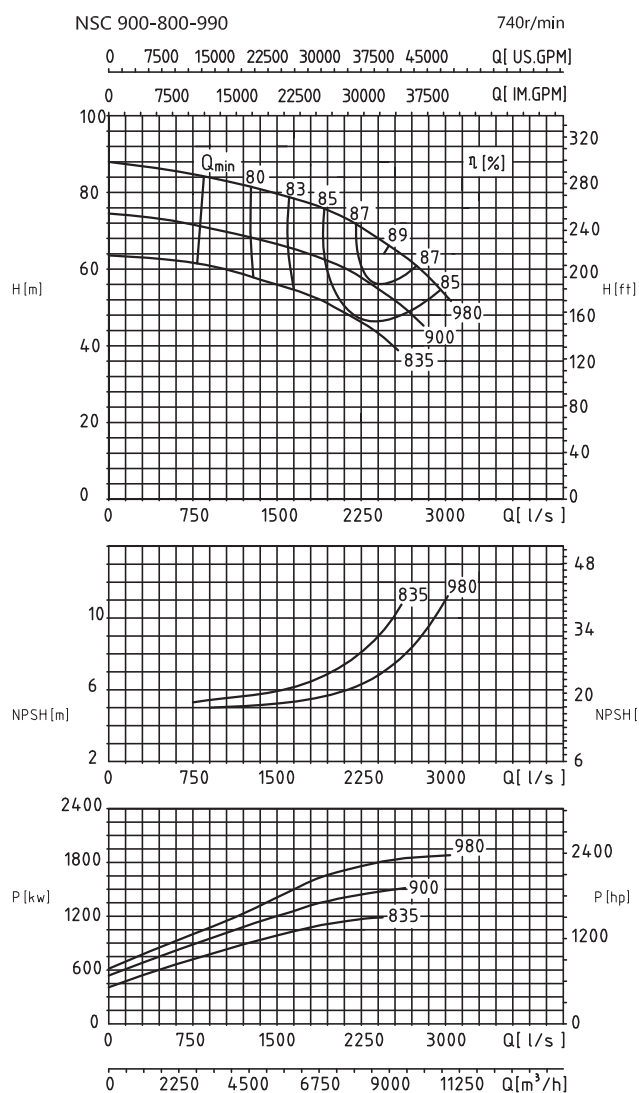

Модель	Производительность		Напор (м)	Скорость (r/min)	Мощность (kw)	Мощность на валу (kw)	КПД (%)	NPSHr (м)	Масса (kg)
	(m³/h)	(L/s)							
NSC900-800-990	7000	1944.4	76	740	2240	1705.5	85	5.8	9800
	8950	2486.1	66			1808.6	89	7.1	
	10250	2847.2	58			1883.7	86	9.5	
NSC900-800-990A	6450	1791.7	64		1800	1339.1	84	6.0	
	8100	2250.0	58			1488.6	86	7.1	
	9180	2550.0	52			1530.4	85	9.0	
NSC900-800-990B	5900	1638.9	55		1600	1105.3	80	6.1	
	7300	2027.8	50			1213.0	82	7.1	
	8600	2388.9	44			1273.0	81	8.8	
NSC900-800-990L	6300	1750.0	76	2000	1535.0	85	5.8	9800	
	8055	2237.5	66		1627.7	89	7.1		
	9225	2562.5	58		1695.4	86	9.5		
NSC900-800-990LA	5805	1612.5	64	1800	1205.2	84	6.0		
	7290	2025.0	58		1339.7	86	7.1		
	8262	2295.0	52		1377.3	85	9.0		
NSC900-800-990LB	5310	1475.0	55	1400	994.8	80	6.1		
	6570	1825.0	50		1091.7	82	7.1		
	7740	2150.0	44		1145.7	81	8.8		

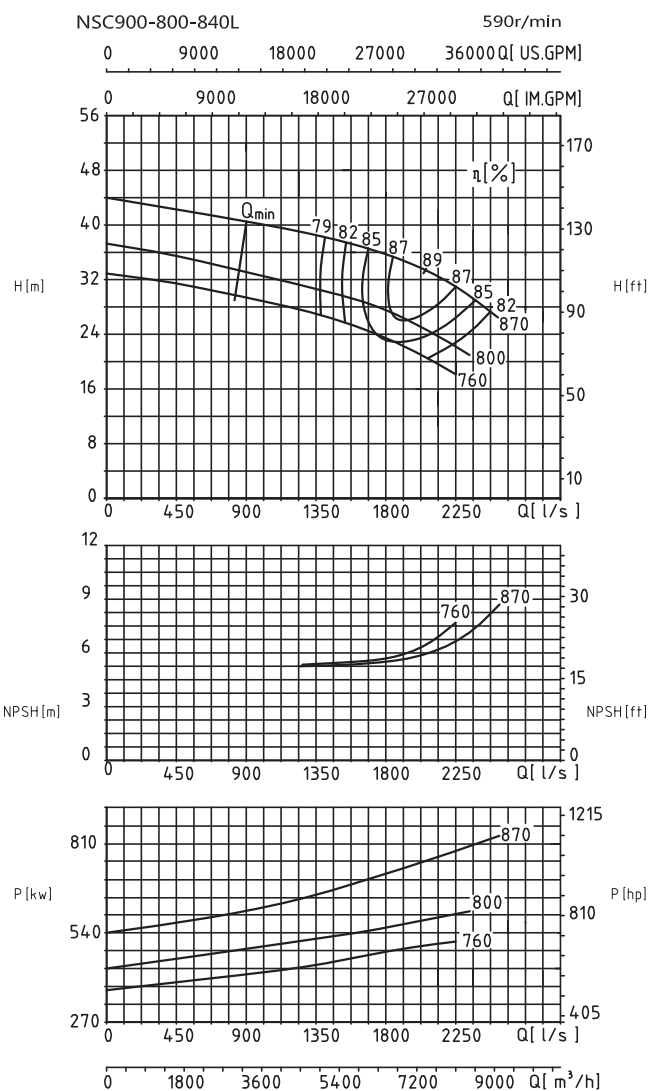
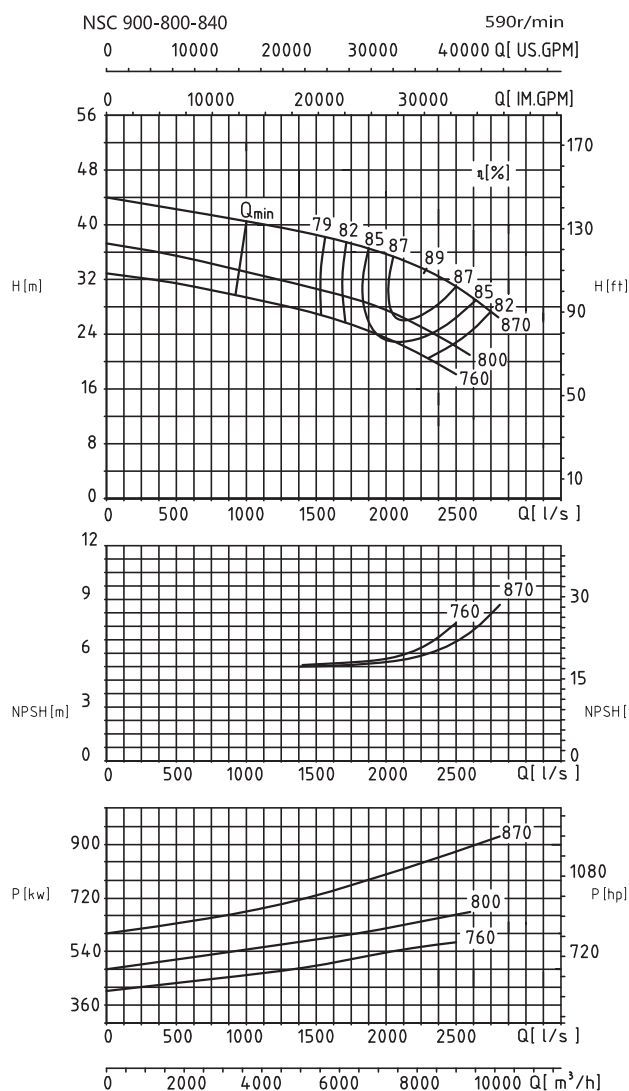

Модель	Производительность		Напор (m)	Скорость (r/min)	Мощность (kw)	Мощность на валу (kw)	КПД (%)	NPSHr (m)	Масса (kg)
	(m³/h)	(L/s)							
NSC900-800-840	7056	1960.0	36	590	1000	804.9	86	5.5	8400
	8221	2283.6	33.4			840.7	89	6.0	
	9000	2500.0	31			873.9	87	6.8	
NSC900-800-840A	6800	1888.9	28.4		710	622.8	84.5	5.5	
	7350	2041.7	27.3			628.5	87	5.8	
	8100	2250.0	25			637.9	86.5	6.2	
NSC900-800-840B	6660	1850.0	24.6		630	531.5	84	5.5	
	7093	1970.3	24			545.7	85	5.6	
	7650	2125.0	22.3			550.8	84.4	5.9	
NSC900-800-840L	6350	1764.0	36	1000	724.4	86	5.5	8400	
	7399	2055.3	33.4		756.6	89	6.0		
	8100	2250.0	31		786.5	87	6.8		
NSC900-800-840LA	6120	1700.0	28.4	710	560.5	84.5	5.5		
	6615	1837.5	27.3		565.6	87	5.8		
	7290	2025.0	25		574.1	86.5	6.2		
NSC900-800-840LB	5994	1665.0	24.6	630	478.3	84	5.5		
	6384	1773.3	24		491.2	85	5.6		
	6885	1912.5	22.3		495.7	84.4	5.9		

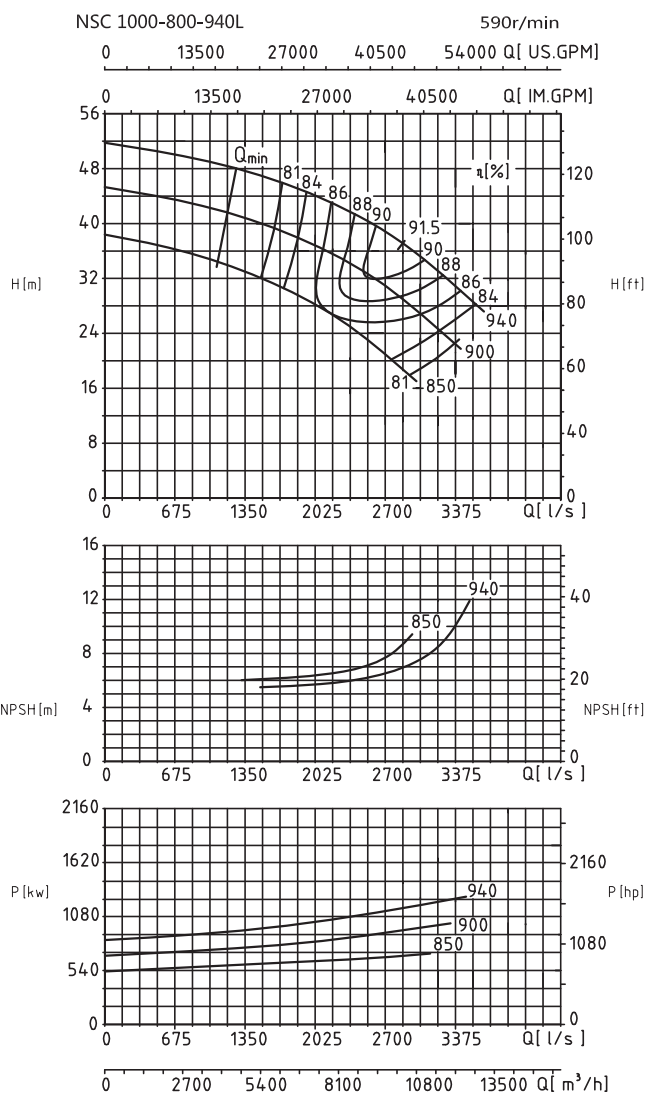
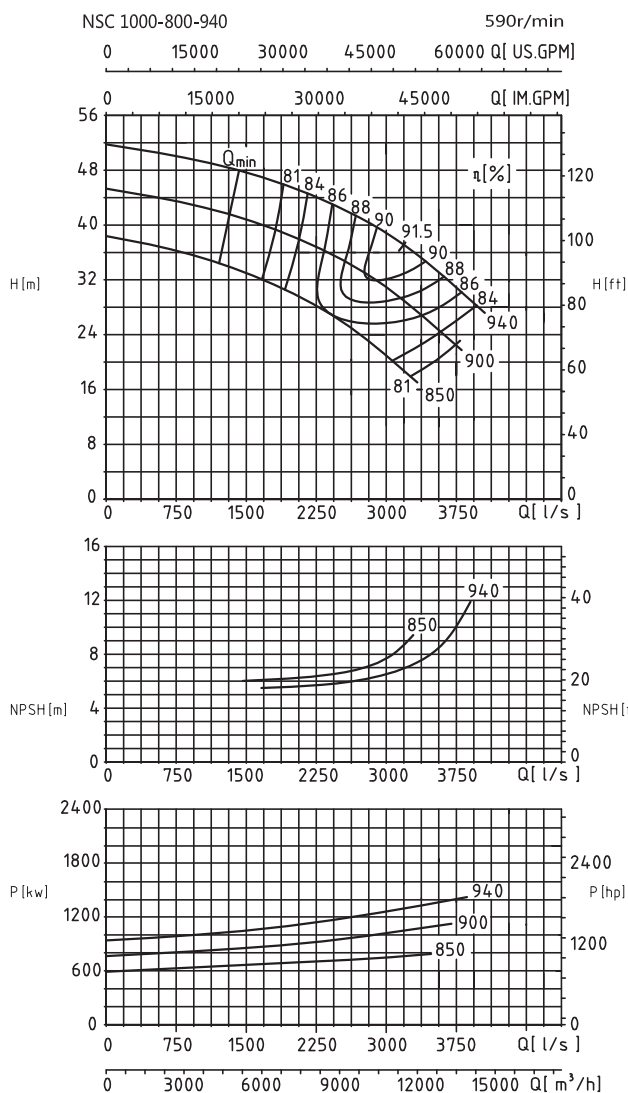

Модель	Производительность		Напор (м)	Скорость (r/min)	Мощность (kw)	Мощность на валу (kw)	КПД (%)	NPSHr (м)	Масса (kg)
	(m³/h)	(L/s)							
NSC1000-800-940	9450	2625.0	41.7	590	1600	1225.8	87.6	6.0	10400
	11475	3187.5	37.1			1267.9	91.5	7.0	
	12825	3562.5	33.1			1307.1	88.5	9.0	
NSC1000-800-940A	8100	2250.0	36.8		951.1	85.4	6.0		
	10420	2894.4	33		1029.7	91	6.8		
	12150	3375.0	27		1038.3	86.1	9.1		
NSC1000-800-940B	6750	1875.0	30.8		674.4	84	6.1		
	8775	2437.5	26.7		742.4	86	6.5		
	10125	2812.5	23		744.8	85.2	7.1		
NSC1000-800-940L	8505	2625.0	41.7	1225.8	87.6	6.0			
	10328	3187.5	37.1	1267.9	91.5	7.0			
	11543	3562.5	33.1	1307.1	88.5	9.0			
NSC1000-800-940LA	7290	2250.0	36.8	951.1	85.4	6.0			
	9378	2894.4	33	1029.7	91	6.8			
	10935	3375.0	27	1038.3	86.1	9.1			
NSC1000-800-940LB	6075	1875.0	30.8	674.4	84	6.1			
	7898	2437.5	26.7	742.4	86	6.5			
	9113	2812.5	23	744.8	85.2	7.1			

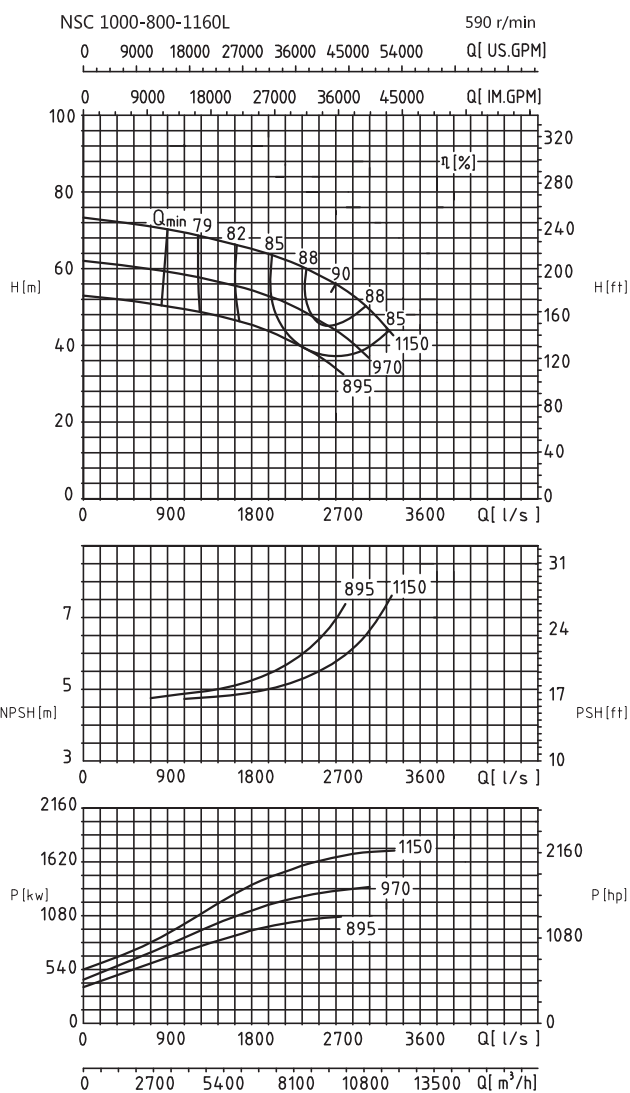
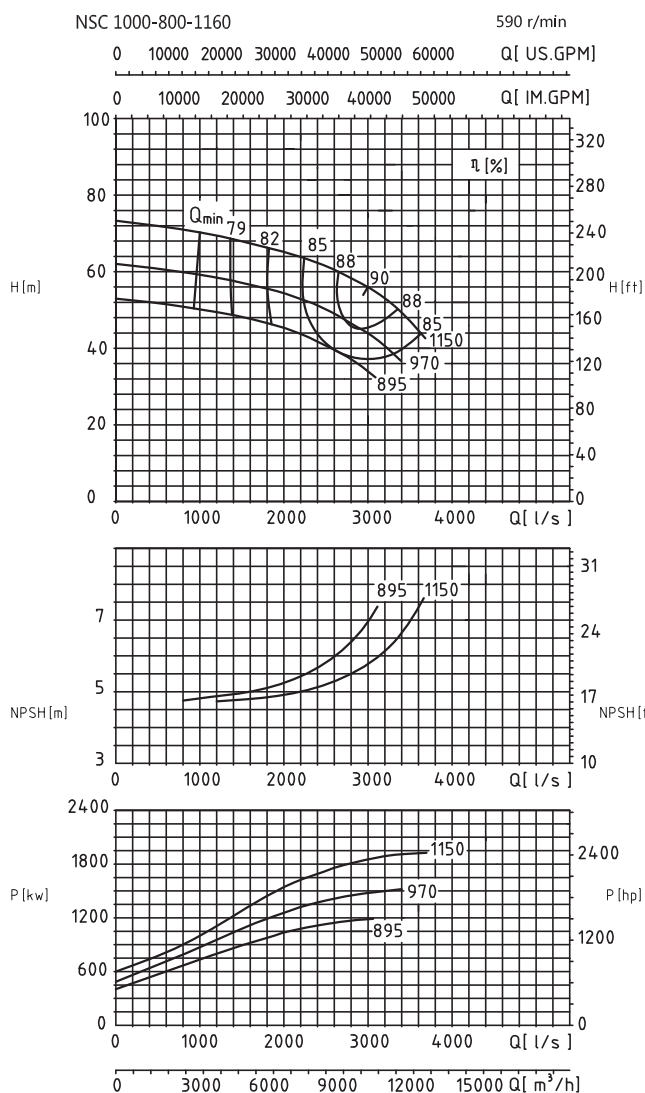

Модель	Производительность		Напор (м)	Скорость (r/min)	Мощность (kw)	Мощность на валу (kw)	КПД (%)	NPSHr (м)	Масса (kg)
	(m³/h)	(L/s)							
NSC1000-800-1160	7920	2200.0	64	590	2240	1625.0	85	5.0	13800
	10800	3000.0	56			1831.2	90	5.8	
	12300	3416.7	48			1849.2	87	6.7	
NSC1000-800-1160A	7200	2000.0	64.5		1800	1524.7	83	5.3	
	9360	2600.0	49			1453.2	86	6.2	
	11150	3097.2	42			1501.3	85	6.7	
NSC1000-800-1160B	6550	1819.4	46.5		1400	1012.2	82	5.2	
	8640	2400.0	41.5			1149.5	85	5.6	
	10080	2800.0	37			1209.9	84	6.5	
NSC1000-800-1160L	7128	1980.0	64	2000	1462.5	85	5.0		
	9720	2700.0	56		1648.1	90	5.8		
	11070	3075.0	48		1664.3	87	6.7		
NSC1000-800-1160LA	6480	1800.0	64.5	1600	1372.2	83	5.3		
	8424	2340.0	49		1307.9	86	6.2		
	10035	2787.5	42		1351.2	85	6.7		
NSC1000-800-1160LB	5895	1637.5	46.5	1250	910.9	82	5.2		
	7776	2160.0	41.5		1034.6	85	5.6		
	9072	2520.0	37		1088.9	84	6.5		

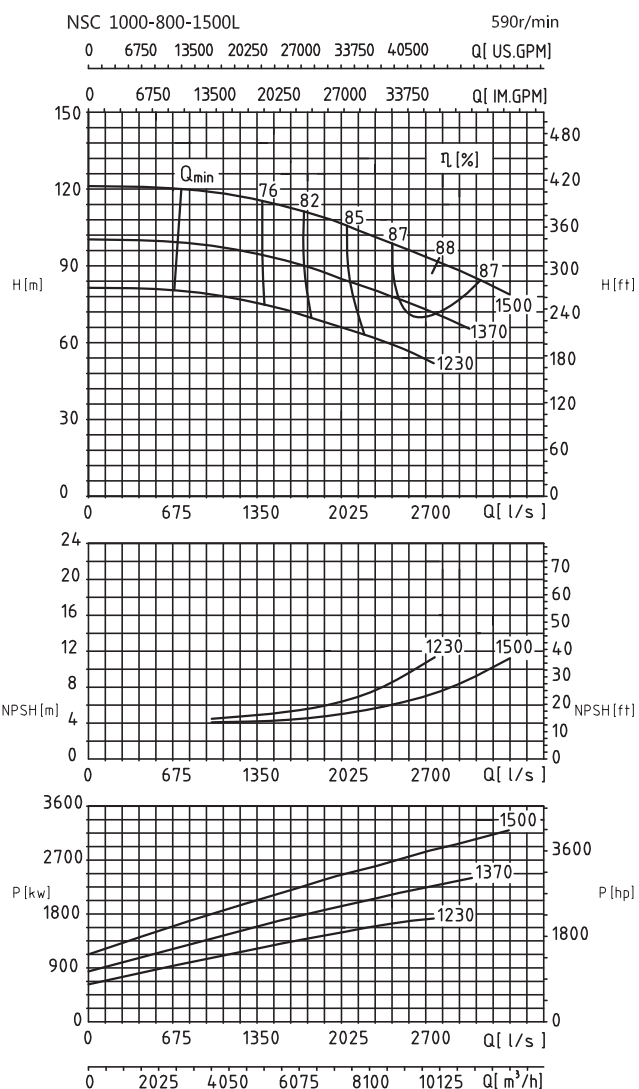
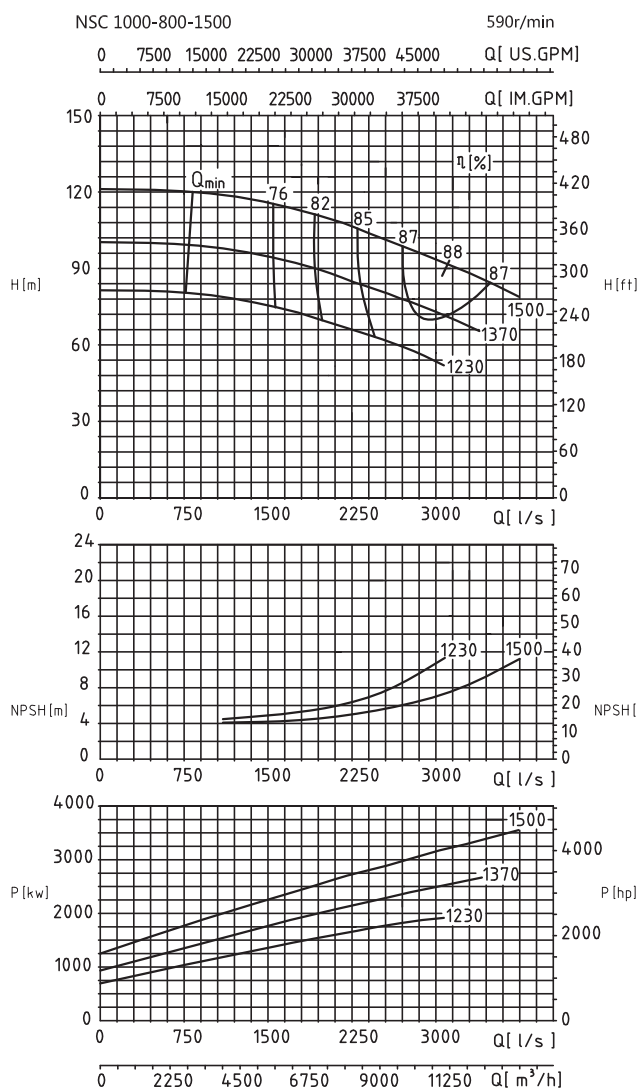

Модель	Производительность		Напор (м)	Скорость (r/min)	Мощность (kw)	Мощность на валу (kw)	КПД (%)	NPSHг (м)	Масса (kg)
	(m³/h)	(L/s)							
NSC1000-800-1500	8130	2258.3	106	590	4000	2762.8	85	5.0	16400
	11200	3111.1	92			3190.7	88	7.1	
	12400	3444.4	84			3262.5	87	9.2	
NSC1000-800-1500A	7560	2100.0	87		3150	2159.4	83	5.3	
	9720	2700.0	78			2402.3	86	7.1	
	11340	3150.0	70			2544.8	85	9.8	
NSC1000-800-1500B	7050	1958.3	70		2240	1640.0	82	5.9	
	8640	2400.0	64			1772.7	85	7.0	
	10250	2847.2	56			1862.1	84	9.8	
NSC1000-800-1500L	7317	2032.5	106	3550	2486.5	85	5.0		
	10080	2800.0	92		2871.7	88	7.1		
	11160	3100.0	84		2936.2	87	9.2		
NSC1000-800-1500LA	6804	1890.0	87	2800	1943.4	83	5.3		
	8748	2430.0	78		2162.1	86	7.1		
	10206	2835.0	70		2290.3	85	9.8		
NSC1000-800-1500LB	6345	1762.5	70	2000	1476.0	82	5.9		
	7776	2160.0	64		1595.5	85	7.0		
	9225	2562.5	56		1675.9	84	9.8		

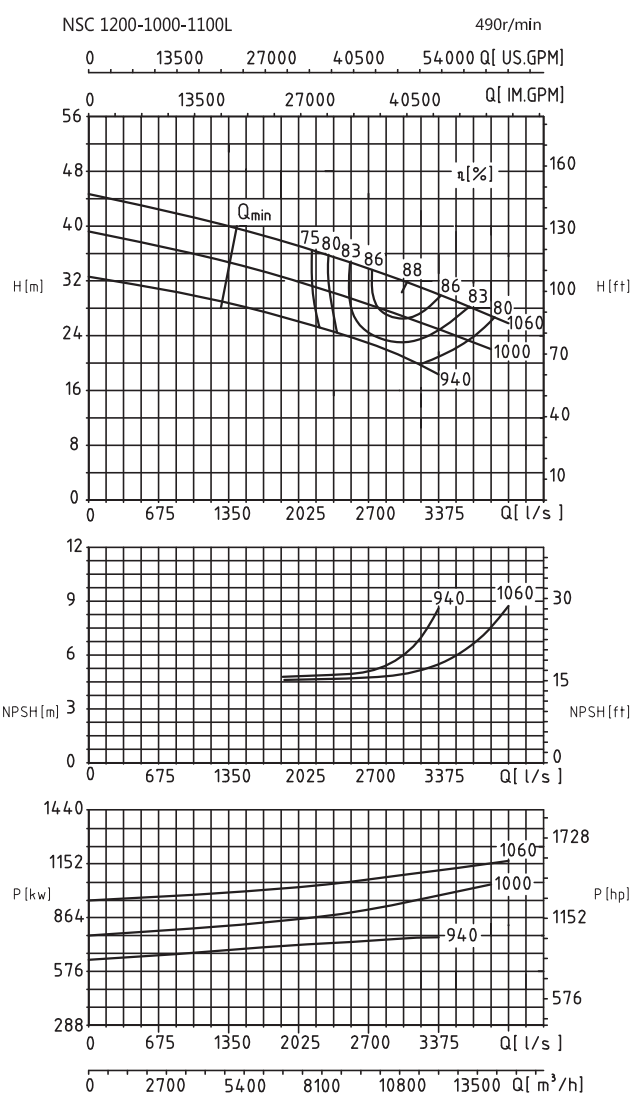
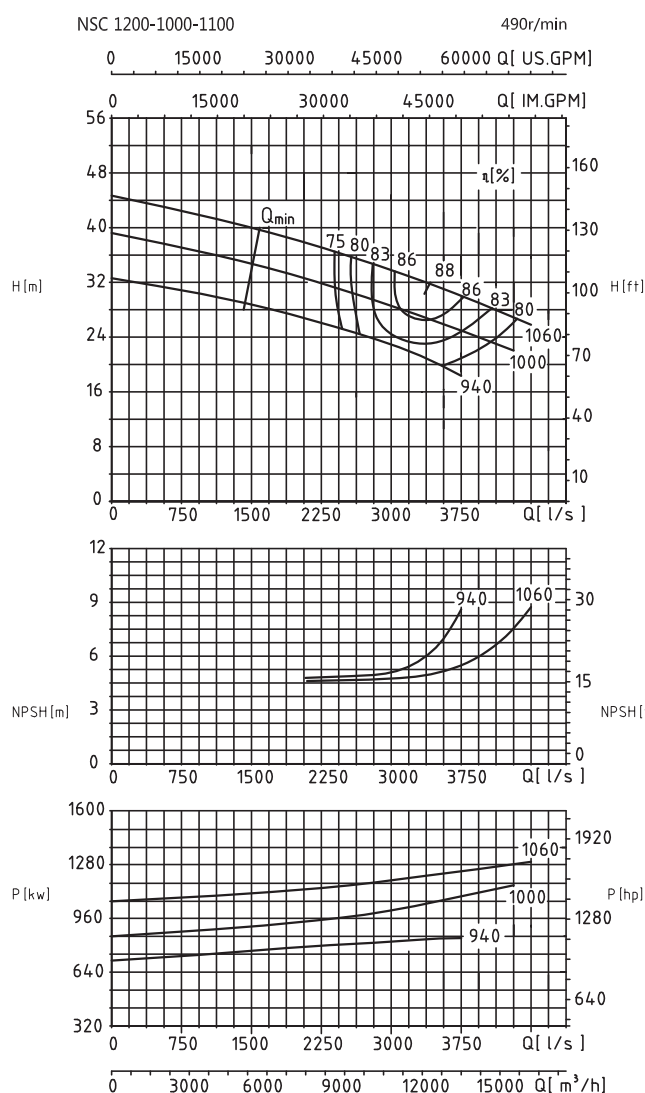

Модель	Производительность		Напор (m)	Скорость (r/min)	Мощность (kw)	Мощность на валу (kw)	КПД (%)	NPSHr (m)	Масса (kg)
	(m³/h)	(L/s)							
NSC1200-1000-1100	11461	3183.6	33.75	490	1600	1266.9	83.2	4.9	15100
	12285	3412.5	31.9			1227.5	87	5.1	
	13650	3791.7	30.11			1330.1	84.2	5.7	
NSC1200-1000-1100A	10125	2812.5	29.5		1250	978.3	83.2	5.0	
	11475	3187.5	27.7			1004.8	86.2	5.3	
	12825	3562.5	25.9			1062.4	85.2	6.6	
NSC1200-1000-1100B	9585	2662.5	24.5		1000	799.9	80	5.2	
	10800	3000.0	22.9			816.9	82.5	5.3	
	12150	3375.0	20.9			843.9	82	6.2	
NSC1200-1000-1100L	10315	2865.3	33.75	1600	1140.2	83.2	4.9	15100	
	11057	3071.3	31.9		1104.7	87	5.1		
	12285	3412.5	30.11		1197.1	84.2	5.7		
NSC1200-1000-1100LA	9113	2531.3	29.5	1250	880.4	83.2	5.0		
	10328	2868.8	27.7		904.3	86.2	5.3		
	11543	3206.3	25.9		956.2	85.2	6.6		
NSC1200-1000-1100LB	8627	2396.3	24.5	1000	719.9	80	5.2		
	9720	2700.0	22.9		735.2	82.5	5.3		
	10935	3037.5	20.9		759.5	82	6.2		

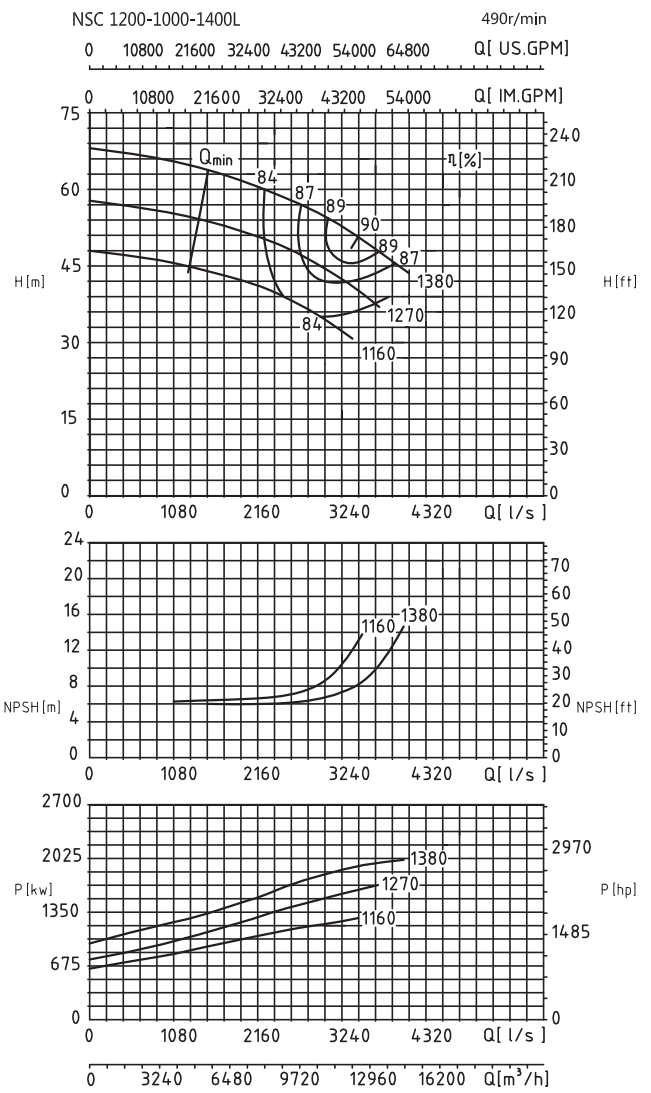
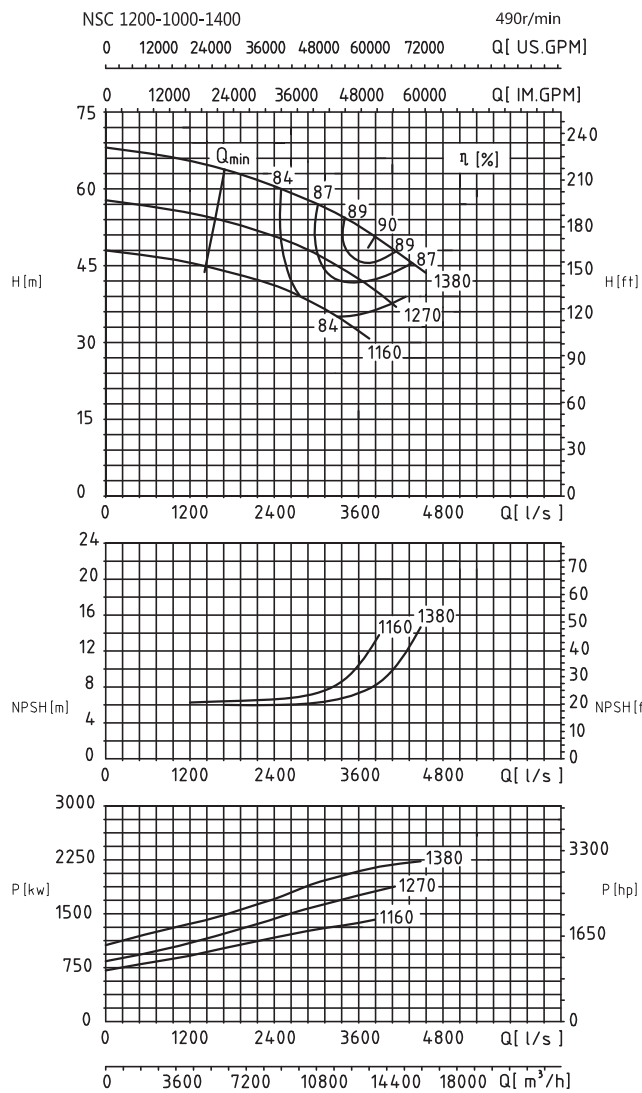

Модель	Производительность		Напор (m)	Скорость (r/min)	Мощность (kw)	Мощность на валу (kw)	КПД (%)	NPSHr (m)	Масса (kg)
	(m³/h)	(L/s)							
NSC1200-1000-1400	10970	3047.2	57	490	2500	1958.5	87	6.1	17200
	14000	3888.9	51			2161.8	90	8.1	
	15640	4344.4	45			2204.4	87	12.1	
NSC1200-1000-1400A	9500	2638.9	49.5		2000	1507.6	85	6.2	
	11830	3286.1	45			1648.5	88	7.2	
	13820	3838.9	40.5			1794.4	85	10.3	
NSC1200-1000-1400B	8640	2400.0	41		1600	1177.2	82	6.5	
	10370	2880.6	38			1263.3	85	7.1	
	12100	3361.1	34.5			1370.5	83	8.7	
NSC1200-1000-1400L	9873	2742.5	57	2240	1762.7	87	6.1		
	12600	3500.0	51		1945.7	90	8.1		
	14076	3910.0	45		1984.0	87	12.1		
NSC1200-1000-1400LA	8550	2375.0	49.5	2000	1356.8	85	6.2		
	10647	2957.5	45		1483.6	88	7.2		
	12438	3455.0	40.5		1614.9	85	10.3		
NSC1200-1000-1400LB	7776	2160.0	41	1600	1059.5	82	6.5		
	9333	2592.5	38		1137.0	85	7.1		
	10890	3025.0	34.5		1233.5	83	8.7		

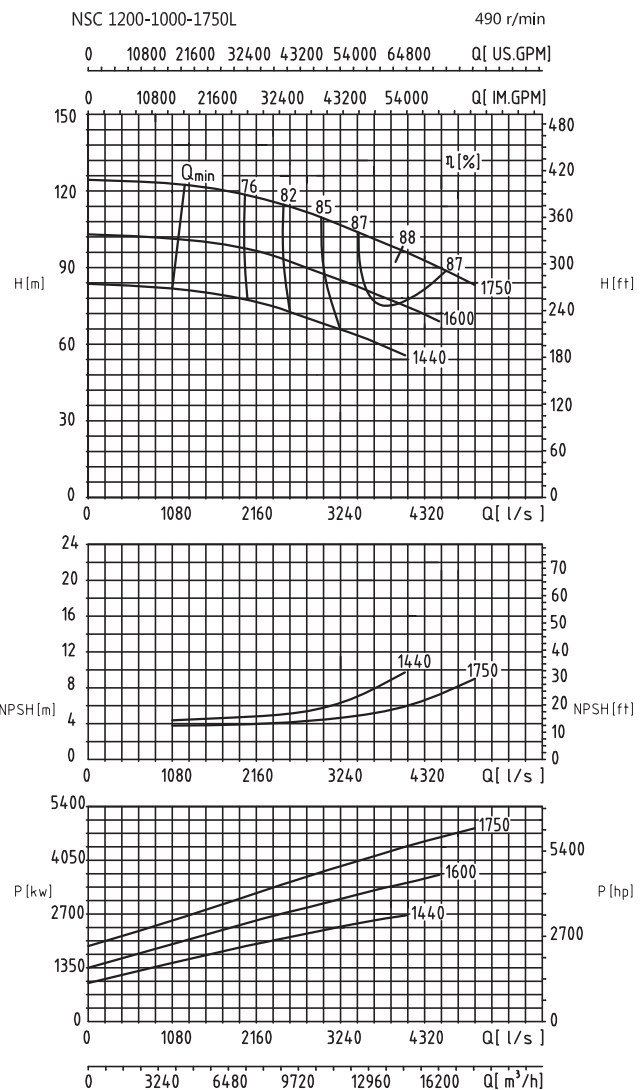
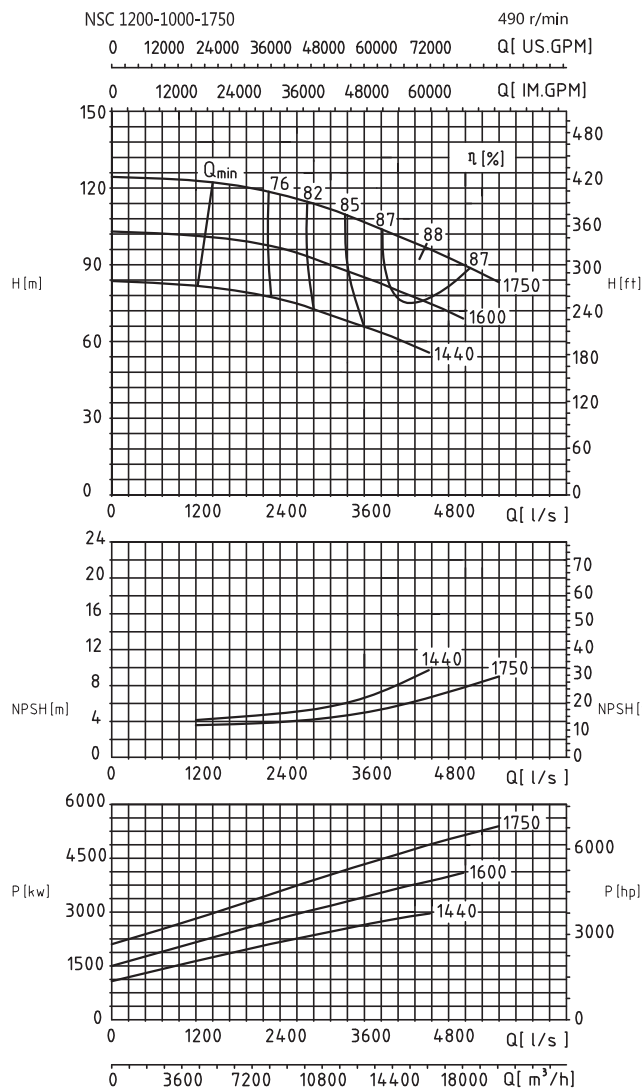

Модель	Производительность		Напор (m)	Скорость (r/min)	Мощность (kw)	Мощность на валу (kw)	КПД (%)	NPSH _г (m)	Масса (kg)
	(m ³ /h)	(L/s)							
NSC1200-1000-1750	12100	3361.1	109	490	6300	4228.2	85	4.8	19500
	16000	4444.4	97			4805.9	88	6.5	
	18150	5041.7	89.5			5088.0	87	8.0	
NSC1200-1000-1750A	11230	3119.4	90		4500	3318.3	83	5.1	
	13820	3838.9	84			3678.4	86	6.8	
	16400	4555.6	75			3943.2	85	8.5	
NSC1200-1000-1750B	10370	2880.6	72		3550	2481.2	82	5.5	
	12960	3600.0	66			2742.2	85	6.5	
	14760	4100.0	60			2907.5	83	8.4	
NSC1200-1000-1750L	10890	3025.0	109	5600	3805.4	85	4.8		
	14400	4000.0	97		4325.3	88	6.5		
	16335	4537.5	89.5		4579.2	87	8.0		
NSC1200-1000-1750LA	10107	2807.5	90	4500	2986.4	83	5.1		
	12438	3455.0	84		3310.5	86	6.8		
	14760	4100.0	75		3548.9	85	8.5		
NSC1200-1000-1750LB	9333	2592.5	72	3150	2233.1	82	5.5		
	11664	3240.0	66		2468.0	85	6.5		
	13284	3690.0	60		2616.8	83	8.4		

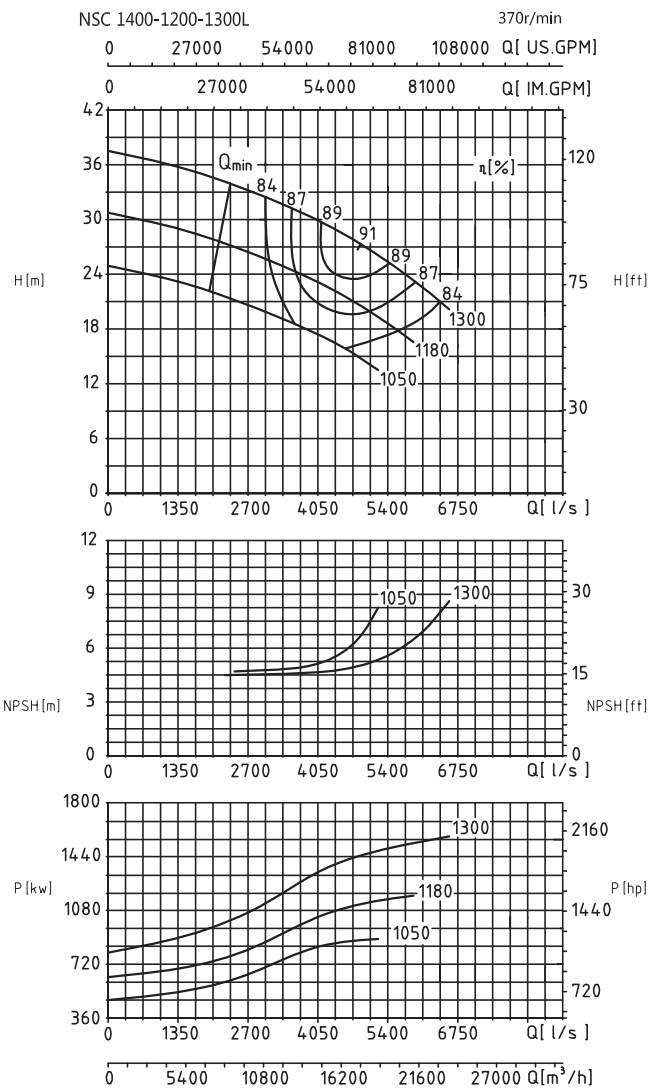
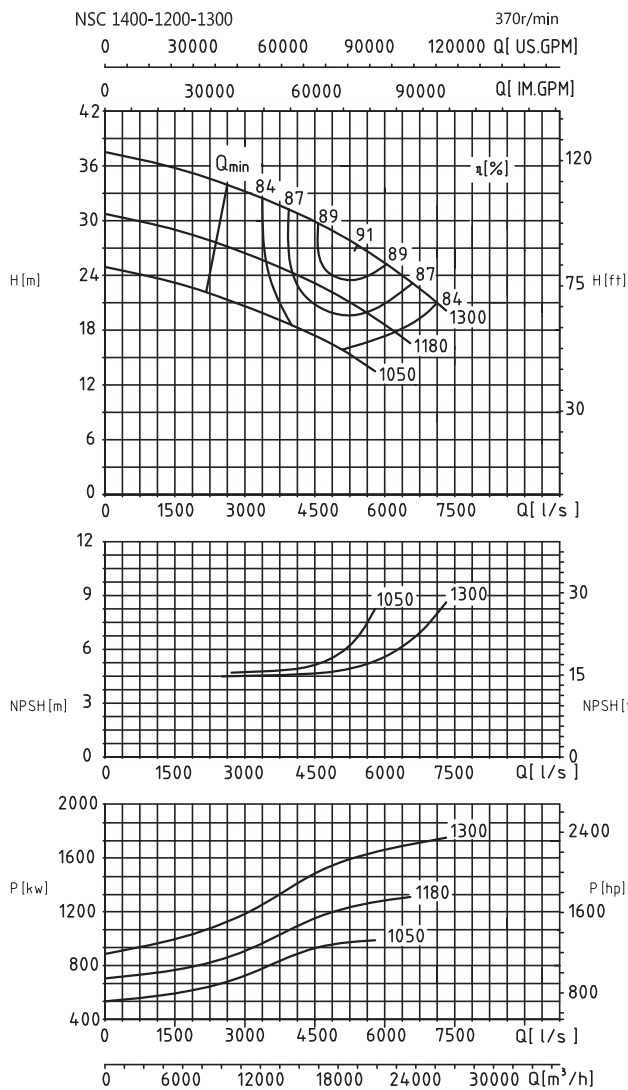

Модель	Производительность		Напор (m)	Скорость (r/min)	Мощность (kw)	Мощность на валу (kw)	КПД (%)	NPSHr (m)	Масса (kg)
	(m³/h)	(L/s)							
NSC1400-1200-1300	14175	3937.5	31.5	370	2000	1398.6	87	4.5	18700
	19800	5500.0	27			1600.9	91	5.2	
	23760	6600.0	23			1711.7	87	6.7	
NSC1400-1200-1300A	13500	3750.0	25		1600	1082.0	85	4.6	
	17550	4875.0	22			1195.6	88	5.3	
	21600	6000.0	18.5			1281.1	85	6.9	
NSC1400-1200-1300B	12150	3375.0	20		1250	807.5	82	4.6	
	16200	4500.0	17.5			908.9	85	5.2	
	19170	5325.0	15			944.1	83	6.7	
NSC1400-1200-1300L	12758	3543.8	31.5	1800	1258.7	87	4.5		
	17820	4950.0	27		1440.8	91	5.2		
	21384	5940.0	23		1540.5	87	6.7		
NSC1400-1200-1300LA	12150	3375.0	25	1400	973.8	85	4.6		
	15795	4387.5	22		1076.0	88	5.3		
	19440	5400.0	18.5		1153.0	85	6.9		
NSC1400-1200-1300LB	10935	3037.5	20	1120	726.8	82	4.6		
	14580	4050.0	17.5		818.0	85	5.2		
	17253	4792.5	15		849.7	83	6.7		

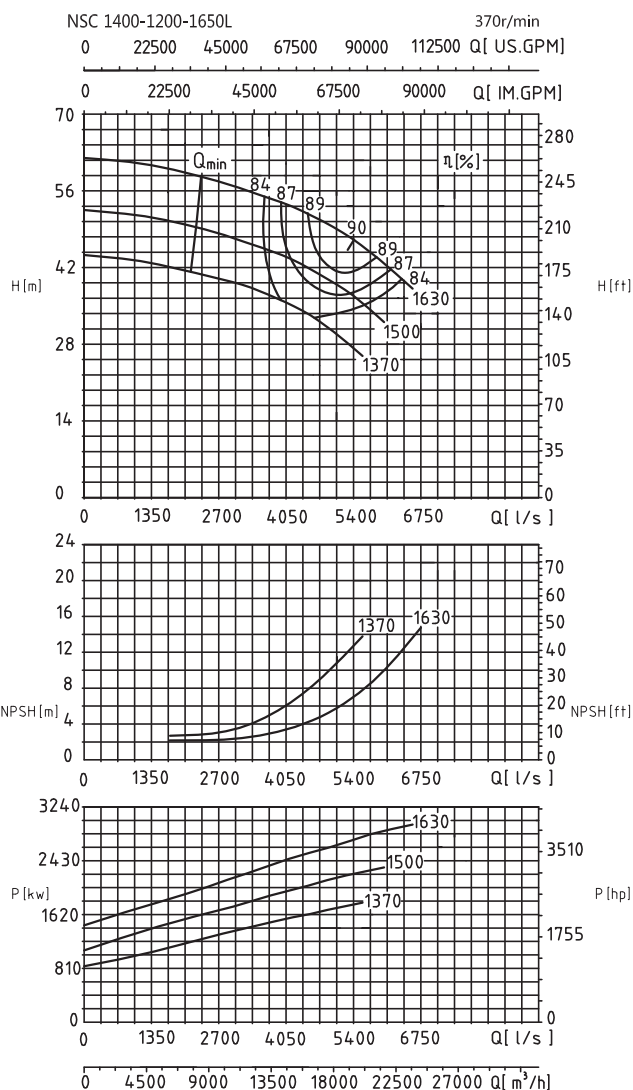
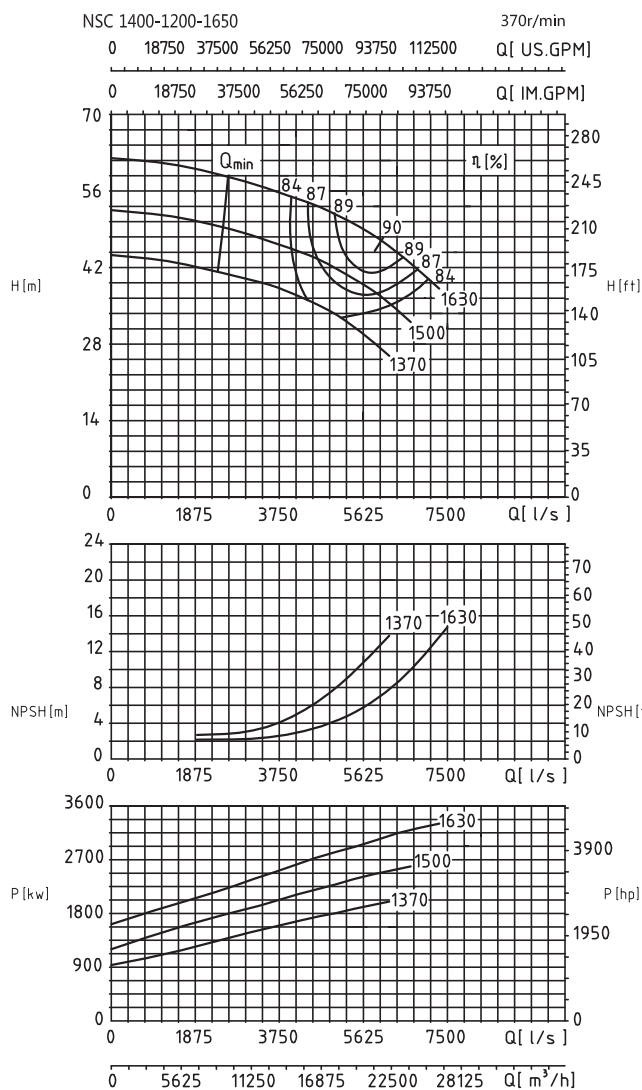

Модель	Производительность		Напор (м)	Скорость (r/min)	Мощность (kw)	Мощность на валу (kw)	КПД (%)	NPSHr (m)	Масса (kg)
	(m³/h)	(L/s)							
NSC1400-1200-1650	15800	4388.9	53.5	370	4000	2647.6	87	3.6	21700
	21600	6000.0	47			3040.0	91	7.0	
	24400	6777.8	42			3209.9	87	10.3	
NSC1400-1200-1650A	16200	4500.0	44		3150	2258.6	86	4.2	
	20250	5625.0	39.2			2458.1	88	8.1	
	22500	6250.0	35.3			2576.6	84	10.6	
NSC1400-1200-1650B	14850	4125.0	36.5		2500	1779.5	83	5.0	
	17550	4875.0	33.7			1896.1	85	7.6	
	20250	5625.0	30			2018.8	82	11.0	
NSC1400-1200-1650L	14220	3950.0	53.5	370	3550	2382.9	87	3.6	21700
	19440	5400.0	47			2736.0	91	7.0	
	21960	6100.0	42			2888.9	87	10.3	
NSC1400-1200-1650LA	14580	4050.0	44		2800	2032.7	86	4.2	
	18225	5062.5	39.2			2212.3	88	8.1	
	20250	5625.0	35.3			2318.9	84	10.6	
NSC1400-1200-1650LB	13365	3712.5	36.5		2240	1601.6	83	5.0	
	15795	4387.5	33.7			1706.5	85	7.6	
	18225	5062.5	30			1816.9	82	11.0	

Размеры

Размеры насоса с открытым валом

Направление вращения: По часовой стрелке

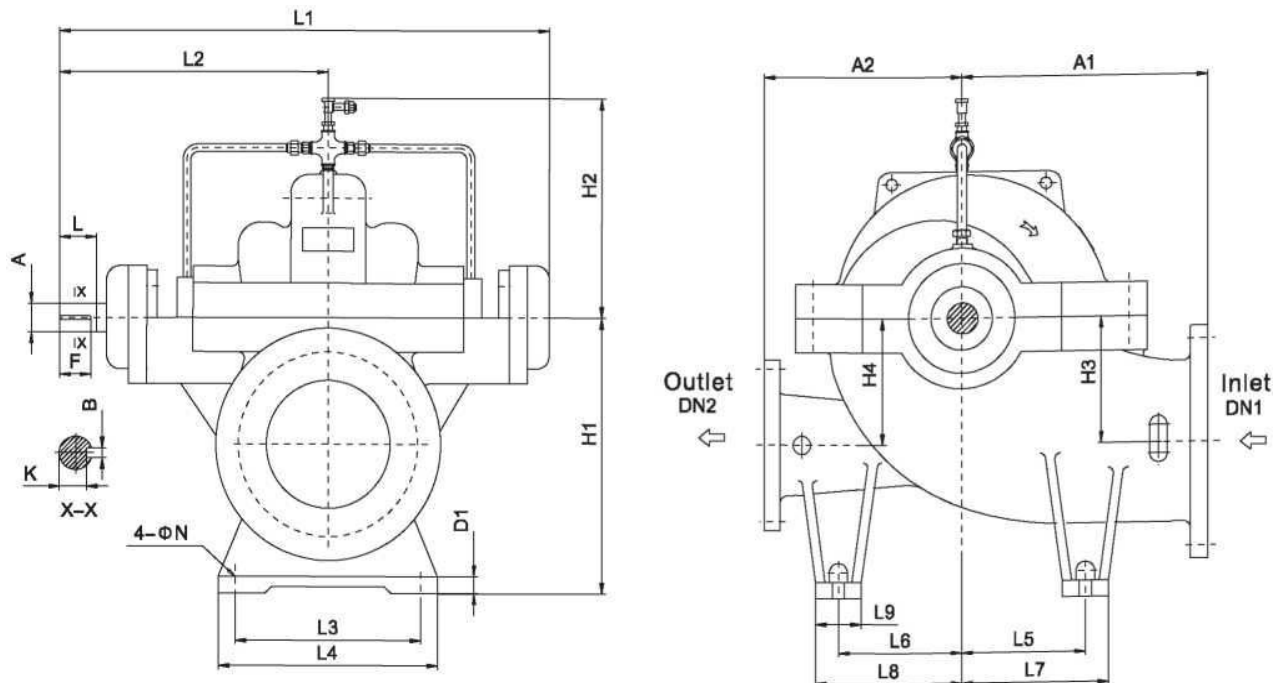

Размеры—Насос с голым валом (1/2)

Единица: мм, если не указано другое

Модель	A1	A2	H1	H2	H3	H4	L1	L2	L3	L4	L5	L6	L7	L8	L9	D1	N	A	L	B	K	F
NSC125-80-210	300	300	315	270	150	150	788.9	440.5	270	320	170	170	205	205	70	30	18	35	81.5	10	30	75
NSC125-80-270	300	300	315	269	150	150	788.9	440.5	270	320	170	170	205	205	70	30	18	35	81.5	10	30	75
NSC125-80-350	330	330	315	333	140	140	788.9	440.5	270	320	170	170	210	210	80	30	18	35	81.5	10	30	75
NSC150-100-250	330	330	355	328	170	170	788.9	440.5	270	320	200	200	240	240	80	30	18	35	81.5	10	30	75
NSC150-100-320	330	330	355	342	170	170	788.9	440.5	270	320	200	200	240	240	80	30	18	35	81.5	10	30	75
NSC150-100-400	370	370	355	260	170	170	788.9	440.5	270	320	200	200	245	245	90	30	18	35	81.5	10	30	75
NSC200-125-240	370	370	400	300	200	200	871	500	380	430	200	200	240	240	80	30	25	45	111.5	14	39.5	105
NSC200-125-300	370	370	400	325	200	200	871	500	380	430	225	225	265	265	80	30	25	45	111.5	14	39.5	105
NSC200-125-380	395	370	400	350	200	200	871	500	340	390	225	225	265	265	80	30	25	45	111.5	14	39.5	105
NSC200-125-480	450	450	400	389	200	200	871	500	340	390	280	280	320	320	80	30	25	45	111.5	14	39.5	105
NSC200-150-290	400	400	400	340	200	200	871	500	380	430	225	225	265	265	80	30	25	45	111.5	14	39.5	105
NSC200-150-360	400	400	400	380	200	200	871	500	380	430	225	225	265	265	80	30	25	45	111.5	14	39.5	105
NSC200-150-460	450	450	400	390	200	200	1006.1	569.3	430	480	280	280	320	320	80	30	25	55	112.7	16	49	100
NSC200-150-570	600	500	500	460	300	300	1006.1	569.3	430	480	350	350	400	400	100	30	25	55	112.7	16	49	100
NSC250-200-250	500	400	450	360	240	240	949	537	430	480	280	280	320	320	80	25	25	42	110	12	37	105
NSC250-200-340	450	450	500	368	240	240	1006.1	569.3	430	480	280	280	320	320	80	30	25	55	112.7	16	49	100
NSC250-200-430	500	500	500	400	240	240	1006.1	569.3	430	480	280	280	325	325	90	30	25	55	112.7	16	49	100
NSC250-200-530	600	500	560	470	300	300	1110.8	637.3	430	480	350	350	400	400	100	30	25	65	143.2	18	58	135
NSC250-200-660	650	550	600	525	350	350	1110.8	637.3	440	520	350	350	400	400	100	30	25	65	143.2	18	58	135
NSC300-250-270	500	450	600	404	300	300	1006.1	569.3	430	480	300	270	340	310	80	30	25	55	112.7	16	49	100
NSC300-250-280	500	450	600	404	300	300	1006.1	569.3	430	480	300	270	340	310	80	30	25	55	112.7	16	49	100
NSC300-250-390	500	500	600	417	300	300	1110.8	637.3	430	480	350	350	400	400	100	42	25	65	143.2	18	58	135
NSC300-250-490	550	550	600	583	300	300	1316.5	737.5	520	600	350	350	400	400	100	35	25	75	143.5	20	67.5	135

Размеры—Насос с голым валом (1/2)

Единица: мм, если не указано другое

Модель	A1	A2	H1	H2	H3	H4	L1	L2	L3	L4	L5	L6	L7	L8	L9	D1	N	A	L	B	K	F
NSC300-250-610	650	550	630	640	350	350	1316.5	737.5	520	600	350	350	400	400	100	42	25	75	143.5	20	67.5	135
NSC300-250-780	700	600	750	600	400	400	1533	870	600	700	350	350	425	425	150	42	25	85	172.5	22	76	165
NSC350-300-310	600	520	630	465	300	300	1110.8	637.3	480	560	350	300	415	365	130	35	25	65	143.2	18	58	135
NSC350-300-330	600	520	630	465	300	300	1110.8	637.3	480	560	350	300	415	365	130	35	25	65	143.2	18	58	135
NSC350-300-400	630	560	630	450	320	320	1243	696	480	560	350	350	415	415	130	35	25	65	143.2	18	58	135
NSC400-300-450	650	550	700	590	350	350	1316.5	737.5	520	600	350	350	400	400	100	40	25	75	143.5	20	67.5	135
NSC400-300-570	700	650	710	530	350	350	1527	870	520	600	475	475	525	525	100	40	25	85	172.5	22	76	165
NSC400-300-700	750	650	750	530	400	400	1527	870	600	700	425	425	485	485	120	40	25	85	172.5	22	76	165
NSC400-350-360	670	570	670	513	350	350	1316.5	737.5	630	710	330	330	380	380	100	35	25	75	143.5	20	67.5	135
NSC400-350-380	670	570	670	513	350	350	1316.5	737.5	630	710	330	330	380	380	100	35	25	75	143.5	20	67.5	135
NSC400-350-520	700	650	750	535	400	400	1527	870	520	600	475	475	525	525	100	35	25	85	172.5	22	76	165
NSC450-450-350	700	550	700	520	370	370	1308.5	737.5	700	800	330	330	380	380	100	35	25	75	143.5	20	67.5	135
NSC500-300-920	900	900	850	615	400	400	1909	1088	780	940	500	500	620	620	240	40	42	110	210	28	100	180
NSC500-300-780	800	750	800	535	400	400	1900	1055	580	740	450	450	570	570	240	45	35	110	210	28	100	180
NSC500-400-400	765	600	785	537	420	400	1438.5	821.5	560	640	400	400	460	460	120	35	30	75	143.5	20	67.5	135
NSC500-400-420	765	600	785	537	420	400	1438.5	821.5	560	640	400	400	460	460	120	35	30	75	143.5	20	67.5	135
NSC500-400-430	765	600	785	670	420	400	1582	897	560	640	400	400	460	460	120	40	35	80	170	22	71	160
NSC500-400-500	800	700	820	715	420	420	1623	918	780	940	400	400	520	520	240	40	35	80	170	22	71	160
NSC500-400-540	700	700	820	600	420	420	1773	1009	780	940	400	400	520	520	240	40	35	95	170	25	86	160
NSC500-400-590	900	750	850	700	470	470	1527	870	780	940	400	400	520	520	240	40	35	80	170	22	71	160
NSC500-400-660	850	750	850	641	450	450	1773	1009	780	940	500	400	620	520	240	40	35	95	170	25	86	160
NSC500-400-675	850	750	850	641	450	450	1527	870	780	940	450	450	580	580	240	40	35	80	170	22	71	160
NSC500-400-710	850	750	850	700	450	450	1717	988	780	940	450	450	570	570	240	35	40	100	210	28	90	200
NSC600-400-740	990	800	1000	697	530	530	1773	1009	780	940	560	460	680	580	240	40	35	95	170	25	86	160
NSC600-400-850	1030	880	1000	600	500	500	2009	1138	880	1060	600	600	730	730	260	50	42	110	210	28	100	180
NSC600-450-640	1000	800	970	690	510	510	1773	1009	780	940	525	525	650	650	250	50	42	95	170	25	86	180
NSC600-500-470	1020	740	970	737	550	525	1790	984	780	940	360	360	480	480	240	40	35	95	170	25	86	160
NSC600-500-520	1020	740	970	737	550	525	1790	984	780	940	360	360	480	480	240	40	35	95	170	25	86	160
NSC600-500-550	1020	740	970	737	550	525	1790	984	780	940	360	360	480	480	240	40	35	95	170	25	86	160
NSC700-500-670	1050	950	1035	725	550	550	1773	1009	780	940	625	525	750	650	250	50	42	95	170	25	86	180
NSC700-500-940	1050	950	1150	695	650	650	2308	1225	980	1100	700	600	810	710	220	50	42	130	250	32	119	245
NSC700-600-600	1050	850	1100	800	610	610	1935	1090	780	940	725	575	850	700	250	50	42	95	170	25	86	160
NSC700-600-680	1150	850	1100	800	610	610	1935	1090	780	940	725	575	850	700	250	50	42	95	170	25	86	160
NSC700-600-740	1160	1100	1070	725	570	570	1909	1088	880	1060	630	630	760	760	260	50	42	110	210	28	100	180
NSC700-700-500	1000	800	1000	640	530	530	1774	976	940	1100	625	425	750	550	250	50	42	90	170	25	81	160
NSC800-700-750	1315	1250	1250	870	710	680	2310	1278	1000	1250	725	725	875	875	300	60	42	120	210	32	109	200
NSC800-700-910	1150	1150	1250	890	700	700	2318	1278	1000	1200	725	725	875	875	300	50	42	130	250	32	119	245
NSC900-800-840	1450	1200	1350	1000	750	750	2533	1425	1250	1400	850	850	1000	1000	300	60	50	130	250	32	119	245
NSC1000-800-940	1450	1200	1500	1060	810	810	2700	1460	1250	1400	850	850	1000	1000	300	60	50	130	250	32	119	245

Примечание: Если требуемых размеров насоса в таблице нет, то свяжитесь с CNP

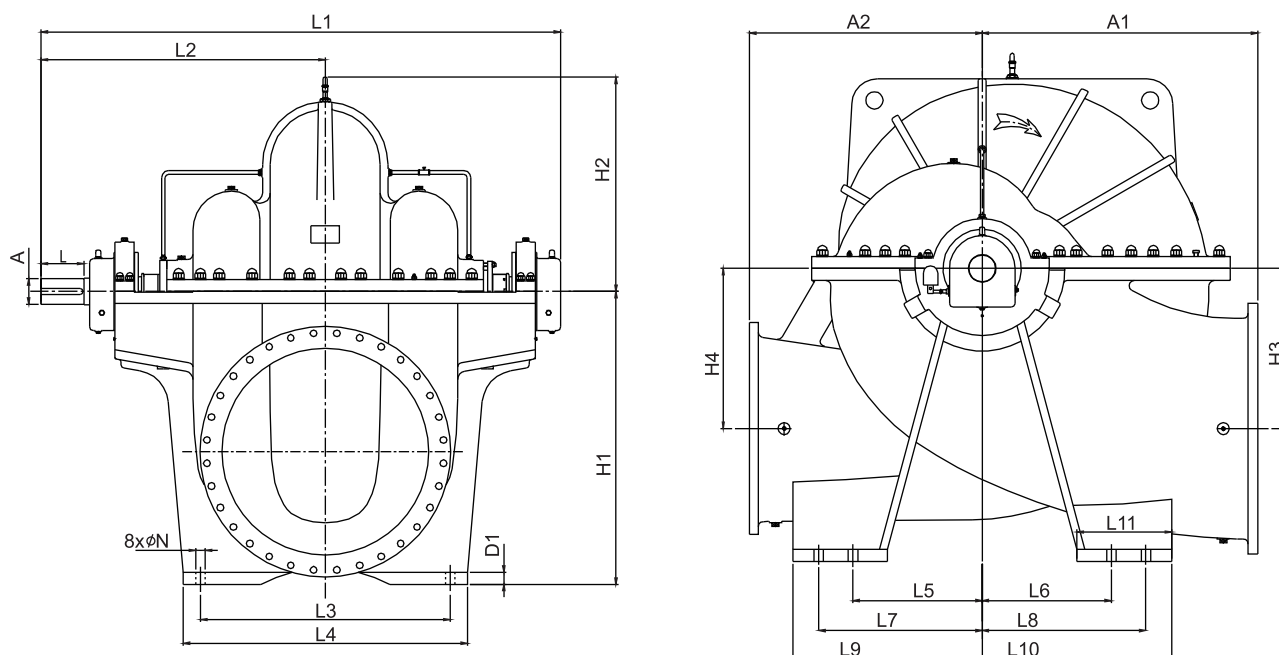

Модель	A1	A2	H1	H2	H3	H4	L1	L2	L3	L4	L5	L6	L7	L8	L9	L10	L11	D1	N	A	L
NSC600-400-1050	1050	900	1050	650	550	550	2550	1360	980	1100	420	420	600	600	720	720	420	60	45	150	250
NSC700-500-1150	1250	1050	1300	780	720	720	2700	1520	1250	1400	520	520	700	700	820	820	420	65	45	180	300
NSC800-600-1150	1350	1250	1300	800	680	680	2850	1580	1250	1400	650	650	850	850	1000	1000	500	55	45	180	300
NSC800-600-1430	1500	1300	1400	980	780	780	3100	1750	1450	1650	700	700	900	900	1050	1050	500	65	45	220	350
NSC900-700-1250	1450	1300	1400	860	720	720	2950	1650	1250	1400	700	700	900	900	1050	1050	500	60	45	180	300
NSC900-700-1550	1600	1350	1650	1040	900	900	3250	1820	1450	1650	750	750	950	950	1100	1100	500	70	55	220	350
NSC1000-800-1160	1800	1500	1550	1000	900	900	3280	1790	1700	1900	850	850	1050	1050	1250	1250	550	60	45	180	300
NSC1000-800-1500	1700	1500	1650	1060	860	860	3400	1860	1700	1900	850	850	1050	1050	1250	1250	550	70	55	220	350
NSC1200-1000-1100	1600	1350	1700	1250	930	930	3020	1650	1450	1650	750	750	900	900	1100	1100	550	70	55	150	250
NSC1200-1000-1400	1850	1600	1850	1300	1050	1050	3480	1920	1600	1900	900	900	1100	1100	1250	1250	500	70	55	190	350
NSC1200-1000-1750	2000	1800	1900	1500	1020	1020	3680	2050	1900	2100	1200	1200	1400	1400	1600	1600	550	75	55	260	410
NSC1400-1200-1300	2100	1800	2100	1600	1150	1150	3680	2050	1900	2100	1100	1100	1300	1300	1450	1450	550	70	55	220	350
NSC1400-1200-1650	2300	2000	2250	1700	1250	1250	4000	2220	2100	2300	1350	1350	1550	1550	1700	1700	550	80	55	260	410

Примечание: Если требуемых размеров насоса в таблице нет, то свяжитесь с CNP

Стандартные размеры фланца

Единицы: мм, если не указано другое

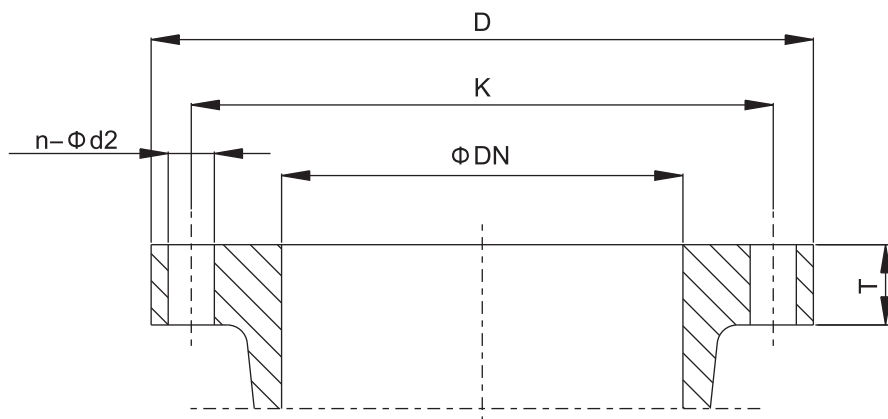

Примечание: Возможно изготовление фланцев под заказ

Модель	ISO 7025/2 DIN2501	Всасывающий фланец						Напорный фланец					
		DN	D (мм)	T (мм)	K (мм)	d2 (мм)	n	DN	D (мм)	T (мм)	K (мм)	d2 (мм)	n
NSC125-80-210	PN16	125	250	26	210	19	8	80	200	22	160	19	8
NSC125-80-270													
NSC125-80-350													
NSC150-100-250	PN16	150	285	26	240	23	8	100	220	24	180	19	8
NSC150-100-320													
NSC150-100-400													
NSC200-125-240	PN16	200	340	30	295	23	12	125	250	26	210	19	8
NSC200-125-300													
NSC200-125-380													
NSC200-125-480													
NSC200-150-290	PN16	200	340	30	295	23	12	150	285	26	240	23	8
NSC200-150-360													
NSC200-150-460													
NSC200-150-570													
NSC250-200-250	PN16	250	405	32	355	28	12	200	340	30	295	23	12
NSC250-200-340													
NSC250-200-430													
NSC250-200-530													
NSC250-200-660	PN25	250	425	36	370	31	12	200	360	34	310	28	12
NSC300-250-270	PN16	300	460	32	410	28	12	250	405	32	355	28	12
NSC300-250-280													
NSC300-250-390													
NSC300-250-490													
NSC300-250-610													
NSC300-250-780	PN40	300	515	50	450	34	16	250	450	46	385	34	12
NSC350-300-310	PN16	350	520	36	470	28	16	300	460	32	410	28	12
NSC350-300-330													
NSC350-300-400													
NSC400-300-450	PN16	400	580	38	525	31	16	300	460	32	410	28	12
NSC400-300-570													
NSC400-300-700	PN25	400	620	48	550	37	16	300	485	40	430	31	16
NSC400-350-360	PN16	400	580	38	525	31	16	350	520	36	470	28	16
NSC400-350-380													
NSC400-350-520													
NSC450-450-350	PN10	450	615	32	565	28	20	450	615	35	565	28	20
NSC500-400-400	PN10	500	670	34	620	28	20	400	565	32	515	28	16
NSC500-400-420													
NSC500-400-430													
NSC500-400-590													
NSC500-400-675													
NSC500-300-780	PN40	500	755	64	670	42	20	300	515	50	450	33	16
NSC500-300-920	PN25	500	730	56	660	36	20	300	485	38	430	30	16
NSC500-400-500	PN16	500	715	42	650	34	20	400	580	38	525	31	16
NSC500-400-540													
NSC500-400-660	PN25	500	730	52	660	37	20	400	620	48	550	37	16
NSC600-400-740	PN16	600	840	48	770	37	20	400	580	38	525	31	16
NSC600-400-850													
NSC600-400-1050	PN25	600	845	56	770	40	20	400	620	48	550	37	16

Модель	ISO 7025/2 DIN2501	Всасывающий фланец						Напорный фланец					
		DN	D (мм)	T (мм)	K (мм)	d2 (мм)	n	DN	D (мм)	T (мм)	K (мм)	d2 (мм)	n
NSC600-500-470	PN10	600	780	36	725	31	20	500	670	34	620	28	20
NSC600-500-520													
NSC600-500-550													
NSC600-500-580													
NSC700-500-670	PN10	700	895	40	840	31	24	500	670	34	620	28	20
NSC700-500-940	PN25	700	960	60	875	43	24	500	730	52	660	37	20
NSC700-500-1150													
NSC700-600-600	PN10	700	895	40	840	31	24	600	780	36	725	31	20
NSC700-600-680													
NSC700-600-740	PN16	700	910	54	840	36	24	600	840	48	770	37	20
NSC700-700-500	PN10	700	895	40	840	31	24	700	895	40	840	31	24
NSC800-600-1150	PN16	800	1025	58	950	40	24	600	840	48	770	37	20
NSC800-600-1430	PN25	800	1085	60	990	49	24	600	845	56	770	40	20
NSC800-700-750	PN10	800	1015	44	950	34	24	700	895	40	840	31	24
NSC800-700-910	PN16	800	1015	44	950	34	24	700	910	54	840	36	24
NSC900-700-1250	PN16	900	1125	62	1050	40	28	700	910	54	840	37	24
NSC900-700-1550	PN25	900	1185	62	1090	49	28	700	960	58	875	43	24
NSC900-800-840	PN10	900	1115	46	1050	33	28	800	1015	44	950	34	24
NSC900-800-990	PN16	900	1125	62	1050	40	28	800	1025	58	950	40	24
NSC1000-800-940	PN10	1000	1230	50	1160	36	28	800	1015	44	950	34	24
NSC1000-800-1160	PN16	1200	1255	66	1170	43	28	800	1025	58	950	40	24
NSC1000-800-1500													
NSC1200-1000-1100	PN10	1200	1455	56	1380	40	32	1000	1230	50	1160	37	28
NSC1200-1000-1400													
NSC1200-1000-1750	PN16	1200	1485	68	1390	49	32	1000	1255	66	1170	43	28
NSC1400-1200-1300	PN10	1400	1675	62	1590	43	36	1200	1455	56	1380	40	32
NSC1400-1200-1650													

Примечание: Если требуются фланцы, соответствующие BS4504, ANSI B16.1 или другим стандартам, пожалуйста, сообщите. Если необходим насос с размерами, не указанными в таблице, свяжитесь с CNP.

Горизонтальные насосы NSC с размерами двигателя (Стандарт)

Направление вращения: по часовой стрелке

Единицы: мм, если не указано другое

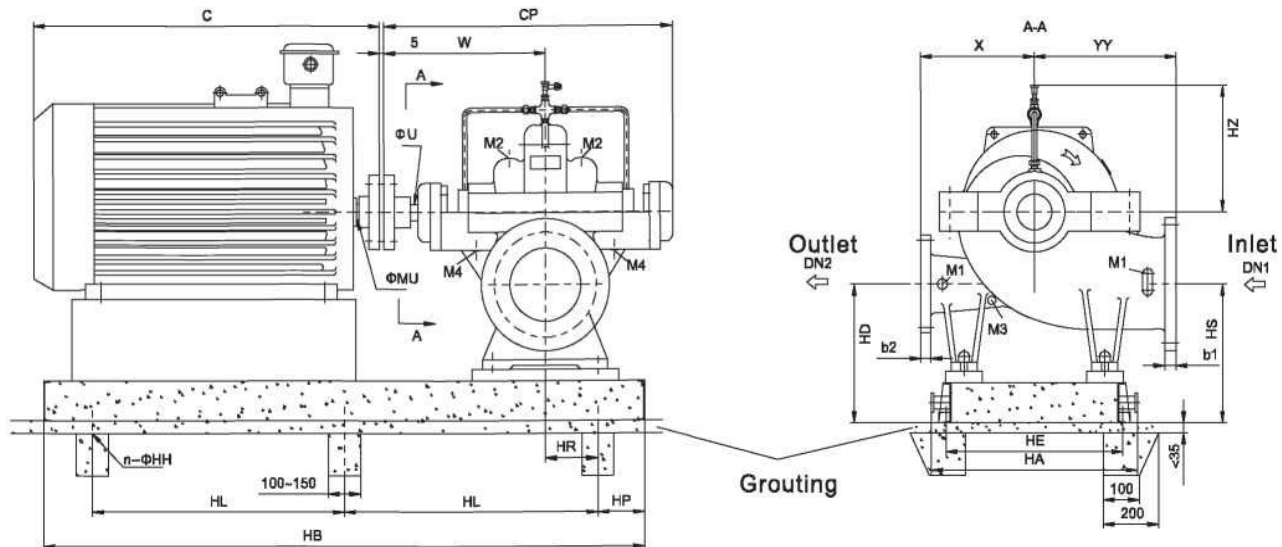

После выравнивания фундамента плиты основания с безусадочным бетоном, расположите клеммную коробку в соответствии со стандартом двигателя. Подключите трубы без давления.

Подключения

M1: Манометр G1/2 M2: Вентиль G1/2 M3: Дренаж G1/2 M4: Отвод утечки G3/4

Размеры—Горизонтальное расположение (1/5)

Единицы: мм, если не указано другое

Модель	Обороты r/min	Мощность kW	Двигатель	Тип насоса и плита основания														Вес пустого (кг)																		
				W	CP	X	Y	HD/HS	H	h1	H1	C	HB	HL	HE	HR	n	d	Pump	Motor	Baseplate	Total														
NSC125-80-210	1480	3	100L	441	789	300	300	305	725	455	675	525	437	1000	390	370	80	6	20	180	38	68.5	286.5													
		4	112M									555	472	1020	390	370	80			180	45	69	294													
		5.5	132S									600	512	1040	390	370	80			180	71	68	319													
	2980	15	160M									675	672	1160	450	370	80			180	131	73	384													
		18.5	160L									702	1190	450	370	80	180			145	75	400														
		22	180M									710	742	1210	450	370	80			180	180	75.5	435.5													
		30/37	200L									760	792	1240	480	370	80			180	258	77.5	515.5													
		45	225M									815	857	1270	500	380	80			180	320	80	580													
		NSC125-80-270	1480									4	112M	441	789	300	300			305	725	455	600	555	472	1020	400	370	80	6	20	185	45	69	299	
												5.5	132S											600	512	1040	410	370	80			185	71	68	324	
7.5	132M			675	702	1160	480	370	80	185	80	71	336																							
11	160M			742	1190	480	370	80	185	131	73	389																								
2980	15		160L	760	792	1240	500	370	80	185	145	75	405																							
	30/37		200L	815	857	1270	530	380	80	185	245	77.5	507.5																							
	45		225M	870	917	1360	580	440	80	185	365	90	640																							
	55		250M	935	987	1410	600	500	80	185	559	92	836																							
	75		280S	935	1037	1460	630	500	80	185	602	96	883																							
	90		280M	NSC125-80-350	1480	11	160M	441	789	330	330	315	828					455	675					702	1160	460	370	80	6			25	205	131	74	410
15	160L	742	1190			480	370							80	205	145	76		426																	
18.5	180M	730	697			1210	500							370	80	205	180		77	462																
22	180L	732	1240			520	370							80	205	196	79		480																	
NSC150-100-250	1480	5.5	132S		441	789	330							330	325	823	495		600	512	1040	430	430	80	6	25	220	61		76	357					
		7.5	132M																	675	702	1160	460	430			80	220		73	79		372			
		11	160M																	742	1190	480	430	80			220	103		81	404					
		15	160L																	815	857	1270	530	430			80	220		130	83		433			
	2980	45	225M																	870	917	1360	560	490			80	220		322	89		631			
		55	250M																	935	987	1410	600	510			80	220		410	98		728			
		75	280S	935				1037	1460	630	510	80	220					555		99.5	874.5															
		90	280M	1100				1122	1500	640	580	80	220					610		103	933															
		110	315S	NSC150-100-320				1480	11	160M	441	789	330					330		325	837	495	675	702			1160	460	430	80	6	25	235	103	81	419
		15	160L						742	1190													480	430			80	235	130	83			448			
18.5	180M	730	697		1210	500	430		80	235				165	83	483																				
22	180L	742	1240		500	430	60		235	180				86	501																					
2980	30	200L	760		792	1240	500	430	80	235				238	85	558																				
	75	280S	935		987	1410	600	520	80	235				555	100	890																				
	90	280M	1037		1460	630	520	80	235	610				104	949																					
	110	315S	1100		1122	1500	640	600	80	235				750	115	1100																				
	132	315M	1332		1610	700	600	80	235	875				125	1235																					
	NSC150-100-400	1480	15		160L	441	789	370	370	325				855	495	675	658		1190				480	430	80	6	25	245	130	84			459			
18.5			180M	730	697						1210	500	430				80	245	165	84	494															
22			180L	732	1240						500	430	80				245	180	86	511																
30			200L	760	782						1240	500	430				80	245	238	85	568															
2980		37	225S	815	812						1280	530	430				80	245	298	86	629															
		45	225M	870	807						1300	530	430				80	245	322	90	657															
		55	250M	935	907						1360	580	430				80	245	410	95	750															
		NSC200-125-240	1480	7.5	132M						500	873	370				370	325	840	540	600	512	1190	480	430			120	6	25	295	80	85	460		
11	160M			675	614																	1270	520	430	120			295			103	85	483			
15	160L			730	658																	1300	540	430	120			295			130	90	515			
18.5	180M			730	697	1320	550	430	120	295				165	90	550																				
2980	22		180L	935	732	1360	550	430	120	295				180	92	567																				
	75		280S	1100	972	1530	650	520	120	295				555	111	961																				
	90		280M	1022	1022	1580	650	520	120	295				610	115	1020																				
	110		315S	1122	1122	1620	680	600	120	295				750	128	1173																				
	132		315M	1332	1332	1730	750	600	120	295				875	138	1308																				

Модель	Обороты r/min	Мощность kW	Двигатель	Тип насоса и плита основания														Вес пустого (кг)								
				W	CP	X	Y	HD/HS	H	h1	H1	C	HB	HL	HE	HR	n	d	Pump	Motor	Baseplate	Total				
NSC200-125-300	1480	11	160M	500	873	370	370	340	865	540	675	614	1270	520	480	120	6	25	310	103	90	503				
		15	160L									658	1300	520	480	120			310	130	93	533				
		18.5	180M									697	1320	550	480	120			310	165	93	568				
		22	180L									732	1360	550	480	120			310	180	96	586				
		30	200L									760	1350	550	480	120			310	238	94	642				
		37	225S									815	1390	580	480	120			310	298	94	702				
	2980	90	280M									1100	1022	1580	650	550			120	310	610	117	1037			
		110	315S										1122	1620	680	600			120	310	750	126	1186			
		132	315M										1332	1730	750	600			120	310	875	136	1321			
		160	315L										1332	1730	750	600			120	310	1070	136	1516			
		22	180L										780	732	1340	560			480	120	6	25	350	180	95	625
		30	200L											760	1330	560			480	120			350	238	94	682
37	225S	812	1370	580	480	120	350	298	94	742																
45	225M	837	1400	600	480	120	350	322	99	771																
55	250M	905	1460	620	480	120	350	410	107	867																
75	280S	935	1510	650	490	120	350	555	109	1014																
NSC200-125-480	1480	37	225S	500	873	450	450	340	929	540	780			812	1370	580	590	120	6	25			390	298	100	788
		45	225M											807	1400	580	590	120					390	322	106	818
		55	250M									905		1460	620	590	120	390					410	113	913	
		75	280S									972		1510	650	590	120	390					555	114	1059	
		90	280M									935		1022	1560	650	590	120					390	610	118	1118
		110	315S											1122	1630	690	590	120					390	750	129	1269
		132	315M										1332	1740	740	590	120	390			875	139	1404			
		15	160L										780	658	1300	520	480	120			6	25	330	130	93	553
18.5	180M	697	1320	550	480	120	330	165	93	588																
22	180L	732	1360	550	480	120	330	180	96	606																
30	200L	760	1350	550	480	120	330	238	94	662																
37	225S	812	1390	580	480	120	330	298	94	722																
45	225M	837	1420	580	480	120	330	322	100	752																
NSC200-150-290	1480	30	200L	500	873	400	400	340	880	540	760	782		1350	560	480	120	6	25	365			238	94	697	
37		225S	812									1390		580	480	120	365			298			94	757		
45		225M	807									1420	600	480	120	365	322			100	787					
55		250M	905									1480	620	480	120	365	410			106	881					
75		280S	935									1530	650	540	120	365	555			110	1030					
NSC200-150-360		1480	30									200L	500	873	400	400	340			920	540	760	782	1350	560	480
37	225S		812	1390	580	480	120	460	410	116	986															
45	225M		807	1420	600	480	120	460	555	117	1132															
55	250M		960	1620	700	590	160	460	610	121	1191															
75	280S		1090	1022	1670	720	590	160	460	610	121	1191														
90	280M			1152	1740	760	600	160	460	750	132	1342														
110	315S	1332		1850	800	600	160	460	875	142	1477															
NSC200-150-460	1480	132	315M	570	1008	450	450	360	1010	545	1060	1022	1670	720	730	160	6	25	460	960	142	1562				
		160/200	315L									1332	1850	800	600	160			460	960	142	1562				
		90	280M									1190	1060	1022	1670	720			730	160	670	610	162	1442		
		110	315S										1152	1740	760	730			160	670	750	175	1595			
		132	315M										1332	1850	810	730			160	670	875	187	1732			
		160/200	315L										1522	1980	850	730			160	670	1070	181	1927			
		220/250	355M										1522	1980	850	730			160	670	1690	201	2561			
		280/315	355L										1522	1980	850	730			160	670	1950	202	2822			
NSC250-200-340	1480	30	200L	570	1008	450	450	420	1090	660	965	782	1450	600	590	160	6	25	478	238	127	843				
		37	225S									812	1490	630	590	160			478	298	127	903				
		45	225M									807	1510	650	590	160			478	322	135	935				
		55	250M									1025	1570	670	590	160			478	410	143	1031				
		75	280S									1060	972	1620	700	590			160	478	555	145	1178			
		90	280M										1022	1670	720	590			160	478	610	150	1238			
		NSC250-200-430	1480										45	225M	570	1008			500	500	420	1120	660	995	807	1510
55	250M	1025		1570	680	590	160	568	410	143	1121															
75	280S	1060		972	1620	700	590	160	568	510	146	1224														
90	280M			1022	1670	720	590	160	568	610	151	1329														
110	315S			1190	1152	1740	760	670	160	568	750	170	1488													
132	315M	1332			1850	820	670	160	568	875	182	1625														
160/200	315L	1332			1850	820	670	160	568	1070	182	1820														
NSC250-200-430	1480	45	225M		570	1008	500	500	420	1120	660	995	807	1510	650	590	160	6	30	568	322	137	1027			
55		250M	1025	1570									680	590	160	568	410			143	1121					
75		280S	1060	972									1620	700	590	160	568			510	146	1224				
90		280M		1022									1670	720	590	160	568			610	151	1329				
110		315S		1190									1152	1740	760	670	160			568	750	170	1488			
132		315M	1332										1850	820	670	160	568			875	182	1625				
160/200	315L	1332	1850	820	670	160	568	1070	182	1820																

Модель	Обороты r/min	Мощность kW	Двигатель	Тип насоса и плита основания														Вес пустого (кг)							
				W	CP	X	Y	HD/HS	H	h1	HI	C	HB	HL	HE	HR	n	d	Pump	Motor	Baseplate	Total			
NSC250-200-530	1480	110	315S	638	1112	500	600	440	1210	740	1270	1152	1810	800	740	160	6	30	710	750	221	1681			
		132	315M									1332	1920	850	740	160			710	875	235	1820			
		160/200	315L									1332	1920	860	740	160			710	1070	235	2015			
		220/250	355M									1395	1522	2040	900	740			160	710	1690	257	2657		
		280/315	355L									1522	2040	900	740	160			710	1950	257	2917			
NSC250-200-660	1480	280/315	355L	638	1112	550	650	430	1305	780	1435	1522	2060	920	740	180	6	30	1020	1950	235	3205			
NSC300-250-270	1480	30	200L	570	1008	450	500	560	1244	760	1065	792	1450	620	600	160	6	25	650	238	134	1086			
		37	225S									812	1490	620	600	160			650	298	133	1228			
		45	225M									1095	807	1510	650	600			160	650	322	145	1252		
		55	250M									1125	907	1570	680	600			160	650	410	151	1340		
		75	280S									1160	972	1620	700	600			160	650	555	154	1485		
		90	280M									1022	1670	720	600	160			650	610	160	1520			
NSC300-250-280	1480	30	200L	570	1008	450	500	560	1244	760	1065	792	1440	620	600	160	6	25	650	238	136	1086			
		37	225S									812	1490	620	600	160			650	298	135	1083			
		45	225M									1095	807	1510	650	600			160	650	322	145	1117		
		55	250M									1125	907	1570	680	600			160	650	410	151	1211		
		75	280S									1160	972	1620	700	600			160	650	555	154	1359		
		90	280M									1022	1670	720	600	160			650	610	160	1520			
NSC300-250-390	1480	75	280S	638	1112	500	500	460	1177	765	1190	972	1690	720	730	160	6	25	668	555	174	1397			
		90	280M									1022	1740	750	730	160			668	610	180	1458			
		110	315S									1290	1152	1810	800	730			160	668	750	194	1612		
		132	315M									1332	1920	830	730	160			668	875	208	1751			
		160/200	315L									1332	1920	830	730	160			668	1080	208	1956			
NSC300-250-490	8014	110	315S	738	1320	550	550	460	1365	785	1310	1152	1970	3-590	740	220	8	30	950	750	238	1938			
		132	315M									1332	2080	3-590	740	220			950	875	253	2078			
		200	315L									1332	2080	3-590	740	220			950	1080	260	2290			
		220/250	355M									1435	1522	2200	3-610	740			220	950	1690	278	2918		
		280/315	355L									1522	2200	3-610	740	220			950	1950	278	3178			
NSC300-250-610	1480	220/250	355M	738	1320	550	650	460	1450	815	1435	1522	2200	3-610	740	220	8	30	1125	1960	286	3371			
		280/315	355L									1522	2200	3-610	740	220			1125	1950	286	3595			
NSC350-300-310	1480	45	225M	638	1112	520	600	490	1255	795	1125	907	1620	700	680	200	6	25	800	410	166	1376			
		55	250M									1155	972	1680	720	680			200	800	555	176	1531		
		75	280S									1190	1022	1730	750	680			200	800	610	179	1589		
		90	280M									1320	1152	1780	750	680			200	800	750	185	1735		
		110	315S									1320	1332	1850	800	690			200	6	30	800	875	202	1877
NSC350-300-330	1480	75	280S	638	1112	520	600	490	1255	795	1190	1022	1730	750	680	200	6	25	800	555	179	1534			
		90	280M									1152	1780	780	680	200			800	610	185	1595			
		110	315S									1320	1152	1850	800	690			200	6	30	800	750	202	1752
		132	315M									1320	1332	1960	850	690			200	6	30	800	875	217	2045
		160	315L									1332	1960	850	690	200			800	875	217	1892			
NSC400-300-450	1480	132	315M	738	1320	550	650	530	1470	885	1370	1323	2080	3-590	740	220	8	30	1000	875	271	2146			
		160/200	315L									1323	2080	3-590	740	220			1000	1080	271	2351			
		220/250	355M									1535	1522	2200	3-610	740			220	1000	1690	306	2996		
		280/315	355L									1522	2200	3-610	740	220			1000	1950	306	3256			
NSC400-350-360	1480	132	315M	738	1320	570	670	500	1480	855	1340	1332	2130	3-620	700	280	8	30	880	750	263	1893			
		160/200	315L									1332	2140	3-620	700	280			880	875	263	2018			
NSC400-350-380	1480	160/200	315L	738	1320	570	670	500	1480	855	1340	1332	2140	3-620	700	280	8	30	880	875	263	2018			
		220/250	355M									1535	1532	2260	3-670	700			280	880	1080	295	2255		
		280/315	355L									1532	2260	3-670	700	280			880	1680	295	2855			

Примечание: Отклонения размеров и веса в зависимости от выбранного производителя мотора должны быть учтены. Если необходим насос с размерами отсутствующими в таблице, пожалуйста, свяжитесь с CNP.

Размеры вертикального насоса NSC с двигателем (Стандарт)

Направление вращения: По часовой стрелке

- | | | |
|----|-----------------|------|
| M1 | Манометр | G1/2 |
| M2 | Газовый вентиль | G1/2 |
| M3 | Дренаж | G1/2 |
| M4 | Отвод утечки | G3/4 |

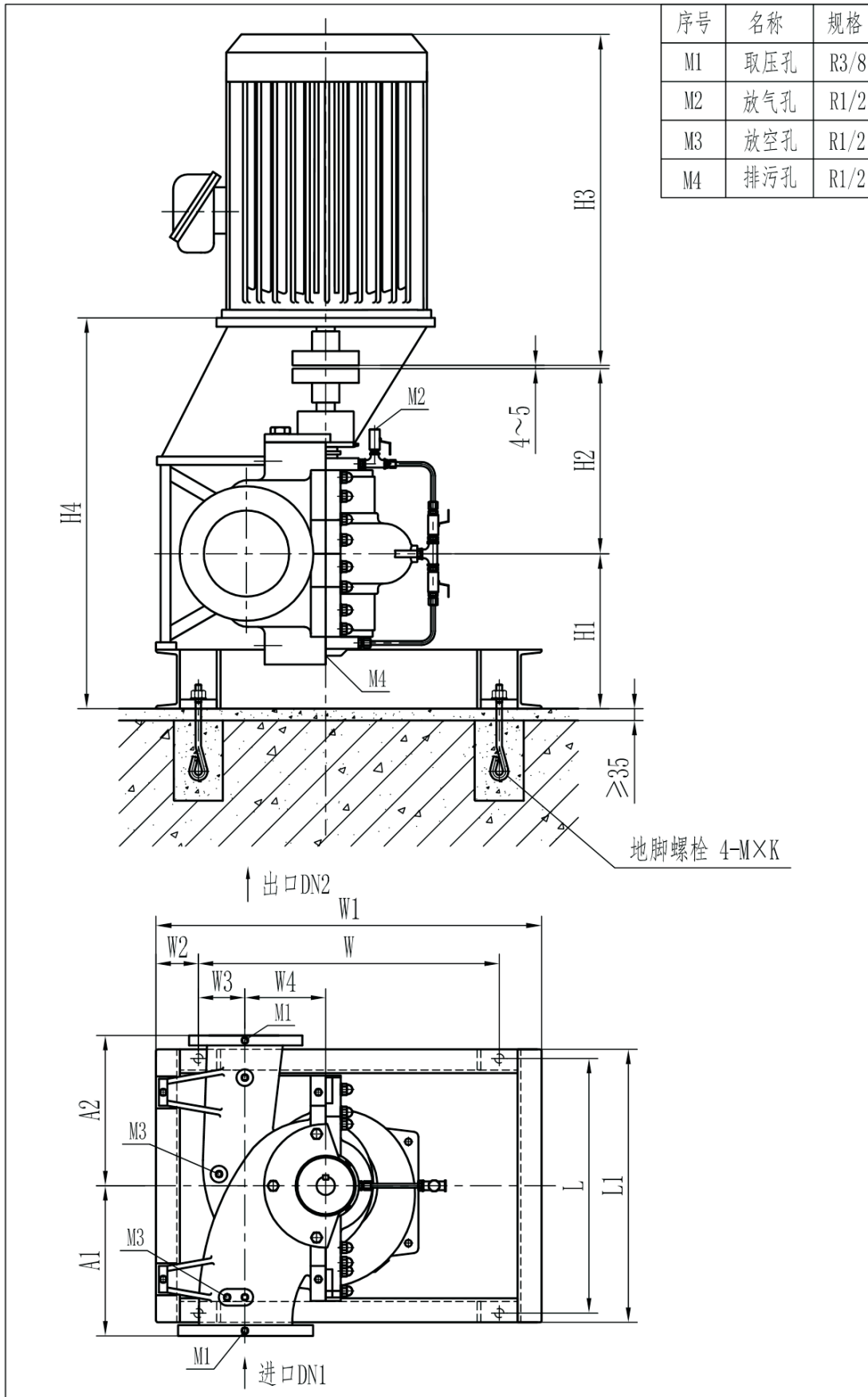

Размеры—Вертикальное расположение

Единицы: мм, если не указано другое

Модель	Двигатель	Мощность (kW)	Размеры																								
			DN1	DN2	A1	A2	H1	H2	H3	H4	W	W1	W2	W3	W4	L	L1	M×K									
NSC125-80-210	min.112M-4	4	125	80	300	300	320	441	470	880	500	700	100	70	150	480	526	M20×400									
	max.132M-4	7.5							560																		
NSC125-80-270	min.132S-4	5.5	125	80	300	300	320	441	510	880	500	700	100	70	150	480	526		M20×400								
	max.160M-4	11							510																		
NSC125-80-350	min.160M-4	11	125	80	300	300	320	441	670	910	500	700	100	80	140	480	526			M20×400							
	max.180L-4	22							670																		
NSC150-100-250	min.132M-4	7.5	150	100	330	330	320	441	560	880	550	780	100	90	170	540	584				M20×400						
	max.160L-4	15							560																		
NSC150-100-320	min.160L-4	15	150	100	330	330	320	441	700	880	550	780	100	90	170	540	584					M20×400					
	max.200L-4	30							700																		
NSC150-100-400	min.200L-4	30	150	100	330	330	320	441	790	880	550	780	100	90	170	540	584						M20×400				
	max.250M-4	55							790																		
NSC200-125-240	min.160L-4	15	125	125	370	370	375	500	700	1030	600	800	125	80	200	530	580							M20×400			
	max.180L-4	22							700																		
NSC200-125-300	min.180M-4	18.5	125	125	370	370	375	500	740	1030	600	800	125	80	200	530	580								M20×400		
	max.200L-4	30							740																		
NSC200-125-380	min.225S-4	37	125	125	395	395	355	500	790	1040	600	820	110	90	200	600	650									M20×400	
	max.280S-4	75							790																		
NSC200-125-480	min.250M-4	55	200	150	450	450	375	560	830	1040	600	820	110	90	200	700	750										M20×400
	max.315S-4	110							830																		
NSC200-150-290	min.180M-4	18.5	200	150	450	450	375	560	915	1070	600	850	125	75	200	700	750	M20×400									
	max.225M-4	45							915																		
NSC200-150-360	min.225M-4	45	200	150	450	450	375	560	1510	1070	600	850	125	75	200	700	750		M20×400								
	max.280M-4	90							1510																		
NSC200-150-460	min.315S-4	110	200	150	450	450	375	560	740	1030	650	900	125	85	300	730	780			M20×400							
	max.315L-4	160							740																		
NSC200-150-570	min.315S-4	160	200	150	600	500	420	560	1620	1190	750	1050	150	60	300	850	900				M24×500						
	max.355L-4	280							1620																		
NSC250-200-340	min.250M-4	55	250	200	450	450	420	560	1780	1160	650	970	160	110	240	730	780					M20×400					
	max.280M-4	90							1780																		
NSC250-200-430	min.315S-4	110	250	200	500	500	420	560	1015	1160	650	970	160	110	240	730	780						M20×400				
	max.315L-4	185							1015																		
NSC250-200-530	min.315L-4	185	250	200	600	500	450	645	1510	1190	800	1110	155	120	300	850	910							M24×500			
	max.355L-4	315							1510																		
NSC300-250-280	min.250M-4	55	300	250	500	450	420	560	1620	1190	700	1100	200	110	300	690	740								M20×400		
	max.280M-4	90							1620																		
NSC300-250-390	min.315S-4	110	300	250	500	500	430	645	1510	1290	850	1150	140	160	300	850	910									M20×400	
	max.315L-4	185							1510																		
NSC350-300-330	min.315S-4	110	350	300	600	520	470	645	1620	1330	900	1200	150	190	300	800	860										M24×500
	max.315L-4	160							1620																		
NSC350-300-400	min.315L-4	160	350	300	630	560	490	705	1780	1410	900	1180	140	180	320	900	960	M24×500									
	max.355M-4	250							1780																		

Примечание: Отклонения размеров и веса в зависимости от выбранного производителя мотора должны быть учтены. Если необходим насос с размерами отсутствующими в таблице, пожалуйста, свяжитесь с CNP.

Рекомендованные запчасти

1. Рекомендованные запчасти для ввода в эксплуатацию.

Набивной сальник

№. Детали	Наименование (Комплект)	Количество насосов включая резервные				
		1	2	3	4	5
		Количество запчастей				
02.11.003 02.13.001 02.13.002	Набивка сальника Уплотнительные кольца круглого сечения Уплотнительные кольца с кромкой	1	2	3	4	5

Механическое уплотнение

№. Детали.	Наименование (Комплект)	Количество насосов включая резервные				
		1	2	3	4	5
		Количество запчастей				
02.08.001 04.02.017	Шариковый подшипник с глубокими пазами (желобами) Пружинный стопор подшипника	1	2	3	4	5
02.13.001 02.13.002	Уплотнительное кольцо круглого сечения Уплотнительное кольцо с кромкой	1	2	3	4	5
02.13.004	Механическое уплотнение	1	2	3	4	5

2. Рекомендуемые запчасти (на комплект) для 2 лет эксплуатации (8000 часов в год)

Набивной сальник

№ Детали	Наименование	Количество насосов включая резервные				
		1	2	3	4	5
		Количество запчастей				
04.02.021 04.02.019 02.03.004 02.05.001	Вал Втулка подшипника Круглая шлицевая гайка Пружинное стопорное кольцо	-	-	-	1	1
04.02.004	Рабочее колесо	1	2	2	2	2
02.08.001 04.02.017	Шариковый подшипник с глубокими желобами Пружинный стопор подшипника	1	1	1	2	2
04.09.005	Сальник	-	-	-	1	1
02.13.001 02.13.002	Уплотнительное кольцо круглого сечения Уплотнительное кольцо с кромкой	1	2	3	4	5
02.11.003	Набивка сальника	4	8	12	16	20
04.02.012	Комплект горловинных колец	-	-	-	1	1
04.09.002	Фонарное кольцо	-	-	-	1	1
04.09.001	Компенсационное кольцо	1	1	1	2	2
02.12.004	Сальник	1	1	1	2	2
04.02.022	Втулка вала	1	1	1	2	2

Торцевое уплотнение

№ Детали	Наименование (Комплект)	Количество насосов включая резервные				
		1	2	3	4	5
04.02.021 04.02.019 02.03.004 02.05.001	Вал Втулка подшипника Круглая шлицевая гайка Пружинное стопорное кольцо	-	-	-	1	1
04.02.004	Рабочее колесо	1	2	2	2	2
02.08.001 04.02.017	Шариковый подшипник с глубокими желобами Пружинный стопор подшипника	1	1	1	2	2
02.13.001 02.13.002	Уплотнительное кольцо круглого сечения Уплотнительное кольцо с кромкой	1	2	3	4	5
02.13.004	Механическое уплотнение	1	1	1	2	2
04.09.001	Компенсационное кольцо	1	1	1	2	2
02.12.004	Сальник	1	1	1	2	2
04.02.023	Втулка вала	1	1	1	2	2

Комплектация

- Насос со свободным концом вала: чаще горизонтальная или вертикальная конструкция, с финишным покрытием, грунтовкой и сальником с мягкой набивкой или торцевым уплотнением.
- Дополнительно приобретается: - подшипники, смазываемые маслом - покрытие пригодное для питьевой воды - Горизонтальная опорная плита для насоса и двигателя - кронштейн двигателя для вертикальной установки - крепление двигателя - специальная обработка покрытия - испытания в присутствии заказчика
- Дополнительно приобретается для аксессуаров: — Муфта с защитным кожухом - Комплект манометров - Комплект уплотнителей для труб - Вентиляционный клапан - Датчик температуры для подшипников (Pt100)

Гарантия, проверка и контроль качества

- Каждый насос проходит функциональное тестирование и эксплуатационные данные гарантируются без приемочного испытания. За дополнительную плату выполняется тестирование при заказе.
- Приёмочные испытания могут проводиться в соответствии с IS09906, GB3216C или другим сопоставимым стандартом тестирования.
- Качество продукции CNP подтверждается Системой менеджмента качества DIN ISO 9001.

Данные для заказа

Насос

1. Обозначение насоса согласно разделу «Обозначение»	6. Уплотнение вала набивной сальник или торцевой уплотнитель
2. Производительность Q	7. Для какой жидкости и температуры
3. Общая высота подъема (напор) H	8. Направление вращения / расположение мотора
4. Комбинация материалов	9. Необходимые аксессуары
5. Стандарт фланцев	10. Количество и язык руководств по эксплуатации.

Двигатель (Заполняется CNP)

1. Защита	4. Необходимы аксессуары
2. Напряжение, частота, способ запуска	5. Класс изоляции
3. Внешняя температура	6. Прочее
Примечание: При использовании клиентом своего двигателя, пожалуйста приложите его чертеж и техническую документацию.	

